

RL78/G23

Achieving a Watchdog Timer by Using the SNOOZE Mode Sequencer

Introduction

This application note describes how to achieve a watchdog timer function by using the SNOOZE mode sequencer (SMS) of an RL78/G23.

The SNOOZE mode sequencer can perform processing independently of the CPU. The SNOOZE mode sequencer runs a counter as a watchdog timer function. If the counter overflows before the CPU clears the counter, the SNOOZE mode sequencer generates an interrupt request. The interrupt request allows the CPU to detect that the counter was not cleared.

Target Device

RL78/G23

When applying the sample program covered in this application note to another microcomputer, modify the program according to the specifications for the target microcomputer and conduct an extensive evaluation of the modified program.

Contents

1. Specification	3
1.1 Overview of Specification	3
1.2 Outline of Operation	4
2. Operation Confirmation Conditions	5
3. Hardware Descriptions	6
3.1 Example of Hardware Configuration	6
3.2 List of Pins to be Used	6
4. Software Explanation	7
4.1 Setting of Option Byte	7
4.2 List of Constants	7
4.3 List of Variables	7
4.4 List of Functions	8
4.5 Specification of Functions	8
4.6 Flowcharts	9
4.6.1 Main Processing	9
4.6.2 Main Initial Settings	10
4.6.3 SNOOZE Mode Sequencer Activation	11
4.6.4 INTSMSE Interrupt Processing	12
4.7 Setting Up the SNOOZE Mode Sequencer	13
5. Sample Code	15
6. Reference Documents	15
Revision History	16

1. Specification

1.1 Overview of Specification

This application note describes how to achieve a watchdog timer function by using the SNOOZE mode sequencer of an RL78/G23.

The SNOOZE mode sequencer runs a counter as a watchdog timer function. The CPU periodically clears the counter so that the counter does not overflow.

The CPU stops clearing the counter when a switch is pressed. When one second elapses after counter clearance is stopped, the counter overflows and the SNOOZE mode sequencer generates an interrupt request. When the CPU detects the interrupt request, it turns on an LED.

Table 1-1 shows the peripheral functions to be used and Figure 1-1 shows an overview of operation.

Table 1-1 Peripheral Function and Use

Peripheral Function	Use
External interrupt (INTP3)	Triggers starting the SNOOZE mode sequencer.
SNOOZE mode sequencer	Runs a counter as a watchdog timer function and generates an interrupt request.

Figure 1-1 Operation overview

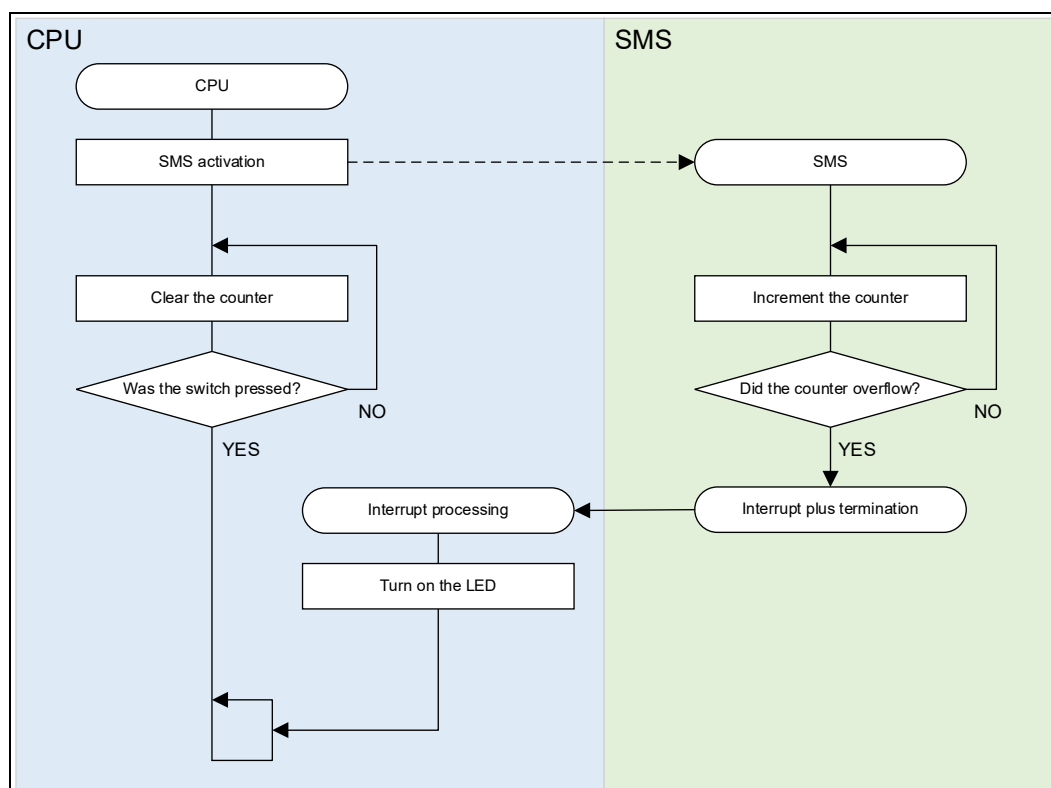

1.2 Outline of Operation

In this sample code, a low-level pulse is output from the P30 pin to generate an external interrupt request (INTP3). This external interrupt request triggers start of the SNOOZE mode sequencer. The SNOOZE mode sequencer increments the counter and judges whether an overflow has occurred. The CPU repeats clearance of the counter so that the counter does not overflow.

The CPU stops clearing the counter when a switch is pressed. The SNOOZE mode sequencer continues to increment the counter, and then a counter overflow occurs when one second elapses. If an overflow occurs, the SNOOZE mode sequencer generates an interrupt request (INTSMSE). When the CPU detects this interrupt, it turns on an LED.

The following describes the major settings of the peripheral functions.

(1) Initial settings of the external interrupt

- Set the INTP3 pin so that the falling edge is the effective edge.
- Set the P30 pin for output (as a trigger to start the SNOOZE mode sequencer).

(2) Initial settings of the SNOOZE mode sequencer

For details about the values to be set, see "4.7 Setting Up the SNOOZE Mode Sequencer".

2. Operation Confirmation Conditions

The operation of the sample code provided with this application note has been tested under the following conditions.

Table 2-1 Operation Confirmation Conditions

Item	Description
MCU used	RL78/G23 (R7F100GLG)
Board used	RL78/G23 Fast Prototyping Board (RTK7RLG230CLG000BJ)
Operating frequency	<ul style="list-style-type: none"> ● High-speed on-chip oscillator clock (f_{IH}): 32 MHz ● Low-speed on-chip oscillator clock (f_{IL}): 32.768 kHz ● CPU/peripheral hardware clock: 32 MHz
Operating voltage	During V_{DD} operation: 3.3 V LVD0 detection voltage: Reset mode At rising edge TYP. 1.90 V (1.84 V to 1.95 V) At falling edge TYP. 1.86 V (1.80 V to 1.91 V)
Integrated development environment (CS+)	CS+ V8.07.00 from Renesas Electronics Corp.
C compiler (CS+)	CC-RL V1.11.00 from Renesas Electronics Corp.
Integrated development environment (e2studio)	e2 studio V2022-04 (22.4.0) from Renesas Electronics Corp.
C compiler (e2studio)	CC-RL V1.11.00 from Renesas Electronics Corp.
Integrated development environment (IAR)	IAR Embedded Workbench for Renesas RL78 V4.21.1 from IAR Systems Corp.
C compiler (IAR)	IAR C/C++ Compiler for Renesas RL78 V4.21.2.2420 from IAR Systems Corp.

3. Hardware Descriptions

3.1 Example of Hardware Configuration

Figure 3-1 shows an example of the hardware configuration used in the application note.

Figure 3-1 Hardware Configuration

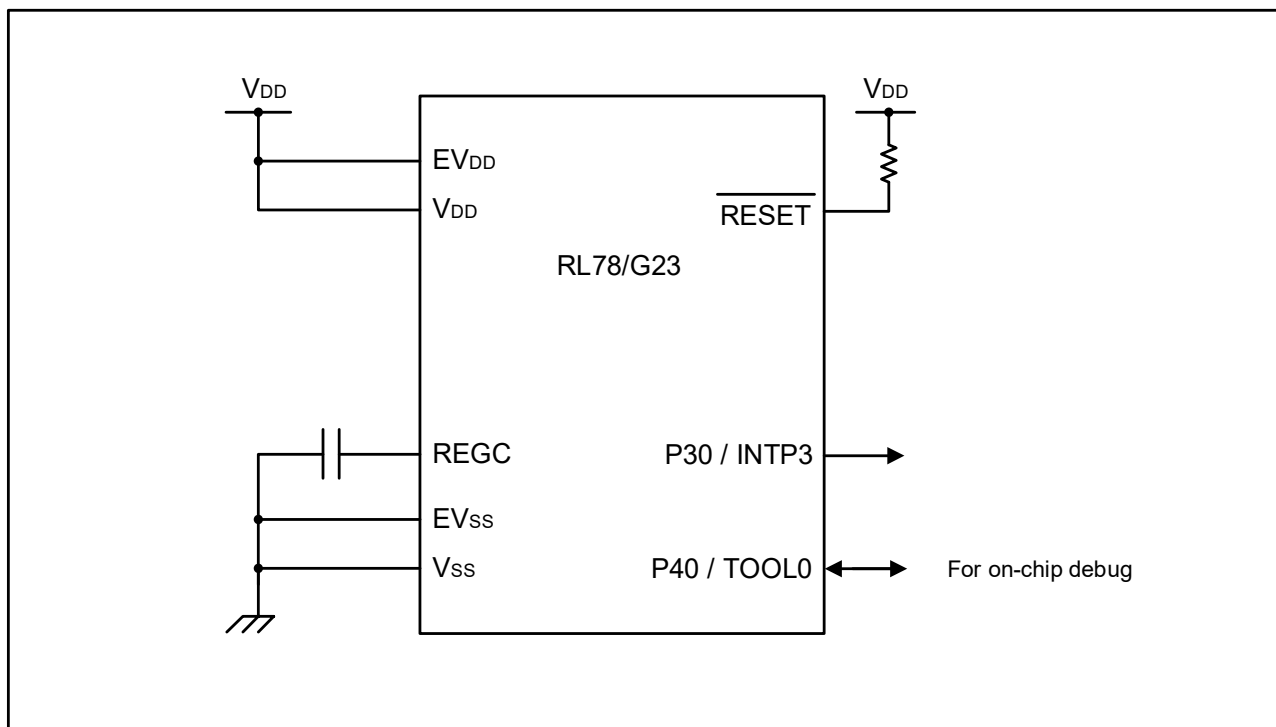

Note 1. This schematic circuit diagram is simplified to show the outline of connections. When creating circuits, design them so that they meet electrical characteristics by properly performing pin processing. (Connect input-only ports to V_{DD} or V_{SS} individually through a resistor.)

Note 2. Connect pins (with a name beginning with EV_{SS}), if any, to V_{SS}, and connect pins (with a name beginning with EV_{DD}), if any, to V_{DD}.

3.2 List of Pins to be Used

Table 3-1 lists the pins to be used and their functions.

Table 3-1 Pins to be Used and Their Functions

Pin name	I/O	Function
P30 / INTP3	Output	SNOOZE mode sequencer activation trigger

In this application note, the P30 and INTP3 pins, which are used as external interrupts, are set for output. This is because the high/low level of the output from the P30 pin is controlled by using a CPU instruction to generate an external interrupt request (from the INTP3 pin) that triggers the SNOOZE mode sequencer.

Caution In this application note, only the used pins are processed. When actually designing your circuit, make sure the design includes sufficient pin processing and meets electrical characteristic requirements.

4. Software Explanation

4.1 Setting of Option Byte

Table 4-1 shows the option byte settings.

Table 4-1 Option Byte Settings

Address	Setting Value	Contents
000C0H / 040C0H	11101111B	Disables the watchdog timer. (Counting stopped after reset)
000C1H / 040C1H	11111110B	LVD0 detection voltage: Reset mode At rising edge TYP. 1.90 V (1.84 V ~ 1.95 V) At falling edge TYP. 1.86 V (1.80 V ~ 1.91 V)
000C2H / 040C2H	11101000B	HS mode, High-speed on-chip oscillator clock (f_{IH}): 32 MHz
000C3H / 040C3H	10000100B	Enables on-chip debugging

4.2 List of Constants

Table 4-2 Constants lists the constants that are used in the sample code.

Table 4-2 Constants

Constant Name	Setting Value	Description
COUNTER_CLEAR	0x0000	Counter clear value
COUNTER_VALUE	0x00FA	Counter compare value (1 second setting value)

4.3 List of Variables

Table 4-3 lists global variables.

Table 4-3 Global Variables

Type	Variable Name	Description	Function Used
*(volatile __near unsigned short *) 0x3C2	p_sms_counter	Sequencer general-purpose register1 (SMSG1)	main r_main_user_init
*(volatile __near unsigned short *) 0x3C6	p_sms_count_value	Sequencer general-purpose register3 (SMSG3)	main r_main_user_init

4.4 List of Functions

Table 4-4 shows a list of functions.

Table 4-4 Functions

Function Name	Outline
main()	Main processing
r_main_user_init()	Main initial settings
r_main_sms_trigger()	SNOOZE mode sequencer activation
r_Config_SMS_interrupt()	INTSMSE interrupt processing

4.5 Specification of Functions

The function specifications of the sample code are shown below.

main()	
Outline	Main processing
Header	r_cg_macrodriver.h、Config_INTC.h、Config_SMS.h、r_cg_userdefine.h
Declaration	void main(void);
Description	This function periodically clears the counter until a switch is pressed.
Argument	None
Return Value	None
r_main_user_init()	
Outline	Main initial settings
Header	r_cg_macrodriver.h、Config_INTC.h、Config_SMS.h、r_cg_userdefine.h
Declaration	static void r_main_user_init(void);
Description	This function specifies the initial settings for the peripheral functions that are used for the application.
Argument	None
Return Value	None
r_main_sms_trigger ()	
Outline	SNOOZE mode sequencer activation
Header	r_cg_macrodriver.h、Config_INTC.h、Config_SMS.h、r_cg_userdefine.h
Declaration	static void r_main_sms_trigger(void);
Description	This function generates a trigger to start the SNOOZE mode sequencer.
Argument	None
Return Value	None
r_Config_SMS_interrupt ()	
Outline	INTSMSE interrupt processing
Header	Config_SMS.h
Declaration	#pragma interrupt r_Config_SMS_interrupt(vect=INTSMSE)
Description	This function turns on an LED.
Argument	None
Return Value	None

4.6 Flowcharts

4.6.1 Main Processing

Figure 4-1 show flowcharts of the main processing.

Figure 4-1 Main Processing

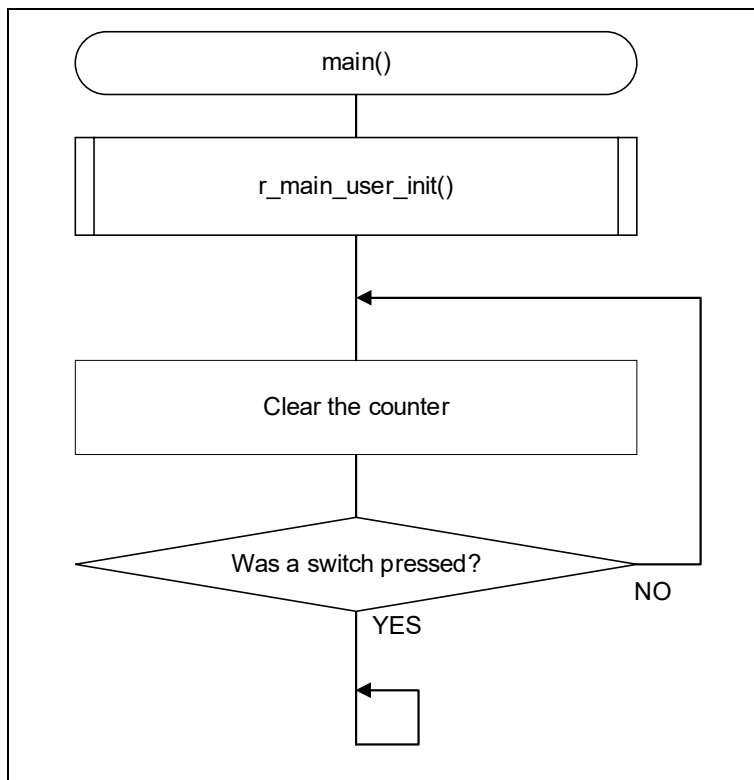

4.6.2 Main Initial Settings

Figure 4-2 shows the flowchart of the initial settings for main functions.

Figure 4-2 Main Initial Settings

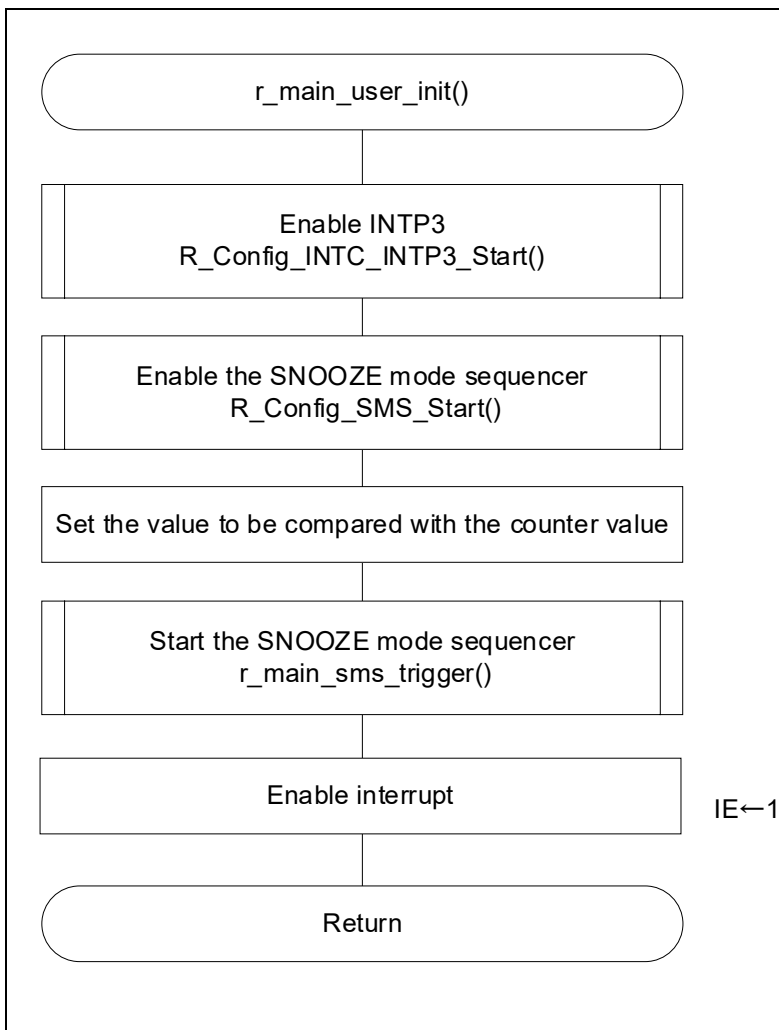

4.6.3 SNOOZE Mode Sequencer Activation

Figure 4-3 shows the flowchart of the SNOOZE mode sequencer activation.

Figure 4-3 SNOOZE Mode Sequencer Activation

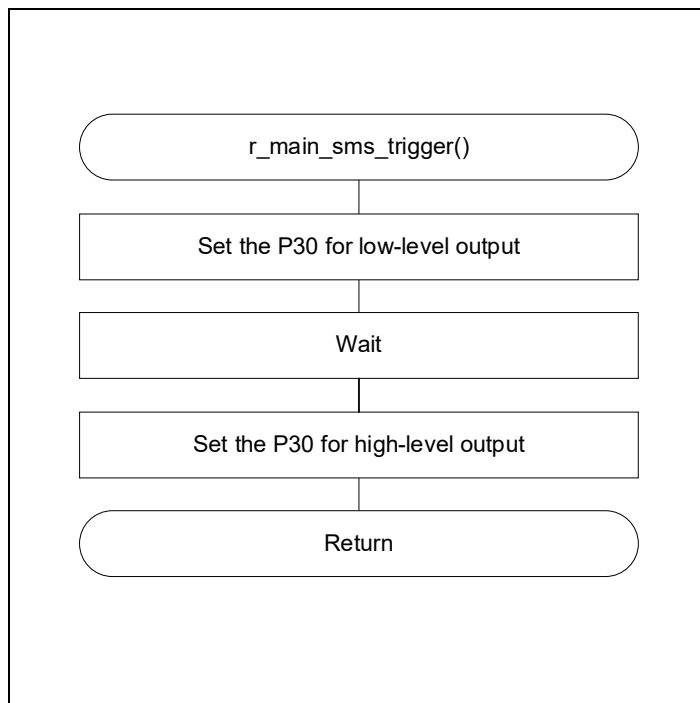

4.6.4 INTSMSE Interrupt Processing

Figure 4-4 shows the flowchart of the INTSMSE interrupt processing.

Figure 4-4 INTSMSE Interrupt Processing

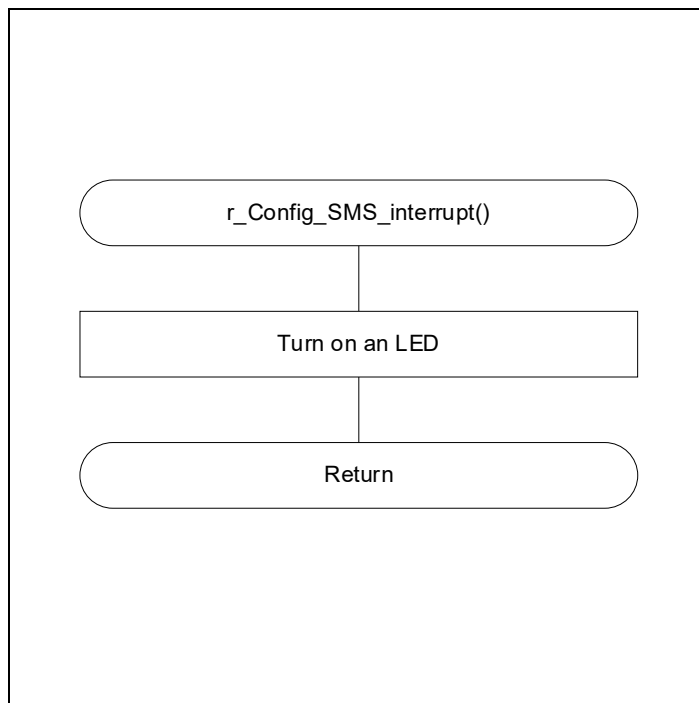

4.7 Setting Up the SNOOZE Mode Sequencer

When the SNOOZE mode sequencer (SMS) is started by occurrence of a triggering event, it sequentially executes the processing commands that are stored in the sequencer instruction register (SMSI0-31). During execution of these commands, the sequencer general-purpose register (SMSG0-15) is used to store the source address, destination address, arithmetic data, and other data.

The SMSI0-31 and SMSG0-15 registers are set by coding an SMS program (.SMSASM file) in assembly language. You can also use the SNOOZE Mode Sequencer component of Smart Configurator to create an SMS program by combining processing blocks. The created SMS program is converted into C language by the assembler for SMS and then incorporated into the application program.

Figure 4-5 shows a flowchart of the processing of the SNOOZE mode sequencer.

Figure 4-5 Processing of the SNOOZE Mode Sequencer

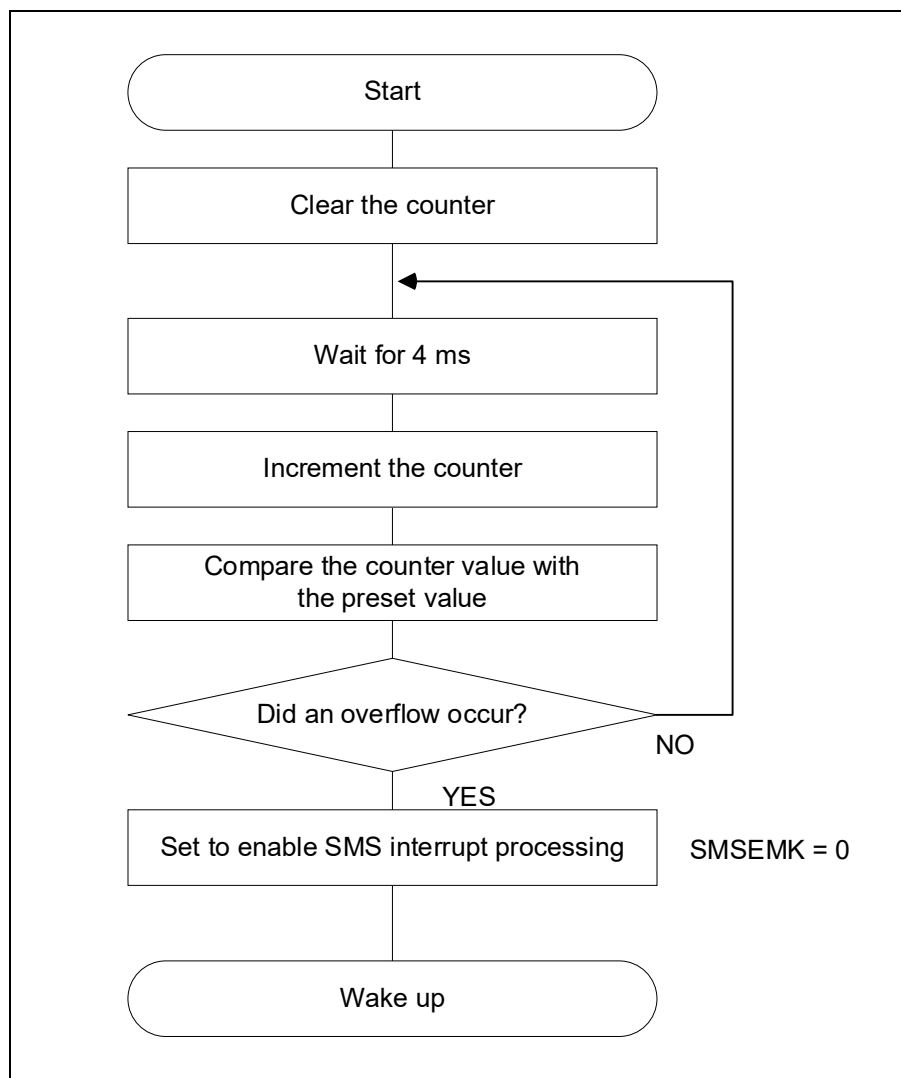

Table 4-1 Sequencer general-purpose registers 0-15

Register Symbol	Setting	Remark
SMSG0	0000H	fixed value: 0000H
SMSG1	0000H	Counter
SMSG2	0001H	Increment value
SMSG3	0000H	Compare value
SMSG4	03C0H	SMSG0 address
SMSG5	FFE5H	MK0H address
SMSG6	0000H	unused
SMSG7	0000H	unused
SMSG8	0000H	unused
SMSG9	0000H	unused
SMSG10	0000H	unused
SMSG11	0000H	unused
SMSG12	0000H	unused
SMSG13	0000H	unused
SMSG14	0000H	unused
SMSG15	FFFFH	fixed value: FFFFH

Table 4-2 Sequencer instruction registers 0-31

Register Symbol	Setting	Remark
SMSI0	3410H	MOVW SMSG1, [SMSG4+0]
SMSI1	9C21H	WAIT 194, 1
SMSI2	7120H	ADDW SMSG1, SMSG2
SMSI3	7312H	CMPW SMSG3, SMSG1
SMSI4	8FD1H	BNC \$1
SMSI5	5540H	CLR1 SMSG5.4
SMSI6	F001H	WAKEUP
SMSI7~31	0000H	unused

5. Sample Code

Sample code can be downloaded from the Renesas Electronics website.

6. Reference Documents

RL78/G23 User's Manual: Hardware (R01UH0896)

RL78 family user's manual software (R01US0015)

The latest versions can be downloaded from the Renesas Electronics website.

Technical update

The latest versions can be downloaded from the Renesas Electronics website.

All trademarks and registered trademarks are the property of their respective owners.

Revision History

Rev.	Date	Description	
		Page	Summary
1.00	2022.06.17	-	First Edition

General Precautions in the Handling of Microprocessing Unit and Microcontroller Unit Products

The following usage notes are applicable to all Microprocessing unit and Microcontroller unit products from Renesas. For detailed usage notes on the products covered by this document, refer to the relevant sections of the document as well as any technical updates that have been issued for the products.

1. Precaution against Electrostatic Discharge (ESD)

A strong electrical field, when exposed to a CMOS device, can cause destruction of the gate oxide and ultimately degrade the device operation. Steps must be taken to stop the generation of static electricity as much as possible, and quickly dissipate it when it occurs. Environmental control must be adequate. When it is dry, a humidifier should be used. This is recommended to avoid using insulators that can easily build up static electricity.

Semiconductor devices must be stored and transported in an anti-static container, static shielding bag or conductive material. All test and measurement tools including work benches and floors must be grounded. The operator must also be grounded using a wrist strap. Semiconductor devices must not be touched with bare hands. Similar precautions must be taken for printed circuit boards with mounted semiconductor devices.

2. Processing at power-on

The state of the product is undefined at the time when power is supplied. The states of internal circuits in the LSI are indeterminate and the states of register settings and pins are undefined at the time when power is supplied. In a finished product where the reset signal is applied to the external reset pin, the states of pins are not guaranteed from the time when power is supplied until the reset process is completed. In a similar way, the states of pins in a product that is reset by an on-chip power-on reset function are not guaranteed from the time when power is supplied until the power reaches the level at which resetting is specified.

3. Input of signal during power-off state

Do not input signals or an I/O pull-up power supply while the device is powered off. The current injection that results from input of such a signal or I/O pull-up power supply may cause malfunction and the abnormal current that passes in the device at this time may cause degradation of internal elements. Follow the guideline for input signal during power-off state as described in your product documentation.

4. Handling of unused pins

Handle unused pins in accordance with the directions given under handling of unused pins in the manual. The input pins of CMOS products are generally in the high-impedance state. In operation with an unused pin in the open-circuit state, extra electromagnetic noise is induced in the vicinity of the LSI, an associated shoot-through current flows internally, and malfunctions occur due to the false recognition of the pin state as an input signal become possible.

5. Clock signals

After applying a reset, only release the reset line after the operating clock signal becomes stable. When switching the clock signal during program execution, wait until the target clock signal is stabilized. When the clock signal is generated with an external resonator or from an external oscillator during a reset, ensure that the reset line is only released after full stabilization of the clock signal. Additionally, when switching to a clock signal produced with an external resonator or by an external oscillator while program execution is in progress, wait until the target clock signal is stable.

6. Voltage application waveform at input pin

Waveform distortion due to input noise or a reflected wave may cause malfunction. If the input of the CMOS device stays in the area between V_{IL} (Max.) and V_{IH} (Min.) due to noise, for example, the device may malfunction. Take care to prevent chattering noise from entering the device when the input level is fixed, and also in the transition period when the input level passes through the area between V_{IL} (Max.) and V_{IH} (Min.).

7. Prohibition of access to reserved addresses

Access to reserved addresses is prohibited. The reserved addresses are provided for possible future expansion of functions. Do not access these addresses as the correct operation of the LSI is not guaranteed.

8. Differences between products

Before changing from one product to another, for example to a product with a different part number, confirm that the change will not lead to problems. The characteristics of a microprocessing unit or microcontroller unit products in the same group but having a different part number might differ in terms of internal memory capacity, layout pattern, and other factors, which can affect the ranges of electrical characteristics, such as characteristic values, operating margins, immunity to noise, and amount of radiated noise. When changing to a product with a different part number, implement a system-evaluation test for the given product.

Notice

1. Descriptions of circuits, software and other related information in this document are provided only to illustrate the operation of semiconductor products and application examples. You are fully responsible for the incorporation or any other use of the circuits, software, and information in the design of your product or system. Renesas Electronics disclaims any and all liability for any losses and damages incurred by you or third parties arising from the use of these circuits, software, or information.
2. Renesas Electronics hereby expressly disclaims any warranties against and liability for infringement or any other claims involving patents, copyrights, or other intellectual property rights of third parties, by or arising from the use of Renesas Electronics products or technical information described in this document, including but not limited to, the product data, drawings, charts, programs, algorithms, and application examples.
3. No license, express, implied or otherwise, is granted hereby under any patents, copyrights or other intellectual property rights of Renesas Electronics or others.
4. You shall be responsible for determining what licenses are required from any third parties, and obtaining such licenses for the lawful import, export, manufacture, sales, utilization, distribution or other disposal of any products incorporating Renesas Electronics products, if required.
5. You shall not alter, modify, copy, or reverse engineer any Renesas Electronics product, whether in whole or in part. Renesas Electronics disclaims any and all liability for any losses or damages incurred by you or third parties arising from such alteration, modification, copying or reverse engineering.
6. Renesas Electronics products are classified according to the following two quality grades: "Standard" and "High Quality". The intended applications for each Renesas Electronics product depends on the product's quality grade, as indicated below.
 - "Standard": Computers; office equipment; communications equipment; test and measurement equipment; audio and visual equipment; home electronic appliances; machine tools; personal electronic equipment; industrial robots; etc.
 - "High Quality": Transportation equipment (automobiles, trains, ships, etc.); traffic control (traffic lights); large-scale communication equipment; key financial terminal systems; safety control equipment; etc.

Unless expressly designated as a high reliability product or a product for harsh environments in a Renesas Electronics data sheet or other Renesas Electronics document, Renesas Electronics products are not intended or authorized for use in products or systems that may pose a direct threat to human life or bodily injury (artificial life support devices or systems; surgical implantations; etc.), or may cause serious property damage (space system; undersea repeaters; nuclear power control systems; aircraft control systems; key plant systems; military equipment; etc.). Renesas Electronics disclaims any and all liability for any damages or losses incurred by you or any third parties arising from the use of any Renesas Electronics product that is inconsistent with any Renesas Electronics data sheet, user's manual or other Renesas Electronics document.
7. No semiconductor product is absolutely secure. Notwithstanding any security measures or features that may be implemented in Renesas Electronics hardware or software products, Renesas Electronics shall have absolutely no liability arising out of any vulnerability or security breach, including but not limited to any unauthorized access to or use of a Renesas Electronics product or a system that uses a Renesas Electronics product. RENESAS ELECTRONICS DOES NOT WARRANT OR GUARANTEE THAT RENESAS ELECTRONICS PRODUCTS, OR ANY SYSTEMS CREATED USING RENESAS ELECTRONICS PRODUCTS WILL BE INVULNERABLE OR FREE FROM CORRUPTION, ATTACK, VIRUSES, INTERFERENCE, HACKING, DATA LOSS OR THEFT, OR OTHER SECURITY INTRUSION ("Vulnerability Issues"). RENESAS ELECTRONICS DISCLAIMS ANY AND ALL RESPONSIBILITY OR LIABILITY ARISING FROM OR RELATED TO ANY VULNERABILITY ISSUES. FURTHERMORE, TO THE EXTENT PERMITTED BY APPLICABLE LAW, RENESAS ELECTRONICS DISCLAIMS ANY AND ALL WARRANTIES, EXPRESS OR IMPLIED, WITH RESPECT TO THIS DOCUMENT AND ANY RELATED OR ACCOMPANYING SOFTWARE OR HARDWARE, INCLUDING BUT NOT LIMITED TO THE IMPLIED WARRANTIES OF MERCHANTABILITY, OR FITNESS FOR A PARTICULAR PURPOSE.
8. When using Renesas Electronics products, refer to the latest product information (data sheets, user's manuals, application notes, "General Notes for Handling and Using Semiconductor Devices" in the reliability handbook, etc.), and ensure that usage conditions are within the ranges specified by Renesas Electronics with respect to maximum ratings, operating power supply voltage range, heat dissipation characteristics, installation, etc. Renesas Electronics disclaims any and all liability for any malfunctions, failure or accident arising out of the use of Renesas Electronics products outside of such specified ranges.
9. Although Renesas Electronics endeavors to improve the quality and reliability of Renesas Electronics products, semiconductor products have specific characteristics, such as the occurrence of failure at a certain rate and malfunctions under certain use conditions. Unless designated as a high reliability product or a product for harsh environments in a Renesas Electronics data sheet or other Renesas Electronics document, Renesas Electronics products are not subject to radiation resistance design. You are responsible for implementing safety measures to guard against the possibility of bodily injury, injury or damage caused by fire, and/or danger to the public in the event of a failure or malfunction of Renesas Electronics products, such as safety design for hardware and software, including but not limited to redundancy, fire control and malfunction prevention, appropriate treatment for aging degradation or any other appropriate measures. Because the evaluation of microcomputer software alone is very difficult and impractical, you are responsible for evaluating the safety of the final products or systems manufactured by you.
10. Please contact a Renesas Electronics sales office for details as to environmental matters such as the environmental compatibility of each Renesas Electronics product. You are responsible for carefully and sufficiently investigating applicable laws and regulations that regulate the inclusion or use of controlled substances, including without limitation, the EU RoHS Directive, and using Renesas Electronics products in compliance with all these applicable laws and regulations. Renesas Electronics disclaims any and all liability for damages or losses occurring as a result of your noncompliance with applicable laws and regulations.
11. Renesas Electronics products and technologies shall not be used for or incorporated into any products or systems whose manufacture, use, or sale is prohibited under any applicable domestic or foreign laws or regulations. You shall comply with any applicable export control laws and regulations promulgated and administered by the governments of any countries asserting jurisdiction over the parties or transactions.
12. It is the responsibility of the buyer or distributor of Renesas Electronics products, or any other party who distributes, disposes of, or otherwise sells or transfers the product to a third party, to notify such third party in advance of the contents and conditions set forth in this document.
13. This document shall not be reprinted, reproduced or duplicated in any form, in whole or in part, without prior written consent of Renesas Electronics.
14. Please contact a Renesas Electronics sales office if you have any questions regarding the information contained in this document or Renesas Electronics products.

(Note1) "Renesas Electronics" as used in this document means Renesas Electronics Corporation and also includes its directly or indirectly controlled subsidiaries.

(Note2) "Renesas Electronics product(s)" means any product developed or manufactured by or for Renesas Electronics.

(Rev.5.0-1 October 2020)

Corporate Headquarters

TOYOSU FORESIA, 3-2-24 Toyosu,
Koto-ku, Tokyo 135-0061, Japan
www.renesas.com

Trademarks

Renesas and the Renesas logo are trademarks of Renesas Electronics Corporation. All trademarks and registered trademarks are the property of their respective owners.

Contact information

For further information on a product, technology, the most up-to-date version of a document, or your nearest sales office, please visit:
www.renesas.com/contact/.