

To our customers,

Old Company Name in Catalogs and Other Documents

On April 1st, 2010, NEC Electronics Corporation merged with Renesas Technology Corporation, and Renesas Electronics Corporation took over all the business of both companies. Therefore, although the old company name remains in this document, it is a valid Renesas Electronics document. We appreciate your understanding.

Renesas Electronics website: <http://www.renesas.com>

April 1st, 2010
Renesas Electronics Corporation

Issued by: Renesas Electronics Corporation (<http://www.renesas.com>)

Send any inquiries to <http://www.renesas.com/inquiry>.

Notice

1. All information included in this document is current as of the date this document is issued. Such information, however, is subject to change without any prior notice. Before purchasing or using any Renesas Electronics products listed herein, please confirm the latest product information with a Renesas Electronics sales office. Also, please pay regular and careful attention to additional and different information to be disclosed by Renesas Electronics such as that disclosed through our website.
2. Renesas Electronics does not assume any liability for infringement of patents, copyrights, or other intellectual property rights of third parties by or arising from the use of Renesas Electronics products or technical information described in this document. No license, express, implied or otherwise, is granted hereby under any patents, copyrights or other intellectual property rights of Renesas Electronics or others.
3. You should not alter, modify, copy, or otherwise misappropriate any Renesas Electronics product, whether in whole or in part.
4. Descriptions of circuits, software and other related information in this document are provided only to illustrate the operation of semiconductor products and application examples. You are fully responsible for the incorporation of these circuits, software, and information in the design of your equipment. Renesas Electronics assumes no responsibility for any losses incurred by you or third parties arising from the use of these circuits, software, or information.
5. When exporting the products or technology described in this document, you should comply with the applicable export control laws and regulations and follow the procedures required by such laws and regulations. You should not use Renesas Electronics products or the technology described in this document for any purpose relating to military applications or use by the military, including but not limited to the development of weapons of mass destruction. Renesas Electronics products and technology may not be used for or incorporated into any products or systems whose manufacture, use, or sale is prohibited under any applicable domestic or foreign laws or regulations.
6. Renesas Electronics has used reasonable care in preparing the information included in this document, but Renesas Electronics does not warrant that such information is error free. Renesas Electronics assumes no liability whatsoever for any damages incurred by you resulting from errors in or omissions from the information included herein.
7. Renesas Electronics products are classified according to the following three quality grades: “Standard”, “High Quality”, and “Specific”. The recommended applications for each Renesas Electronics product depends on the product’s quality grade, as indicated below. You must check the quality grade of each Renesas Electronics product before using it in a particular application. You may not use any Renesas Electronics product for any application categorized as “Specific” without the prior written consent of Renesas Electronics. Further, you may not use any Renesas Electronics product for any application for which it is not intended without the prior written consent of Renesas Electronics. Renesas Electronics shall not be in any way liable for any damages or losses incurred by you or third parties arising from the use of any Renesas Electronics product for an application categorized as “Specific” or for which the product is not intended where you have failed to obtain the prior written consent of Renesas Electronics. The quality grade of each Renesas Electronics product is “Standard” unless otherwise expressly specified in a Renesas Electronics data sheets or data books, etc.
 - “Standard”: Computers; office equipment; communications equipment; test and measurement equipment; audio and visual equipment; home electronic appliances; machine tools; personal electronic equipment; and industrial robots.
 - “High Quality”: Transportation equipment (automobiles, trains, ships, etc.); traffic control systems; anti-disaster systems; anti-crime systems; safety equipment; and medical equipment not specifically designed for life support.
 - “Specific”: Aircraft; aerospace equipment; submersible repeaters; nuclear reactor control systems; medical equipment or systems for life support (e.g. artificial life support devices or systems), surgical implantations, or healthcare intervention (e.g. excision, etc.), and any other applications or purposes that pose a direct threat to human life.
8. You should use the Renesas Electronics products described in this document within the range specified by Renesas Electronics, especially with respect to the maximum rating, operating supply voltage range, movement power voltage range, heat radiation characteristics, installation and other product characteristics. Renesas Electronics shall have no liability for malfunctions or damages arising out of the use of Renesas Electronics products beyond such specified ranges.
9. Although Renesas Electronics endeavors to improve the quality and reliability of its products, semiconductor products have specific characteristics such as the occurrence of failure at a certain rate and malfunctions under certain use conditions. Further, Renesas Electronics products are not subject to radiation resistance design. Please be sure to implement safety measures to guard them against the possibility of physical injury, and injury or damage caused by fire in the event of the failure of a Renesas Electronics product, such as safety design for hardware and software including but not limited to redundancy, fire control and malfunction prevention, appropriate treatment for aging degradation or any other appropriate measures. Because the evaluation of microcomputer software alone is very difficult, please evaluate the safety of the final products or system manufactured by you.
10. Please contact a Renesas Electronics sales office for details as to environmental matters such as the environmental compatibility of each Renesas Electronics product. Please use Renesas Electronics products in compliance with all applicable laws and regulations that regulate the inclusion or use of controlled substances, including without limitation, the EU RoHS Directive. Renesas Electronics assumes no liability for damages or losses occurring as a result of your noncompliance with applicable laws and regulations.
11. This document may not be reproduced or duplicated, in any form, in whole or in part, without prior written consent of Renesas Electronics.
12. Please contact a Renesas Electronics sales office if you have any questions regarding the information contained in this document or Renesas Electronics products, or if you have any other inquiries.

(Note 1) “Renesas Electronics” as used in this document means Renesas Electronics Corporation and also includes its majority-owned subsidiaries.

(Note 2) “Renesas Electronics product(s)” means any product developed or manufactured by or for Renesas Electronics.

M16C/28, 29 Group

Remote Control Reception

1. Abstract

This documents describes how to receive a remote control signal using the time measurement function of timer S.

2. Introduction

The application example described in this document is applied to the following MCU and parameter(s):
 MCU: M16C/28, 29 Group

This program can be used with other M16C Family MCUs which have the same special function registers (SFRs) as the M16C/28 and M16C/29 Groups. Check the manual for any additions and modifications to functions. Careful evaluation is recommended before using this application note.

3. Remote Control Reception Overview

An infrared signal transmitted from the remote control is transmitted to the receiver at a certain frequency (carrier frequency). As the infrared signal is weakened through diffusion at the receiver, the output of the infrared receiving element must be amplified using a preamplifier. Also, passing through a bandpass filter (BPF) allows an accurate remote control signal to be obtained by extracting only the carrier waveform element and detecting and rectifying the waveform. In this case, the carrier frequency is set to 38 kHz.

Figure 3.1 shows the Block Diagram of Remote Control Reception Overview, Figure 3.2 shows the Internal Block Diagram of Infrared Remote Control Receive Module, and Figure 3.3 shows the Carrier Waveform.

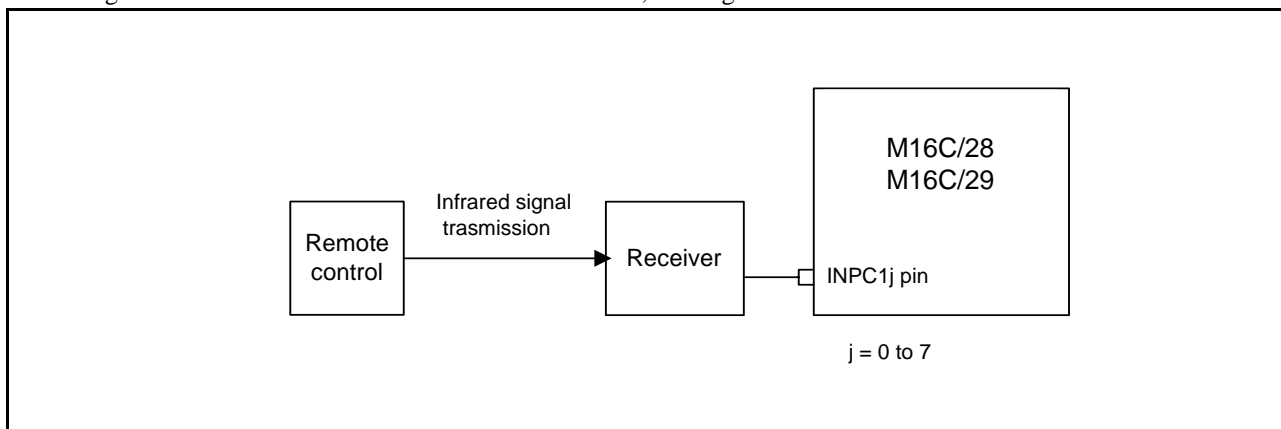

Figure 3.1 Block Diagram of Remote Control Reception Overview

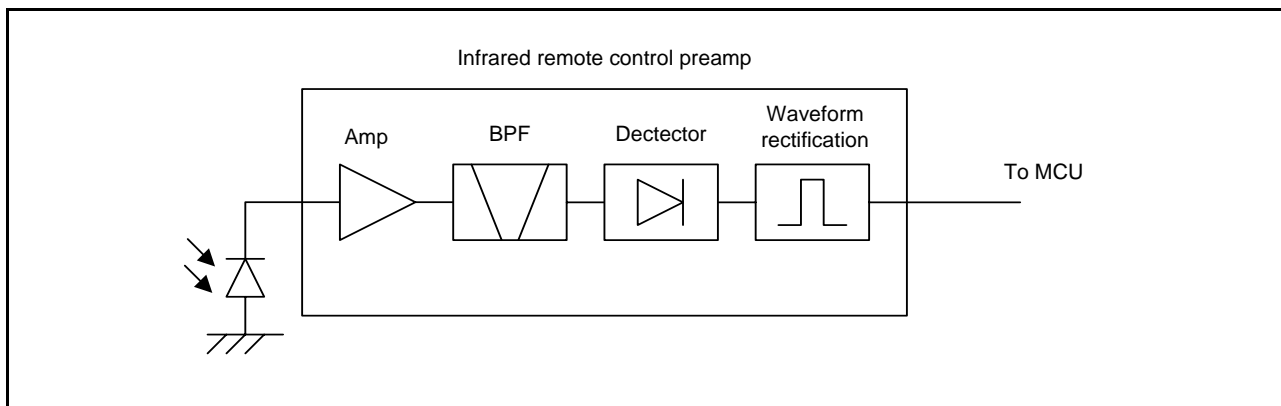

Figure 3.2 Internal Block Diagram of Infrared Remote Control Receive Module

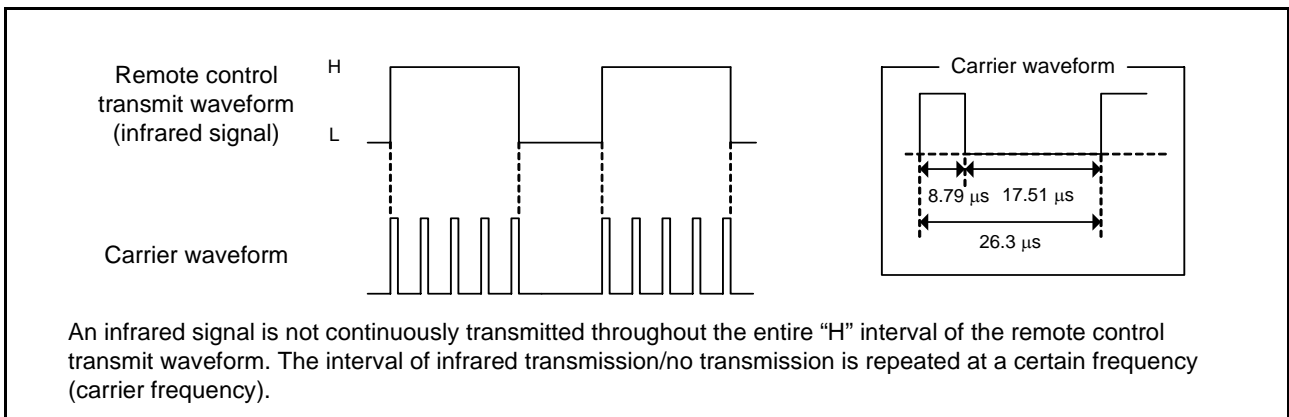

Figure 3.3 Carrier Waveform

4. Time Measurement Function

The time measurement function of timer S synchronizes with the external trigger input and stores the base timer value to the G1TMj register (j = 0 to 7). Figure 4.1 shows the Operational Timing of Time Measurement Function.

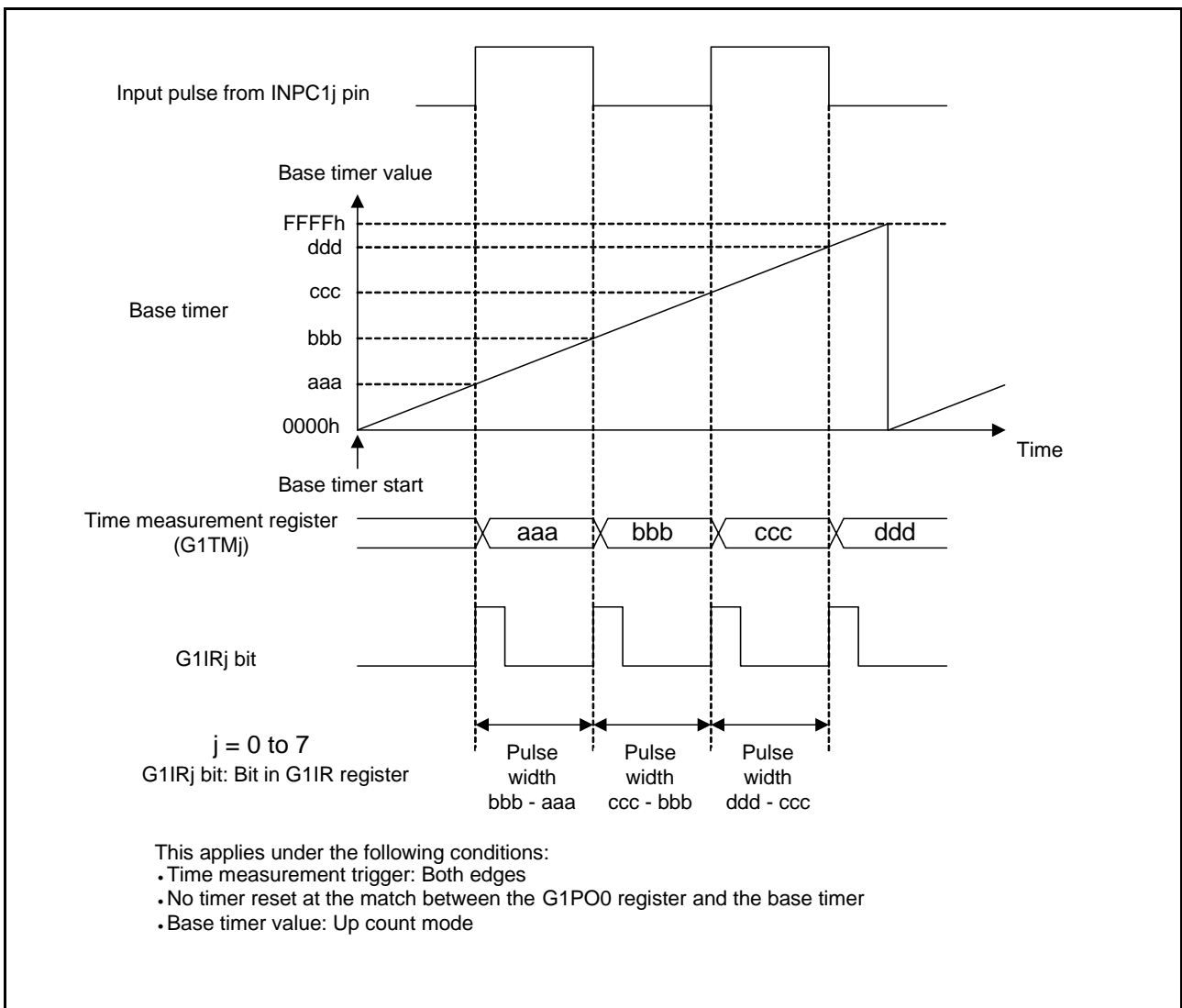

Figure 4.1 Operational Timing of Time Measurement Function

5. Operational Description

In this sample program, the count source f1 is set to 20 MHz and the count source division is set to divide-by-40 for timer S.

Waveform data can be measured using either positive or negative logic.

Table 5.1 lists the Resource List

Table 5.1 Resource List

Resource	Channel	Period	Application
Timer S	Time measurement 0 channel	2 μ s	Remote control transmit waveform time measurement
Timer A	Timer A0	1 ms	One frame timer measurement (for timer A1 event count)
	Time A1	140 ms	One frame timer measurement

5.1

- Timer S -

1. Set the base timer to divide-by-40 and the count source f1.
2. Set the timer measurement trigger for the base timer to both edges.
3. Setting the base timer start bit to 1 increments the base timer value.
4. Timer S time measurement function 0 interrupt request bit is set to 1 at the rising or falling edge of the INPC10 pin. At the same time, the base timer value (G1TM0) is stored.
5. The stored base timer value is converted to a pulse value and compared with the remote control data.

5.2

- Timer A -

1. Use timer A to measure one frame from the leader code.
2. Set timer A0 to timer mode and timer A1 to event counter mode (timer A0 underflow counted).
3. Set the timer A0 register (TA0) to (4E1F)h in order to set the timer A0 period to a 1 ms interval.
4. Set the timer A1 register (TA1) to (008B)h in order to set the timer A1 period to a 140 ms interval (one frame \pm 30% error).
5. Set the timer A0 and timer A1 count start flags to 1 upon detecting the rising or falling edge of the INPC10 pin and start the timer.
6. Stop timer A0 and timer A1 at the timer A1 underflow. If the stop bit is not received at this time, the frame is invalid.

6. Remote Control Detection Performance

- For the first data, reception is determined as complete if the following are received within 108 ms: the leader code, custom code (8 bits), inverted custom code (8 bits), data code (8 bits), inverted data code (8 bits), stop bit (1 bit), and one frame (interval including from the leader code to the frame space) of the frame space (interval of no infrared transmission).
- For the second or subsequent data, reception is determined as complete if the following are received within 108 ms: the leader code, stop bit (1 bit), and one frame of the frame space.
- For each code, code recognition is determined as complete if the error is within $\pm 30\%$ of the format value. The same applies to one frame if the error is within 108 ms $\pm 30\%$.
- When the leader code is detected, detection takes place in the order of custom code, data code, stop bit, and frame space.
- If a receive error occurs on each code, the next rising or falling edge is determined as the leader code (first data) and reception starts.
- When one frame (including the $\pm 30\%$ error) or more has elapsed after the leader code, if the frame space is being recognized in the received data, reception is determined as complete.
- When the leader code after the frame space is detected within one frame (including the $\pm 30\%$ error), the detected received data is recognized as the second or subsequent data. (The first leader code may be received within one frame after the frame space as the $\pm 30\%$ error is included.)
- Figure 6.1 shows the Remote Control Format Diagram.

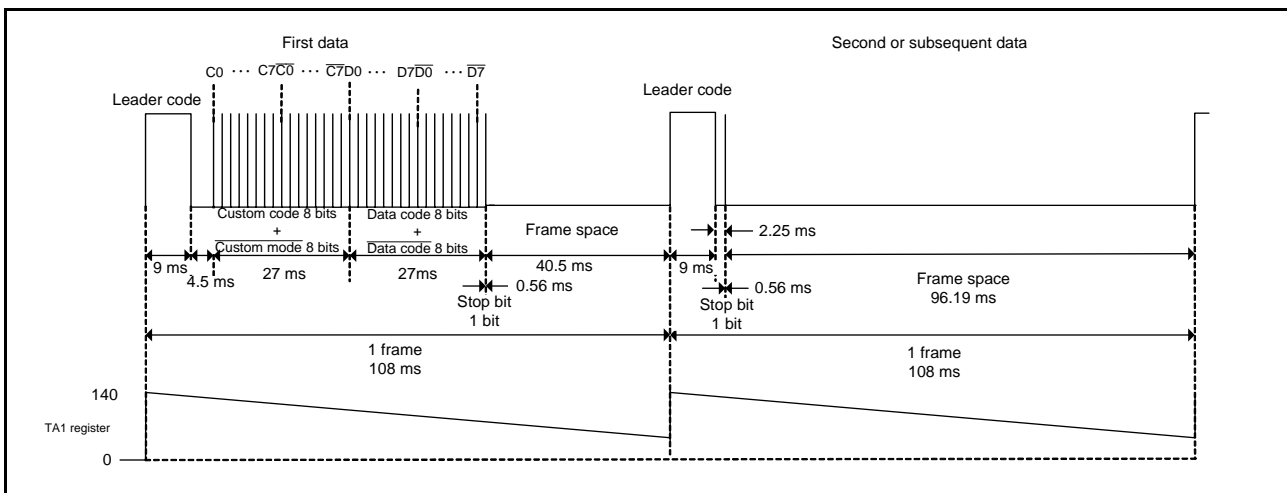

Figure 6.1 Remote Control Format Diagram

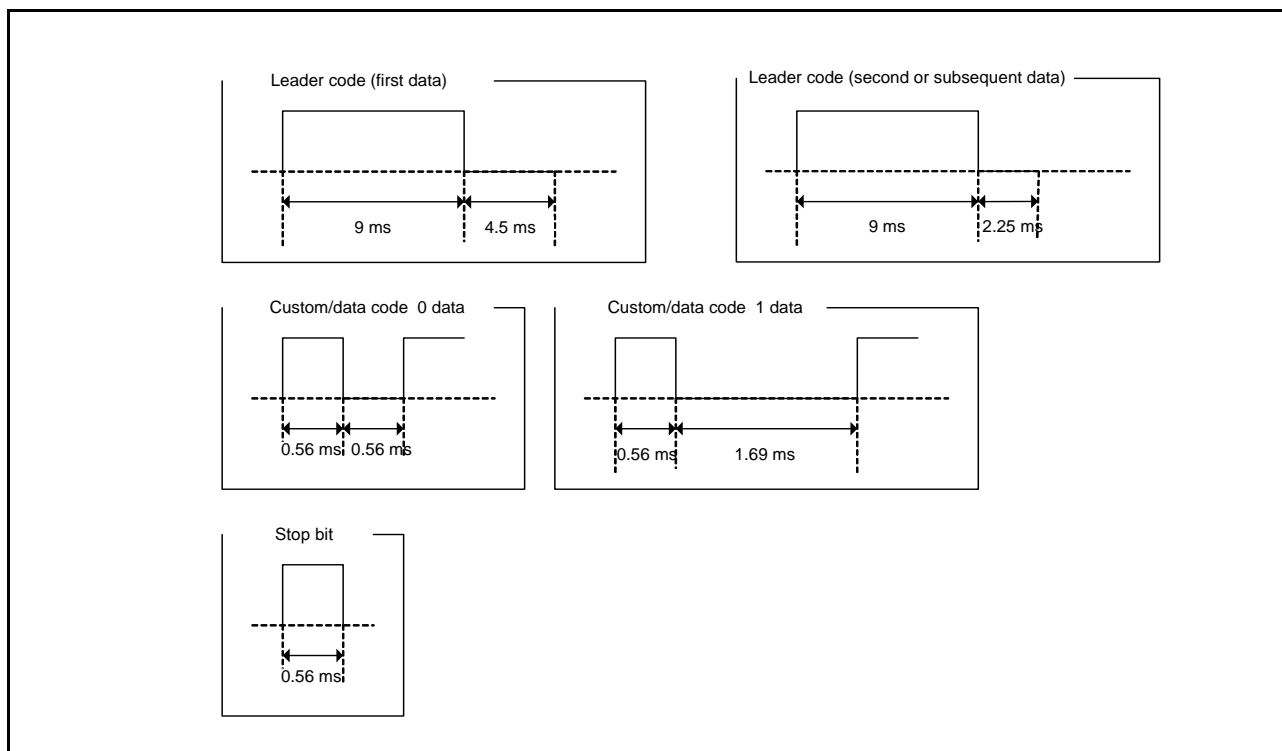

Figure 6.2 Expanded Codes

Table 6.1 Recognition Range Value by Code

Code Name	Code Recognition Range Value
Leader code "H"	6.30 ms to 11.70 ms
Leader code "L"	3.15 ms to 5.85 ms
Custom code "H"	0.39 ms to 0.73 ms
Custom code (0 data) "L"	0.39 ms to 0.73 ms
Custom code (1 data) "L"	1.18 ms to 2.20 ms
Data code "H"	0.39 ms to 0.73 ms
Data code (0 data) "L"	0.39 ms to 0.73 ms
Data code (1 data) "L"	1.18 ms to 2.20 ms
Stop bit	0.39 ms to 0.73 ms
Frame space	28.35 ms to 52.65 ms
Leader code "H" (repeat)	6.30 ms to 11.70 ms
Leader code "L" (repeat)	1.58 ms to 2.92 ms
Stop bit (repeat)	0.39 ms to 0.73 ms
Frame space (repeat)	67.33 ms to 125.05 ms

7. Software Description

7.1 Function Description

Table 7.1 lists the Function Description.

Table 7.1 Function Description

Function Name	Label Name	Feature
Main processing	main	Used register setting, used RAM initialization, interrupt enable, received data decision, timer decision
Received data setting processing	rcv_data	Received data setting process upon received data interrupt detection
Time over setting processing	time_over	Setup processing after one-frame time elapsed upon leader code detection
Pulse value setting processing	set_pulse_value	Pulse value setting
Received data decision processing	check_code	Received data decision/setting
Received data range check processing	cop_pulse	Received data range decision
Inverted data code decision processing	judge_reversing_code	Inverted data code decision
Inverted data code buffer setting processing	set_reversubg_code	Inverted data code buffer setting
Inverted data code comparison processing	cop_reversing_code	Inverted data code comparison

7.2 Register Description

Table 7.2 lists the Register Description.

Table 7.2 Register Description

Register Name		Address	Setting Value	Feature
G1BCR0	Base timer control register 0	0322h	00h 03h	<ul style="list-style-type: none"> • Clock stop • Bit 15 overflow, f1
G1DV	Count source divide register	032Ah	27h	<ul style="list-style-type: none"> • Divide-by-40
G1BCR1	Base timer control register 1	0323h	00h 10h	<ul style="list-style-type: none"> • Up count mode • Base timer reset/count start • No base timer reset at the "L" level input to the INT1 pin • No base timer reset at the match between the G1PO0 register and the base timer
G1TMCR0	Time measurement control register 0	0318h	03h	<ul style="list-style-type: none"> • No digital filter • The time measurement trigger is selected as both edges.
G1FS	Function select register	0327h	01h	Time measurement function for channel 0
G1FE	Function enable register	0326h	01h	Functional operation for channel 0
G1TM0	Time measurement register 0	0300h	-	A base timer value is stored at every time measurement timing.
G1IR	Interrupt request register	0330h	00h	Timer S Channel 0 interrupt request clear
TABSR	Count start flag	0380h	00h 03h	Timer A0, A1 count stop/start
TA0MR	Timer A0 mode register	0396h	00h	<ul style="list-style-type: none"> • Count source f1 • No gate function • Timer mode
TA0	Timer A0 register	0386h	4E1Fh	Set to 1 ms.
TA1MR	Timer A1 mode register	0397h	01h	<ul style="list-style-type: none"> • Reload type • Event counter mode
TA1	Timer A1 register	0388h	008Bh	Set to 140 ms (108 ms +30%).
TRGSR	Trigger select register	0383h	02h	The timer A1 event trigger selected as the timer TA0 underflow.
TA0IC	Interrupt control register	0055h	00h	Priority level 0
TA1IC	Interrupt control register	0056h	00h	Priority level 0

7.3 RAM Description

Table 7.3 lists the RAM Description.

Table 7.3 RAM Description

RAM Name	Feature	Data Length	Function Used
rcv_mode	Receive mode	1 byte	main, rcv_data, time_over, check_code
rcv_bit_cnt	Number of received custom/data code bit	1 byte	main, rcv_data, check_code
rcv_data_cnt	Number of received data	1 byte	main, rcv_data, time_over, check_code
pulse[100]	Received data buffer Storage in hexadecimal	200 bytes	time_over, set_pulse_value, check_code
pulse_cnt	Received data buffer position	1 byte	main, rcv_data, time_over, set_pulse_value, check_code
code_low_cnt	Received data code "L" counter	1 byte	main, rcv_data, judge_reversing_code,
rev_cnt	Inverted data counter	1 byte	main, rcv_data, judge_reversing_code, set_reversing_code, cmp_reversing_code
rev_pulse[8]	Inverted data code confirmation buffer If the code is not inverted data, it is stored to the following: If 0 data: 0xF1 If 1 data: 0xF0	8 bytes	set_reversing_code, cmp_reversing_code
old_tr	Timer measurement capture value for next comparison	2 bytes	set_pulse_value

7.4 ROM Description

Table 7.4 lists the ROM Description.

Table 7.4 ROM Description

ROM Name	Feature	Data Length	Function Used
cmp_tbl[14][2]	<p>Received code compare table</p> <ul style="list-style-type: none"> • [*][0]: Format value for each interval, [*][1]: Format value $\pm 30\%$ • [*][0]-[*][1] to [*][0]+[*][1]: Code recognition range value • If an error has $\pm 30\%$ of a format value, recognition is OK. <p>[0][*]: Leader code "H" interval (6.30 ms to 11.70 ms) [1][*]: Leader code "L" interval (3.15 ms to 5.85 ms) [2][*]: Custom code "H" interval (0.39 ms to 0.73 ms) [3][*]: Custom code (0 data) "L" interval (0.39 ms to 0.73 ms) [4][*]: Custom code (1 data) "L" interval (1.18 ms to 2.20 ms) [5][*]: Data code "H" interval (0.39 ms to 0.73 ms) [6][*]: Data code (0 data) "L" interval (0.39 ms to 0.73 ms) [7][*]: Data code (1 data) "L" interval (1.18 ms to 2.20 ms) [8][*]: Stop bit interval (0.39 ms to 0.73 ms) [9][*]: Frame space interval (28.35 ms to 52.65 ms) [10][*]: Leader code "H" interval (repeat) (6.30 ms to 11.70 ms) [11][*]: Leader code "L" interval (repeat) (1.58 ms to 2.92 ms) [12][*]: Stop bit interval (repeat) (0.39 ms to 0.74 ms) [13][*]: Frame space interval (repeat) (67.33 ms to 125.05 ms)</p>	56 bytes	check_code

8. Setup Procedure

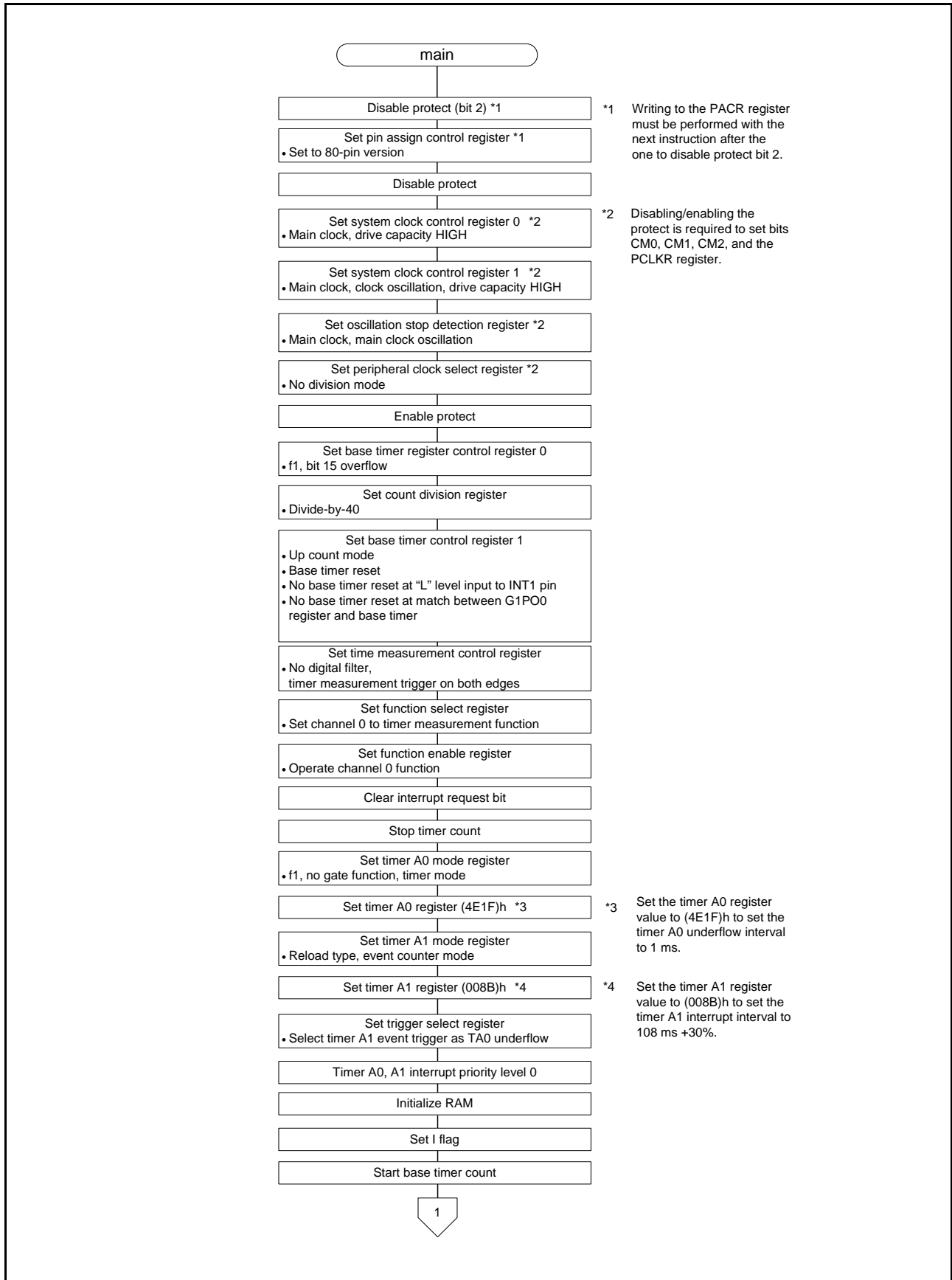

Figure 8.1 Flowchart (main)

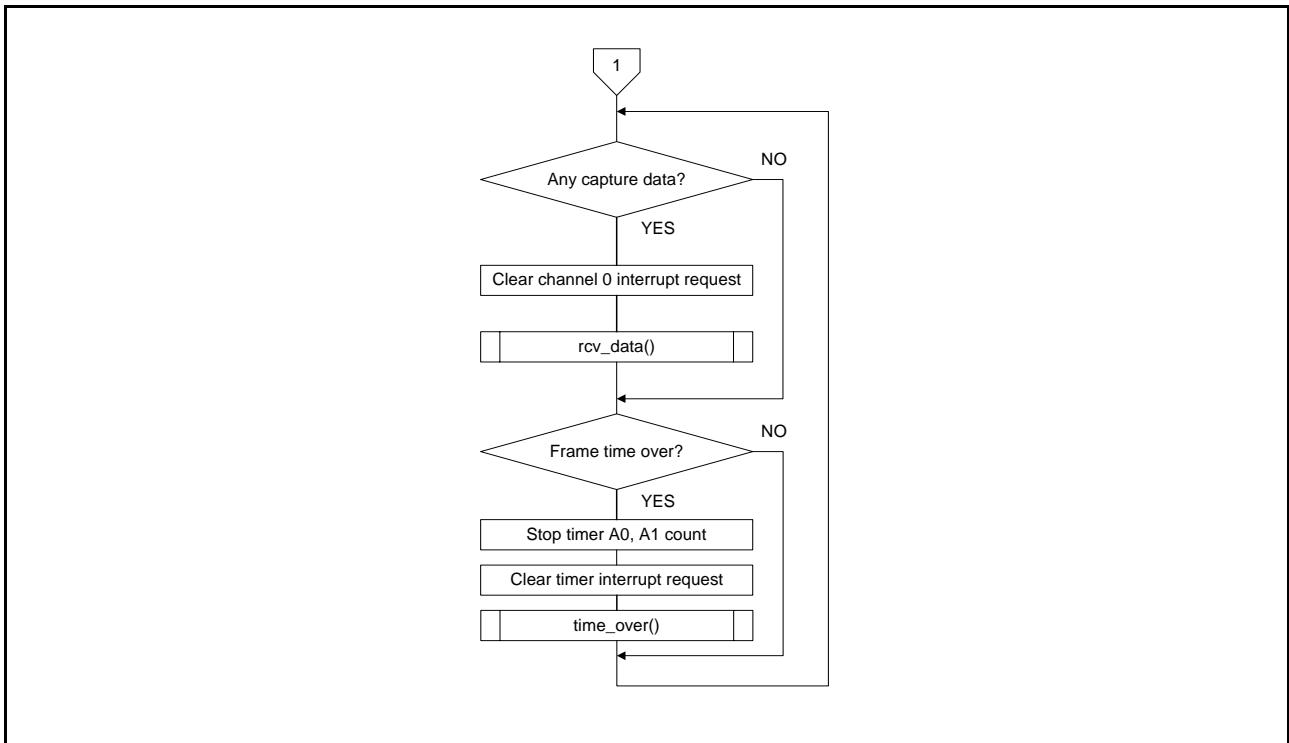

Figure 8.2 Flowchart (main)

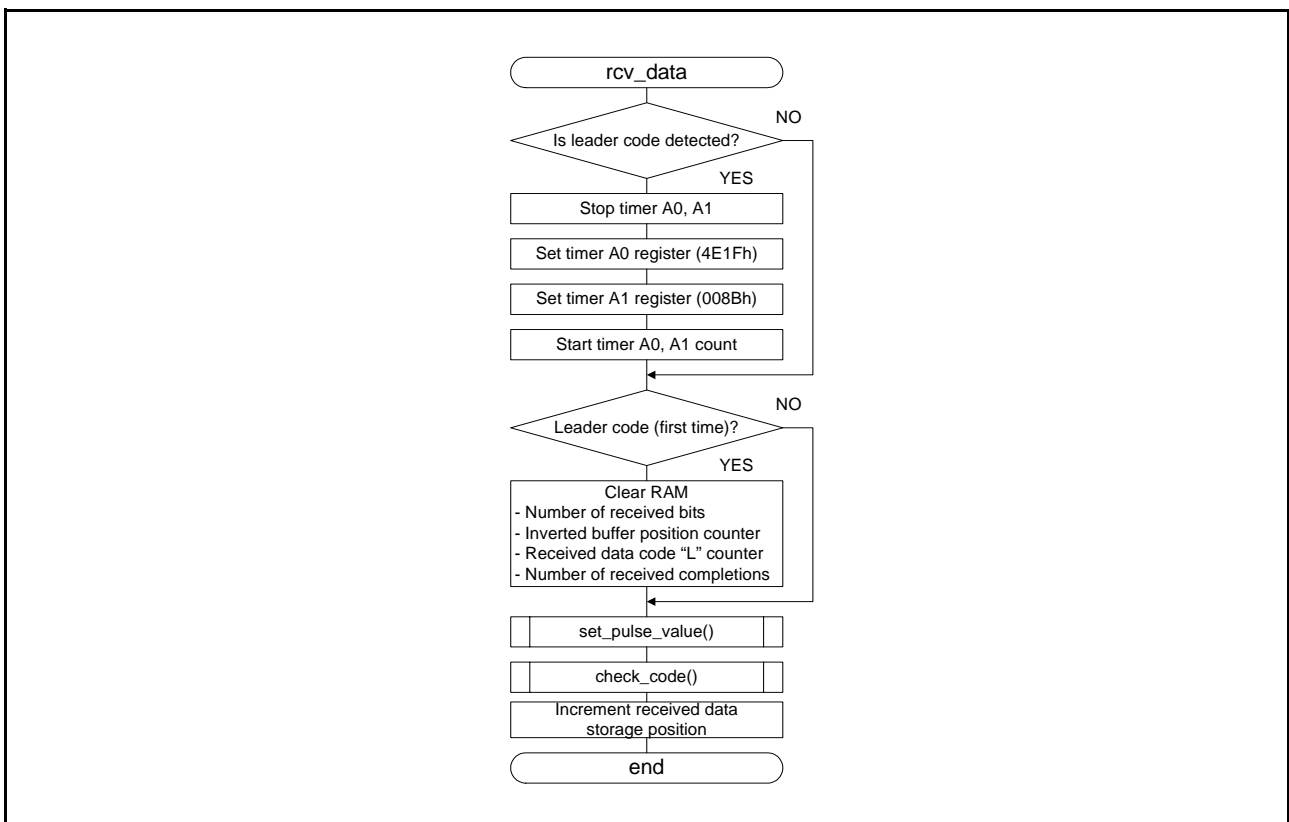

Figure 8.3 Flowchart (rcv_data)

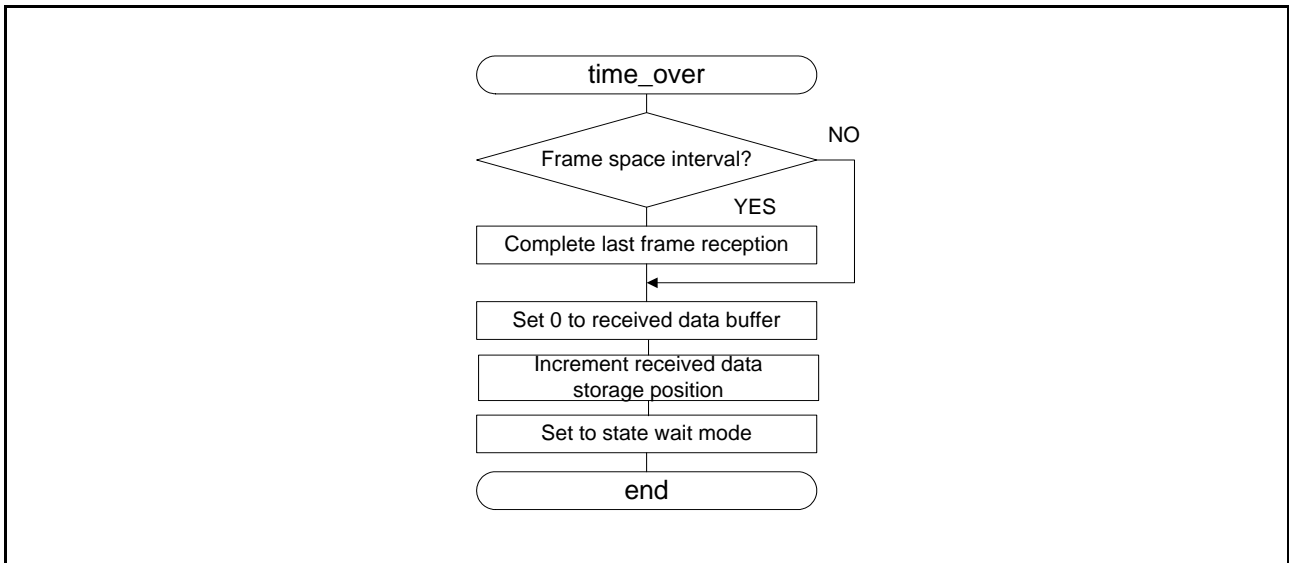

Figure 8.4 Flowchart (time_over)

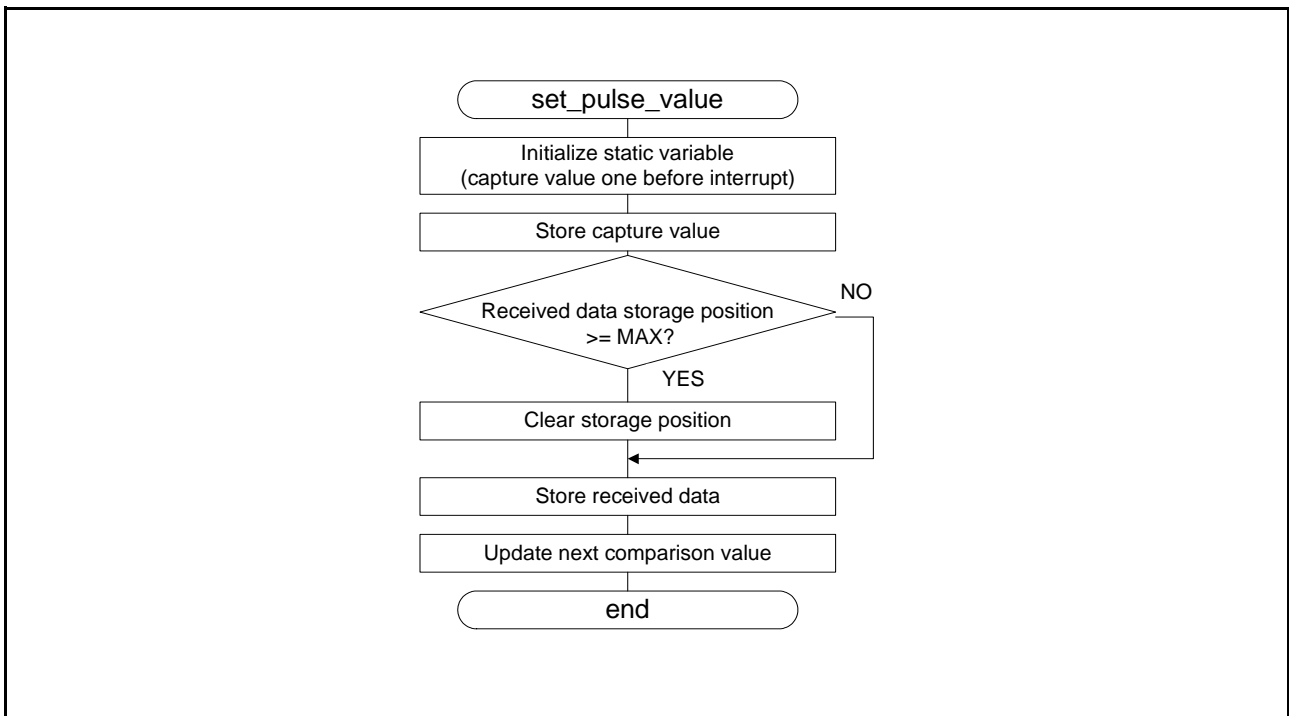

Figure 8.5 Flowchart (set_pulse_value)

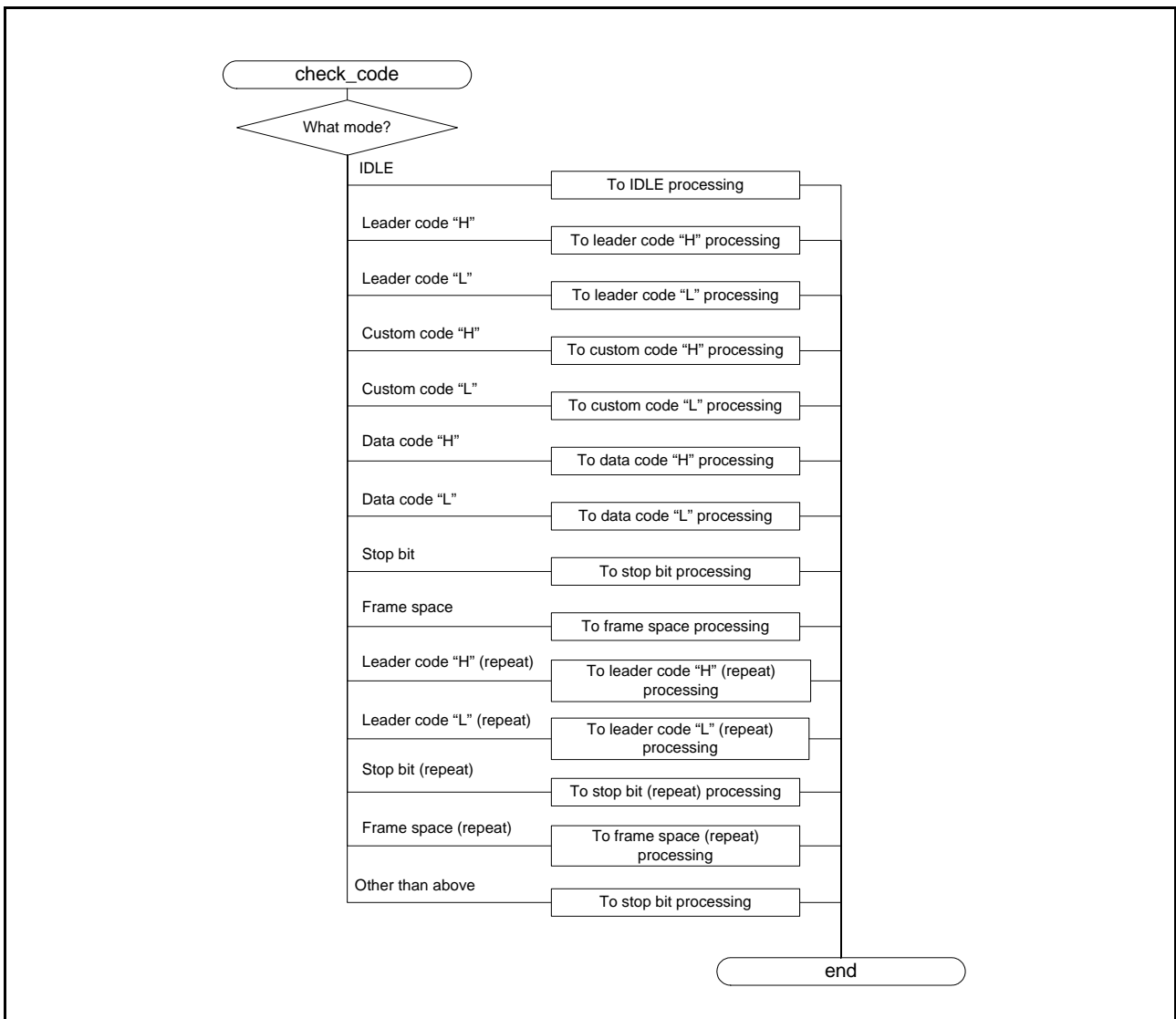

Figure 8.6 Flowchart (check_code)

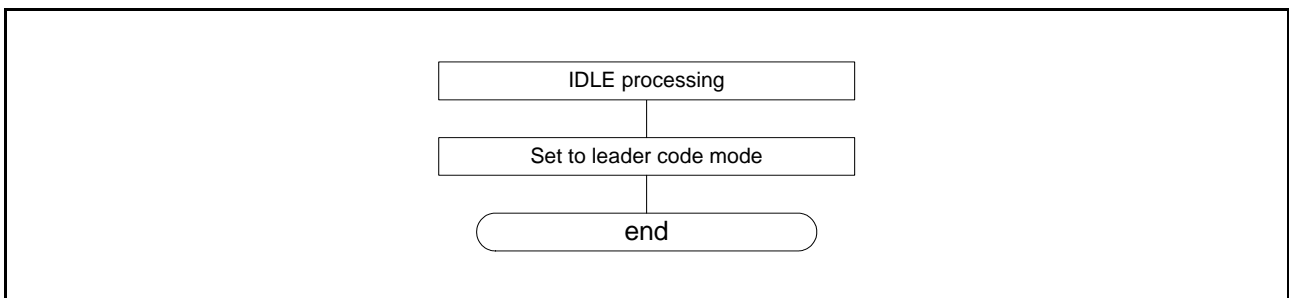

Figure 8.7 Flowchart (check_code/IDLE)

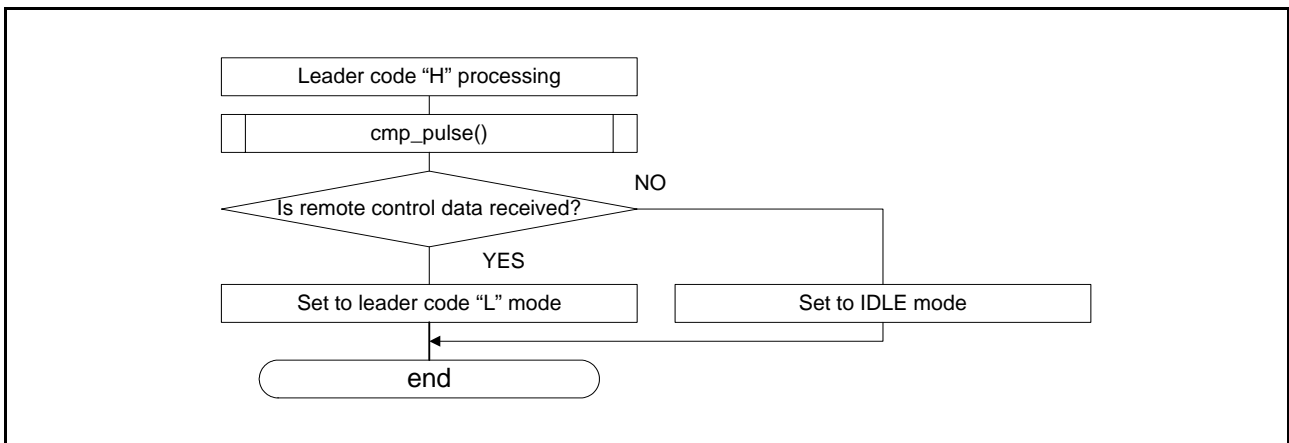

Figure 8.8 Flowchart (check_code/leader code "H")

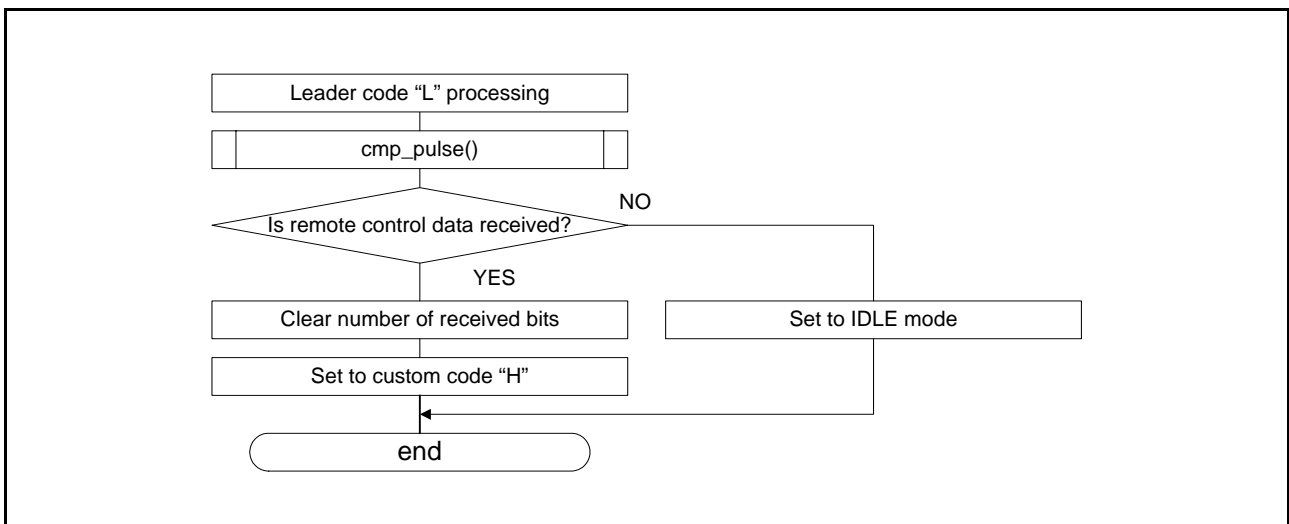

Figure 8.9 Flowchart (check_code/leader code "L")

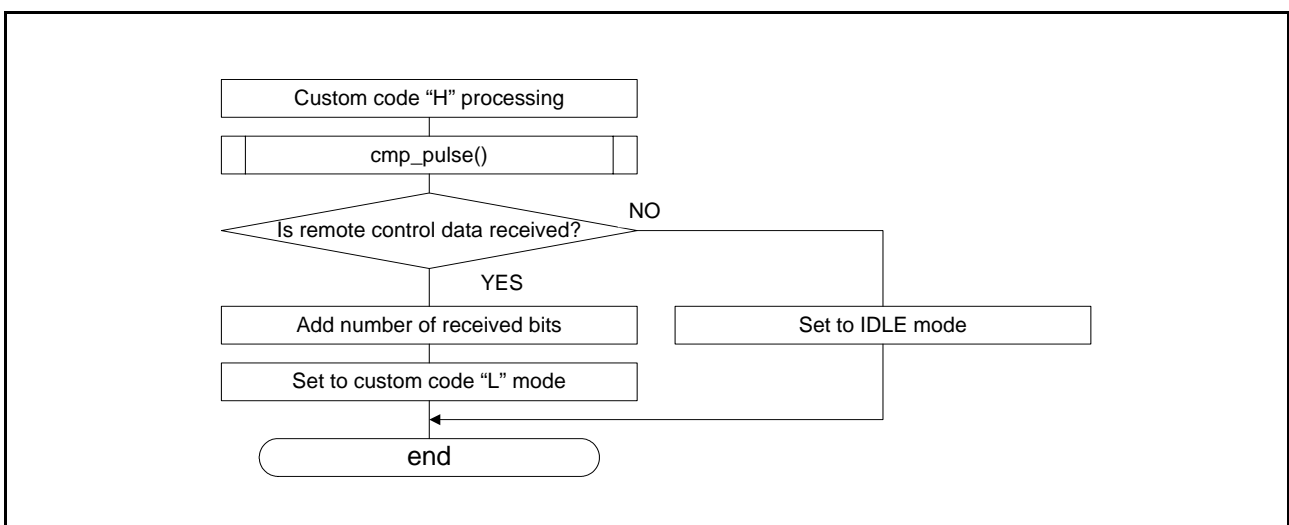

Figure 8.10 Flowchart (check_code/custom code "H")

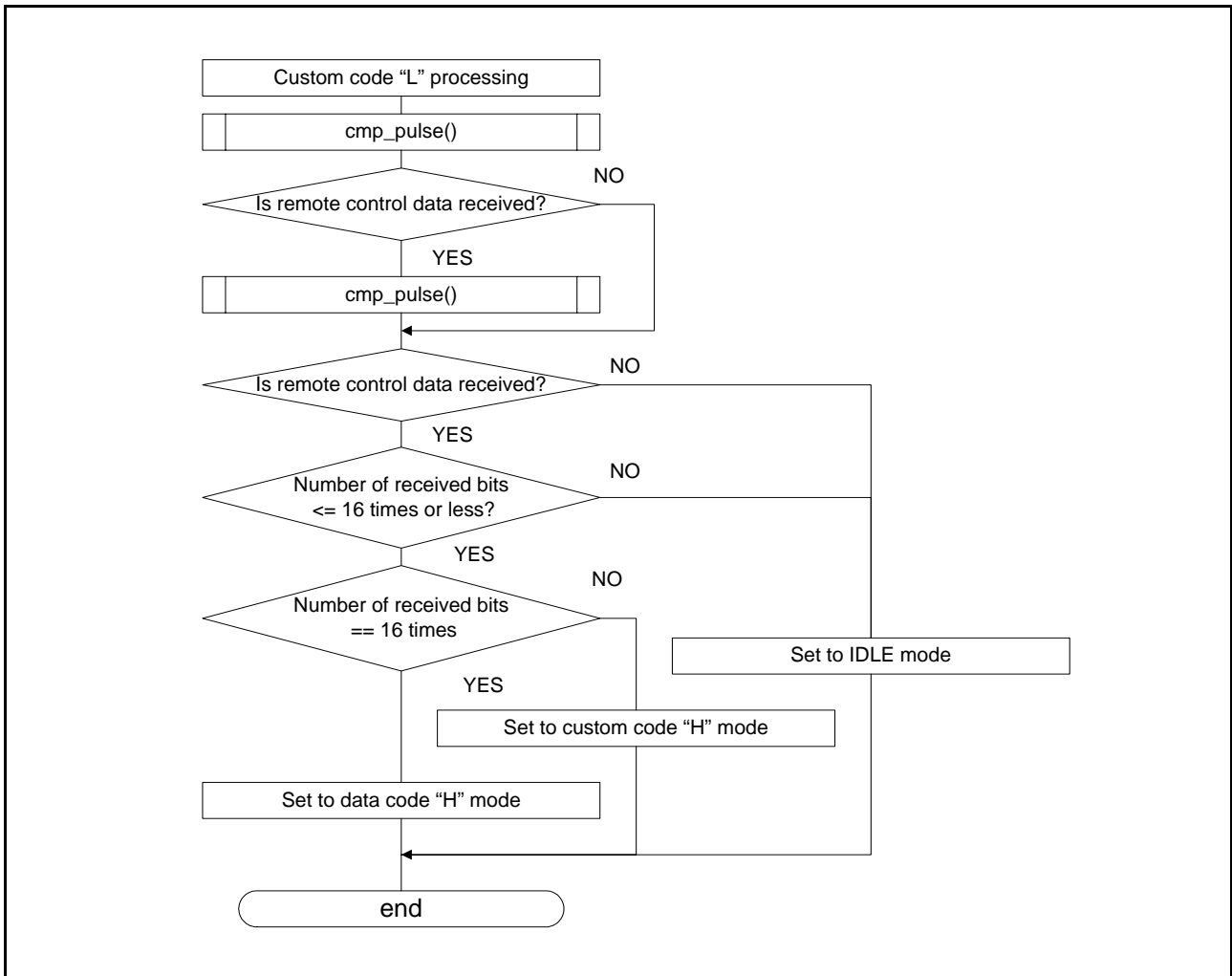

Figure 8.11 Flowchart (check_code/custom code "L")

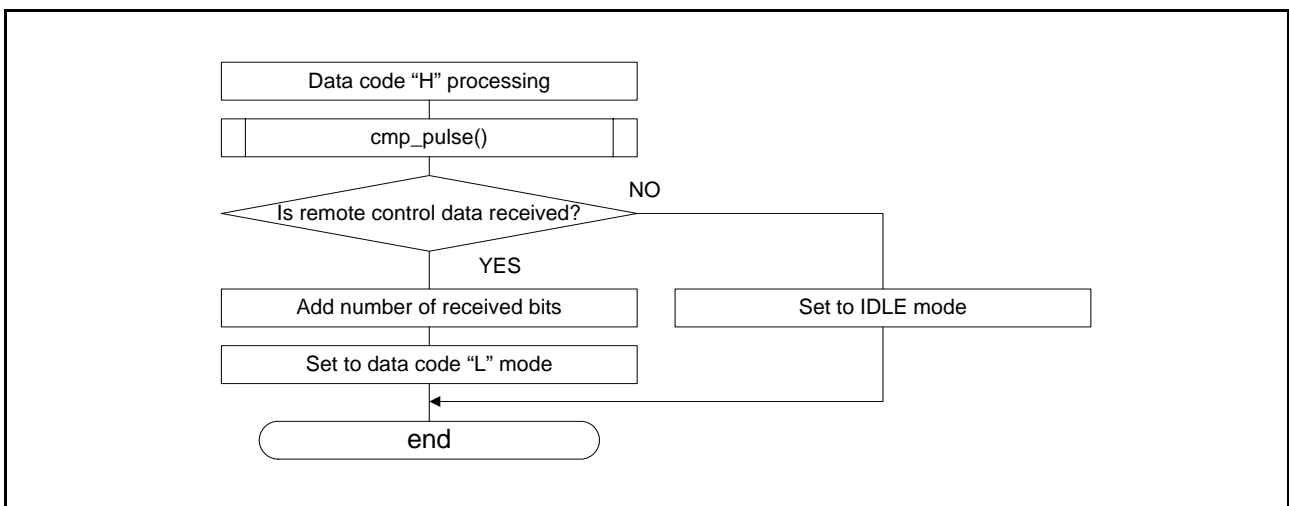

Figure 8.12 Flowchart (check_code/data code "H")

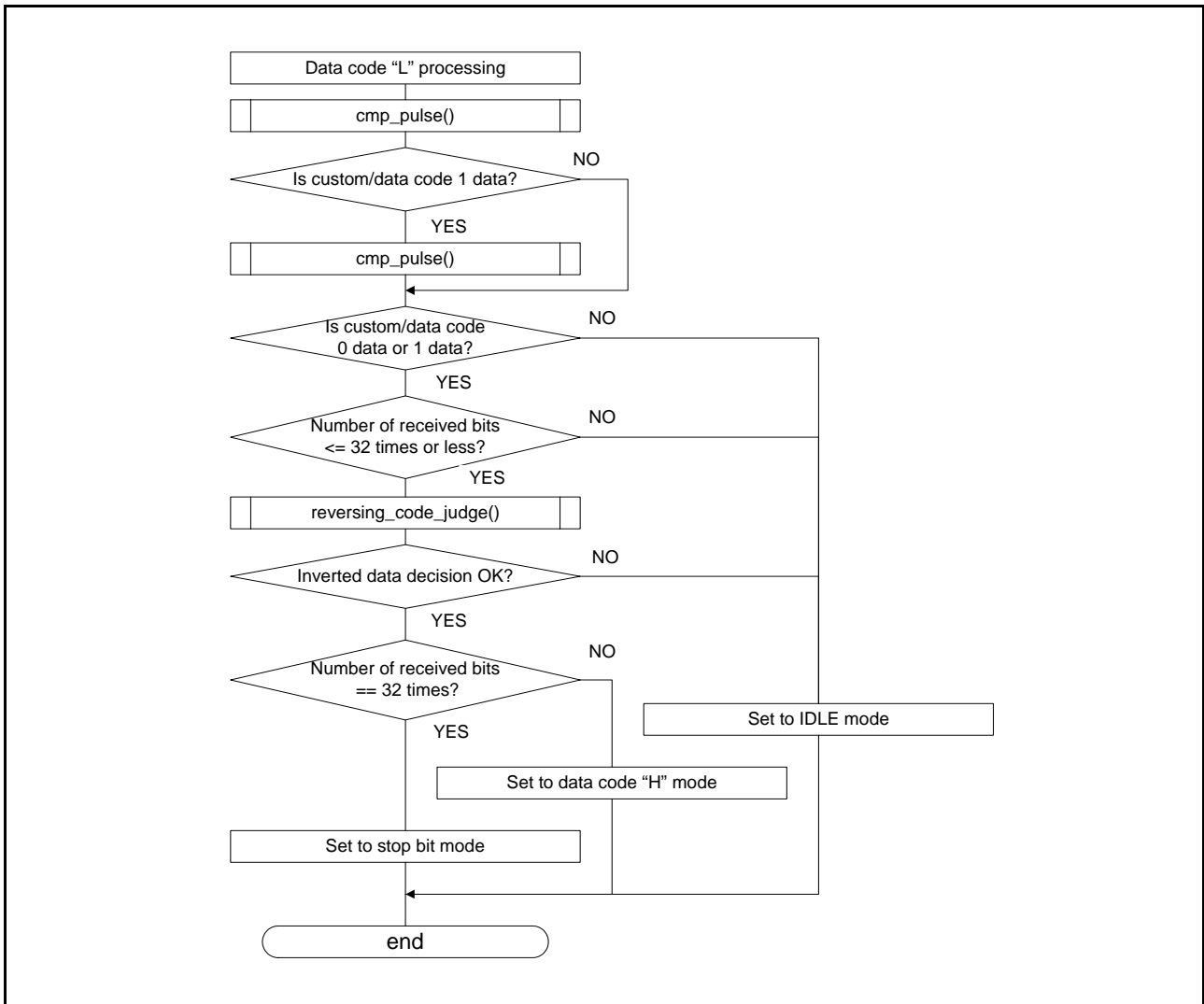

Figure 8.13 Flowchart (check_code/data code "L")

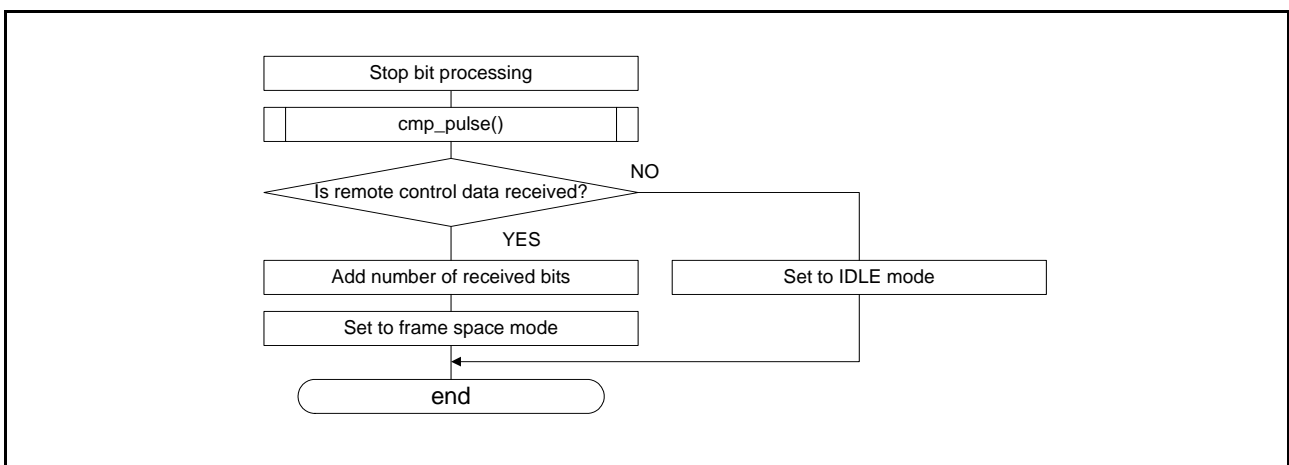

Figure 8.14 Flowchart (check_code/stop bit)

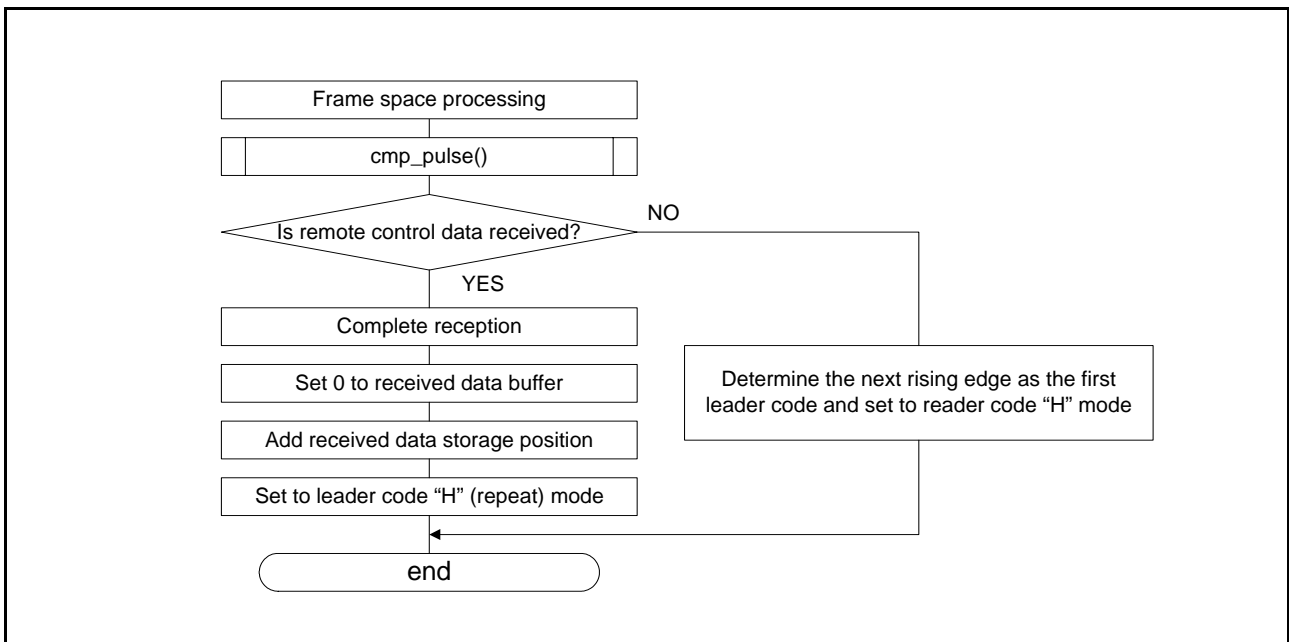

Figure 8.15 Flowchart (check_code/frame space)

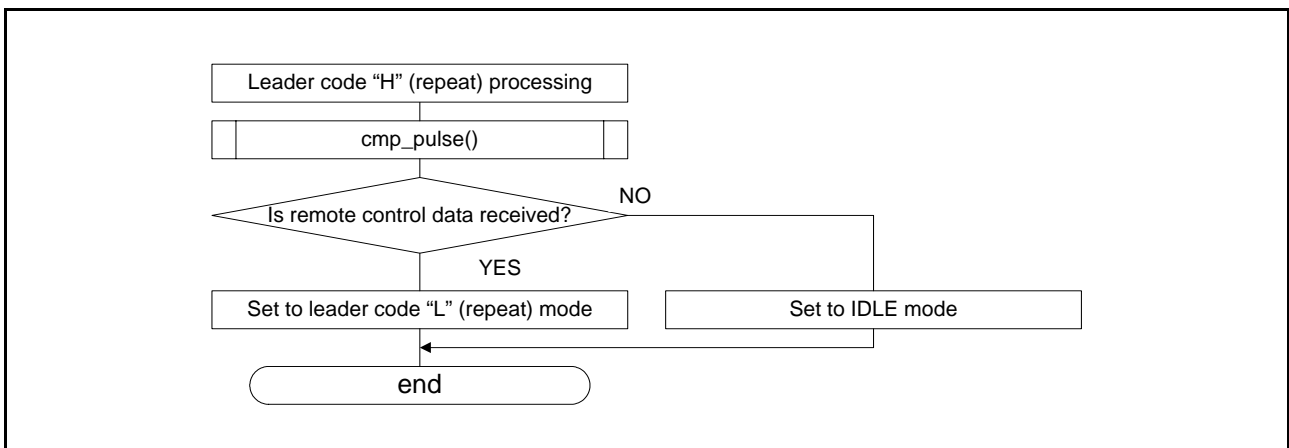

Figure 8.16 Flowchart (check_code/leader code "H" (repeat))

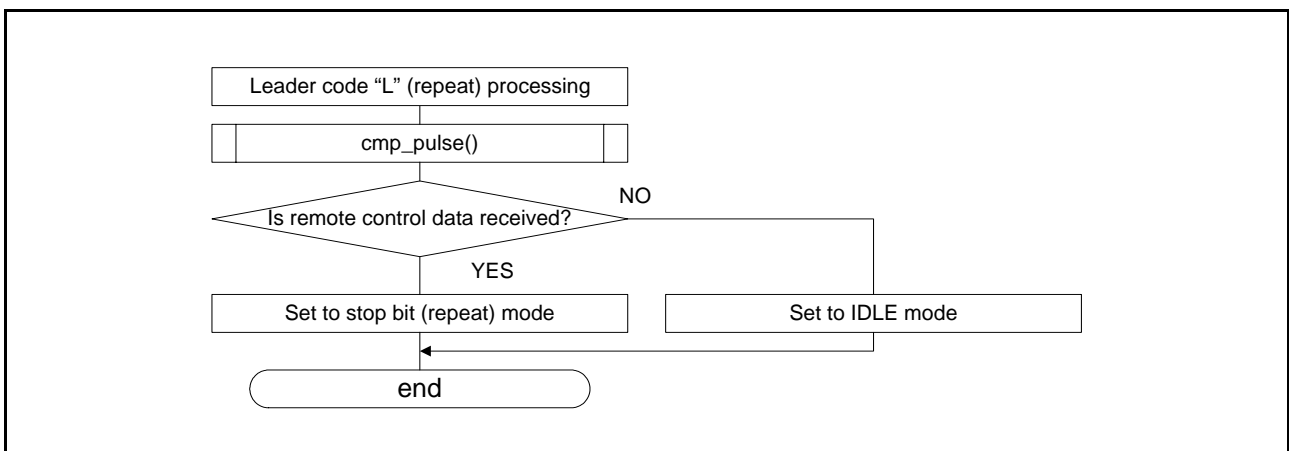

Figure 8.17 Flowchart (check_code/leader code "L" (repeat))

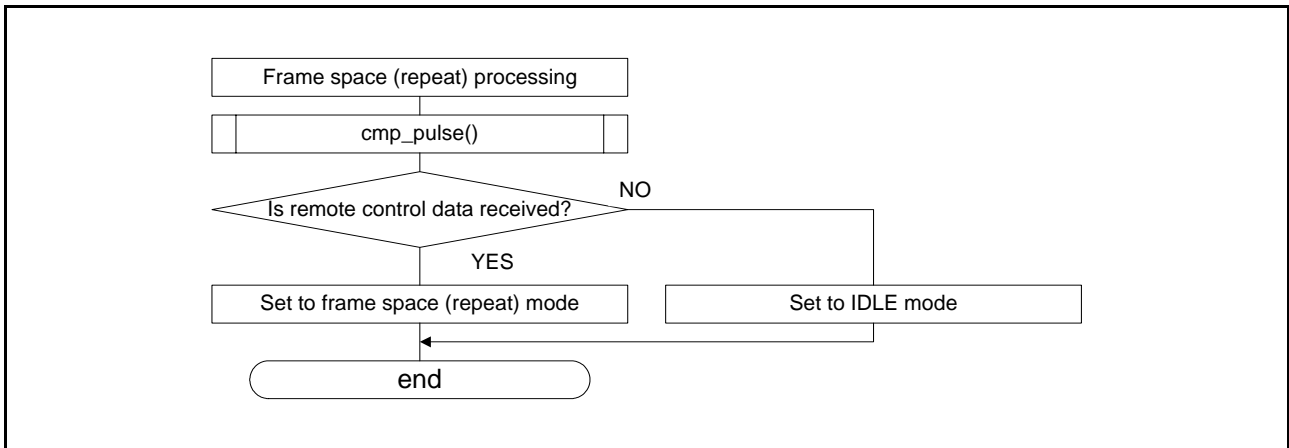

Figure 8.18 Flowchart (check_code/stop bit (repeat))

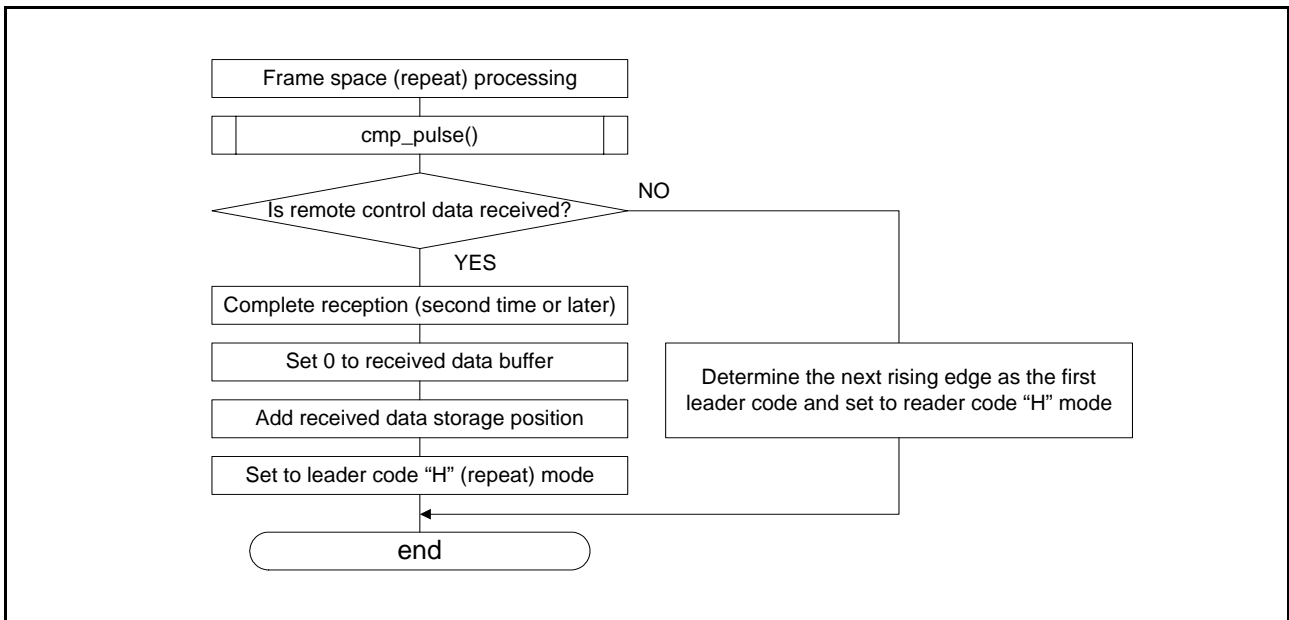

Figure 8.19 Flowchart (check_code/frame space (repeat))

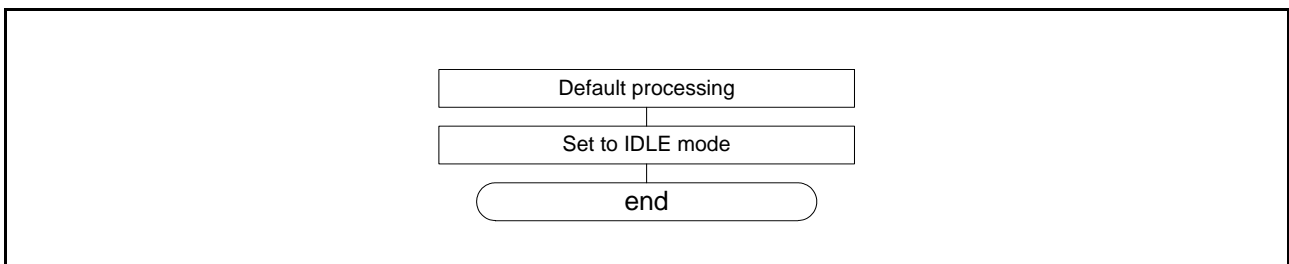

Figure 8.20 Flowchart (check_code/default)

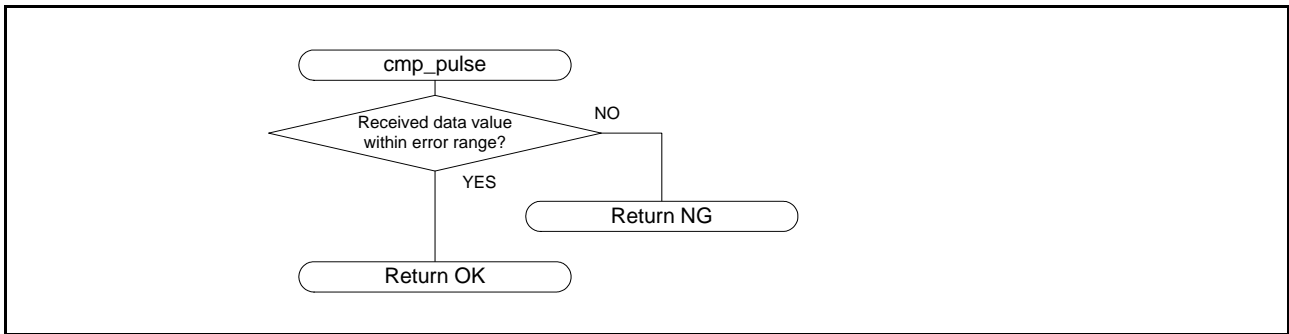

Figure 8.21 Flowchart (cmp_pulse)

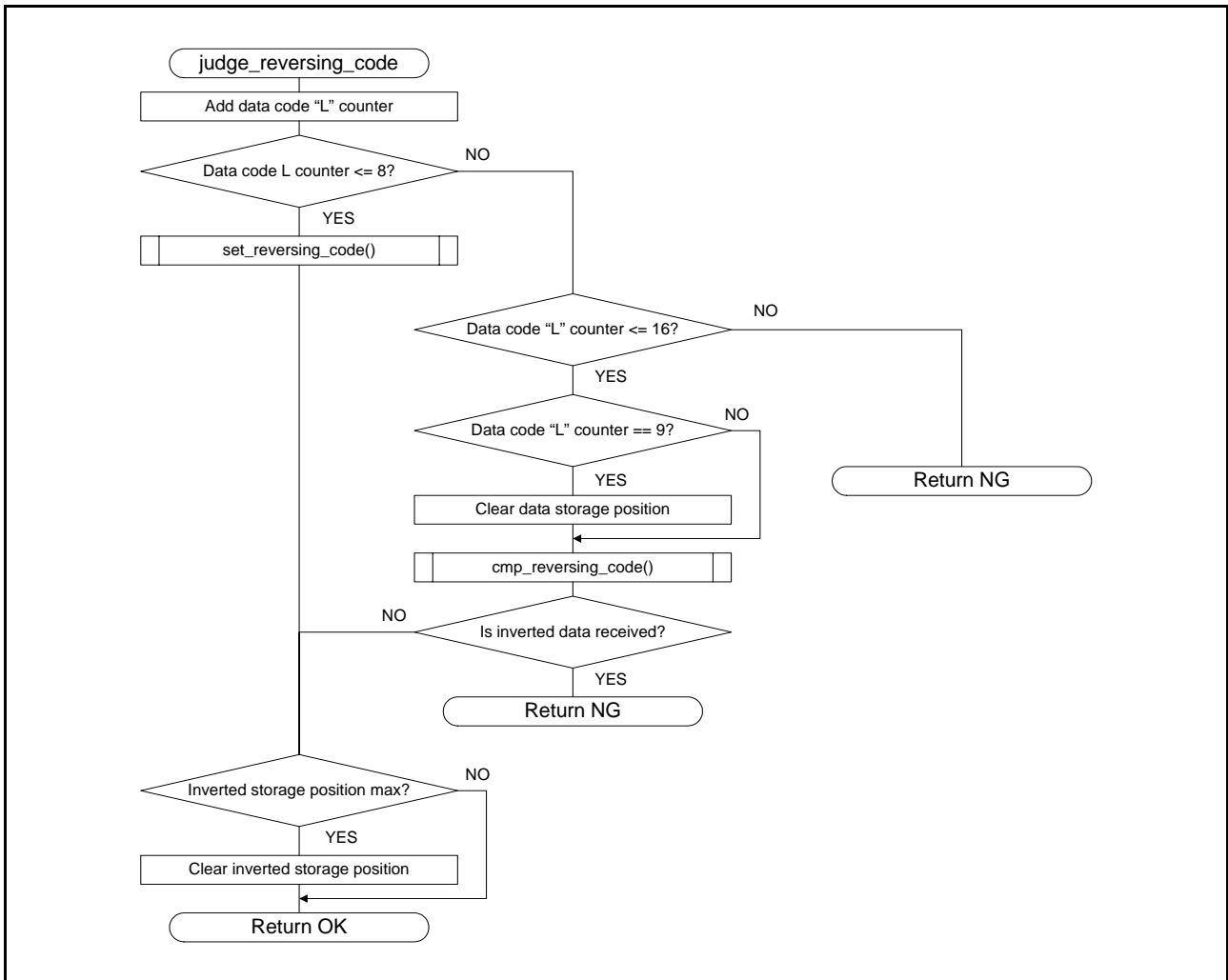

Figure 8.22 Flowchart (judge_reversing_code)

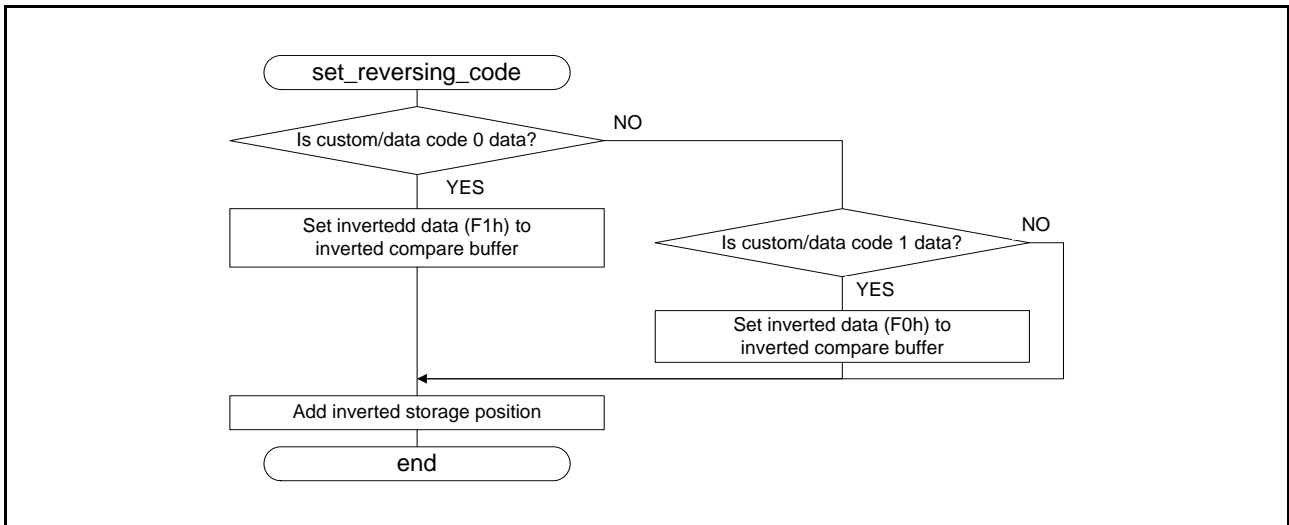

Figure 8.23 Flowchart (set_reversing_code)

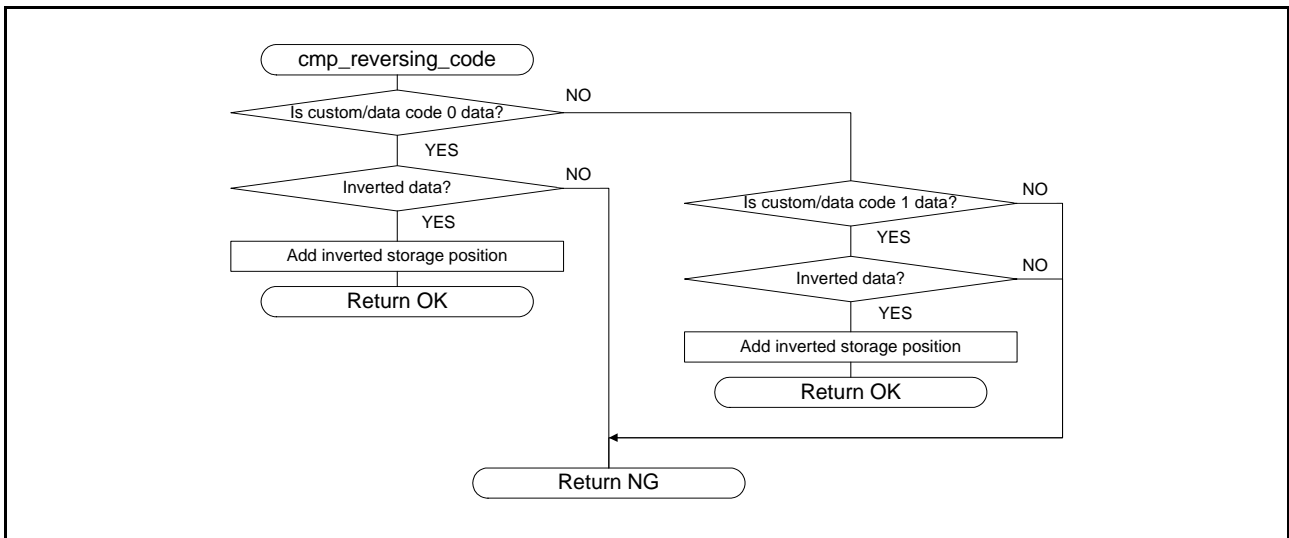

Figure 8.24 Flowchart (cmp_reversing_code)

9. Reference Documents

Hardware Manuals

M16C/28 Group Hardware Manual Rev. 1.11

M16C/29 Group Hardware Manual Rev. 1.10

The latest versions can be downloaded from the Renesas Technology website.

Technical Update/Technical News

The latest information can be downloaded from the Renesas Technology website.

Website and Support

Renesas Technology website
<http://www.renesas.com/>

Inquiries
<http://www.renesas.com/inquiry>
csc@renesas.com

REVISION HISTORY	M16C/28, 29 Group Remote Control Reception
------------------	---

Rev.	Date	Description	
		Page	Summary
1.00	Dec 10, 2006	-	First Edition issued

Notes regarding these materials

1. This document is provided for reference purposes only so that Renesas customers may select the appropriate Renesas products for their use. Renesas neither makes warranties or representations with respect to the accuracy or completeness of the information contained in this document nor grants any license to any intellectual property rights or any other rights of Renesas or any third party with respect to the information in this document.
2. Renesas shall have no liability for damages or infringement of any intellectual property or other rights arising out of the use of any information in this document, including, but not limited to, product data, diagrams, charts, programs, algorithms, and application circuit examples.
3. You should not use the products or the technology described in this document for the purpose of military applications such as the development of weapons of mass destruction or for the purpose of any other military use. When exporting the products or technology described herein, you should follow the applicable export control laws and regulations, and procedures required by such laws and regulations.
4. All information included in this document such as product data, diagrams, charts, programs, algorithms, and application circuit examples, is current as of the date this document is issued. Such information, however, is subject to change without any prior notice. Before purchasing or using any Renesas products listed in this document, please confirm the latest product information with a Renesas sales office. Also, please pay regular and careful attention to additional and different information to be disclosed by Renesas such as that disclosed through our website. (<http://www.renesas.com>)
5. Renesas has used reasonable care in compiling the information included in this document, but Renesas assumes no liability whatsoever for any damages incurred as a result of errors or omissions in the information included in this document.
6. When using or otherwise relying on the information in this document, you should evaluate the information in light of the total system before deciding about the applicability of such information to the intended application. Renesas makes no representations, warranties or guaranties regarding the suitability of its products for any particular application and specifically disclaims any liability arising out of the application and use of the information in this document or Renesas products.
7. With the exception of products specified by Renesas as suitable for automobile applications, Renesas products are not designed, manufactured or tested for applications or otherwise in systems the failure or malfunction of which may cause a direct threat to human life or create a risk of human injury or which require especially high quality and reliability such as safety systems, or equipment or systems for transportation and traffic, healthcare, combustion control, aerospace and aeronautics, nuclear power, or undersea communication transmission. If you are considering the use of our products for such purposes, please contact a Renesas sales office beforehand. Renesas shall have no liability for damages arising out of the uses set forth above.
8. Notwithstanding the preceding paragraph, you should not use Renesas products for the purposes listed below:
 - (1) artificial life support devices or systems
 - (2) surgical implantations
 - (3) healthcare intervention (e.g., excision, administration of medication, etc.)
 - (4) any other purposes that pose a direct threat to human life

Renesas shall have no liability for damages arising out of the uses set forth in the above and purchasers who elect to use Renesas products in any of the foregoing applications shall indemnify and hold harmless Renesas Technology Corp., its affiliated companies and their officers, directors, and employees against any and all damages arising out of such applications.
9. You should use the products described herein within the range specified by Renesas, especially with respect to the maximum rating, operating supply voltage range, movement power voltage range, heat radiation characteristics, installation and other product characteristics. Renesas shall have no liability for malfunctions or damages arising out of the use of Renesas products beyond such specified ranges.
10. Although Renesas endeavors to improve the quality and reliability of its products, IC products have specific characteristics such as the occurrence of failure at a certain rate and malfunctions under certain use conditions. Please be sure to implement safety measures to guard against the possibility of physical injury, and injury or damage caused by fire in the event of the failure of a Renesas product, such as safety design for hardware and software including but not limited to redundancy, fire control and malfunction prevention, appropriate treatment for aging degradation or any other applicable measures. Among others, since the evaluation of microcomputer software alone is very difficult, please evaluate the safety of the final products or system manufactured by you.
11. In case Renesas products listed in this document are detached from the products to which the Renesas products are attached or affixed, the risk of accident such as swallowing by infants and small children is very high. You should implement safety measures so that Renesas products may not be easily detached from your products. Renesas shall have no liability for damages arising out of such detachment.
12. This document may not be reproduced or duplicated, in any form, in whole or in part, without prior written approval from Renesas.
13. Please contact a Renesas sales office if you have any questions regarding the information contained in this document, Renesas semiconductor products, or if you have any other inquiries.