

Instrumentation Amplifiers

How to Bias the ISL2853x and ISL2863x High-Precision Instrumentation Amplifiers

Abstract

The inputs and outputs of Instrumentation Amplifiers (INAs) require DC biasing to operate correctly. Many textbooks neglect to point out this important requirement. Consequently, engineers new to INAs, might not know about DC biasing, which can lead to the design of nonfunctional circuits. This application note explains what DC biasing is and suggests solutions for functional circuits.

Contents

1. Input Biasing	2
1.1 DC Bridge Sensors	2
1.2 Thermocouples	2
1.3 AC-Coupled Inputs	3
2. Output Biasing	4
2.1 Ratio-Metric Applications	5
3. Revision History	6

List of Figures

Figure 1. DC Biasing of the INA Input from a Device Internal and External Perspective	2
Figure 2. Bridge Sensor as INA Signal Source	2
Figure 3. Equivalent Circuit of the Bridge Sensor Signal Source	2
Figure 4. Nonfunctional Thermocouple Circuit due to Lack of DC Bias	3
Figure 5. Properly Biased Thermocouple Circuits for Single and Dual Supply Operation.	3
Figure 6. AC-Coupling Removes the Ground Reference of the Original Input Signal, V_{IN} , so that V_{IN} is Floating.	3
Figure 7. Properly Biased Transformer-Coupled Circuits for Dual Supply and Single Supply Operation	3
Figure 8. Properly Biased Capacitor-Coupled Circuits for Dual Supply and Single Supply Operation	3
Figure 9. Diff-Amp Output is: $V_{OUT} = V_{ID} \cdot G_D + V_{REF}$	4
Figure 10. Dual Supply Operation, $V_{REF} = GND$.	4
Figure 11. Passive Drive of REF Input Introduces Voltage Error	4
Figure 12. Driving the Reference Input with a Voltage Reference IC	5
Figure 13. Proper Reference Buffering for High PSRR in Ratio-Metric Applications.	5
Figure 14. Improved Reference Buffering with 2nd Order Active Low-Pass Filter	6
Figure 15. Driving the REF Input of the ISL2863x with a Voltage Reference IC, or with a Buffered Voltage Divider.	6

Related Literature

For a full list of related documents, visit our website:

- [ISL28533](#), [ISL28534](#), [ISL28535](#), [ISL28633](#), [ISL28634](#), [ISL28635](#) device pages

1. Input Biasing

Each INA input is the base terminal of an input transistor that must be DC-biased to set the operating point of the transistor. Only then can proper device functionality be assured (Figure 1).

DC biasing is achieved by referencing the amplifier inputs using biasing resistors (R_{B+} and R_{B-}) to a reference voltage (V_{CM}) that is common to both inputs (Figure 1). V_{CM} is also known as input common-mode voltage. The resistors provide a DC current return path across which the input bias currents (I_{B+} and I_{B-}) can discharge. Also, input voltages applied to V_{IN+} and V_{IN-} are now referenced to V_{CM} and can be correctly processed by the instrumentation amplifier.

For maximum input dynamic range, make V_{CM} equal to the center of the expected input signal range.

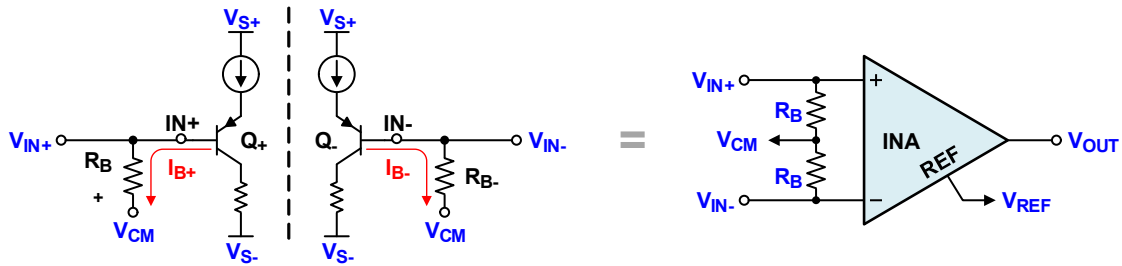

Figure 1. DC Biasing of the INA Input from a Device Internal and External Perspective

1.1 DC Bridge Sensors

Resistive bridge sensors are commonly used to convert slowly changing quantities, such as strain, pressure, and temperature, into differential output voltages. Because of their slow changes, they are DC coupled to the INA inputs.

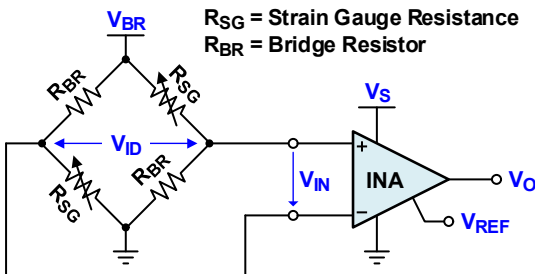

Figure 2. Bridge Sensor as INA Signal Source

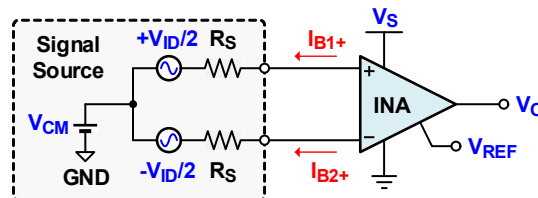

Figure 3. Equivalent Circuit of the Bridge Sensor Signal Source

$$V_{CM} = \frac{V_{BR}}{2}$$

$$\frac{V_{ID}}{2} = \frac{V_{BR}}{4} \cdot \frac{\Delta R}{R}$$

$$R_S = R_{BR} \parallel R_{SG}$$

The benefit for this type of sensor is that it represents a grounded signal source that inherently provides DC biasing to the INA inputs. Under a balanced bridge condition, the resistors in the bridge establish the input common-mode voltage, which is half the bridge supply. They also provide the DC current return path to V_{CM} for the input bias currents of the INA. Figure 3 shows the equivalent circuit of the bridge sensor as signal source.

1.2 Thermocouples

A thermocouple is a floating, temperature-dependent, DC voltage source. The lack of a ground connection at the sensor does not allow for bias currents to flow, which makes additional DC biasing at the INA inputs necessary. However, because thermocouples are inherently low-impedance devices ($R_{TC} < 2\Omega$), it suffices to bias only one INA input, as the other input is referenced through the thermocouple to the same bias potential. Figure 4 depicts a nonfunctional circuit due to the lack of DC biasing. Figure 5 shows properly biased thermocouple circuits for measuring temperatures symmetrically around 0°C , such as $\pm 150^\circ\text{C}$. Depending on the temperature range of interest, V_{CM} might be shifted to a lower voltage in the single supply circuit, or negative voltage in the dual supply circuit, to create a wider dynamic input range.

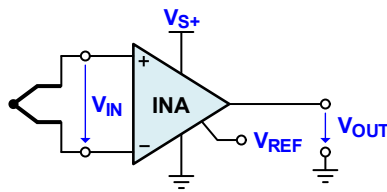

Figure 4. Nonfunctional Thermocouple Circuit due to Lack of DC Bias

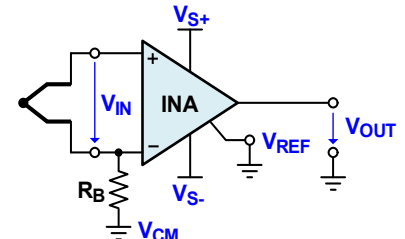
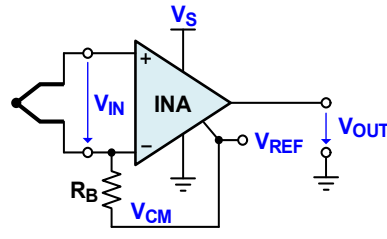

Figure 5. Properly Biased Thermocouple Circuits for Single and Dual Supply Operation

1.3 AC-Coupled Inputs

AC coupling with transformers or capacitors, removes the ground reference of the signal source and renders the circuits in [Figure 6](#) nonfunctional.



Figure 6. AC-Coupling Removes the Ground Reference of the Original Input Signal, V_{IN}' , so that V_{IN} is Floating

Applying the DC biasing introduced in [Figure 1](#), results in the properly biased transformer-coupled circuits in [Figure 7](#), and the capacitor-coupled circuits in [Figure 8](#).

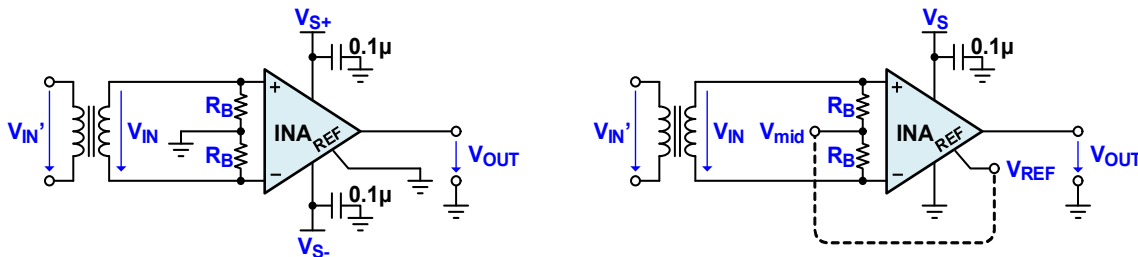

Figure 7. Properly Biased Transformer-Coupled Circuits for Dual Supply and Single Supply Operation

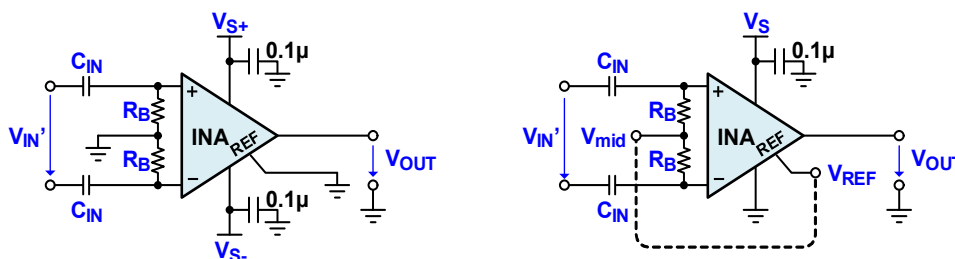

Figure 8. Properly Biased Capacitor-Coupled Circuits for Dual Supply and Single Supply Operation

Note: The coupling capacitor in combination with the bias resistors build a high-pass function with a -3dB corner frequency of $f_{-3dB} = 1/(2\pi R_B C_{IN})$. Depending on the lower bandwidth requirement, compromises are made. Using large capacitor values might be too space consuming, while using high resistor values increases input noise. The final decision should be based on the actual application requirements.

2. Output Biasing

The output stage, a unity-gain differential amplifier, removes the input common-mode voltage (V_{CM}) and adds an output common-mode voltage (V_{REF}) to the amplified, differential input signal (Figure 9).

In general, V_{REF} should be set to the center of the output dynamic range. In most applications, this is the mid-potential between the positive and negative supply rails, V_{S+} and V_{S-} . Therefore, for dual supply designs, V_{REF} is connected to ground (Figure 10).

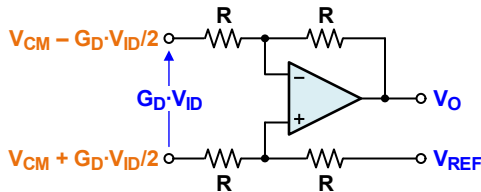

Figure 9. Diff-Amp Output is: $V_{OUT} = V_{ID} \cdot G_D + V_{REF}$

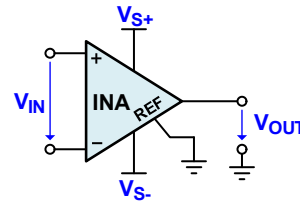

Figure 10. Dual Supply Operation, $V_{REF} = GND$

In a single supply design, however, V_{REF} must be derived from the supply. Depending on the circuit design that generates V_{REF} , it might affect the accuracy of V_{REF} , its Power Supply Rejection Ratio (PSRR), and reduce the Common-Mode Rejection Ratio (CMRR) of the diff-amp, and therefore, the entire INA.

An inexpensive method to generate V_{REF} often applied to op-amp inputs, is to derive the reference potential through a voltage divider and buffer its output with a large capacitor (Figure 11). For high-impedance op-amp inputs, this method works as the op-amp hardly loads the voltage divider circuit. The REF input of the ISL2853x however, has a 40kΩ resistance. Even when applying a 40:1 ratio for the tail-to-output current of the divider, the resulting voltage error remains significant.

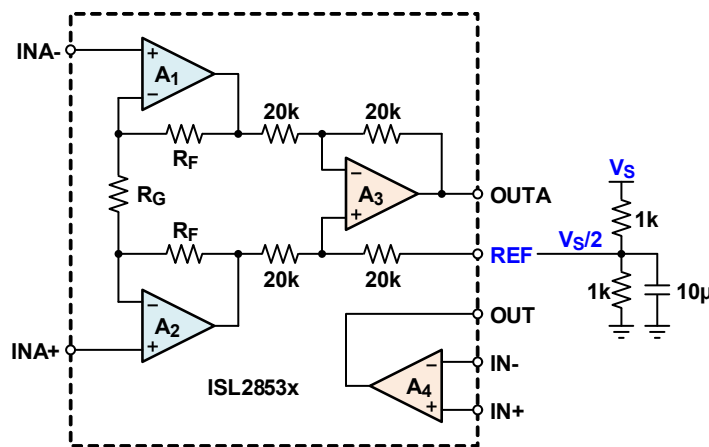

Figure 11. Passive Drive of REF Input Introduces Voltage Error

The 40:1 ratio leads to resistor values of 1kΩ. Assuming a 5V supply, results in the output voltage of the divider:

$$(EQ. 1) \quad \frac{V_S}{2} = 5V \cdot \frac{1k\Omega \parallel 40k\Omega}{1k\Omega \parallel 40k\Omega + 1k\Omega} = 2.469V$$

This represents an unacceptably high error of $\varepsilon = 100 \cdot \left(1 - \frac{2.469V}{2.5V}\right) = 1.235\%$.

Reducing the resistor values to 100Ω, results in $V_S/2 = 2.497V$ and a 0.125% error but requires a prohibitively high current of 25mA. Also, any loading of the REF input unbalances the resistor ratio in the diff-amp, which reduces the CMRR of the amplifier drastically.

To prevent these detrimental effects, the REF input can be driven by a voltage reference IC (Figure 12).

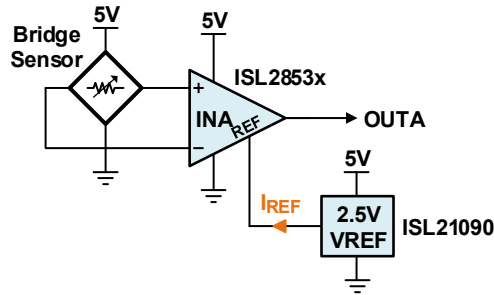

Figure 12. Driving the Reference Input with a Voltage Reference IC

An integrated voltage reference circuit provides a stable, low-noise output voltage, a low-impedance output that does not affect CMRR, and high PSRR that makes it immune to supply voltage noise.

To ensure a consistent output dynamic range, designers even supply the instrumentation amplifier from a voltage reference IC.

2.1 Ratio-Metric Applications

Ratio-metric circuits derive the reference voltage from the system supply to ensure that V_{REF} remains $V_S/2$ during slow supply changes. Figure 13 shows the level of V_{REF} being established with a high-impedance voltage divider to minimize current loading on the supply.

To maintain a high PSRR, a large 100µF capacitor, C_{IN} , is connected parallel to R_2 . This capacitor, in combination with the parallel circuit of R_1 and R_2 , forms a low-pass filter for supply voltage ripples. Its -3dB frequency is calculated with $f_{-3dB} = 1/(2\pi R_1 || R_2 C_{IN})$. For the circuit below, $f_{-3dB} = 32\text{mHz}$.

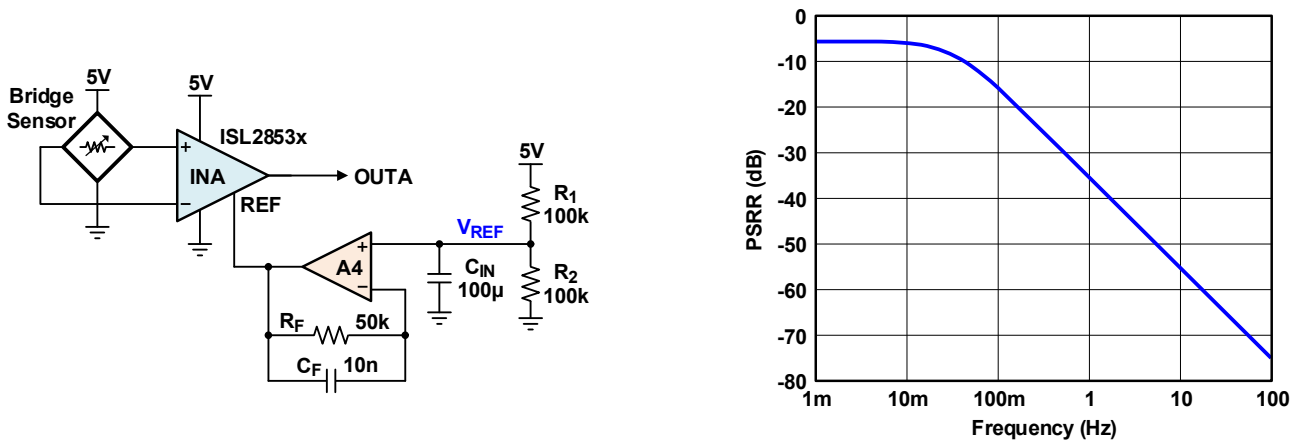

Figure 13. Proper Reference Buffering for High PSRR in Ratio-Metric Applications

Note: C_{IN} must have low leakage across the operating temperature range, as every nA in leakage current causes a 50µV drop in V_{REF} . Therefore, at 1µA leakage current, V_{REF} drops by 50mV, resulting in a 2% error.

The voltage divider output is buffered with a unity-gain buffer, which requires the addition of a second op-amp. Fortunately, the ISL2853x amplifier also provides an uncommitted high-precision op-amp, A4, which is used as a reference buffer.

The PSRR plot shows that supply changes slower than 10mHz result in reference changes of the same frequency. Faster changes than that are filtered following a 1st order low-pass response.

Although the op-amp operates at unity-gain, a feedback resistor (R_F) is required to minimize the input offset due to bias currents. Its value should match the parallel combination of R_1 and R_2 : $R_F = R_1 || R_2$. The small capacitor (C_F) minimizes resistor noise.

An even more elegant solution, using much smaller capacitor values, is the 2nd order active low-pass filter in [Figure 15](#). Making $C_2 = 2 \cdot C_1$ increases the quality factor to $Q = \sqrt{C_2/4C_1} = 0.707$, therefore, generating a sharper pass-to-stop band transition.

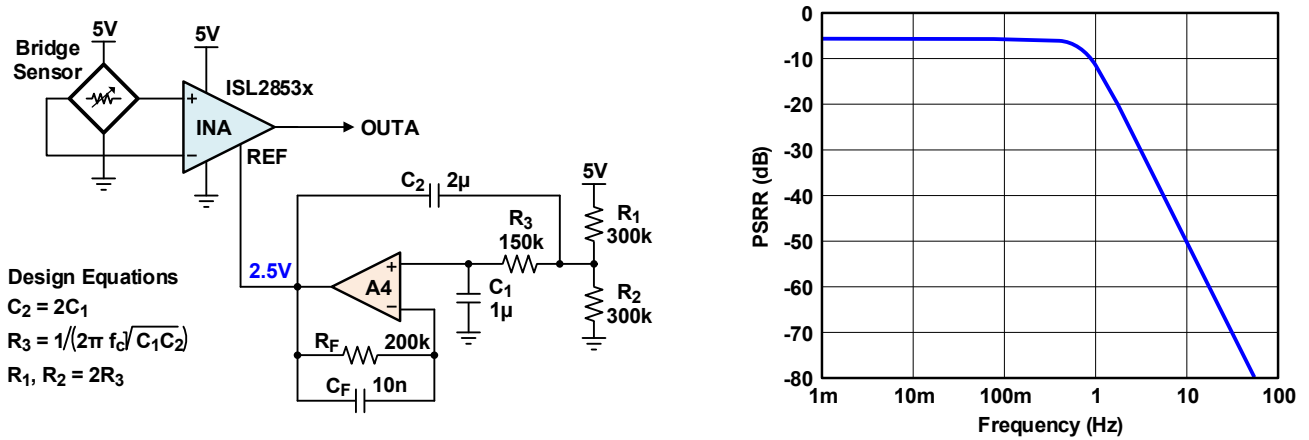

Figure 14. Improved Reference Buffering with 2nd Order Active Low-Pass Filter

This PSRR plot shows that supply changes up to 0.5Hz are tolerated while rejecting supply noise of 20Hz by about 60dB, the same amount as the previous circuit.

Note: The REF input of the ISL2863x instrumentation amplifier with differential output is internally buffered. Here, the reference input can be driven either with an integrated reference circuit, or with an external voltage divider similar to the one in [Figure 15](#). Any additional low-pass filtering though, requires an additional op-amp.

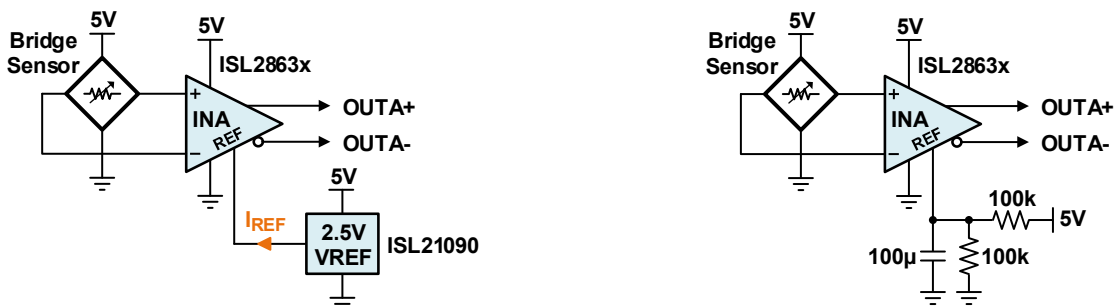

Figure 15. Driving the REF Input of the ISL2863x with a Voltage Reference IC, or with a Buffered Voltage Divider

3. Revision History

Rev.	Date	Description
1.00	May.20.20	Initial release

IMPORTANT NOTICE AND DISCLAIMER

RENESAS ELECTRONICS CORPORATION AND ITS SUBSIDIARIES (“RENESAS”) PROVIDES TECHNICAL SPECIFICATIONS AND RELIABILITY DATA (INCLUDING DATASHEETS), DESIGN RESOURCES (INCLUDING REFERENCE DESIGNS), APPLICATION OR OTHER DESIGN ADVICE, WEB TOOLS, SAFETY INFORMATION, AND OTHER RESOURCES “AS IS” AND WITH ALL FAULTS, AND DISCLAIMS ALL WARRANTIES, EXPRESS OR IMPLIED, INCLUDING, WITHOUT LIMITATION, ANY IMPLIED WARRANTIES OF MERCHANTABILITY, FITNESS FOR A PARTICULAR PURPOSE, OR NON-INFRINGEMENT OF THIRD PARTY INTELLECTUAL PROPERTY RIGHTS.

These resources are intended for developers skilled in the art designing with Renesas products. You are solely responsible for (1) selecting the appropriate products for your application, (2) designing, validating, and testing your application, and (3) ensuring your application meets applicable standards, and any other safety, security, or other requirements. These resources are subject to change without notice. Renesas grants you permission to use these resources only for development of an application that uses Renesas products. Other reproduction or use of these resources is strictly prohibited. No license is granted to any other Renesas intellectual property or to any third party intellectual property. Renesas disclaims responsibility for, and you will fully indemnify Renesas and its representatives against, any claims, damages, costs, losses, or liabilities arising out of your use of these resources. Renesas' products are provided only subject to Renesas' Terms and Conditions of Sale or other applicable terms agreed to in writing. No use of any Renesas resources expands or otherwise alters any applicable warranties or warranty disclaimers for these products.

(Rev.1.0 Mar 2020)

Corporate Headquarters

TOYOSU FORESIA, 3-2-24 Toyosu,
Koto-ku, Tokyo 135-0061, Japan
www.renesas.com

Contact Information

For further information on a product, technology, the most up-to-date version of a document, or your nearest sales office, please visit:
www.renesas.com/contact/

Trademarks

Renesas and the Renesas logo are trademarks of Renesas Electronics Corporation. All trademarks and registered trademarks are the property of their respective owners.