

Bluetooth LE MCU

Bluetooth Test Tool Suite operating instructions

Introduction

This document describes the GUI software "Bluetooth Test Tool Suite" which controls Renesas *Bluetooth*[®] Low Energy (hereinafter Bluetooth LE) MCU (hereinafter MCU) from Windows PC.

Target Device (MCU)

RX23W Group

RA4W1 Group

RE01B Group

Contents

1. Overview.....	4
1.1 Feature	4
1.2 Scope of application	4
1.3 Restrictions.....	5
1.4 Operational Environment.....	5
2. Installation	7
2.1 Contents	7
2.2 Installation procedure	7
2.3 About uninstallation	7
3. Common operation	9
3.1 Initial setting.....	9
3.1.1 Write HCI mode firmware	9
3.1.2 COM port setting	9
3.2 Tool launcher start-up and tool selection	11
3.3 The EVB connection and disconnection	12
3.4 Termination of Tool and Tool Launcher	13
4. Common functions.....	14
4.1 Status display	14
4.2 Log output.....	14
4.2.1 API · Event log display · output.....	14
4.2.2 HCI log output	15
5. Evaluate RF.....	17
5.1 Transmit Continuous Wave data	17
5.1.1 Transmission Wave.....	18

5.1.2	Transmit frequency channel	18
5.1.3	Transmit power	19
5.1.4	Transmission Start / Stop	19
5.2	Evaluate with Direct Test Mode.....	20
5.2.1	DTM transmit / receive operation	22
5.2.2	DTM reception result display.....	25
6.	Evaluate the Beacon function.....	27
6.1	Transmit Beacon data	27
6.1.1	Advertising handle.....	27
6.1.2	Advertising transmit power	28
6.1.3	Legacy / Extension Advertising switching	28
6.1.4	Legacy / Extension Advertising Common Settings	29
6.1.5	Legacy Advertising Settings	29
6.1.6	Extension Advertising Settings.....	31
6.1.7	Advertising start / stop.....	34
6.1.8	Saving advertising handle properties	34
6.2	Receive Beacon data	35
6.2.1	Scanning mode	35
6.2.2	PHY and Scanning operation settings	36
6.2.3	Filter settings	36
6.2.4	Scanning start / stop.....	37
6.2.5	Display of Advertisement Data.....	38
7.	Evaluate Data Communication functions.....	39
7.1	Service definition	39
7.2	Measure the throughput with the smartphone as the opposing device.....	40
7.2.1	Advertising start (MCU side)	40
7.2.2	Scanning start / connection (smartphone side).....	41
7.2.3	Notification transmission permission setting (Smartphone side)	43
7.2.4	Notification transmission start (MCU side)	43
7.2.5	Throughput confirmation (MCU side)	45
7.3	Measure the throughput with the MCU as the opposing device	46
7.3.1	Advertising start (Slave side).....	47
7.3.2	Scanning start / connection (Master side).....	47
7.3.3	RF setting / Connection interval setting (Slave side)	50
7.3.4	RF setting, Connection interval setting, ATT_MTU setting (Master side).....	50
7.3.5	Notification transmission throughput measurement (Slave side).....	52
7.3.6	Write without response transmission throughput measurement (Master side).....	54
7.4	Pairing Execution	56
7.4.1	Pairing with the smartphone.....	56
7.4.2	Pairing between MCUs.....	62

7.4.3	Save / Load of the Pairing Information.....	66
8.	Use BTTS in the Radio Law Certification Test	69
8.1	CW (non-modulated continuous wave) Transmission.....	70
8.2	Continuous Transmission of a Pseudo-Random Bit Sequence	71
8.3	Reception	72
8.4	Scanning.....	73
8.4.1	Execute Advertising.....	73
8.4.2	Execute Scanning	74
	Revision History	75

The *Bluetooth*[®] word mark and logos are registered trademarks owned by Bluetooth SIG, Inc. and any use of such marks by Renesas Electronics Corporation is under license. Other trademarks and trade names are those of their respective owners.

1. Overview

1.1 Feature

Bluetooth Test Tool Suite (hereinafter BTTS) is a tool suite to control MCU evaluation board (hereinafter EVB) connected with Windows PC and USB Serial and evaluate three functions of RF, beacon and Data Communication in Bluetooth (Core Specification) 5.0.

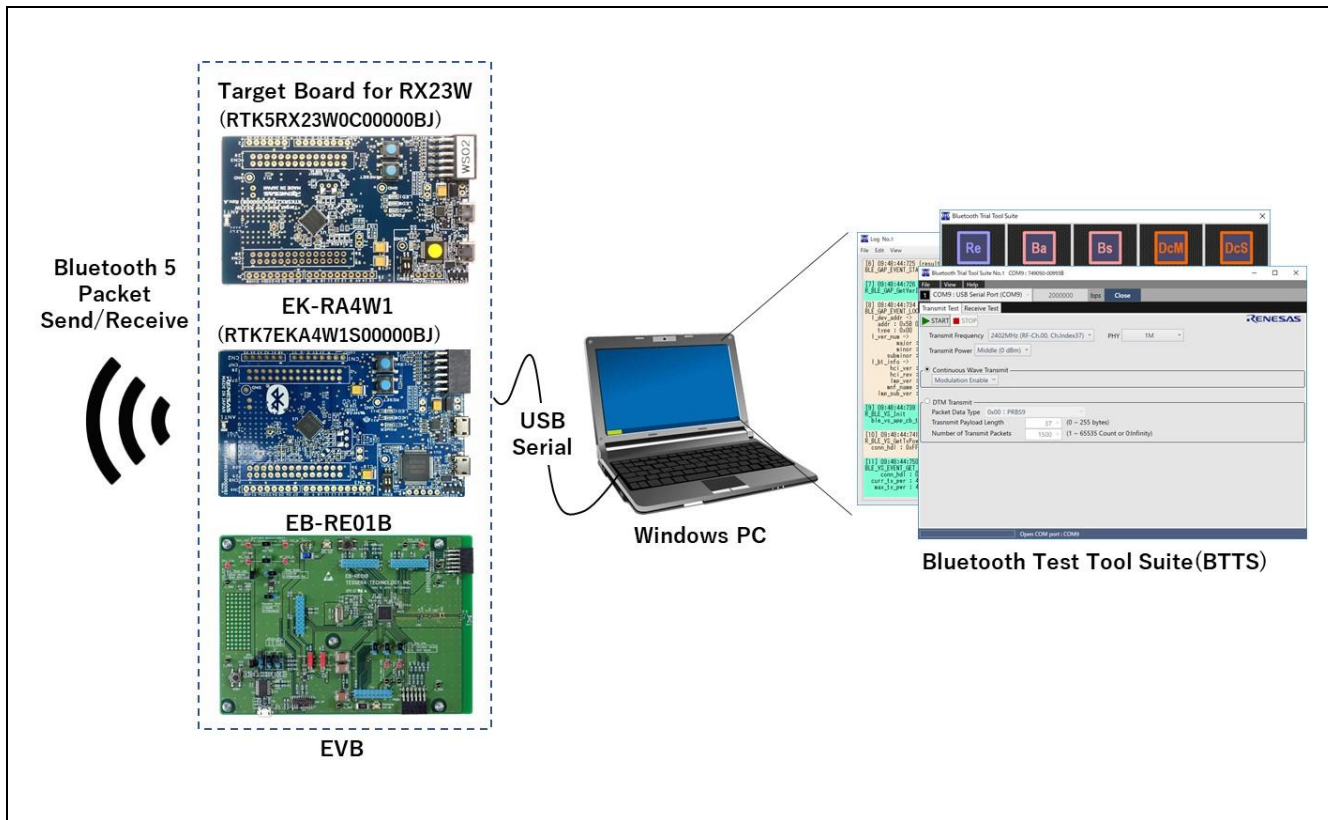

Figure 1-1. BTTS outline diagram

When operating the GUI on the BTTS, the API of Bluetooth protocol stack is called according to the function operated. The API is internally replaced with the Host Controller Interface (HCI) command and sent to the MCU side. BTTS displays the contents of the sent command and the received event as a result on the GUI. The "Log" window outputs the API and events of the Bluetooth protocol stack used by BTTS and their parameter information, which can be serve as a reference when developing the Bluetooth application products.

This document describes the constitution, installation, and usage of BTTS.

For details on the API of the Bluetooth protocol stack, refer to the following documents of each MCU.

- RX23W :
The "API Reference Manual" included in the Bluetooth Low Energy Protocol Stack Basic Package.
- RA4W1 :
The "RA Flexible Software Package Documentation" included in the FSP package.
- RE01B :
The "API document" included in the RE01B Group Bluetooth Low Energy Sample code (using CMSIS Driver Package).

1.2 Scope of application

The contents of this document apply to BTTS 1.06 and later. The contents may be revised by the function addition etc. of BTTS .

1.3 Restrictions

- The BTTS described in this document can be used only for evaluating the Bluetooth function of MCU. It cannot be used for other purposes.
- Depending on the communication load, application processing may not be in time, and data may be lost or data corruption, causing BTTS to terminate abnormally. The frequency of abnormal termination can be reduced by the following measures.
 - Enable address filter when scanning (see 6.2.3 and 7.3.2)
 - Do not perform bidirectional data communication
 - Reduce the processing load on the tool by turning off the log display function (see 4.2.1)

1.4 Operational Environment

The following operating environment is required for BTTS execution.

- MCU mounting board (Firmware for HCI operation already written)
The following EVB is used in this document.
 - EVB for RX23W: Target Board for RX23W (RTK5RX23W0C00000BJ)
 - EVB for RA4W1: EK-RA4W1 (RTK7EKA4W1S00000BJ)
 - EVB for RE01B: EB-RE01B ([TESSERA TECHNOLOGY INC.](http://www.tessera.com))
- Windows 10 (64-bit version) PC
- Connection cable
The configuration on the MCU mounting board differs depending on the connection cable used.
 - When using USB cable
Connect to MCU Serial Communication Interface (SCI) I/O terminals (TXD, RXD, CTS) via USB connector and FTDI chip. Use the USB A-MicroB cable to connect to the EVB described in this document.

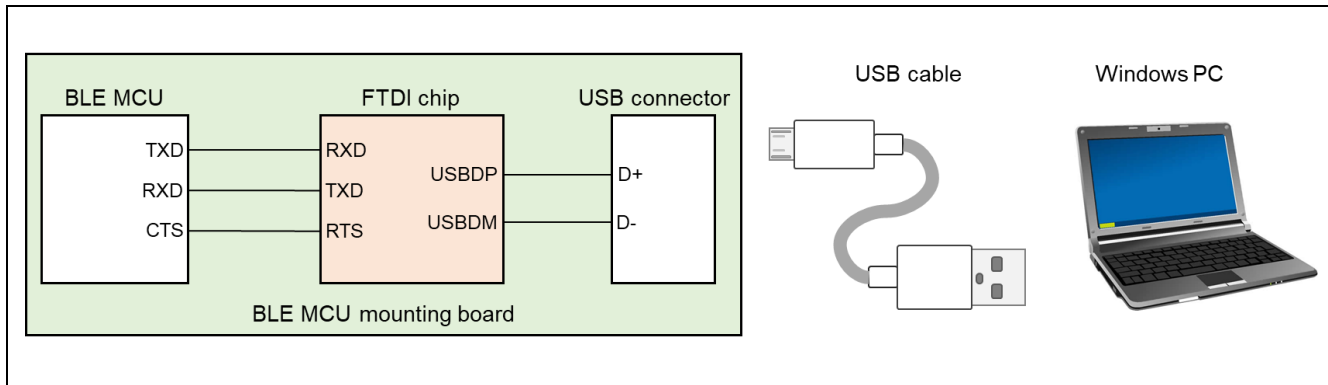

Figure 1-2. When using USB cable

- When using FTDI cable
Connect to the MCU SCI I/O terminals (TXD, RXD, CTS) via a general-purpose connector etc.

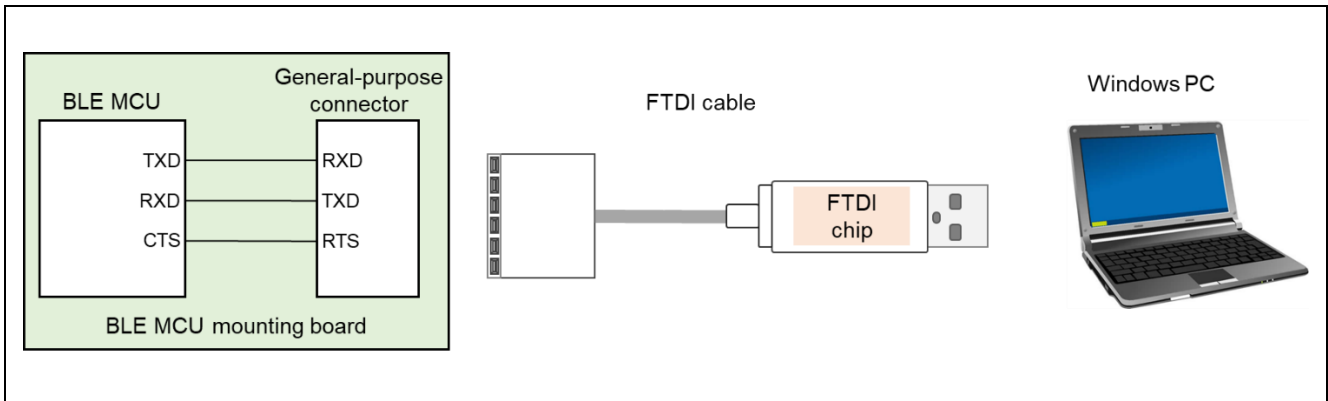

Figure 1-3. When using FTDI cable

- Notes: 1. The pin numbers of the SCI I/O terminals change depending on the channel used. Please refer to each MCU user's manual for SCI.
RX23W Group User's Manual: Hardware (R01UH0823) — "SCI8"
RA4W1 Group User's Manual: Hardware (R01UH0883) — "SCI4"
RE01B Group User's Manual: Hardware (R01UH0903) — "SCI2"
2. "FTDI" is a generic term for Future Technology Devices International Limited's products used to convert USB and serial interfaces. Please obtain the datasheet or device driver of the chip or cable that can convert USB to UART from the following URL.
<https://www.ftdichip.com/>

2. Installation

2.1 Contents

The file and folder structure of the BTTS package is shown below.

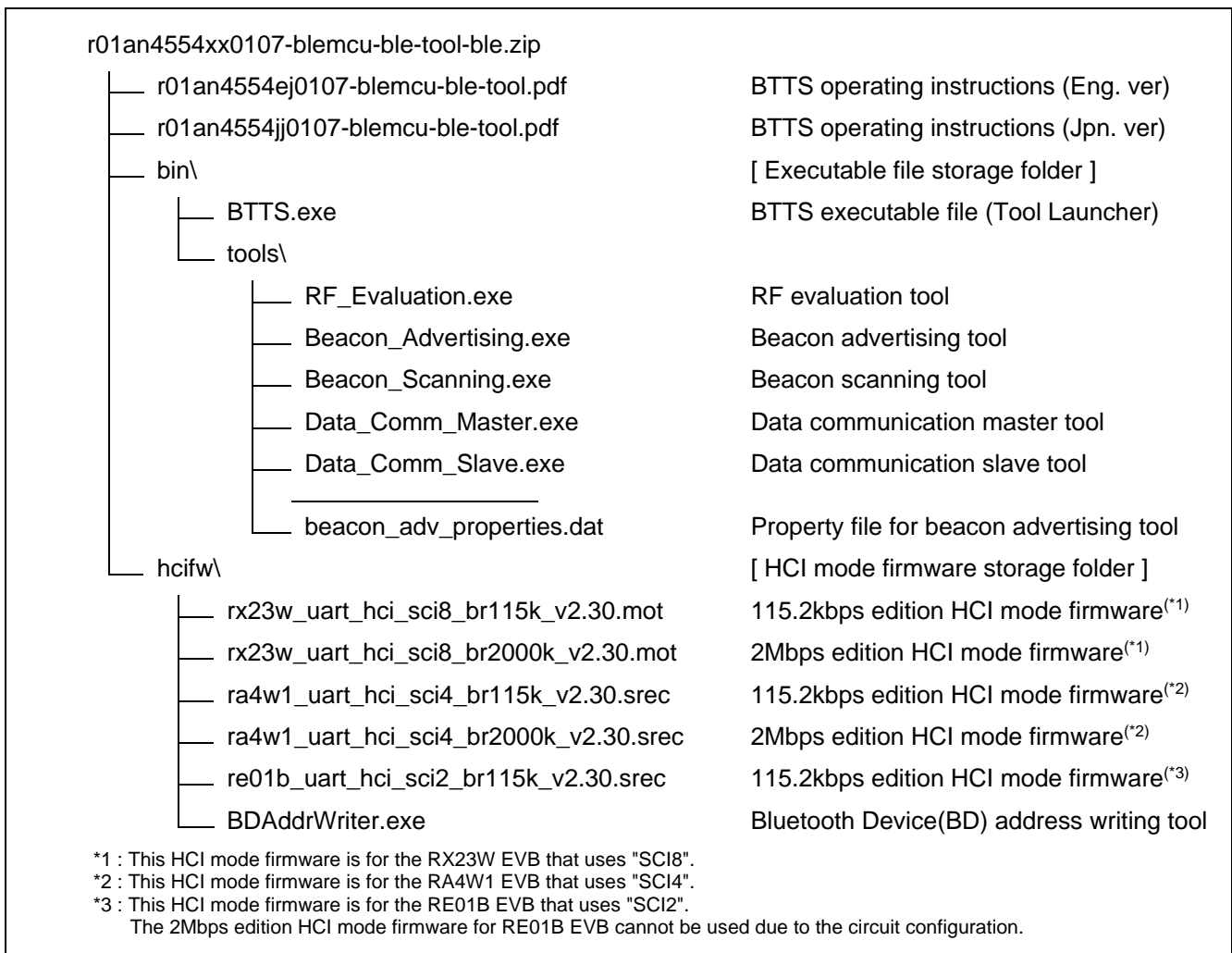

Figure 2-1. BTTS Package Contents List

2.2 Installation procedure

Please unpack the BTTS package (zip file) to an arbitrary folder. Compare with the package list shown in Figure 2-1, please confirm that the file is not insufficient.

Note: Please uninstall the old version before installing the new version.

2.3 About uninstallation

When uninstalling BTTS, delete the expanded folder. BTTS does not use Windows registry for installation and execution.

Application properties are automatically saved in the folders below. When uninstalling please delete the folder which is automatically generated in the following folder.

C:\Users\ (User name) \AppData\Local\BTTS

Figure 2-2. BTTS application properties save folder

3. Common operation

3.1 Initial setting

3.1.1 Write HCI mode firmware

With the BTTS, high-load communication occurs between the Windows PC and the EVB, so the EVB HCI mode firmware uses the baud rate 2Mbps edition. Write the "xxxxx_uart_hci_scix_br2000k_vx.xx.xxx" file in the HCI mode firmware storage folder in the extracted package to the EVB.

Also, BD address (public address) of the EVB may be lost by writing HCI mode firmware. If it disappears, use the BD address rewriting tool "BDAddrWriter.exe" in the HCI mode firmware storage folder to write the public address.

Even if the public address is invalid, the BTTS will instead use a fixed random (static) address for each device generated from the MCU's unique ID, so the application works normally.

Refer to the following documents of each MCU for how to write HCI mode firmware and BD address.

- RX23W :
Bluetooth Low Energy Protocol Stack Basic Package User's Manual (R01UW0205)
- RA4W1 :
Host Controller Interface Firmware (R01AN5429)
Public BD Address writing tool (R01AN5439)
- RE01B :
The "API document" included in the RE01B Group Bluetooth Low Energy Sample code (using CMSIS Driver Package) (R01AN5606)

Note: When using baud rate of 115.2kbps for communication with devices such as RF testers, write the "xxxxx_uart_hci_scix_br115k_vx.xx.xxx" file for each MCU in the HCI mode firmware storage folder to the EVB.

Note: RE01B does not support BD address writing by "BDAddrWriter.exe". You need to write the BD address using the Renesas Flash Programmer.

Note: RE01B cannot use the 2Mbps edition HCI mode firmware due to circuit configuration of the EVB. Please use the 115.2kbps edition HCI mode firmware.

3.1.2 COM port setting

Note: This setting is a USB driver setting to reduce the time loss during data transfer between Windows PC and EVB. This setting increases the frequency of interrupts and will be heavy the load on the system. If the purpose of using the tools is not performance evaluation, there is no need to make this setting.

The first time you connect the EVB to a Windows PC with a USB cable, the installation of the USB Communication Device Class (CDC) driver will begin automatically. After installation is complete, start Device Manager. The COM port used by the connected the EVB is displayed in the category "Ports (COM and LPT)" on the device manager.

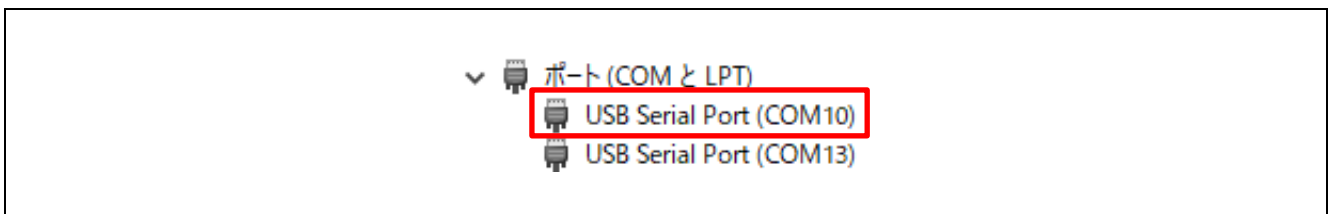

Figure 3-1. Device manager COM port setting

Select the applicable COM port, press the right mouse button and select "Properties". Click "Advanced" on the "Port Settings" tab from the displayed COM port properties. To shorten the data transfer time (waiting time until data is received and transferred to the USB host side) from the displayed advanced setting panel,

set the pull-down menu (default is "16") of "Latency Timer (msec)" of "BM options" to "1" and click the "OK" button.

Then close the property dialog to apply the settings.

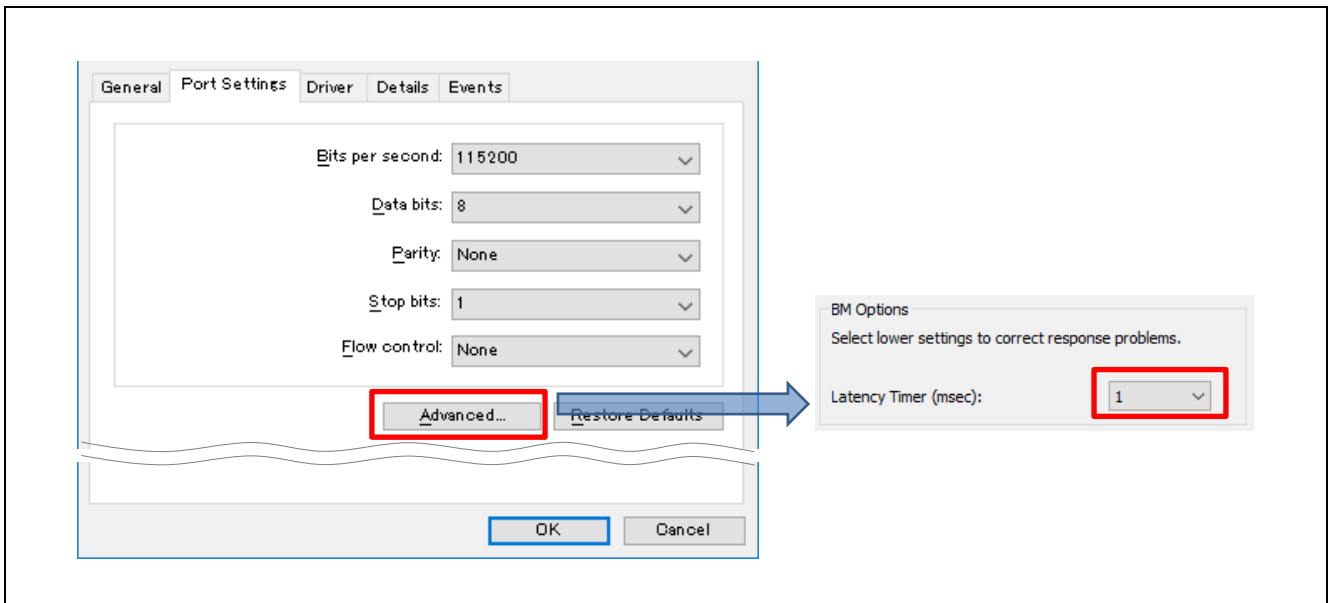

Figure 3-2. Port setting

3.2 Tool launcher start-up and tool selection

To start BTTS, execute "BTTS.exe" located in the executable file storage folder in the unzipped package.

When executed, the tool launcher for selecting five tools is displayed. Select and click the tool to be executed from the tool launcher. This tool launcher is always displayed.

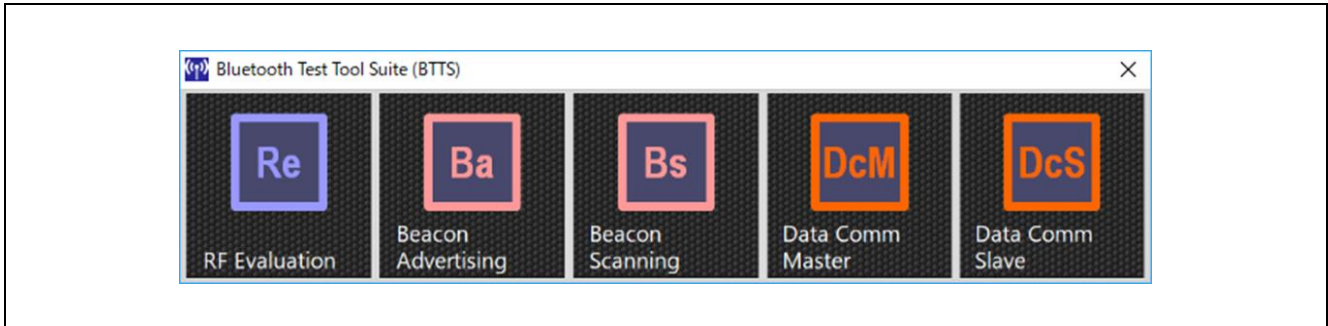

Figure 3-3. Tool launcher

- RF Evaluation tool
Select "RF Evaluation" for certification test and RF evaluation of Direct Test Mode.
- Beacon (advertising / scanning) tool
Select to evaluate beacon communication function using the extension advertising and the periodic advertising functions. Select "Beacon Advertising" to perform advertising or select "Beacon Scanning" to perform scanning.
- Data Communication (Master / Slave) tool
Select to evaluate the pairing security function and the data communication function for throughput measurement. Select "Data Comm Master" to perform master operation and select "Data Comm Slave" to perform slave operation.
When connecting with a smartphone, select "Data Comm Slave" to execute slave operation possess GATT database.

3.3 The EVB connection and disconnection

When start a tool, identification numbers are assigned and displayed in order from "1" for each tool in the title bar of each tool window.

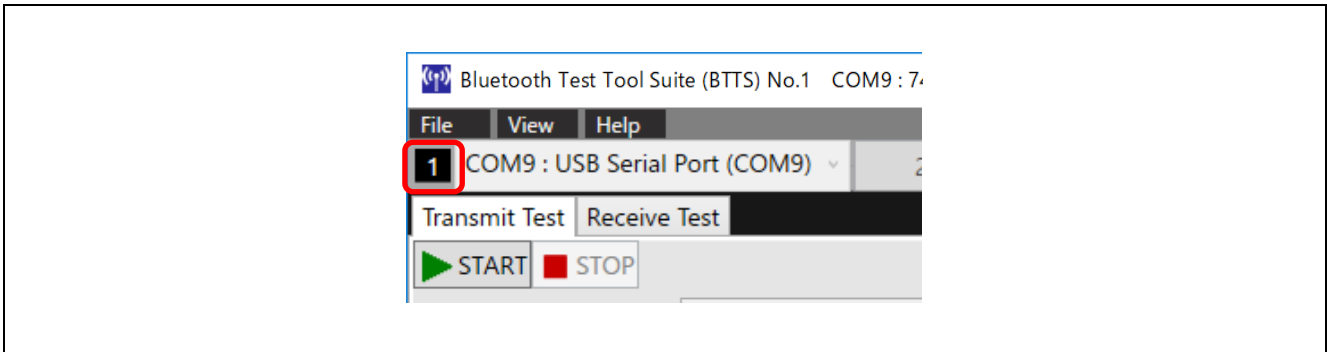

Figure 3-4. Identification ID number display

COM ports connected to the Windows PC are displayed as a connection candidate in the pull-down menu for connection port selection. COM ports that have already been selected by another tool are displayed add "(In use)" indicating that they are in use.

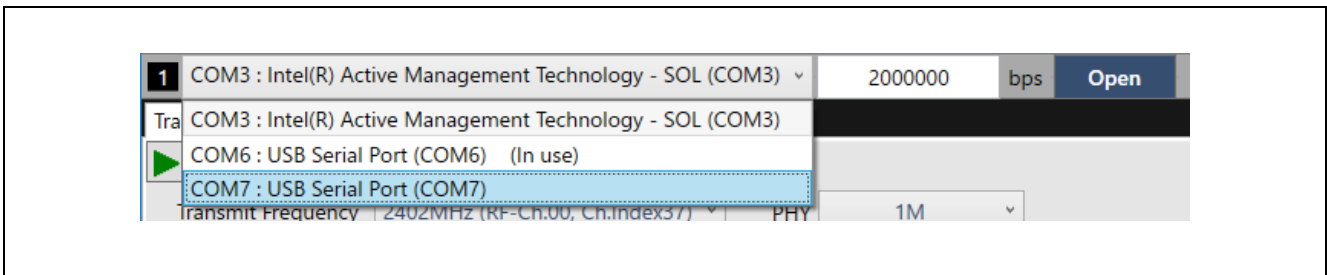

Figure 3-5. Connection port selection

The baud rate value used to connect to the EVB is set by directly entering in the text box. This parameter is reflected in the serial communication setting on the connected the EVB side. With the BTTS, set "2000000" (2Mbps) or "115200" (115.2kbps).

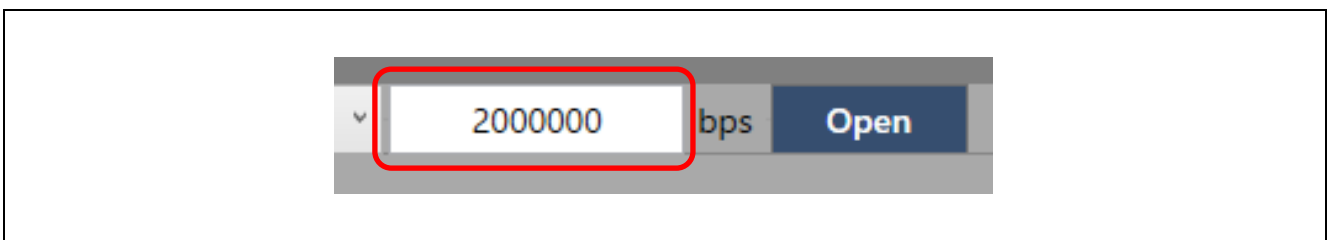

Figure 3-6. Baud rate setting

After selecting the COM port and setting the baud rate used for connection, click the "Open" button. When connection with the EVB is successful, the button display switches to "Close". Communication with the EVB is disconnected by clicking this "Close" button. After disconnection, the button display changes to "Open".

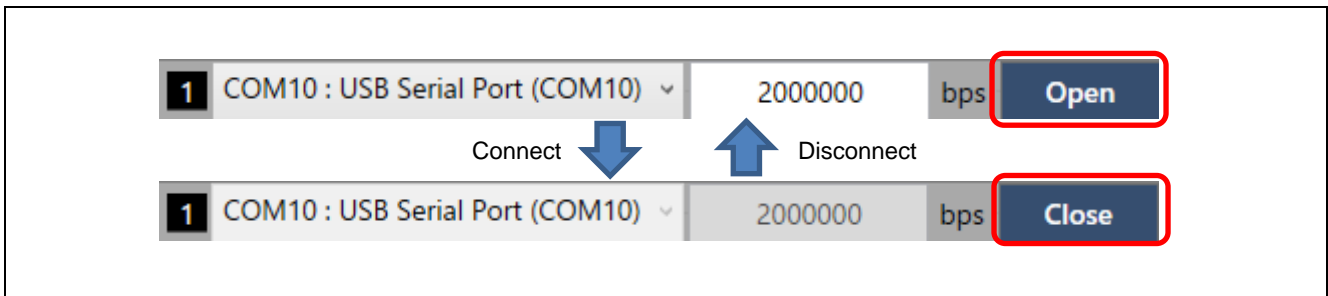

Figure 3-7. Connection button display

3.4 Termination of Tool and Tool Launcher

The termination procedure of each tool is as follows.

1. If communication is in progress, click the "■STOP" button to stop communication.
2. If COM port is opening, click the "Close" button to close the port.
3. Click the "Close (x)" button on the window to terminate the tool.

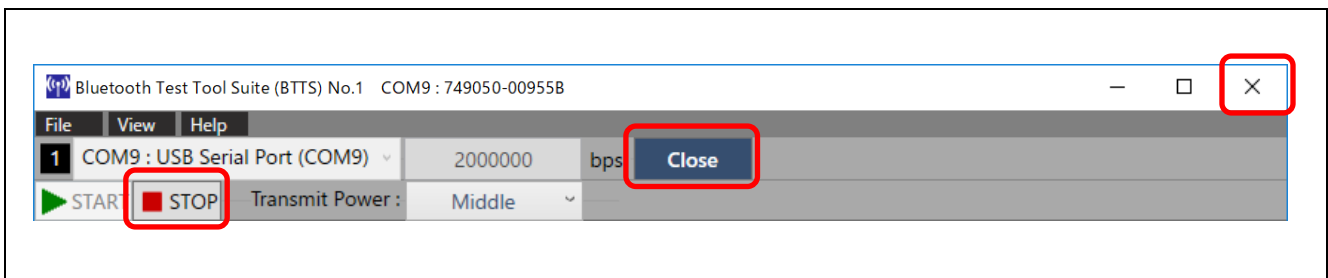

Figure 3-8. Termination of Tool

The tool launcher terminate by clicking the "Close (x)" button on the window.

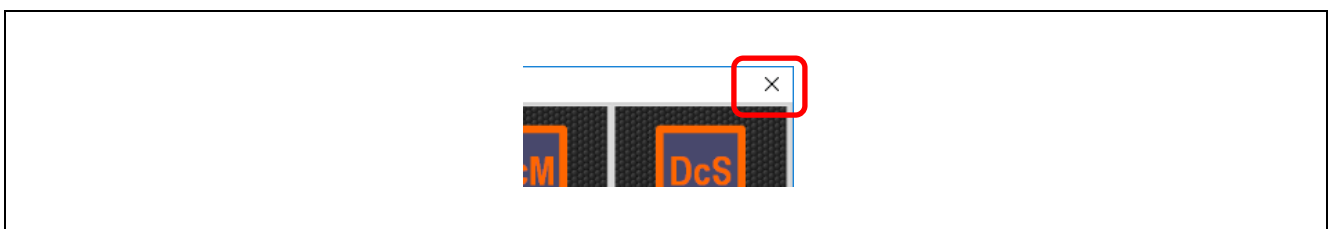

Figure 3-9. Termination of Tool Launcher

The properties of each tool are automatically saved by the termination process.

4. Common functions

4.1 Status display

The status display part at the bottom of the window displays a progress bar while controlling the MCU using the GUI and waiting for its response.

The string field on the right of the progress bar displays feedback information from the MCU.

While the function to output the HCI log to a file (see 4.2.2 below) is selected, "●REC" is displayed at the right end of the status bar.



Figure 4-1. Status display example

4.2 Log output

BTTs has a function to display the API and the Event log of Bluetooth protocol stack used to control MCU in the "Log" window and output it to a file, and a function to output a Host Controller Interface (HCI) log to a file.

4.2.1 API - Event log display - output

When you select a tool to evaluate in the tool launcher, the "Log" window is displayed separately from the operation window of each tool. In this window, the API of Bluetooth protocol stack called by GUI operation, the parameter at the time of the API call, and the information of the event and the event structure notified from Bluetooth protocol stack by the API call are displayed.

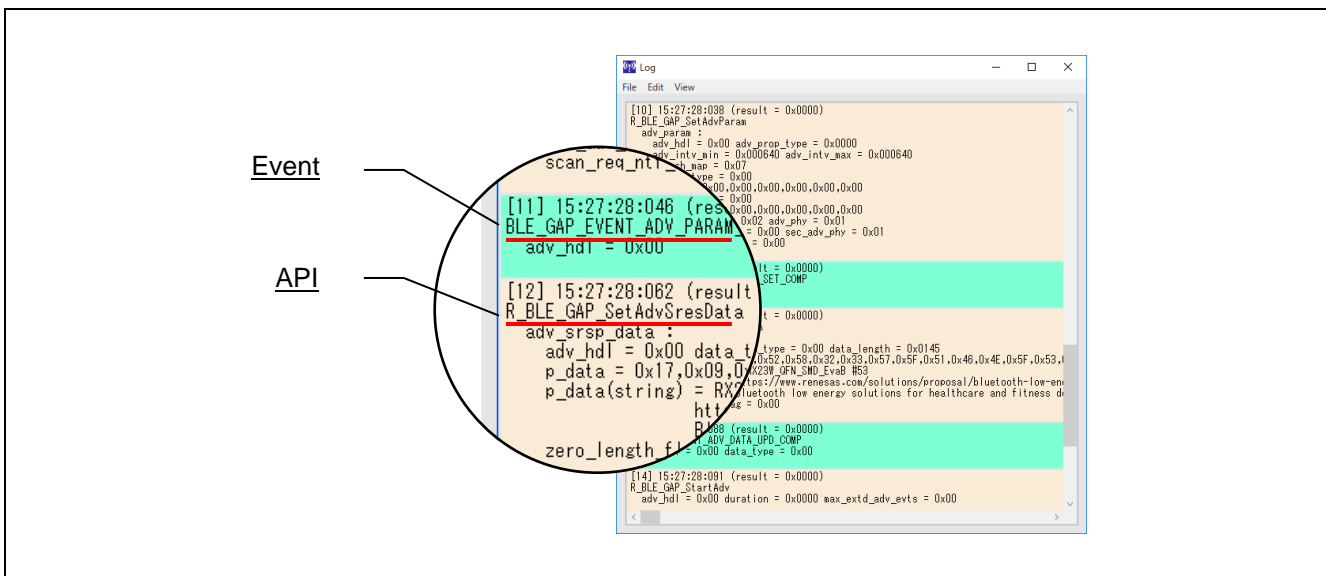

Figure 4-2. "Log" window

- By selecting "Save" from the "File" menu on the top menu bar of the "Log" window, you can save the log as a text file of any name in any folder.
- You can clear all the logs displayed in the window by selecting "Clear" of the "Edit" menu.

- You can stop the log output by unchecking the "Log Output ON" in the "View" menu. By default, the check is ON.

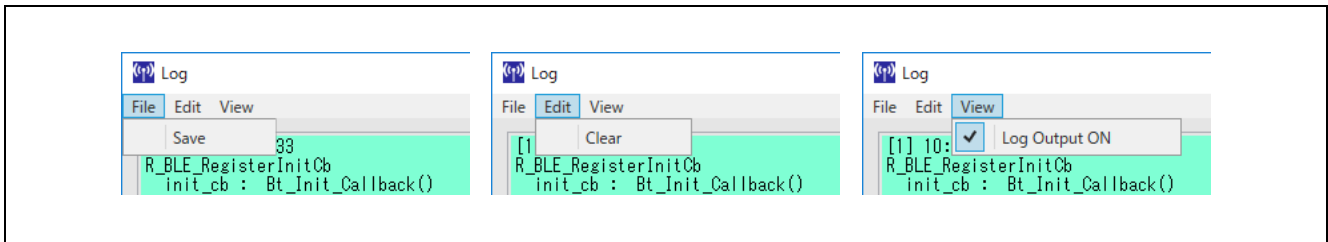

Figure 4-3. Menu bar: "File" "Edit" "View" menu

Note: When measuring the throughput of the Data Communication, the performance is improved by reducing the processing load on the log display by unchecking the "Log Output ON".

4.2.2 HCI log output

The HCI log output function generates log files in the folder where BTTS.exe is stored on Windows and saves log data of HCI commands and events that the Bluetooth protocol stack transmits and receives with the MCU.

This function is enabled by checking "HCI Log Save" in the "File" menu of the menu bar at the top of each tool operation window. While "HCI Log Save" is checked, "●REC" is displayed in the status bar at the bottom of the operation window.

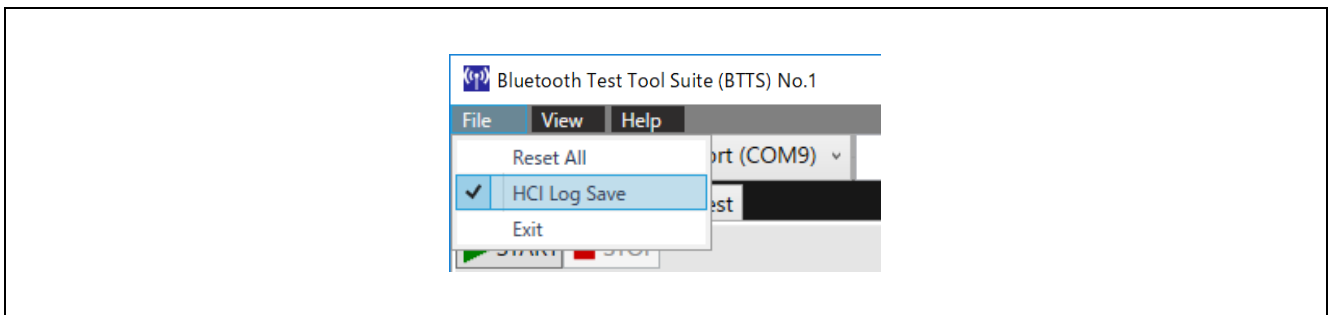

Figure 4-4. Menu bar: "File"-"HCI Log Save" menu



Figure 4-5. Status bar: display of during the HCI log output

The saved HCI log files can be browsed by an application that targets HCI logs such as the "Wireshark". (Confirmed that browsing is possible in Wireshark version 3.2.1.)

The HCI log file is output with the file name "<Tool identifier >_yyyy_mm_dd_hh_mm_ss.snoop". As the time, the log acquisition start time is set. The <Tool identifier> are as shown in Table 4-1.

Table 4-1. Tool identifier attached to HCI log file

Tool selected in tool launcher		Tool identifier
RF Evaluation		RFEva
Beacon	Advertising	BeaconAdv
	Scanning	BeaconScan
Data Communication	Master	DataCommMaster
	Slave	DataCommSlave

5. Evaluate RF

This chapter describes the RF Evaluation tool using the MCU.

5.1 Transmit Continuous Wave data

Select "RF Evaluation" in the tool launcher to start the RF evaluation tool. Connect the EVB according to the procedure described in 3.3.

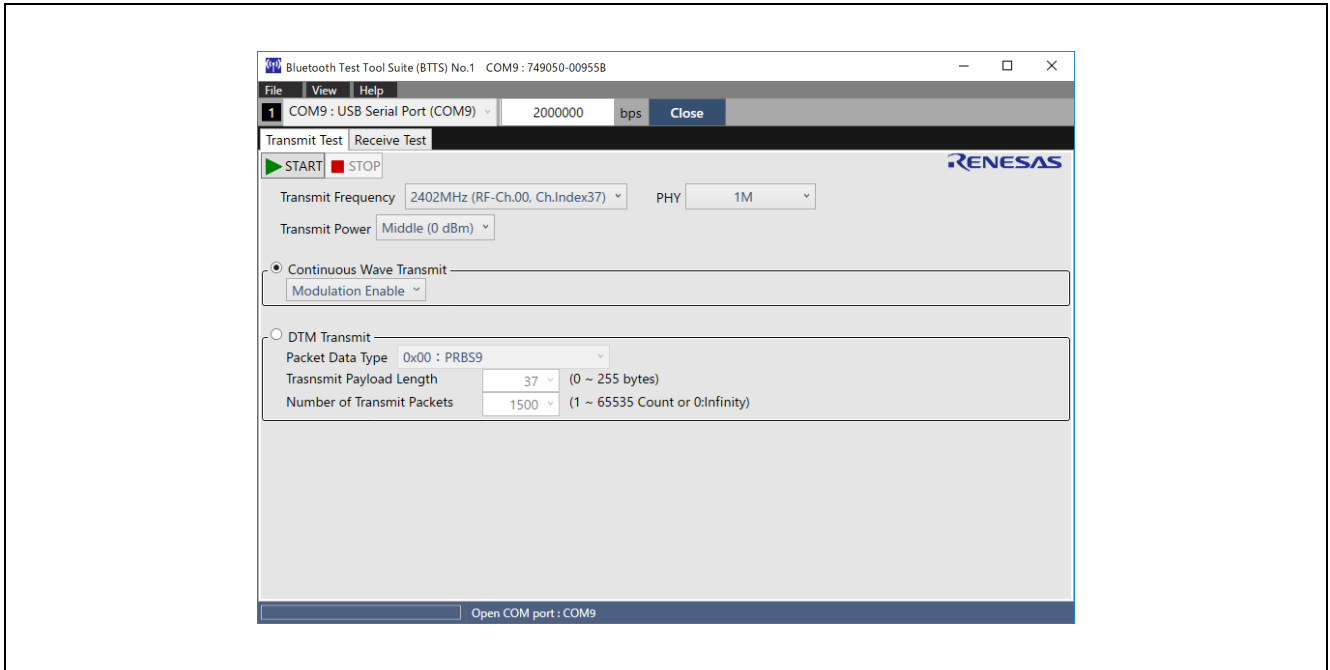

Figure 5-1. RF Evaluation tool

To transmit Continuous Wave data, click "Transmit Test" on the top tab and select the "Continuous Wave Transmit" radio button.

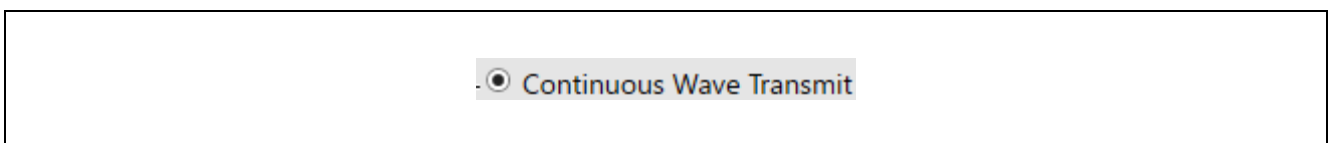

Figure 5-2. Continuous Wave transmission selection

The related setting items are as follows.

- Transmission Wave
- Transmit frequency channel
- Transmit power

5.1.1 Transmission Wave

Select a transmission wave from the pull-down menu under the "Continuous Wave Transmit" radio button.

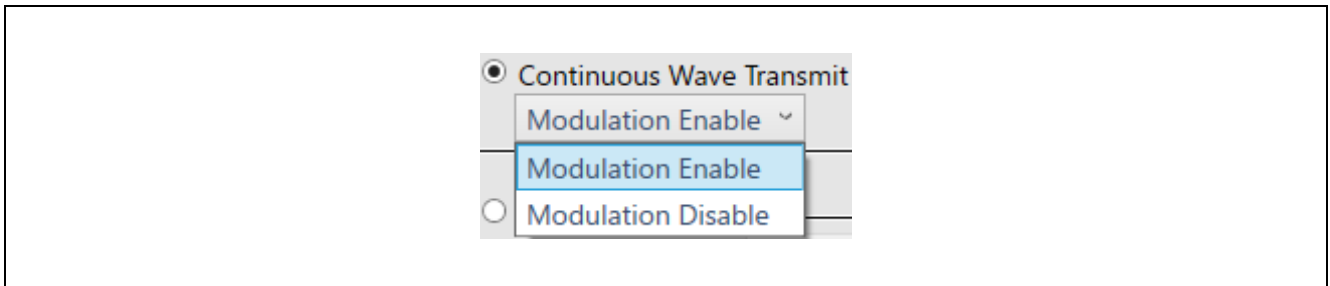

Figure 5-3. Continuous Wave waveform selection

- Modulation Enable
The modulation wave will be selected.
- Modulation Disable
The non-modulation wave will be selected.

5.1.2 Transmit frequency channel

Select the transmission frequency channel from the "Transmit Frequency" pull-down menu. Channels 0 to 39 can be selected in units of 2MHz.

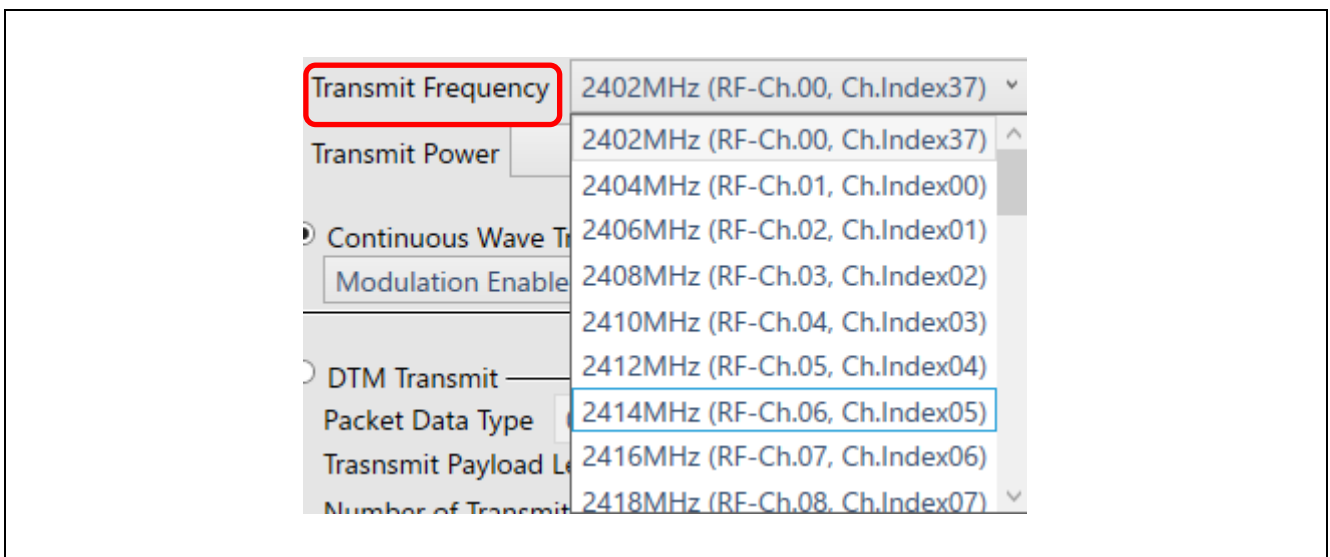

Figure 5-4. Transmit Frequency channel selection

5.1.3 Transmit power

Select the transmission power from the "Transmit Power" pull-down menu. Three stages of Low / Middle / High settings available.

Note: The transmission power (dBm) corresponding to each stage depends on the MCU firmware configuration.

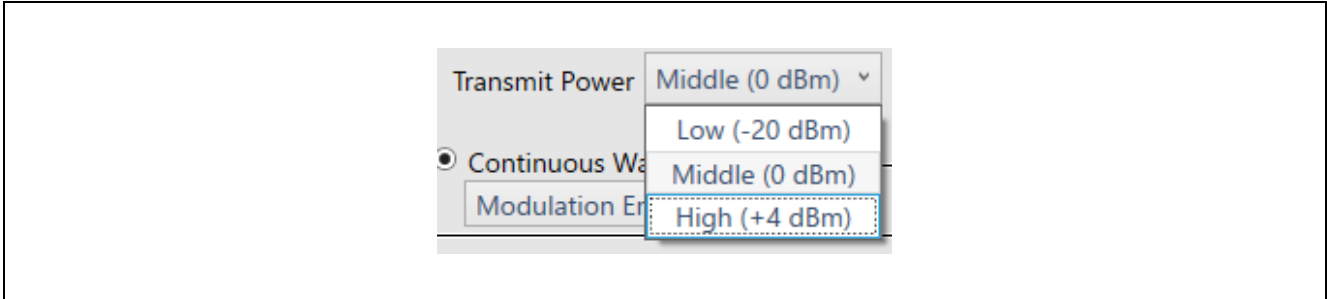

Figure 5-5. Transmit Power selection

5.1.4 Transmission Start / Stop

Click the "▶START" button to start the transmission, so measure the waveform with Instruments such as spectrum analyzers.

Click the "■STOP" button to stop the transmission.

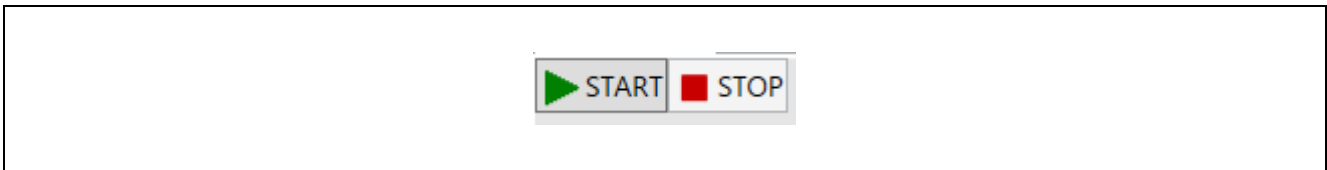

Figure 5-6. Transmit START / STOP button

5.2 Evaluate with Direct Test Mode

The Bluetooth specification specifies the Direct Test Mode (hereinafter DTM) as a test mode for testing RF. When conducting the Radio Law certification test, the device needs to be DTM.

This chapter describes procedure to perform RF evaluation using DTM with two MCU units.

Select "RF Evaluation" in the tool launcher to start the RF evaluation tool. Connect the EVB according to the procedure described in 3.3.

The transmit side selects the "DTM Transmit" radio button on the "Transmit Test" tab.

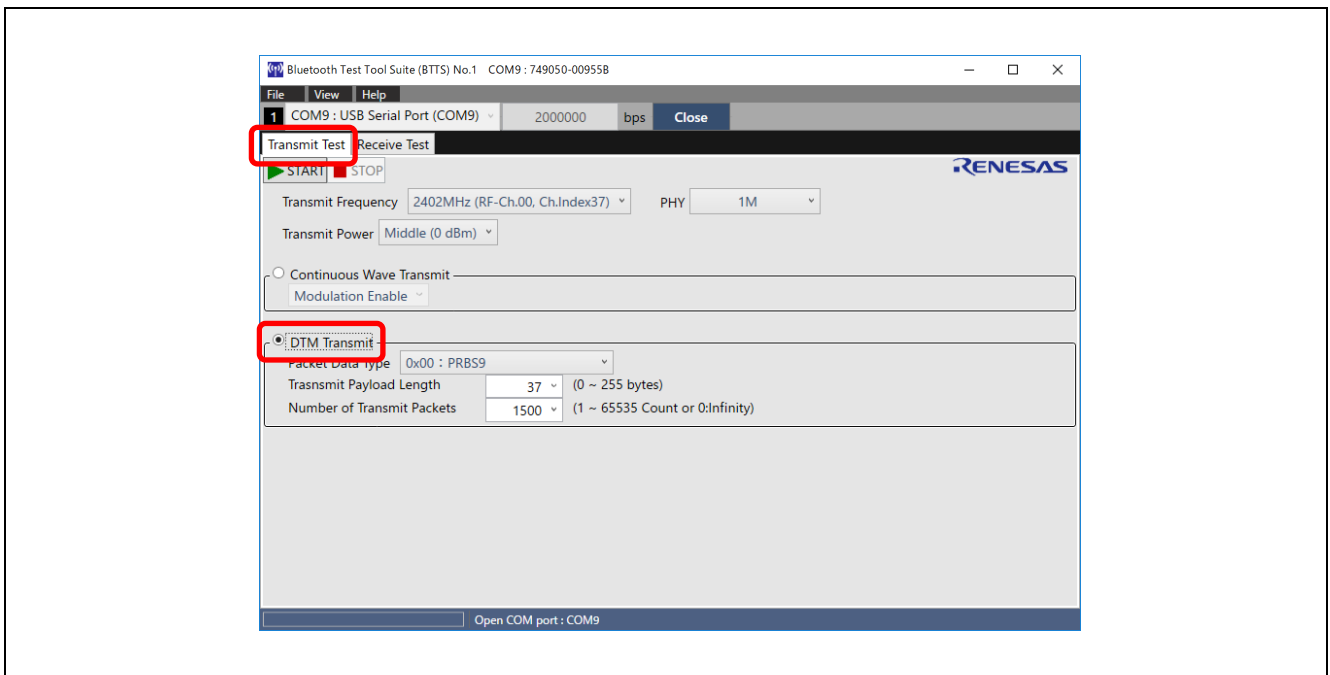

Figure 5-7. "DTM transmit" selection on "Transmit Test" tab

The related setting items of the transmit side are as follows.

- Transmission packet type
- Transmission payload
- Packet transmission count
- Transmission frequency channel
- Transmission PHY
- Transmission Power

On the receive side, select "RF Evaluation" in the tool launcher as well as on the transmit side to start the RF Evaluation tool. Connect the EVB according to the procedure described in 3.3.

After connecting, select the "Receive Test" tab.

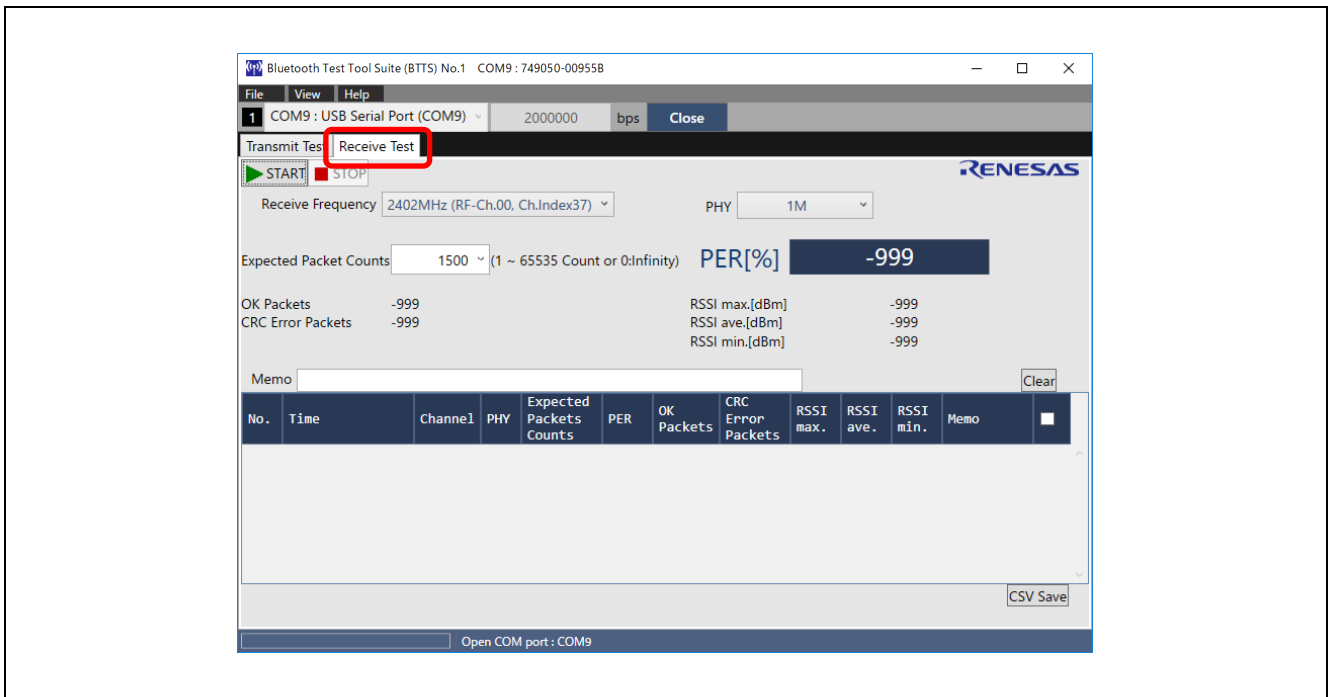

Figure 5-8. "Receive Test" tab

The related setting items on the receive side are as follows.

- Receive frequency channel
- Receive PHY
- Number of received packets

5.2.1 DTM transmit / receive operation

<Transmit side / Receive side> The transmit side uses "Transmit Frequency" and the receive side uses "Receive Frequency" pull-down menu to select the frequency channel. Select the same channel on the transmit side and receive side.

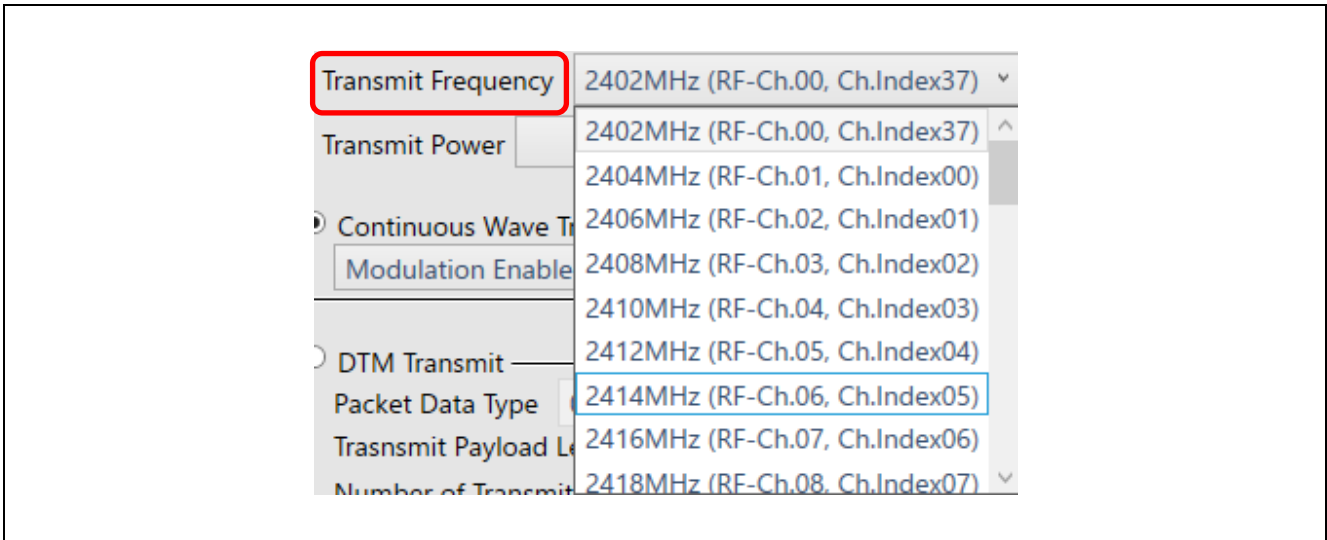

Figure 5-9. Frequency channel selection

<Transmit side / Receive side> Select the PHY to use from the PHY pull-down menu. Select the same PHY on the transmit side and receive side.

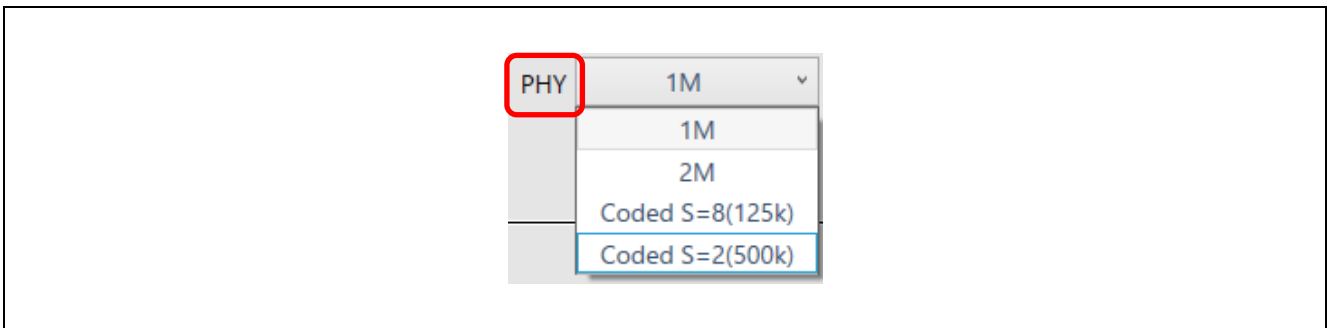

Figure 5-10. PHY selection

<Transmit side> Select the transmit power level from the "Transmit Power" pull-down menu.

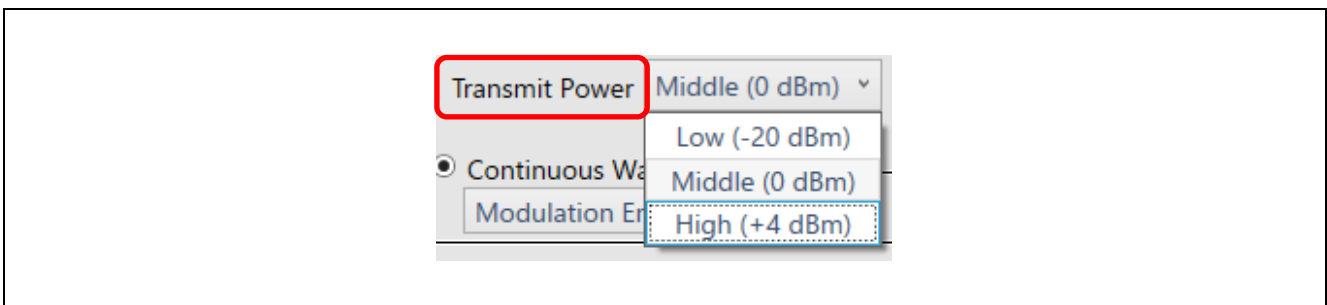

Figure 5-11. Transmit Power selection

<Transmit side> Select the data type of the transmit packet from the "Packet Data Type" pull-down menu under the "DTM Transmit" radio button.

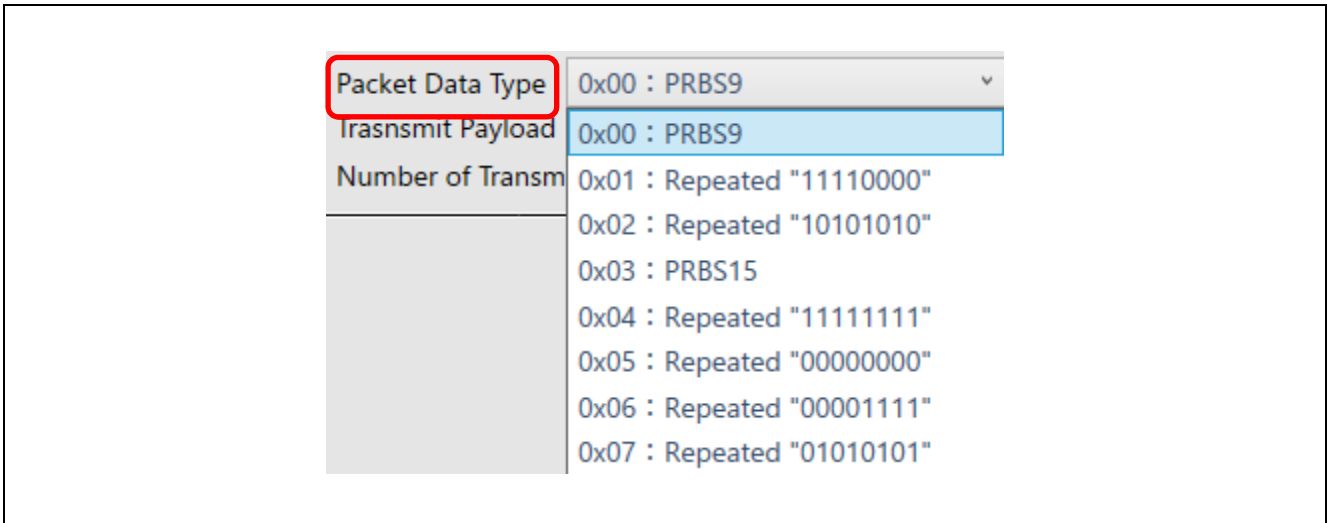

Figure 5-12. Packet Data Type selection

<Transmit side> Select the transmit payload length from the "Transmit Payload Length" pull-down menu. You can also enter a value between 0 and 255 directly.

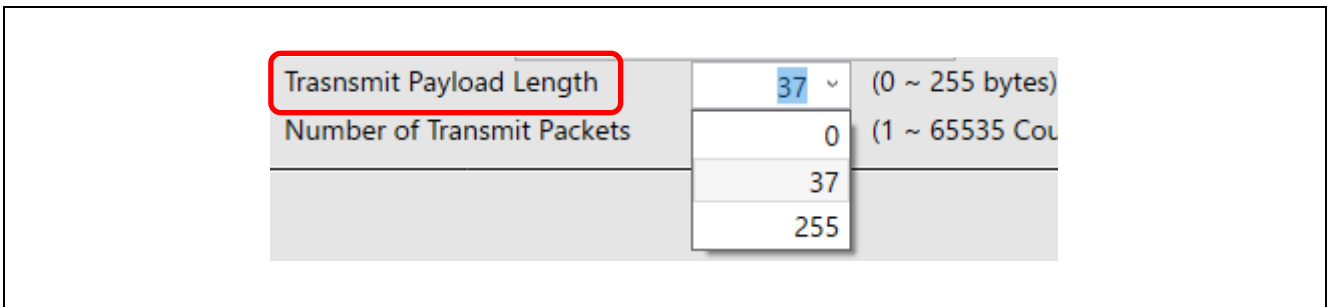

Figure 5-13. Transmit Payload Length setting

<Transmit side> Select the number of transmitted packets from the "Number of Transmit Packet" pull-down menu. You can also enter a value between 0 and 65535 directly. When 0 is set, it will be "infinite transmission".

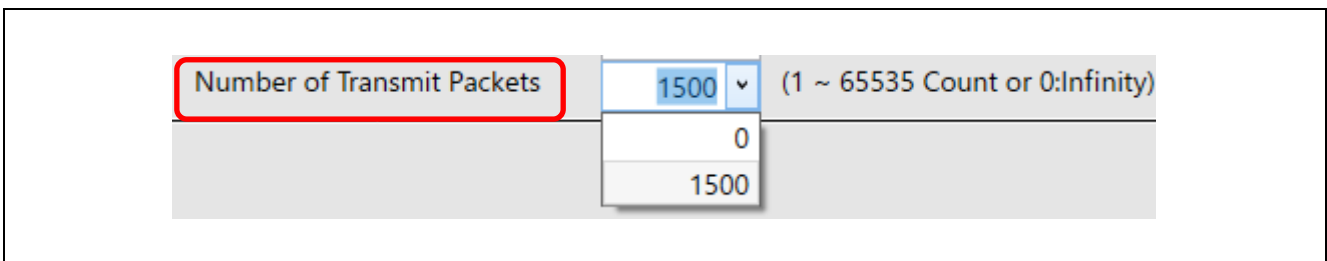

Figure 5-14. Number of Transmit Packets setting

<Receive side> Select the number of received packets from the "Expected Packet Counts" pull-down menu. You can also enter a value between 0 and 65535 directly. When 0 is set, it will be "infinite reception".

Note: Set the same value as the setting in "Number of Transmit Packet" on the transmit side.

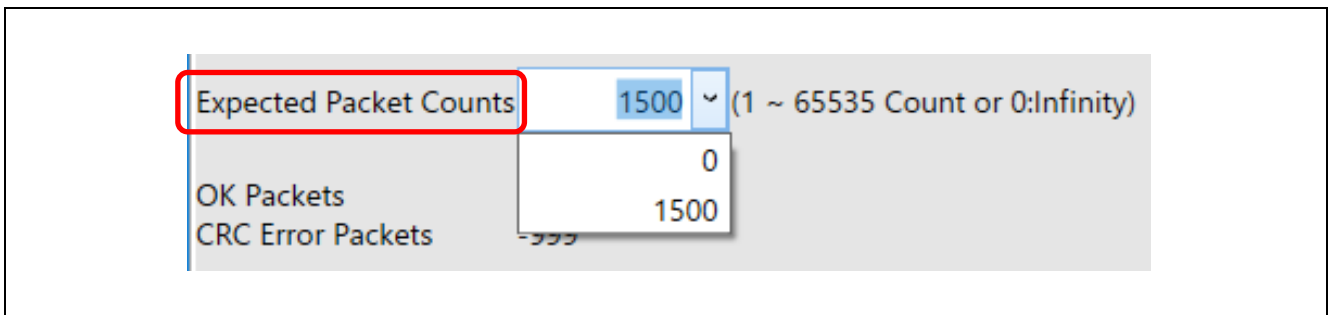

Figure 5-15. Expected Receive Packet Counts setting

<Transmit side / Receive side> Starts data transmission and reception of DTM. Start and stop are performed with the "▶START" and "■STOP" buttons at the top of each window tab.

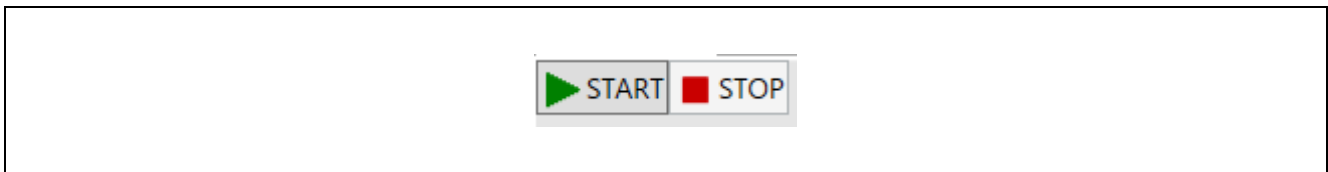

Figure 5-16. DTM data transmission and reception START/ STOP button

First, click the receive side's "▶START" button to start receiving DTM data. Then, click the transmit side's "▶START" button to start transmission DTM data.

The transmit side transmits packets the number of times specified in "Number of Transmit Packet" and stops automatically. If "Infinite transmission" is specified, click the "■STOP" button to stop manually.

After stopping packets transmission on the transmit side, click the "■STOP" button on the receive side to stop receiving.

Note: The correct result can not be obtained if you start transmission first.

5.2.2 DTM reception result display

When the receive side clicks the "■STOP" button, the reception result is displayed.

"PER (Packet Error Rate)" is calculated using the value set in "Expected Packet Counts" and the value of the reception result "OK Packets". The result is displayed to the second decimal places.

Note: When the value of "Expected Packet Counts" is 0, "-999" indicating invalid is displayed in "PER".
 When the both values of "OK Packets" and "CRC Error Packets" are 0, "-999" indicating invalid is displayed in "RSSI (Received Signal Strength Indicator) max", "RSSI ave" And "RSSI min".

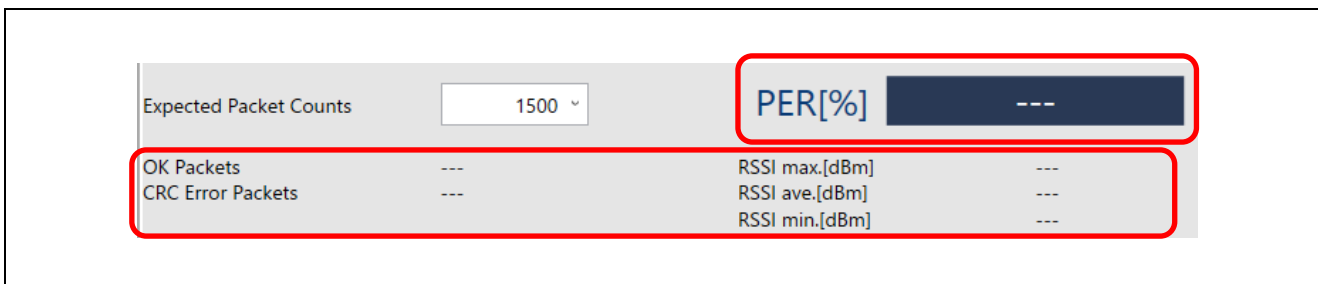

Figure 5-17. Measurement result display part

Also, every time measurement is completed by clicking the "■STOP" button, measurement result records are added to the data grid at the bottom of the window.

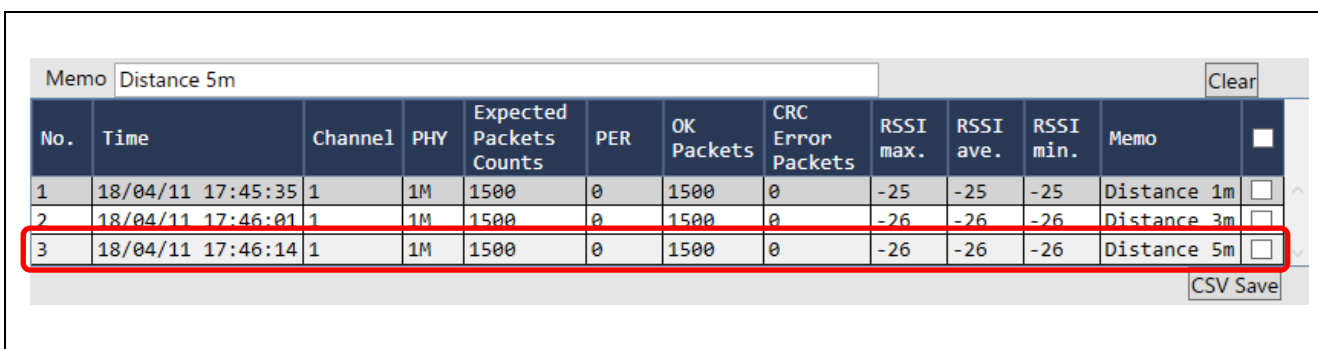

Figure 5-18. Measurement result history display part

The "Memo" text field at the top of the data grid can enter notes to accompany the results. The text entered will be reflected in the "Memo" column of the measurement result record when the "■STOP" button is clicked.

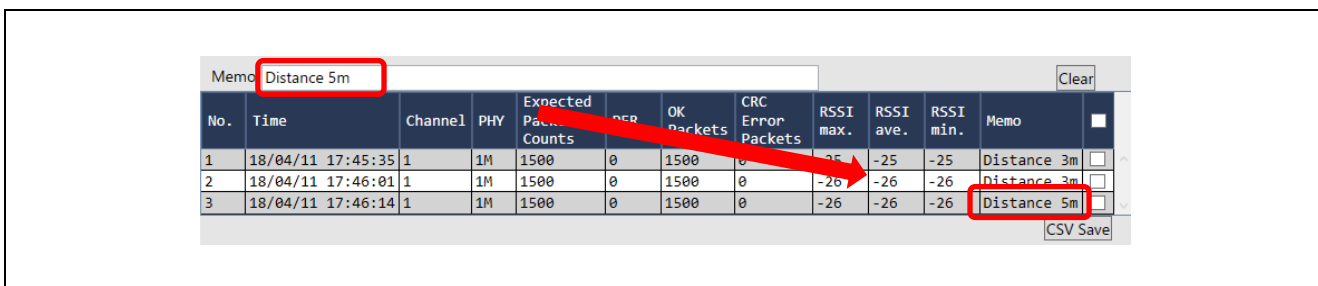

Figure 5-19. Setting of accompanying memo to result records

Click the "Clear" button at the top of the data grid to delete the records selected by the check box at the right end of the data grid. Operating the check box in the data grid header row will select / deselect all records.

When you click the "CSV Save" button at the bottom of the data grid, the measurement result history displayed in the data grid is saved to a file in CSV format.

6. Evaluate the Beacon function

This chapter describes the Beacon tool using the MCU.

6.1 Transmit Beacon data

Select "Beacon Advertising" in the tool launcher to start the Beacon Advertising tool. Connect the EVB according to the procedure described in 3.3.

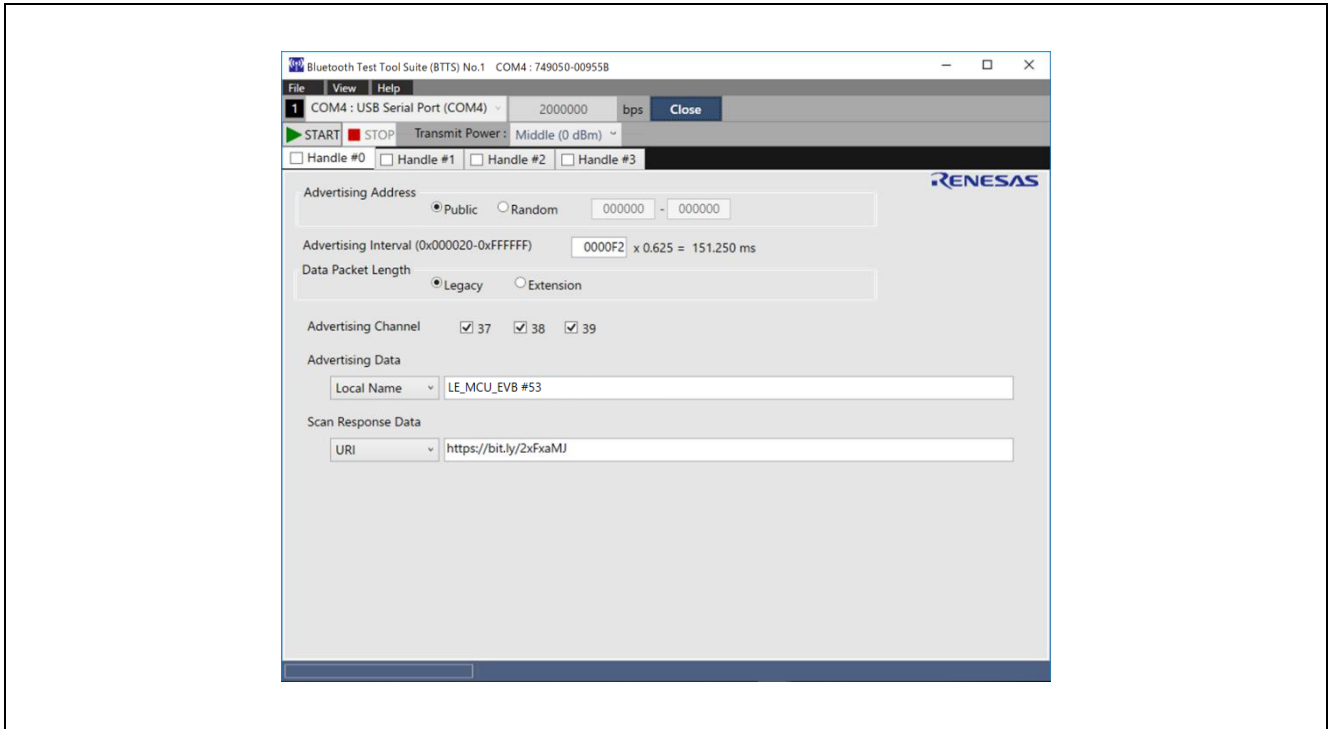

Figure 6-1. Beacon Advertising tool operation screen

6.1.1 Advertising handle

MCU can set up to 4 advertising handles. The display of each handle is switched on the tab of the Beacon Advertising tool operation screen. Use the check box to enable / disable the handle. If the check box is ON () , the handle is valid. If the check box is OFF () , the handle is invalid and advertising is not executed even if advertisement data is set.

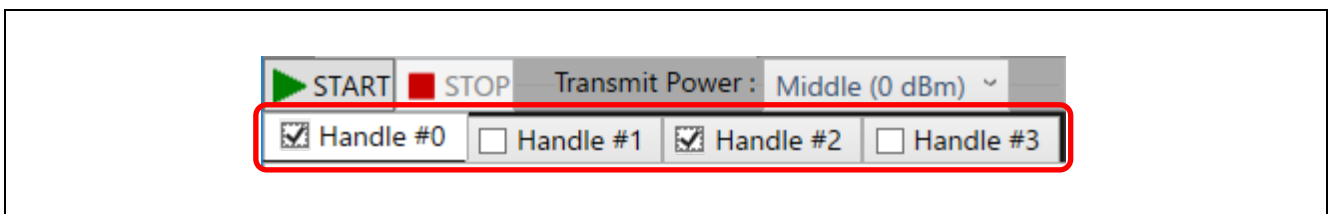

Figure 6-2. Advertising handle switching tab

6.1.2 Advertising transmit power

Set transmit power of the advertiser.

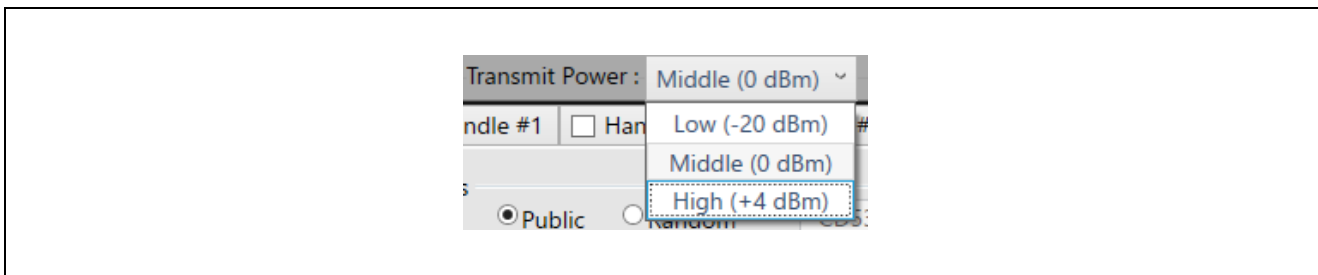

Figure 6-3. Advertising transmit power setting

6.1.3 Legacy / Extension Advertising switching

Switch between "Legacy" advertising (packet's payload size up to 31 octets) and "Extension" advertising (packet's payload size up to 255 octets) with the "Data Packet Length" radio button in the handle tab. The display switches to the selected advertising setting screen.

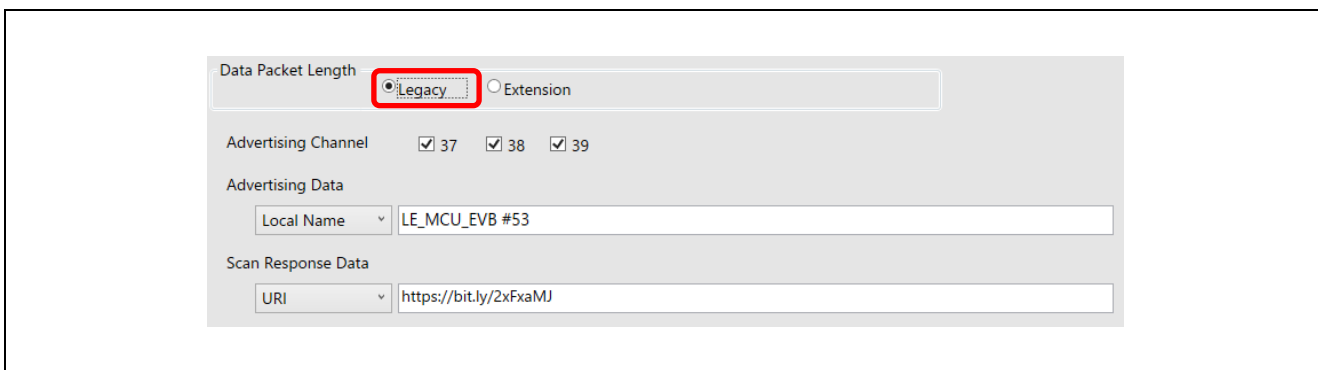

Figure 6-4. Legacy advertising setting screen

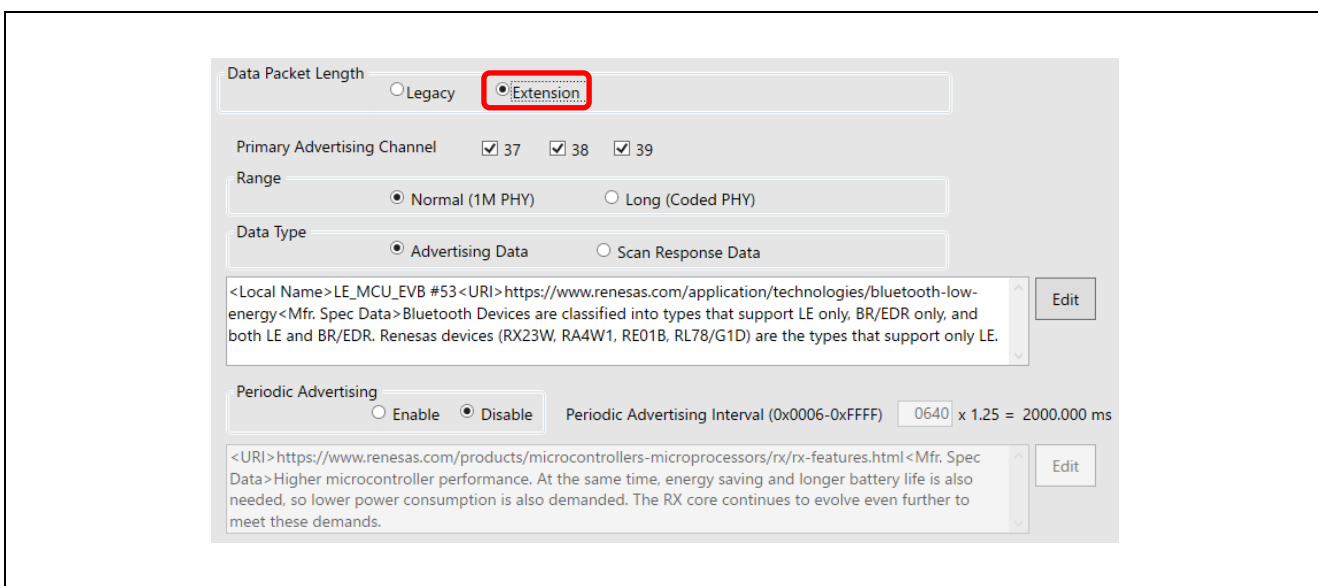

Figure 6-5. Extension advertising setting screen

6.1.4 Legacy / Extension Advertising Common Settings

The setting items common to Legacy Advertising and Extension Advertising are as follows.

- Advertising address type
- Advertising interval

In the advertising address type setting, select the address (public address that is a device-specific physical address or a fixed random (static) address for each device generated from the MCU's unique ID) to be used for advertising. The random address is automatically set in the text box when connecting to the EVB. If the public address is invalid, the "Public" radio button cannot be selected.

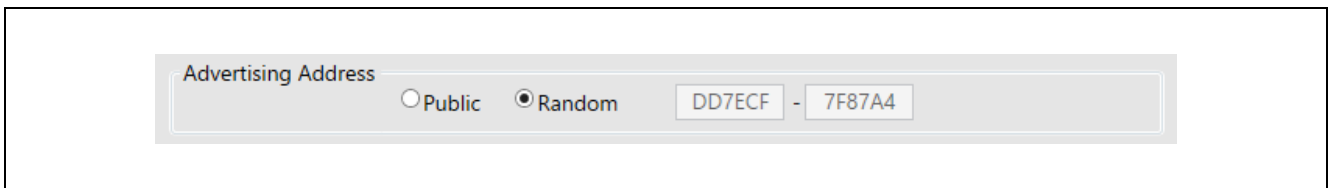

Figure 6-6. Advertising address type setting

Set the advertising interval in hexadecimal according to the Bluetooth specification. The values that can be set are from 0x20 to 0xFFFFFFFF, and the value multiplied by 0.625ms is the actual interval value.

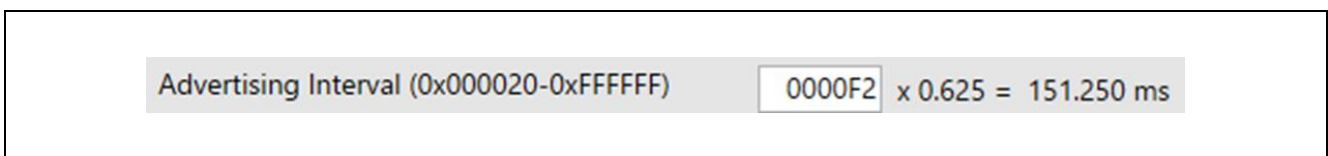

Figure 6-7. Advertising interval setting

6.1.5 Legacy Advertising Settings

The setting items related to Legacy Advertising are as follows.

- Advertising channel
- Advertising data
- Scan response data

Select the channel to use for Legacy Advertising using the checkbox.

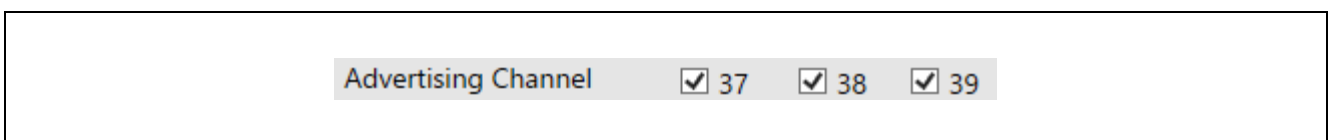

Figure 6-8. Legacy Advertising channel settings

Set the "Advertising Data" and the "Scan Response Data". "Advertising Data" is advertisement data actively sent by the advertiser, and "Scan Response Data" is advertisement data passively sent in response to a request from the scanner.

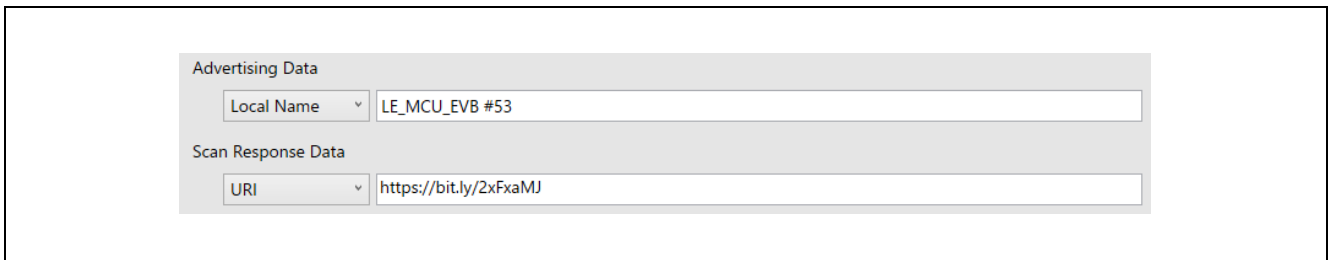

Figure 6-9. Advertising Data and Scan Response Data settings

Select the type of Advertising Data (AD) to be sent from the pull-down menu on the left side of the Advertising Data and Scan Response Data settings.

The three AD types that can be selected with this tool are "Local Name", "URI", and "Mfr. Spec Data". (For other AD types, see "Assigned Numbers / Generic Access Profile" on the Bluetooth SIG website). Set the AD data corresponding to the AD type in the text box on the right side of the pull-down menu. If AD data is empty, advertising is not performed. If the AD data of the scan response data is empty, it will not respond to the scan request. The maximum length of AD data is 29 octets.

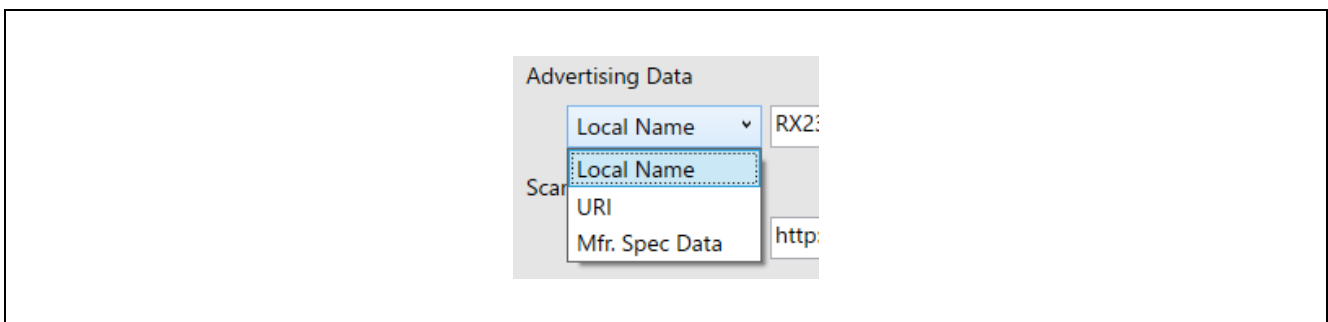

Figure 6-10. Advertising Data type selection

6.1.6 Extension Advertising Settings

The setting items related to Extension Advertising are as follows.

- Primary Advertising Channel
- Range
- Advertisement data
- Periodic Advertising settings

Select the primary channel to be used for extension advertising using the check box.



Figure 6-11. Extension Primary Advertising Channel settings

Select "Normal (1M PHY)" or "Long (Coded PHY)" with the "Range" radio button for the communication range of extension advertising. Coded's coding scheme uses the default S = 8, 125kb/s. (The default setting can be changed using the API of the Bluetooth protocol stack, but this tool does not use it. Also for legacy, Normal (1M PHY) is used.)

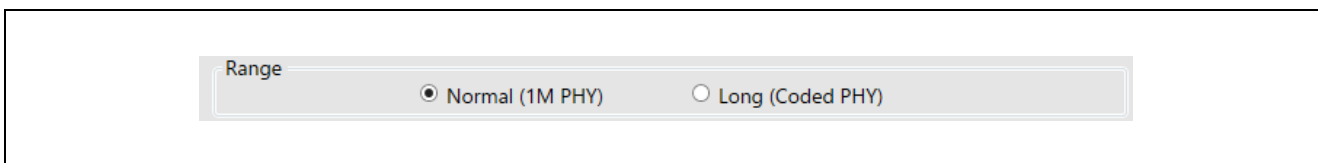

Figure 6-12. Setting the communication range

Use the "Data Type" radio button to set the method of sending the advertising data for extension advertising. Select "Advertising Data" or "Scan Response Data" to specify whether to send advertisement data actively at the interval of the advertising interval or passively in response to a request from the scanner.

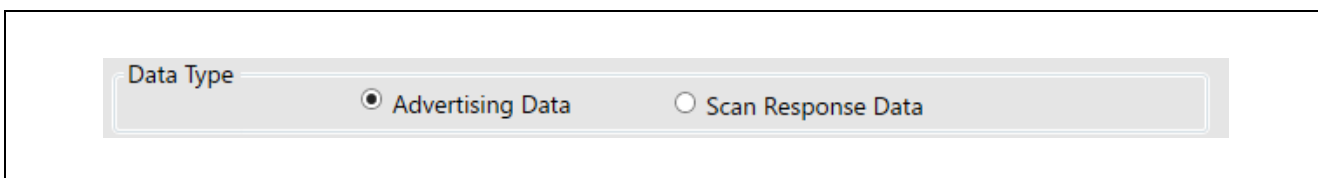

Figure 6-13. Selecting extension advertising data types

Advertisement data for extension advertising specified in the text box can be edited in the "Multi AD Structure Editor" window displayed by clicking the "Edit" button in Figure 6-15. Specify the AD type from the pull-down menu on the left, and enter the AD data corresponding to that type in the text box on the right. Up to 3 AD structures can be set, and the length of AD data that can be set in each AD structure is a maximum of 254 octets. Use the "+" and "-" buttons on the right side of the text box to add or delete AD structures.

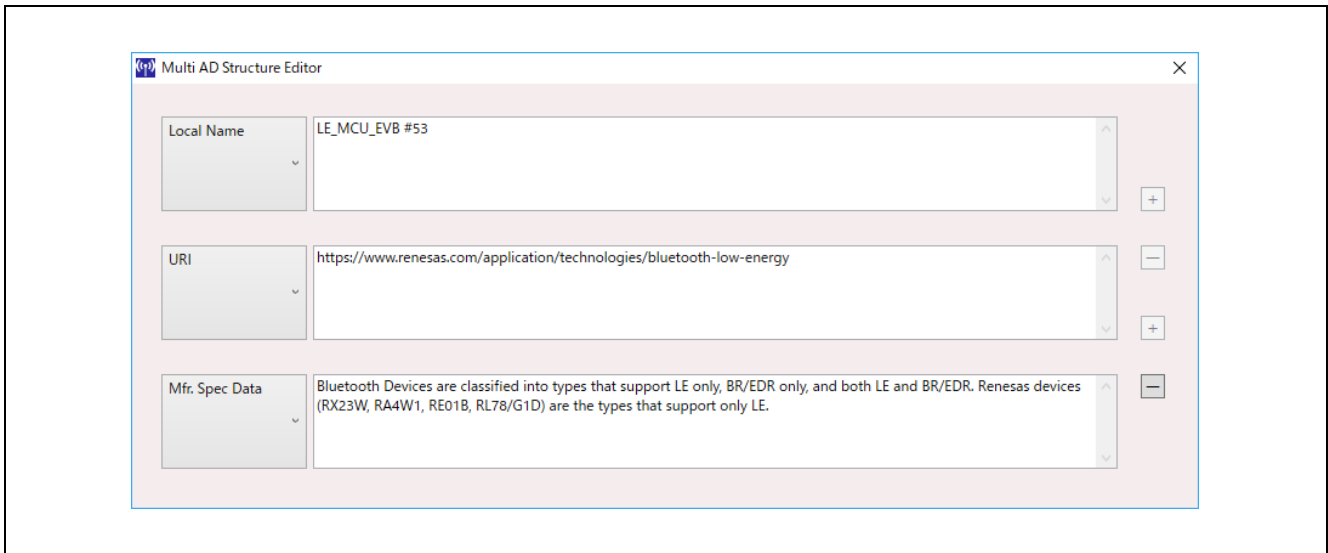

Figure 6-14. Multi AD Structure Editor window

The edited data is displayed continuously in the advertisement data display text box in the AD Structure (<AD Type> AD Data) format.

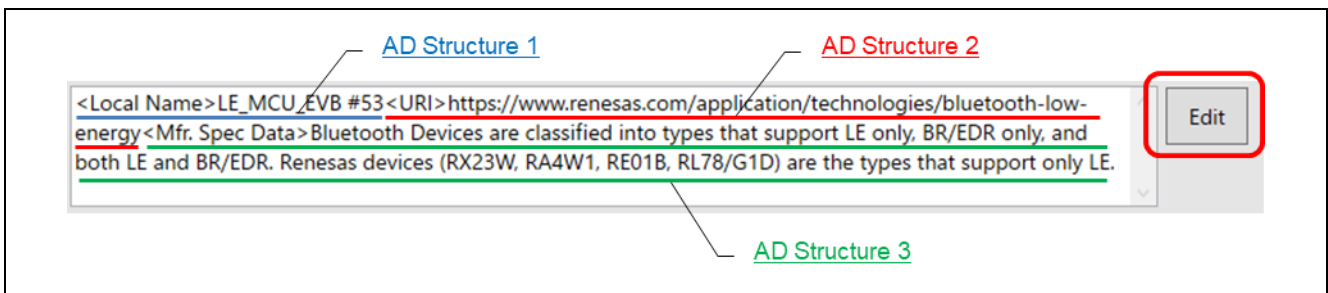

Figure 6-15. Advertisement data display text box

Set items related to the Period Advertising is as follows.

- Periodic Advertising enable / disable specified
- Periodic Advertising interval
- Advertisement data for Periodic Advertising

To perform periodic advertising, set the "Periodic Advertising" radio button to "Enable". When "Disable" is selected, periodic advertising is not performed.



Figure 6-16. Periodic Advertising settings

When performing periodic advertising, set the interval value for periodic advertising.



Periodic Advertising Interval (0x0006-0xFFFF) 00FF x 1.25 = 318.750 ms

Figure 6-17. Periodic Advertising Interval setting

The advertisement data for periodic advertising can be edited in the "Multi AD Structure Editor" window in the same way as the advertisement data for extension advertising.

6.1.7 Advertising start / stop

Click the "▶START" button to start advertising. Click "■STOP" to stop. Advertising operations and advertisement data can be confirmed on the scanner side (EVB or smartphone).



Figure 6-18. Advertising start / stop button

6.1.8 Saving advertising handle properties

Beacon Advertising Tool saves properties data of four advertising handles separately from properties saving of tool common (see "3.4 Termination of Tool and Tool Launcher") when the tool terminate.

Save as text data in "beacon_adv_properties.dat" in the same folder as the exe file. The next time the tool is started, the automatically saved data is loaded from "beacon_adv_properties.dat" and the previous properties are restored.

6.2 Receive Beacon data

Select "Beacon Scanning" in the tool launcher to start the beacon scanning tool. Connect the EVB according to the procedure described in 3.3.

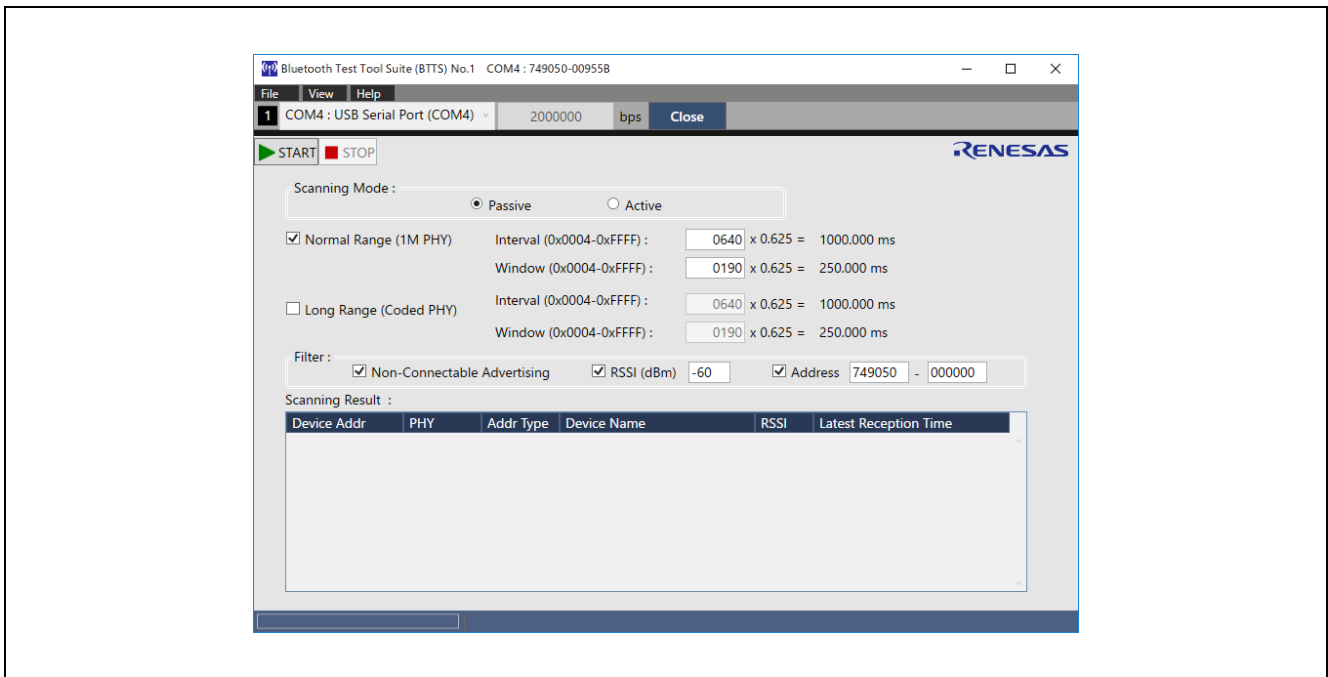

Figure 6-19. Beacon Scanning tool operation screen

6.2.1 Scanning mode

Use the "Scanning Mode" radio button to specify the scanning mode setting. In the case of "Passive", advertisement data actively transmit by the advertiser is acquired, and in the case of "Active", advertisement data (scan response data) passively transmit by the advertiser is acquired in response to a request from the scanner side.

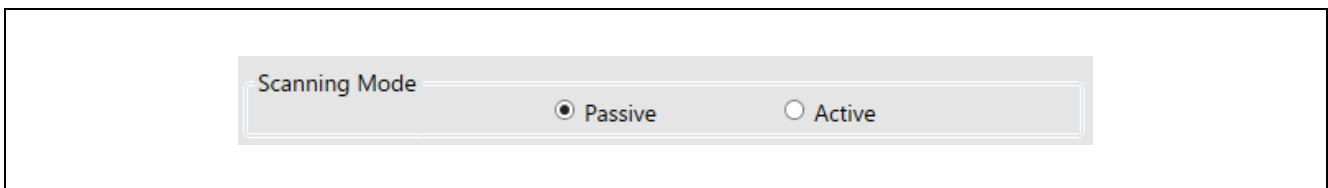

Figure 6-20. Scanning Mode selection

6.2.2 PHY and Scanning operation settings

Set the PHY to be used according to the range to be scanned. "Normal Range (1M PHY)" and "Long Range (Coded PHY)" can be selected. It is also possible to select both PHYs. Coded's coding scheme uses the default S=8, 125kb/s. (The default settings can be changed using the Bluetooth protocol stack API, but are not used in this tool.)

Set the scanning operation of the PHY to be used in the scan interval and scan window. The hexadecimal value entered in the text box is converted to millisecond units and displayed on the right side of the text box.

Note: If both PHYs are selected, the total scan duty cycle must be set to 100% or less. Set so that the following formula is satisfied.

$$1M \text{ Window} / 1M \text{ Interval} + \text{Coded Window} / \text{Coded Interval} \leq 1$$

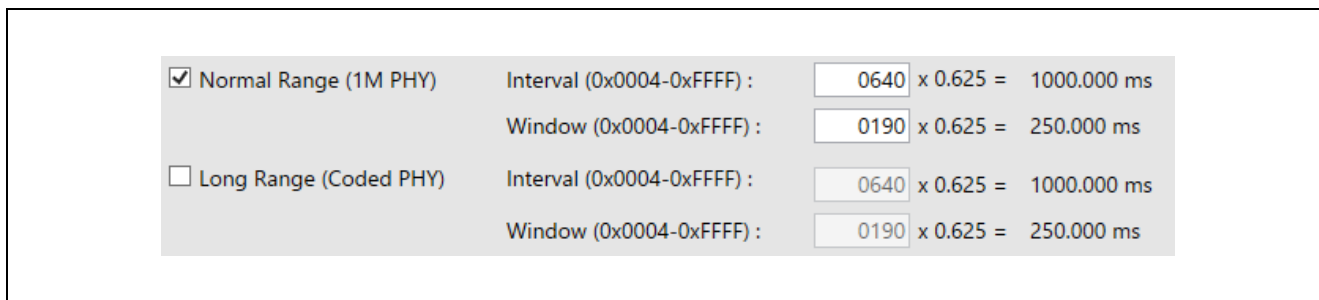

Figure 6-21. Scanning PHY selection and scanning operation settings

6.2.3 Filter settings

If there are many advertisers in the surrounding area, setting a filter makes it easier to detect the target device.

- When "Non-Connectable Advertising Filter" is checked, only devices that cannot be connected will be displayed in the scanning result list.
- When "RSSI (dBm) Filter" is checked, only devices with RSSI values greater than or equal to the value entered in the text box (setting range: -127 to 20) are displayed in the scanning result list.
- When "Address Filter" is checked, the filter with BD address is enabled. If the value of the vendor management field (right side of the text box) is "000000", only devices with addresses that match the Organizationally Unique Identifier (OUI) field (left side of the text box) are displayed in the scanning result list. If the value of the Vendor management field is other than "000000", the specified address is registered in the "White List", and only devices whose addresses completely match are displayed in the list.

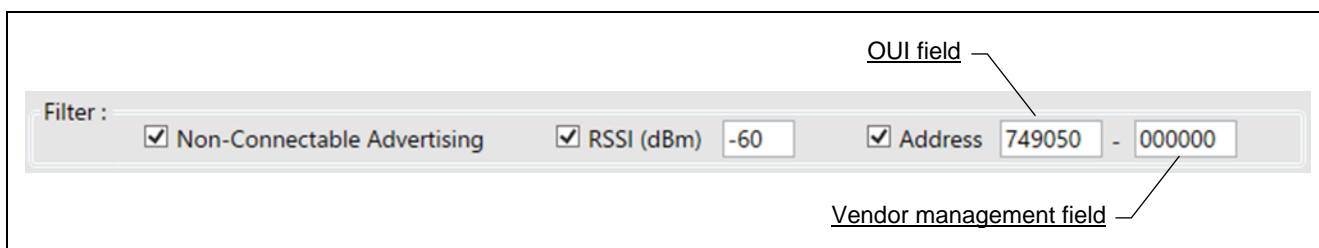

Figure 6-22. Filter settings

6.2.4 Scanning start / stop

Click the "▶START" button to start scanning. Click "■STOP" to stop.



Figure 6-23. Scanning start / stop button

When scanning starts, a list of detected advertisers is displayed in the "Scanning Result" table. To display the advertisement data, double-click the device to be displayed to open the advertisement data display window.

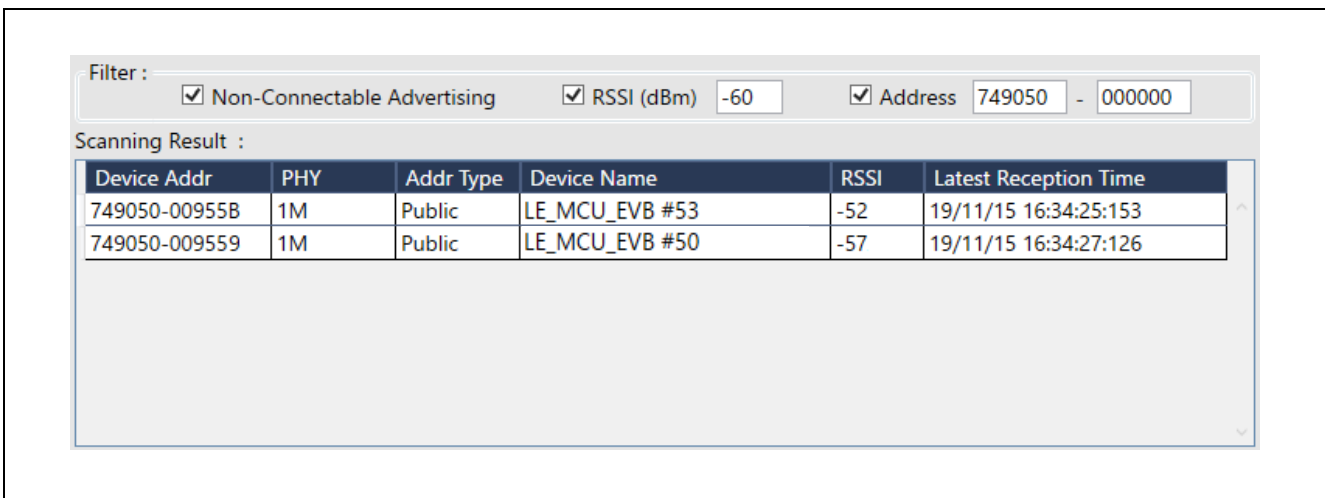
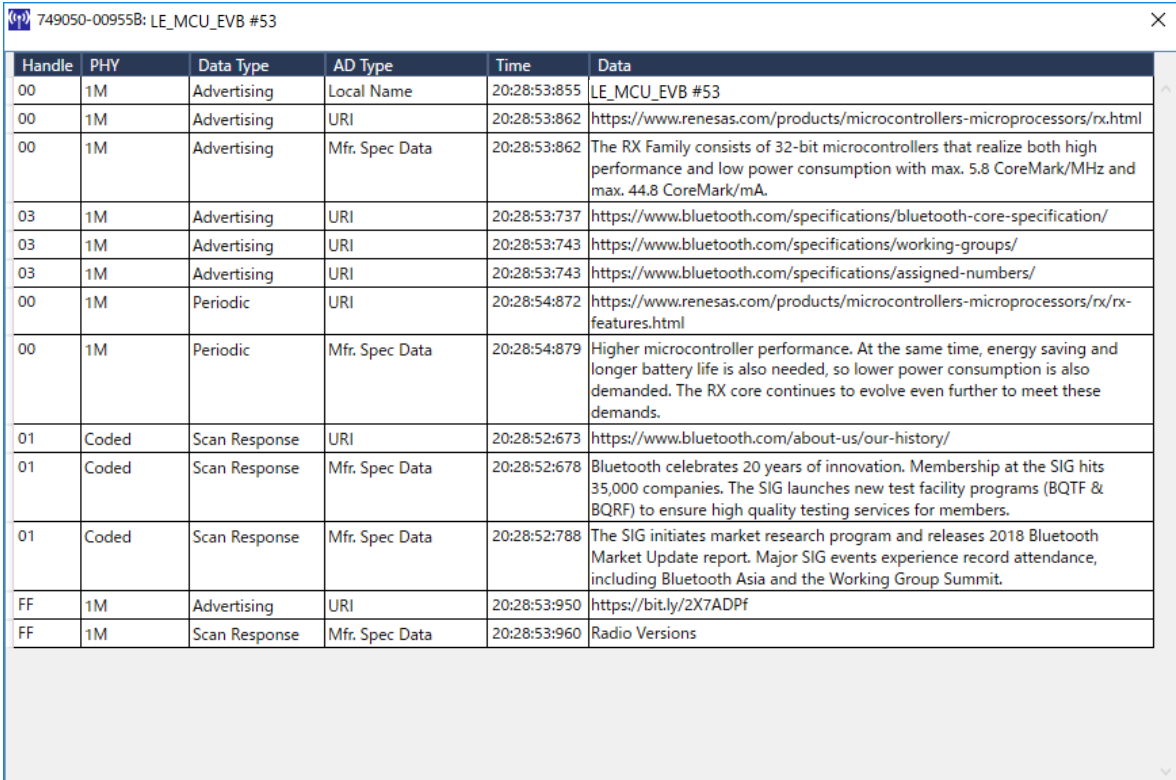

Figure 6-24. Scanning result display

6.2.5 Display of Advertisement Data

The advertisement data (advertising report) of the selected device is displayed in the advertisement data display window.



Handle	PHY	Data Type	AD Type	Time	Data
00	1M	Advertising	Local Name	20:28:53:855	LE_MCU_EVB #53
00	1M	Advertising	URI	20:28:53:862	https://www.renesas.com/products/microcontrollers-microprocessors/rx.html
00	1M	Advertising	Mfr. Spec Data	20:28:53:862	The RX Family consists of 32-bit microcontrollers that realize both high performance and low power consumption with max. 5.8 CoreMark/MHz and max. 44.8 CoreMark/mA.
03	1M	Advertising	URI	20:28:53:737	https://www.bluetooth.com/specifications/bluetooth-core-specification/
03	1M	Advertising	URI	20:28:53:743	https://www.bluetooth.com/specifications/working-groups/
03	1M	Advertising	URI	20:28:53:743	https://www.bluetooth.com/specifications/assigned-numbers/
00	1M	Periodic	URI	20:28:54:872	https://www.renesas.com/products/microcontrollers-microprocessors/rx/rx-features.html
00	1M	Periodic	Mfr. Spec Data	20:28:54:879	Higher microcontroller performance. At the same time, energy saving and longer battery life is also needed, so lower power consumption is also demanded. The RX core continues to evolve even further to meet these demands.
01	Coded	Scan Response	URI	20:28:52:673	https://www.bluetooth.com/about-us/our-history/
01	Coded	Scan Response	Mfr. Spec Data	20:28:52:678	Bluetooth celebrates 20 years of innovation. Membership at the SIG hits 35,000 companies. The SIG launches new test facility programs (BQTF & BQRF) to ensure high quality testing services for members.
01	Coded	Scan Response	Mfr. Spec Data	20:28:52:788	The SIG initiates market research program and releases 2018 Bluetooth Market Update report. Major SIG events experience record attendance, including Bluetooth Asia and the Working Group Summit.
FF	1M	Advertising	URI	20:28:53:950	https://bit.ly/2X7ADPf
FF	1M	Scan Response	Mfr. Spec Data	20:28:53:960	Radio Versions

Figure 6-25. Advertisement data display window

Advertisement data is list displayed in AD Structure units. The display items in each list are as follows.

- **Handle**
In the case of Extension Advertising data, the handle number ("00" to "03") is displayed. For Legacy Advertising, "FF" is displayed.
- **PHY**
Displays the information "1M" / "Coded" of the PHY that received the data.
- **Data Type**
The advertisement data actively transmit by the advertiser is displayed as "Advertising", the data passively transmit by the advertiser in response to a request from the scanner side is displayed as "Scan Response", and the data transmit with periodic advertising is displayed as "Periodic".
- **AD Type**
Displays the advertising data type. In this tool, "Local Name" / "URI" / "Mfr. Spec Data" is displayed.
- **Time**
Displays the reception time in milliseconds unit.
- **Data**
Displays AD Data. Only Ascii code can be displayed.

7. Evaluate Data Communication functions

This chapter describes the connection and the data communication functions using MCU.

7.1 Service definition

The Data Communication tool measure throughput by performing data communication using a unique "Throughput Service". "Throughput Service" is defined on the server (The Data Communication Slave tool) side as follows.

CUSTOM SERVICE

UUID: 9CEF3D10-7FAB-49DC-AB89-762C9079FE96

Name: Renesas Throughput Service

PRIMARY SERVICE

CUSTOM CHARACTERISTIC

UUID: 9CEF3D11-7FAB-49DC-AB89-762C9079FE96

Name: Throughput Data 1 Characteristic

Properties: Write / Write Without Response

CUSTOM CHARACTERISTIC

UUID: 9CEF3D12-7FAB-49DC-AB89-762C9079FE96

Name: Throughput Data 2 Characteristic

Properties: Indicate / Notify

Descriptors:

Client Characteristic Configuration

UUID: 0x2920

Note: The client (Data Communication Master tool) discovers for services after connecting to the server device. As a result, the Data Communication Window switches to the Throughput Measurement Window only when "Throughput Service" is found.

7.2 Measure the throughput with the smartphone as the opposing device

This chapter describes the procedure for data communication with a Bluetooth 5 compatible smartphone using the MCU.

Select "Data Comm Slave" in the tool launcher to start the data communication slave tool. Connect the EVB according to the procedure described in 3.3.

Note: When starting throughput measurement, recommend that turn off the API / Event log output function described in 4.2.1 to reduce the processing load on the tool.

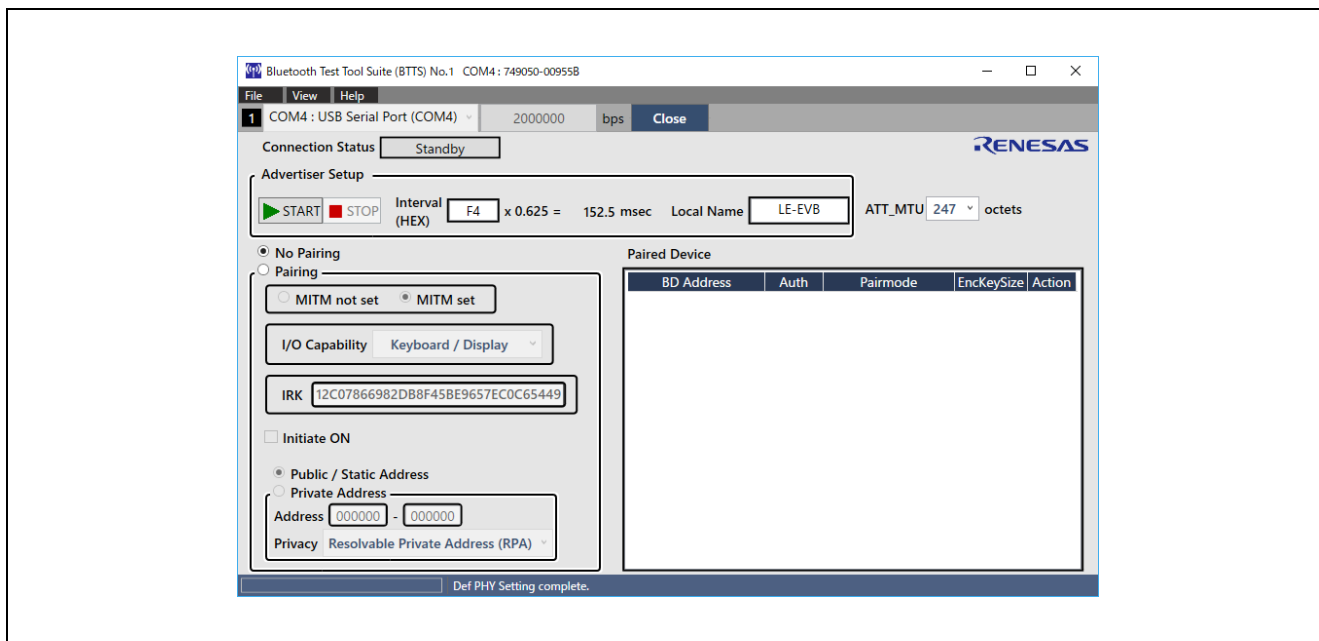

Figure 7-1. Data communication window (slave)

7.2.1 Advertising start (MCU side)

First, make settings for advertising from MCU. Setup the "Interval (HEX)" and the "Local Name" in the "Advertiser Setup" frame.

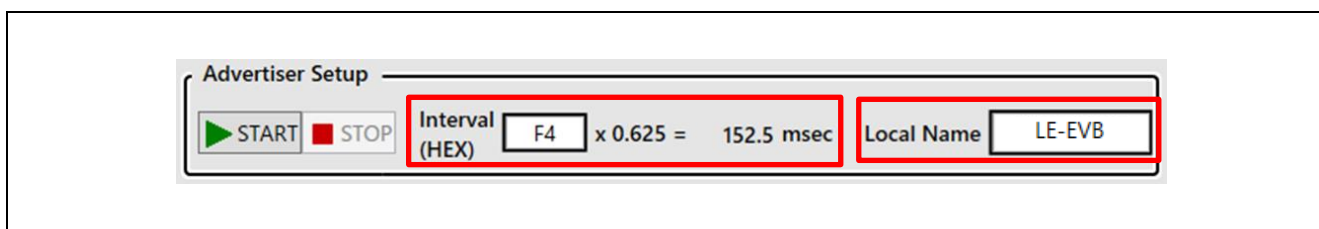

Figure 7-2. Advertising setting display

Enter the advertising interval value in the "Interval (HEX)" text box. Input in hexadecimal. As you type, the actual set value is calculated and displayed in decimal on the right side of the text box. The input range is 0x20 to 0x4000. If the set interval is long, it may take time to detect EVB in the smartphone scanning operation.

Set the device name of the advertiser in the "Local Name" text box. The text data entered in this text box is displayed as "Device Name" when scanning on the smartphone.

Next, select the maximum value of ATT_MTU accepted from the smartphone side with the pull-down menu after connecting. It is also possible to enter the value from 23 to 247 directly in the text box. The slave side

compares the value select in this menu with the ATT_MTU size received in the Exchange MTU Request from the smartphone side, and the smaller one responds with an Exchange MTU Response.



Figure 7-3. ATT_MTU setting

After completing the settings, click the "▶START" button shown in Figure 7-2 to start advertising.

7.2.2 Scanning start / connection (smartphone side)

Start a Bluetooth LE correspondence application on a Bluetooth 5 correspondence smartphone and perform scanning. This chapter shows an example of using the "GATTBrowser for Android" made by us.

Note: The "GATTBrowser for iOS" of the iOS version has a slightly different display example and screen than the Android version.



Figure 7-4. The GATTBrowser scanning result display

Tap the connection icon "▶" in the EVB advertising information displayed in the GATTBrowser to connect. When connection is established, the Data Communication window and the GATTBrowser screen display will change as follows. Also, the EVB side advertising stops automatically.

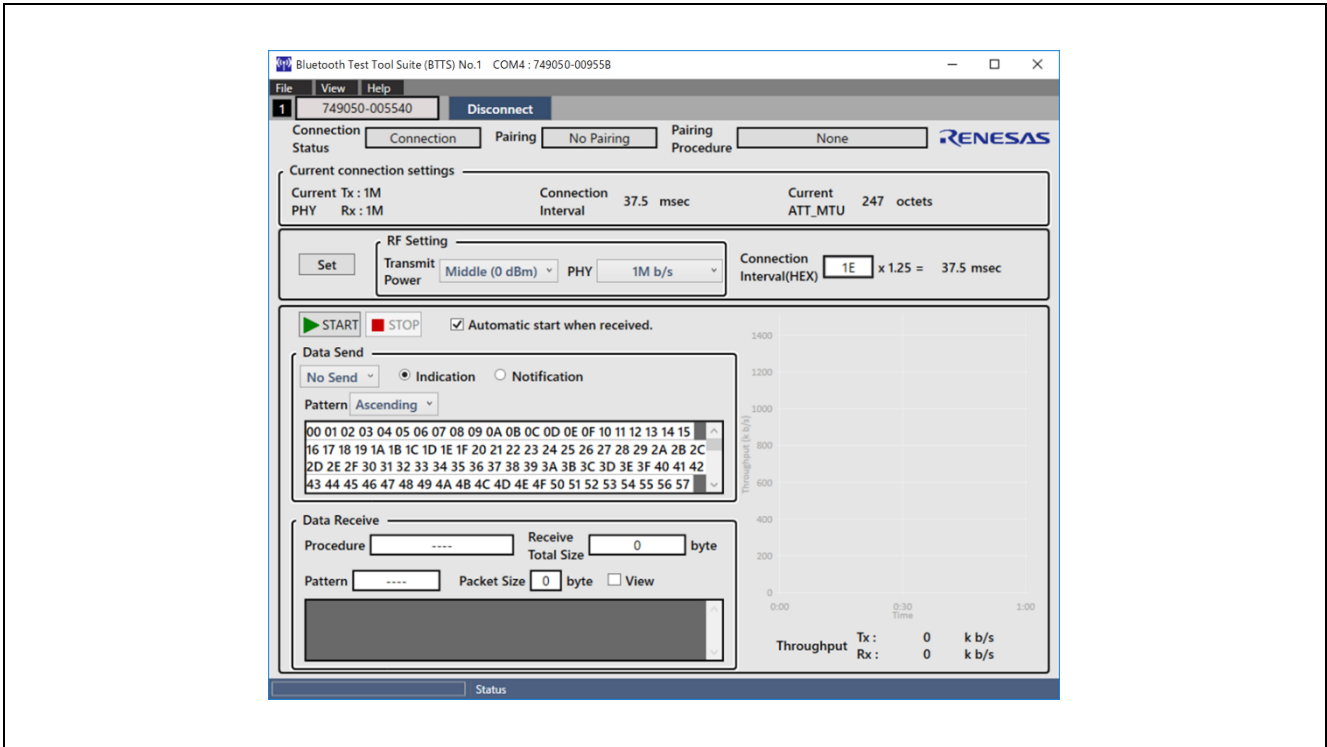

Figure 7-5. Throughput measurement window (Slave)

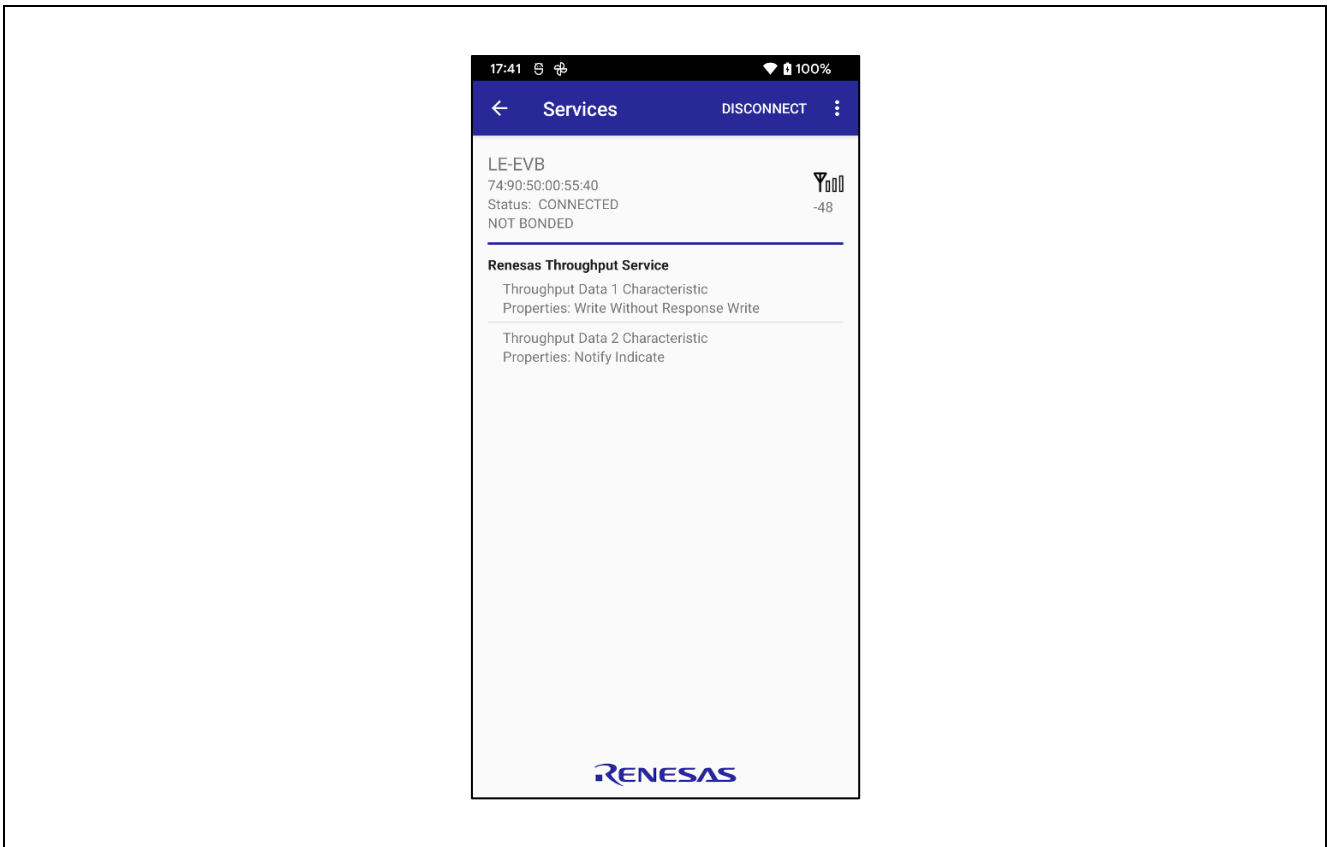

Figure 7-6. Connection screen (GATTBrowser)

7.2.3 Notification transmission permission setting (Smartphone side)

After connection, tap "Throughput Data 2 Characteristic" displayed on the GATTBrowser screen. Then tap "Notification Off" to switch the setting to "Notification On". With this, Notification transmission from MCU is permitted.



Figure 7-7. Characteristics operation screen

7.2.4 Notification transmission start (MCU side)

After permitting Notification on the smartphone side, perform the operation on the Throughput measurement window side.

7.2.4.1 RF setting (MCU side)

Set the RF transmission power with "Transmit Power" in the "RF Setting" frame, and the data transmission speed in the physical layer with "PHY". The transmission power can be switched by selecting Low / Middle (default) / High from the "Transmit Power" pull-down menu. The transmission speed can be switched by selecting 2M / 1M (initial value) / Long Range (500k) / Long Range (125k) from the pull-down menu of "PHY".

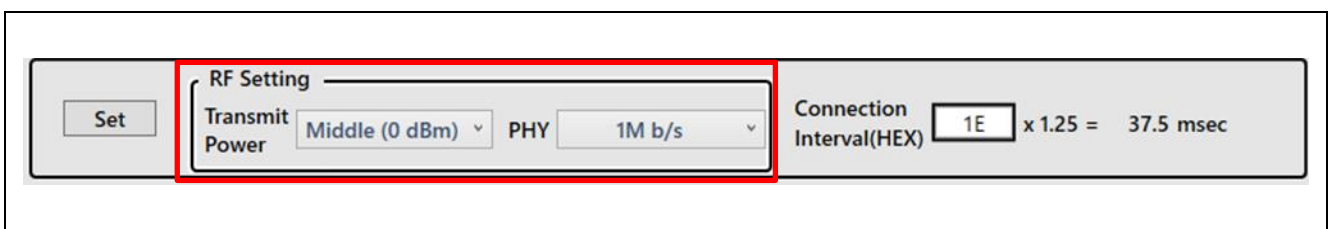

Figure 7-8. RF setting (case of slave side)

Note: The coding scheme (500k / 125k) selected with the "Long Range" pull-down menu of "PHY" is the local side transmission rate. The transmission speed on the remote side is not known on the local side.

7.2.4.2 Connection interval setting (MCU side)

Set the connection interval with the "Connection Interval (HEX)" text box. Input values are in hexadecimal. As you type, the actual set value is calculated and displayed in decimal on the right side of the text box. The input range is 0x6 to 0xC80.

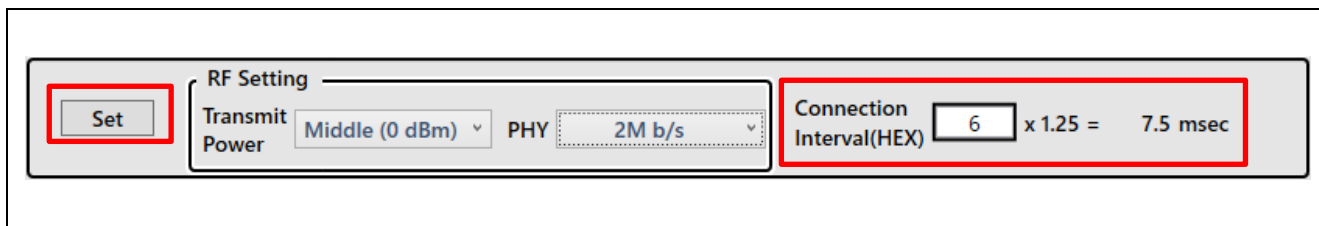

Figure 7-9. Connection interval setting

After performing the above settings, click the "Set" button on the left to reflect the settings. When the settings are reflected, the set contents are displayed in "Current connection settings" at the top. This shows the result of reconcile the setting values between the smartphone and the MCU. The setting values on the MCU side are not necessarily reflected.

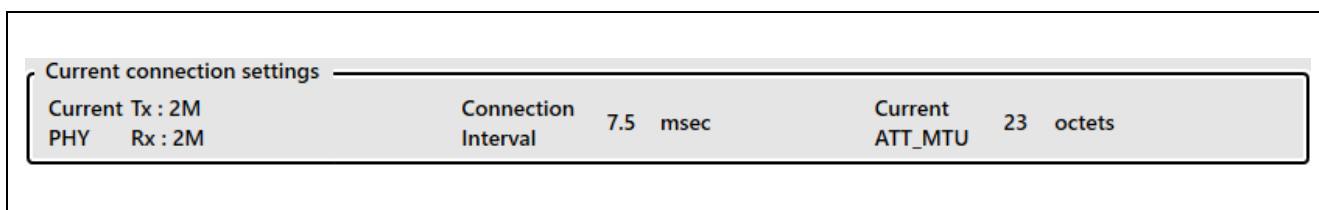

Figure 7-10. Connection setting status display (When the smartphone is the opposite device)

Note: If the smartphone does not support "Long Range", it may only switch to "2M PHY".

Select "Send" from the pull-down menu in the "Data Send" frame, and check that the data transmission type selection radio button is "Notification". After that, click "▶START" button to start continuous notification transmission from MCU.

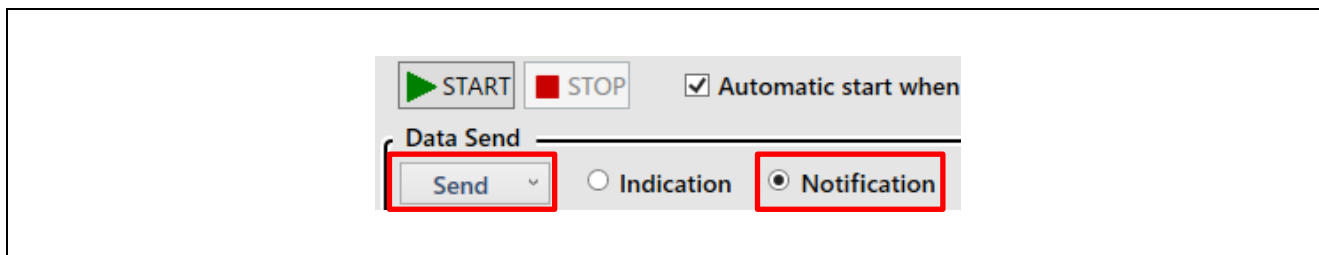

Figure 7-11. Notification continuous transmission start

7.2.5 Throughput confirmation (MCU side)

Clicking the "▶START" button displays the transmission throughput on the right side of the throughput measurement window. Throughput values are plotted every second. The blue line shows the transmission throughput value, and the red line shows the reception throughput value. The latest throughput value is displayed in text at the bottom of the graph display. Clicking the "■STOP" button stops data transmission.

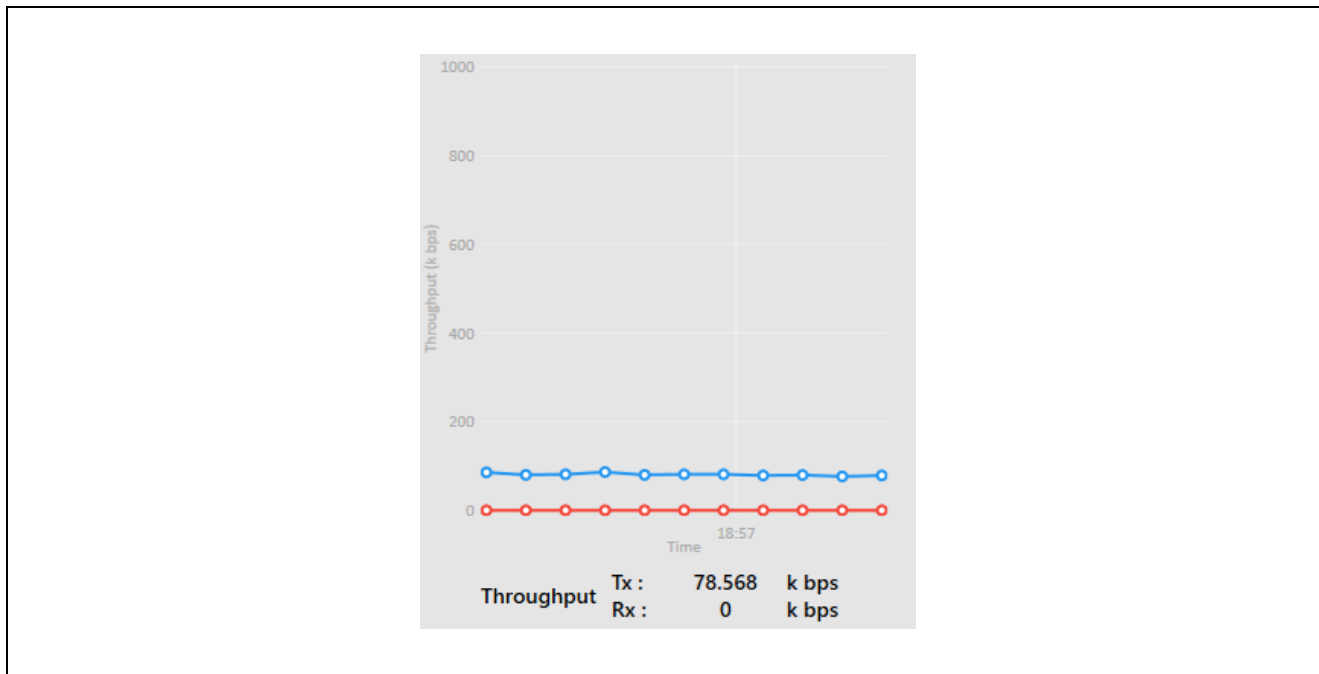

Figure 7-12. Throughput display (slave side)

Note: Depending on the implementation of the protocol stack of the smartphone on which GATTBrowser is operating, Exchange MTU Request may not be executed and communication may be performed with the default ATT_MTU size (23). In this case, a high throughput rate can not be obtained.

7.3 Measure the throughput with the MCU as the opposing device

This chapter describes the procedure for data communication using two the EVB.

Select "Data Comm Master" and "Data Comm Slave" in the tool launcher to start the data communication master tool and data communication slave tool. After startup, connect each the EVB according to the procedure described in 3.3.

Note: When starting throughput measurement, recommend that turn off the API / Event log output function described in 4.2.1 to reduce the processing load on the tool.

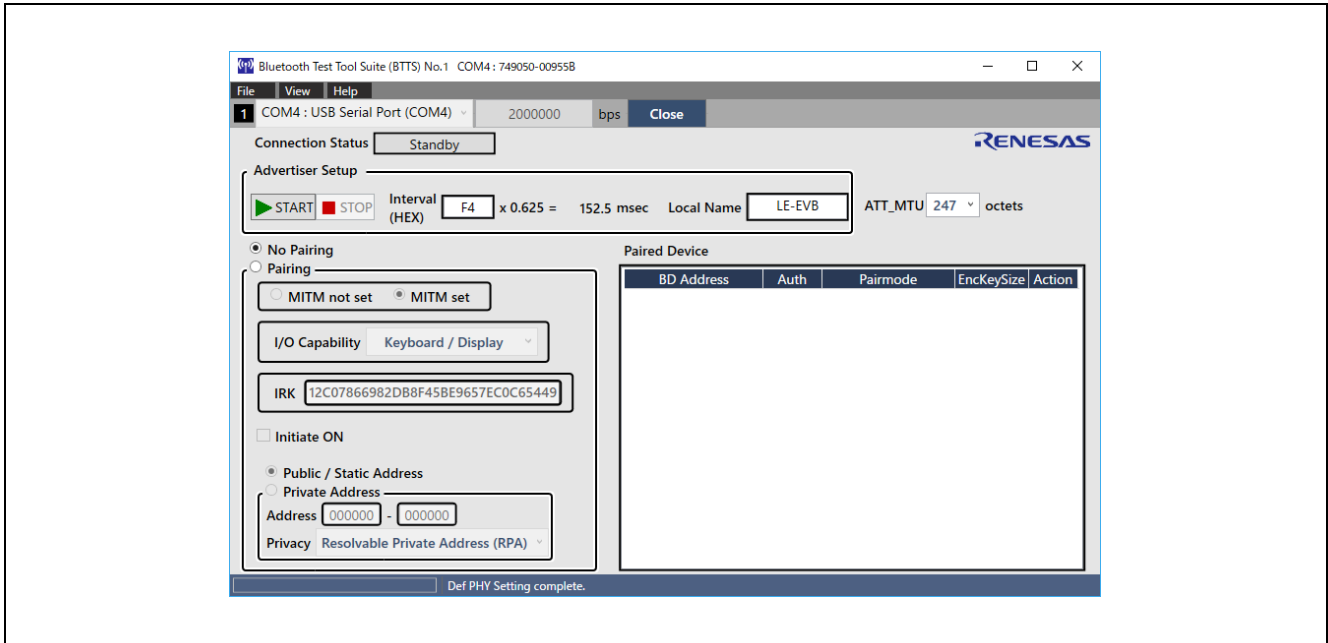

Figure 7-13. Data communication window (Slave)

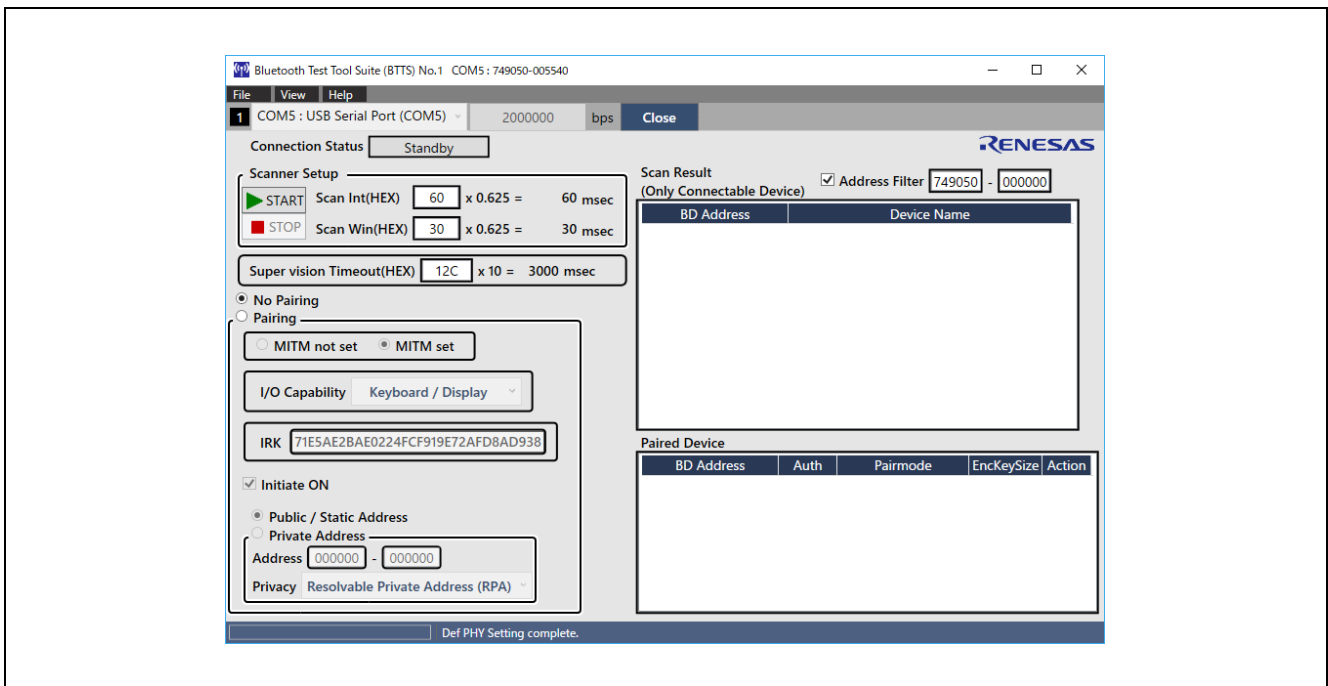

Figure 7-14. Data communication window (Master)

7.3.1 Advertising start (Slave side)

First, make settings for advertising in the data communication window (slave).

Enter the set values to "Interval (HEX)" and "Local Name" in the "Advertiser Setup" frame.

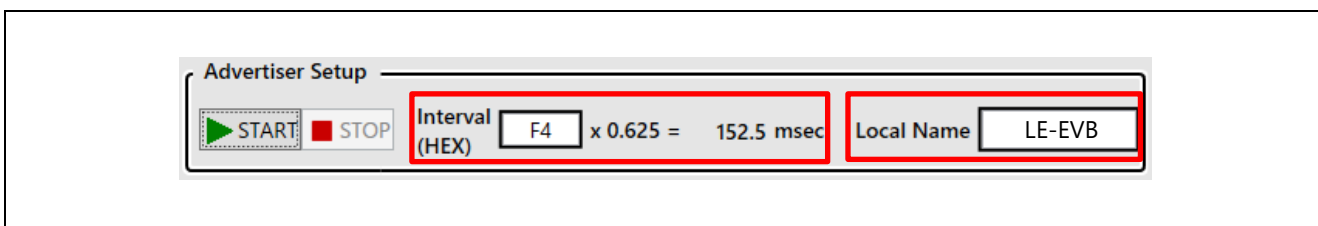

Figure 7-15. Advertising setting display

In the "Interval (HEX)" text box, enter the advertising interval setting value. Input in hexadecimal. When input is completed, the actual setting value is calculated and displayed in decimal on the right side of the text box. The input range is 0x20 to 0x4000. If the set interval is long, it may take time to detect it by the scanning operation on the master side.

Set the advertiser device name in the "Local Name" text box. The text data entered here will be displayed as "Device Name" in the scanning result on the master side.

Next, select the maximum value of ATT_MTU accepted from the master side with the pull-down menu after connection. It is also possible to enter the value from 23 to 247 directly in the text box. The slave side compares the value set in this menu with the ATT_MTU size received in the Exchange MTU Request from the master side, and the smaller value is returned with the Exchange MTU Response.

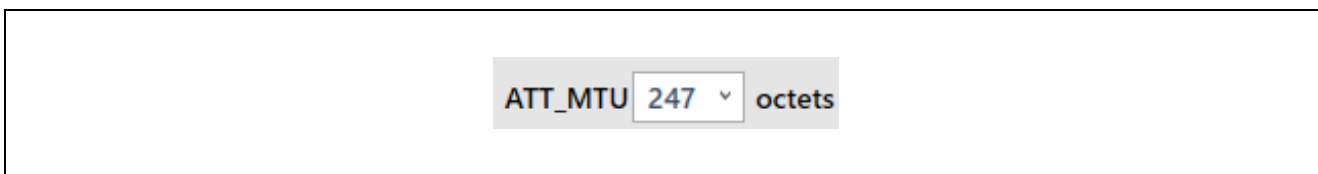

Figure 7-16. ATT_MTU setting

After completing the setting, click the "▶START" button displayed in Figure 7-15 to start advertising.

7.3.2 Scanning start / connection (Master side)

In the data communication window (master), enter the scan interval setting value in the "Scan Int (HEX)" text box in the "Scanner Setup" frame, and the scan window setting value in the "Scan Win (HEX)" text box. Both are entered in hexadecimal. The actual set value(msec) calculated from the entered value is displayed on the right. The input range is 0x4 to 0xFFFF.

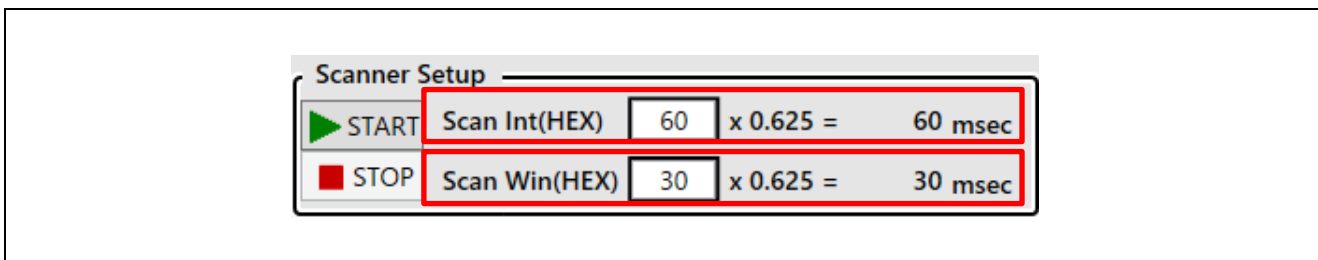

Figure 7-17. Scanner settings

Also, set the supervision timeout value for determine that the connection has been lost with "Super vision Timeout (HEX)". Input is in hexadecimal, and the actual set value (msec) calculated from the input value is displayed on the right. The input range is 0xA to 0xC80.

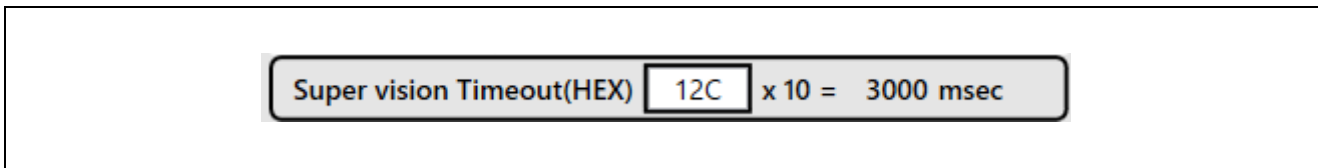

Figure 7-18. Supervision timeout setting

Next, set the scanning result filter. A filter that displays only connectable advertisers is always applied to the scanning results. If you check "Address Filter", the filter by BD address is enabled. If the value of the vendor management field (right side of the text box) is "000000", only devices with addresses that match the OUI field (left side of the text box) are displayed in the scanning result list. If the value of the vendor management field is other than "000000", the specified address is registered in the "White List", and only devices whose addresses completely match are displayed in the list. In the example below, only the advertiser whose BD address when scanning is "749050-XXXXXX" (XXXXXX is an arbitrary address) is displayed.

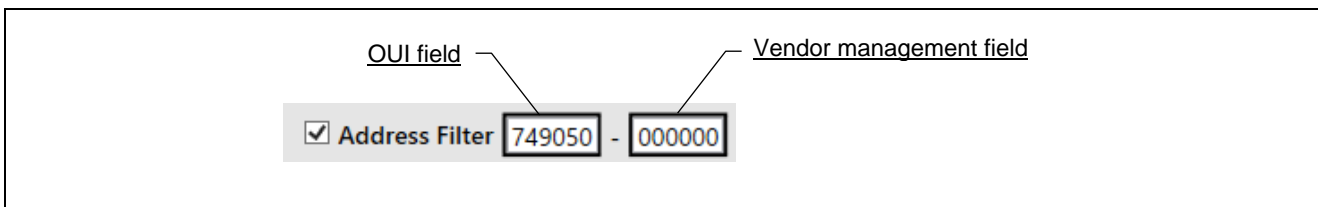

Figure 7-19. Address Filter setting

After completing the settings, click the "▶START" button shown in Figure 7-17 to start scanning. The scanned result is displayed in "Scan Result (Only Connectable Device)" on the right side of the data communication window (master).

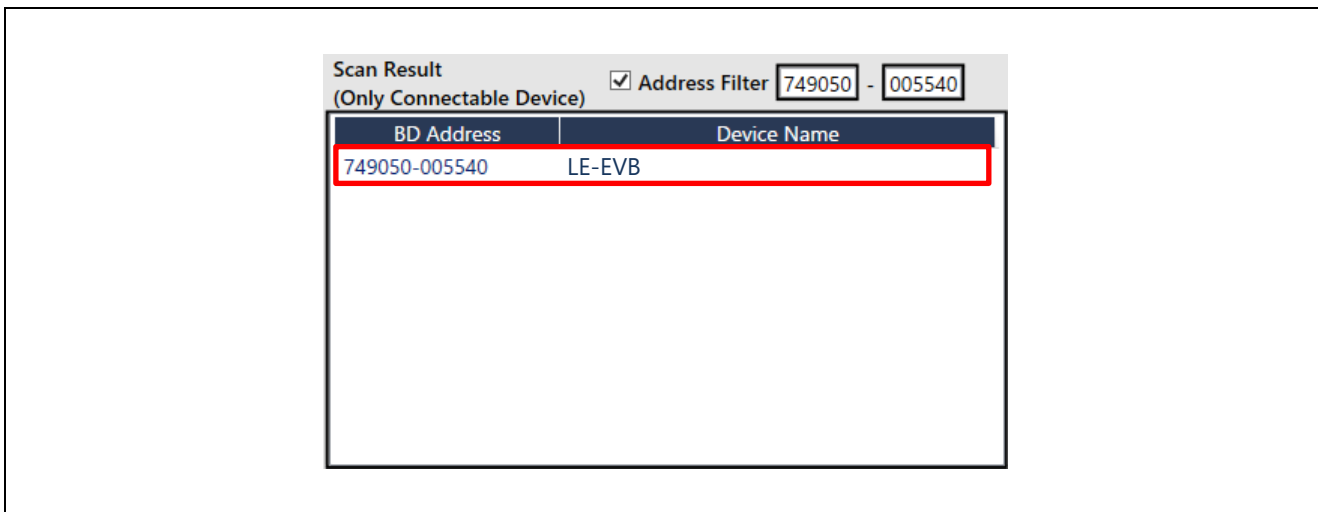

Figure 7-20. Scanning result display

Double clicking the target device displayed in the scanning result starts connection from the master side. When the connection is established, the Data Communication window (Slave) and Data Communication

window (Master) are each switched to the Throughput measurement window. Slave side advertising and master side scanning operations automatically stop. At this stage, "Notification" and "Indication" transmissions on the slave side are automatically set to "permitted" from the master side.

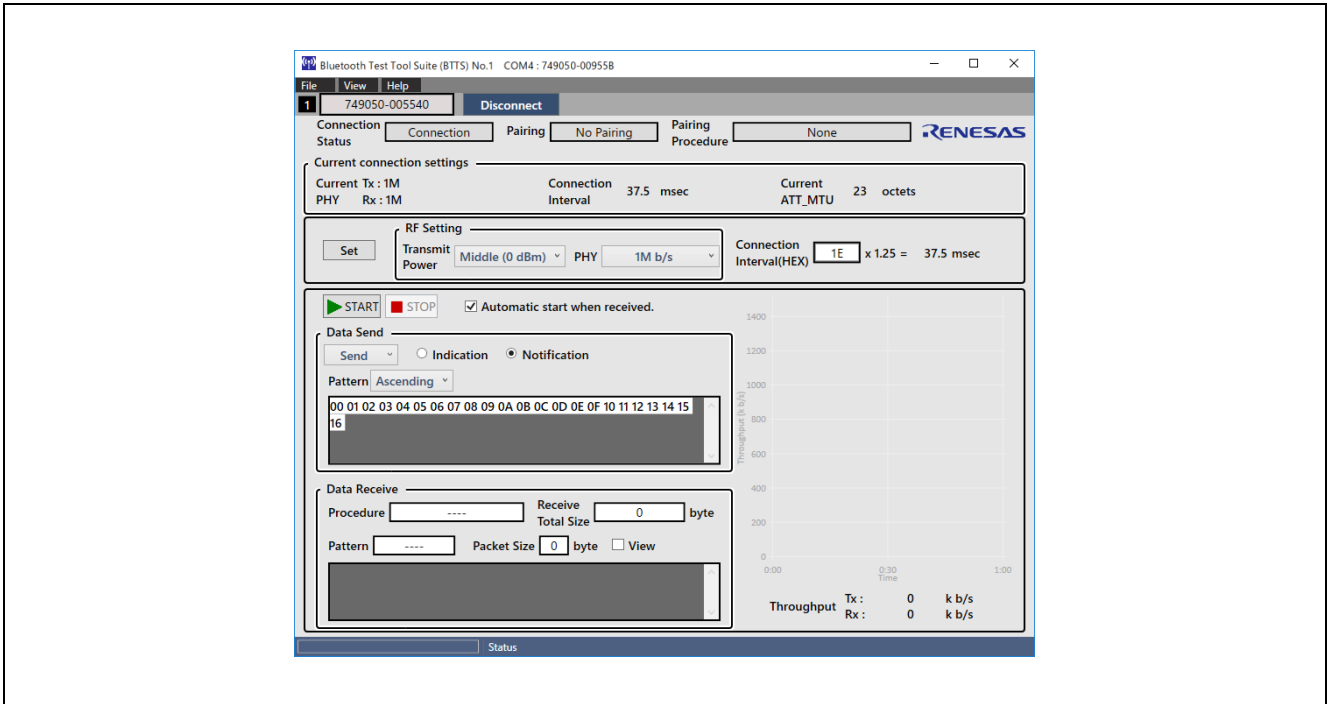

Figure 7-21. Throughput measurement window (Slave)

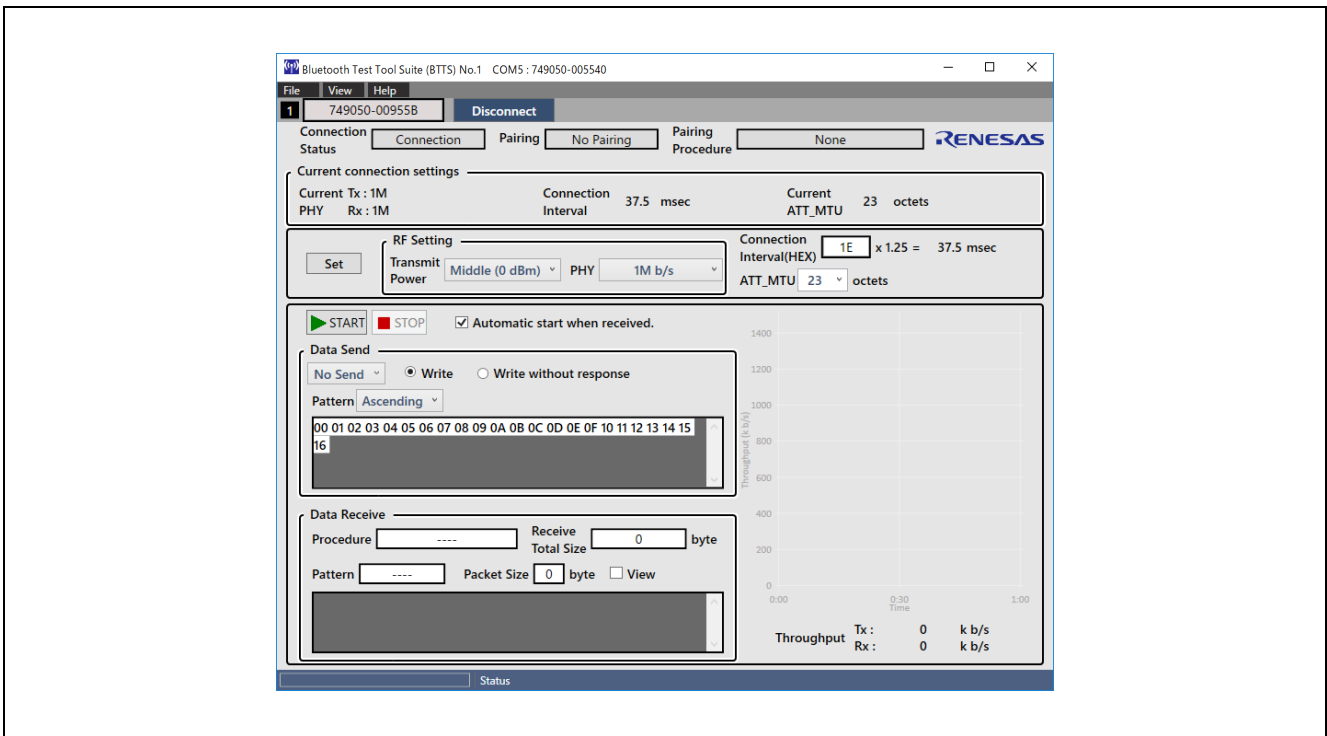

Figure 7-22. Throughput measurement window (Master)

7.3.3 RF setting / Connection interval setting (Slave side)

Once the connection is established, set the RF transmission power with "Transmit Power" in the "RF Setting" frame of the throughput measurement window (slave), and the data transmission speed in the physical layer with "PHY". The transmission power can be switched by selecting Low / Middle (default) / High from the "Transmit Power" pull-down menu. The transmission speed can be switched by selecting 2M / 1M (initial value) / Long Range (500k) / Long Range (125k) from the pull-down menu of "PHY".

Also, set the connection interval with the "Connection Interval (HEX)" text box. Input values are in hexadecimal. As you type, the actual set value is calculated and displayed in decimal on the right side of the text box. The input range is 0x6 to 0xC80.

After performing the settings, click the "Set" button on the left to reflect the settings.

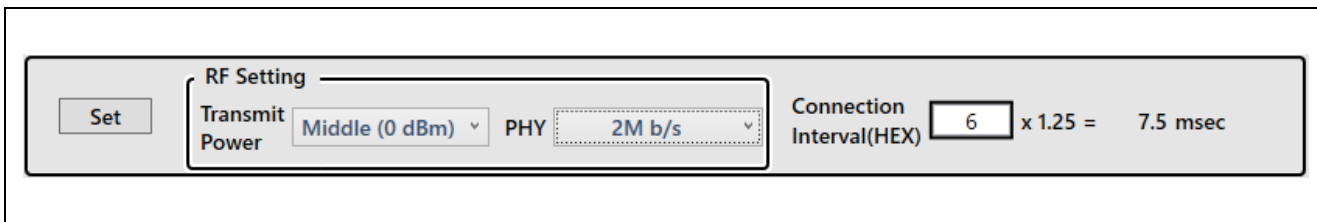

Figure 7-23. Slave side RF setting

7.3.4 RF setting, Connection interval setting, ATT_MTU setting (Master side)

In the Throughput measurement window (master), you can set the ATT_MTU value in addition to the same RF settings and connection interval settings as on the slave side. The value set here is sent to the slave side by Exchange MTU Request. The slave side compares the requested ATT_MTU value with ATT_MTU setting value on the local, and returns the smaller one with an Exchange MTU Response. This determines the value of both ATT_MTU.

After setting, click the "Set" button on the left side to reflect the setting.



Figure 7-24. Master side RF setting

At this time, each setting is negotiated between the master and slave, and the result is displayed in "Current connection settings" at the top of the window for both the master and slave sides.

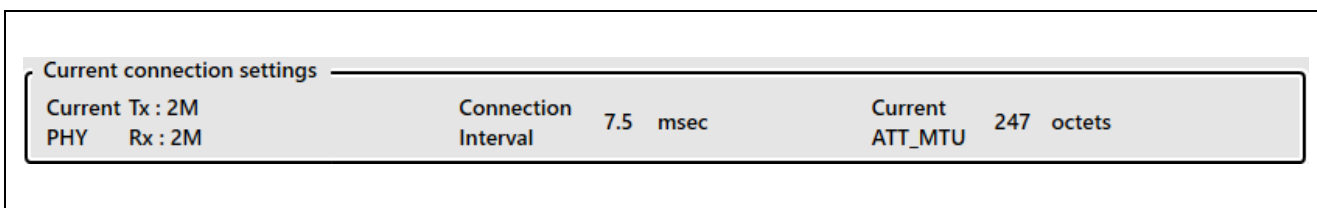

Figure 7-25. Connection setting status display (Both opposing device is MCU)

The data length to be transmitted changes according to the updated ATT_MTU value. The display of the transmission data text in the "Data Send" frame on both the master and slave sides is updated.

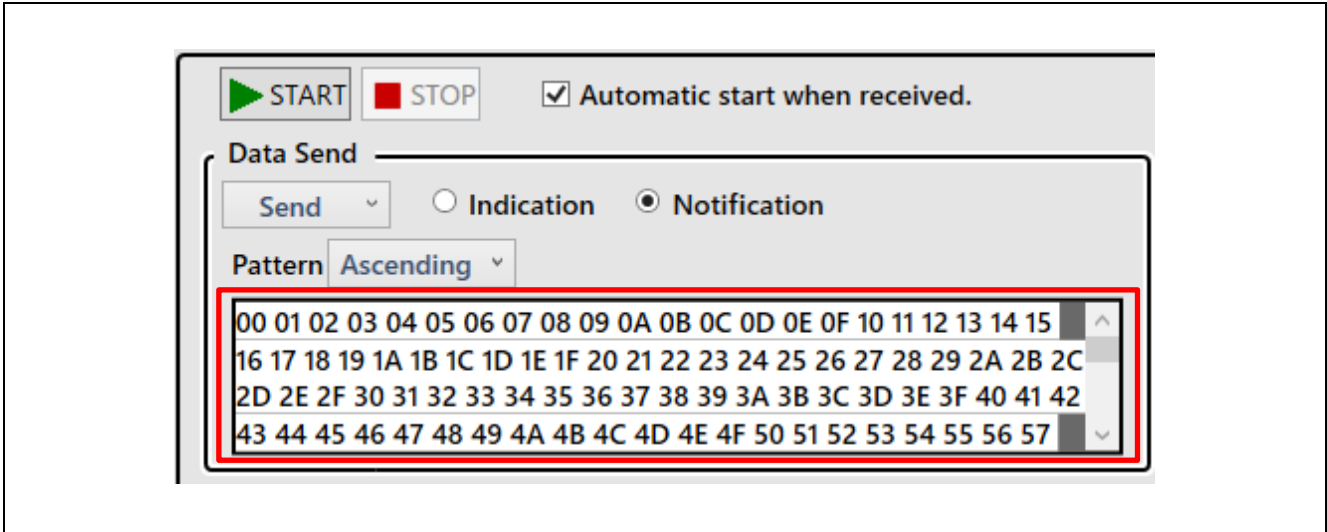

Figure 7-26. Transmission data text display (Slave side display example)

7.3.5 Notification transmission throughput measurement (Slave side)

This section describes the procedure for measuring the throughput of Notification transmission from the slave side.

First, in the Throughput measurement window (Master), select "No Send" from the pull-down menu in the "Data Send" frame. This setting prevents data transmission from the master for throughput measurement. The slave side select "Send" in the Throughput measurement window (Slave).

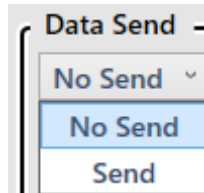

Figure 7-27. Data transmission pull-down menu

Make sure that the "Automatic start when received" checkbox is checked on the master side.

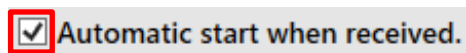

Figure 7-28. Automatic start when received check box (Master side)

Start data transmission from the slave side. Check that the data transmission type selection radio button in the "Data Send" frame is "Notification" and click the "▶START" button.



Figure 7-29. Data transmission type selection radio button (Slave side)

When the sending of Notification data from the slave side is started, the master side receives the Notification data from the slave and the throughput measurement starts automatically, and the throughput information is displayed on the right side of the throughput measurement window of both the master and slave. Throughput values are plotted every second. The blue line shows the transmission throughput value, and the red line shows the reception throughput value. The latest throughput value is displayed in text at the bottom of the graph display.

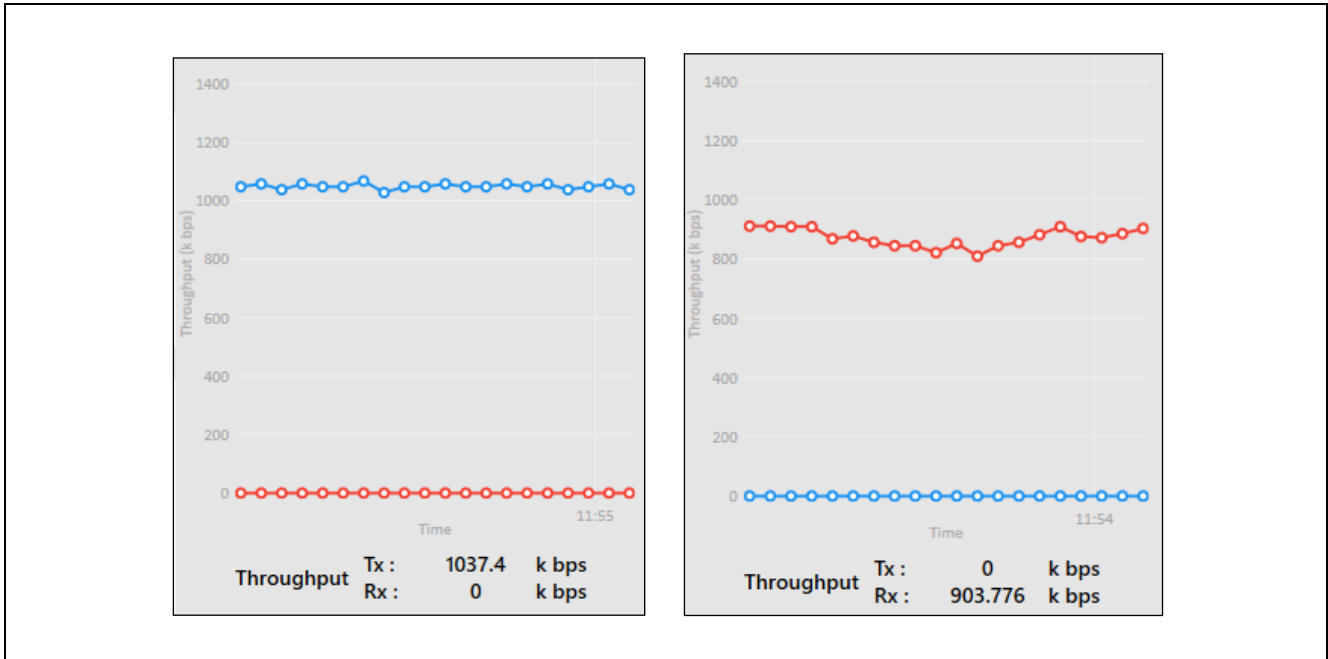

Figure 7-30. Throughput display example (Left: Slave side, Right: Master side)

Note: Throughput fluctuate on the influence of wireless communication such as surrounding Bluetooth and Wi-Fi.

7.3.6 Write without response transmission throughput measurement (Master side)

This section describes the procedure for measuring the throughput of Write without response transmission from the master side.

First, in the Throughput measurement window (Slave), select "No Send" from the pull-down menu in the "Data Send" frame. This setting prevents data transmission from the slave for throughput measurement. The master side select "Send" in the Throughput measurement window (Master).

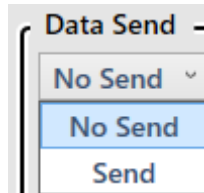

Figure 7-31. Data transmission pull-down menu

Make sure that the "Automatic start when received" checkbox is checked on the slave side.

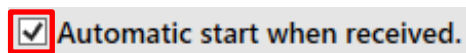

Figure 7-32. Automatic start when received check box (Slave side)

Start data transmission from the master side. Check that the data transmission type selection radio button in the "Data Send" frame is "Write without response" and click the "▶START" button.

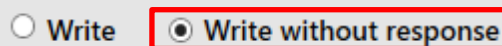

Figure 7-33. Data transmission type selection radio button (Master side)

When the sending of Write without response data from the master side is started, the slave side receives the Write without response data from the master and the throughput measurement starts automatically, and the throughput information is displayed on the right side of the throughput measurement window of both the master and slave. Throughput values are plotted every second. The blue line shows the transmission throughput value, and the red line shows the reception throughput value. The latest throughput value is displayed in text at the bottom of the graph display.

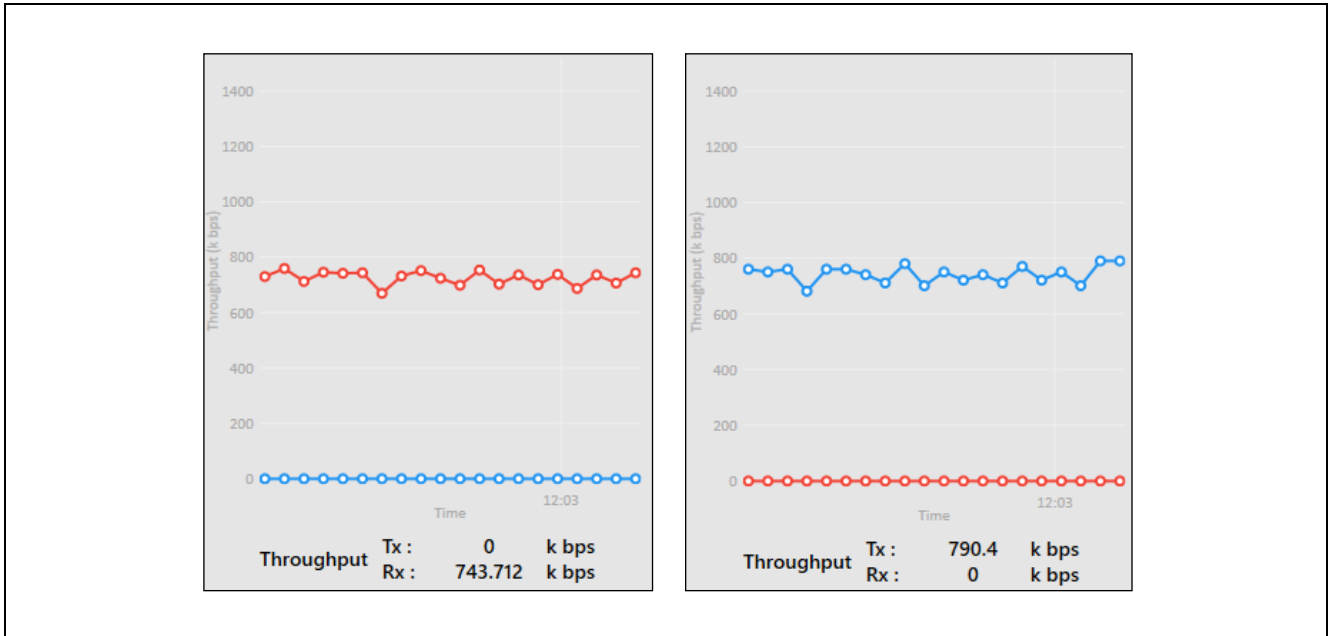

Figure 7-34. Throughput display example (Left: Slave side, Right: Master side)

Note: Throughput fluctuate on the influence of wireless communication such as surrounding Bluetooth and Wi-Fi.

7.4 Pairing Execution

This chapter describes about pairing a Bluetooth device.

7.4.1 Pairing with the smartphone

This chapter describes the procedure for pairing the MCU (slave) and the smartphone (master).

Note: When pairing is performed by connecting to a Bluetooth 4.1 and earlier smartphone or a smartphone that does not support "LE Secure Connections", the pairing procedure by "Legacy Pairing" is executed.

Select "Data Comm Slave" in the tool launcher to start the Data Communication Slave tool. Connect the EVB according to the procedure described in 3.3.

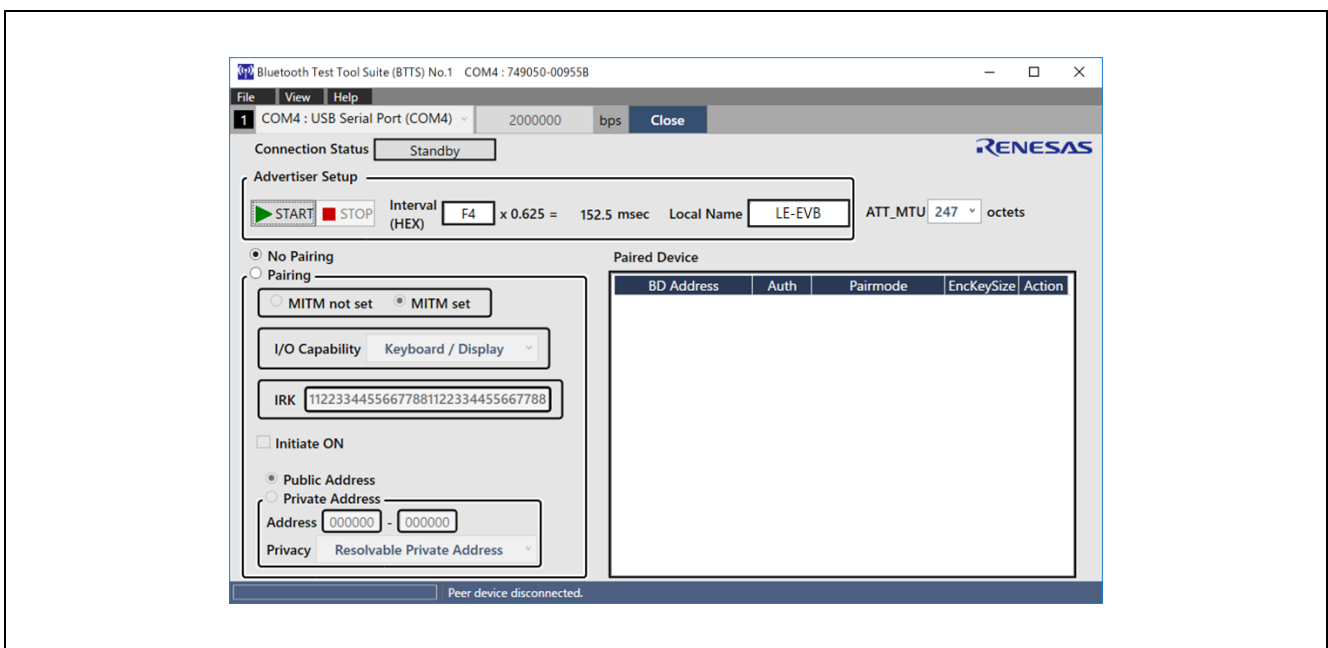

Figure 7-35. Data communication window (Slave)

- After EVB connection, check the "Pairing" radio button and set to perform pairing.

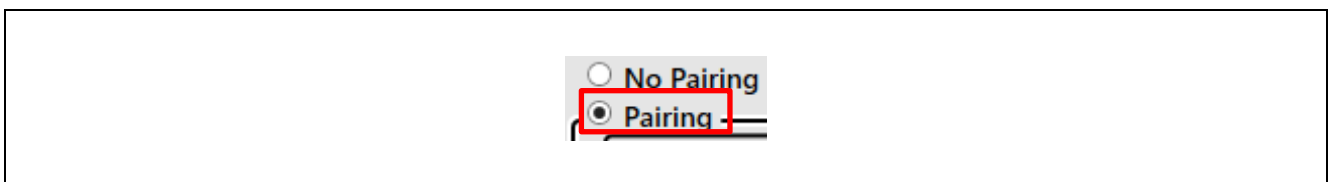

Figure 7-36. Pairing setting

- Set "Enable / Disable" for Man In The Middle (MITM) protection. In this example, check the "MITM set" radio button to enable MITM protection.

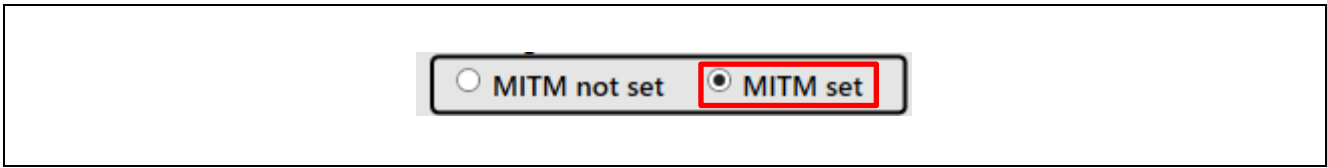

Figure 7-37. MITM setting

- Set I / O Capability with the pull-down menu. In this example, select "Keyboard / Display".

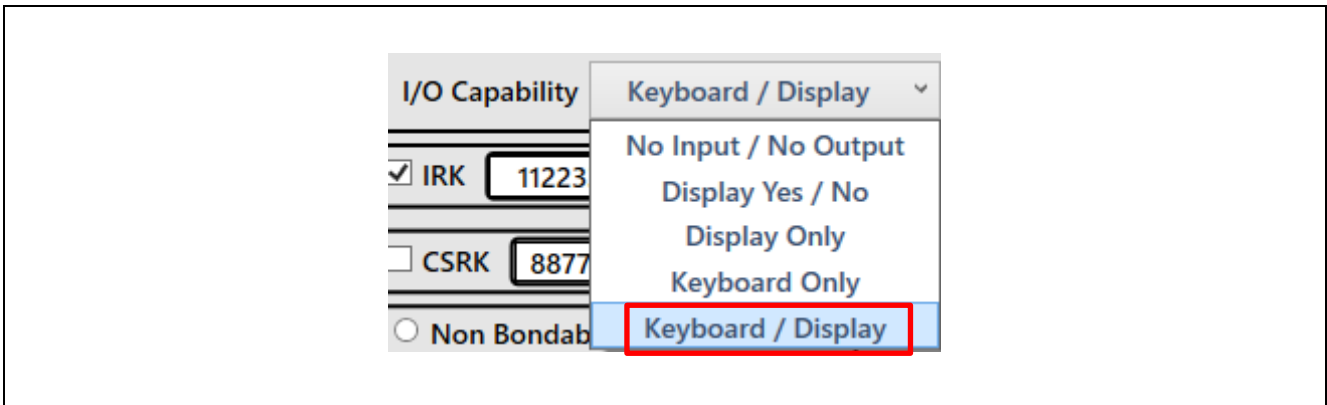

Figure 7-38. I/O Capability setting

The security type between the MCU and the smartphone is determined by the logic shown in Table 7-1 based on the settings of both "MITM" and "I/O Capability". Smartphone I/O Capability is usually "Keyboard Display".

Table 7-1. Security type decision logic

●"MITM" protection and "I / O Capability"

Responder	Initiator	
	MITM Set	MITM Not Set
MITM Set	Refer to IO Capabilities Table	Refer to IO Capabilities Table
MITM Not Set	Refer to IO Capabilities Table	Just Works

●IO Capabilities Table

Responder	Initiator				
	DisplayOnly	Display YesNo	KeyboardOnly	NoInput NoOutput	Keyboard Display
DisplayOnly	Just Works	Just Works	Passkey Entry	Just Works	Passkey Entry
Display YesNo	Just Works	(Just Works) Numeric Comparison	Passkey Entry	Just Works	(Passkey Entry) Numeric Comparison
KeyboardOnly	Passkey Entry	Passkey Entry	Passkey Entry	Just Works	Passkey Entry
NoInput NoOutput	Just Works	Just Works	Just Works	Just Works	Just Works
Keyboard Display	Passkey Entry	(Passkey Entry) Numeric Comparison	Passkey Entry	Just Works	(Passkey Entry) Numeric Comparison

Note: "()" Is the operation for case of the LE Legacy Pairing

- Set the pairing key. Set an arbitrary key other than all zeros in hexadecimal 16 bytes in the Identity Resolving Key (IRK) text box. The BTTS sets a 16-byte random number generated using the Bluetooth protocol stack API (R_BLE_VS_GetRand) when connecting to EVB for the first time. If you want to change the settings, click the "IRK" label (inside the dashed frame in Figure 7-39).



Figure 7-39. Pairing key Setting

- Set whether or not to perform the pairing request (initiator). Since it is common to make a pairing request from the master side, uncheck the "Initiate ON" checkbox.

Note: iOS smartphones do not make pairing requests. For iOS smartphones, check the "Initiate ON" checkbox.

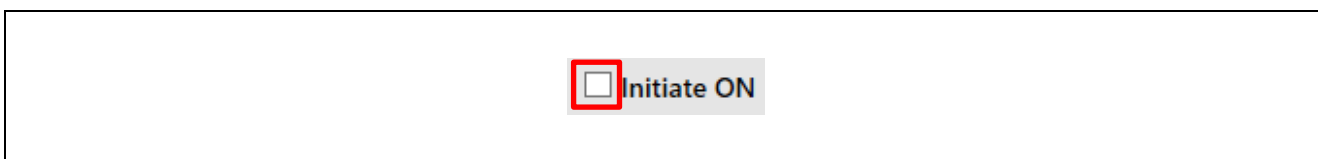

Figure 7-40. Initiate Setting

- Finally, set the BD address type with the radio button. In this example, select "Public / Static Address". If "Private Address" is selected, specify the privacy type in the "Privacy" pull-down menu. Privacy types are "Resolvable Private Address (RPA)" and "Non-RPA", but only "RPA" can be selected in the Data Communication tool.

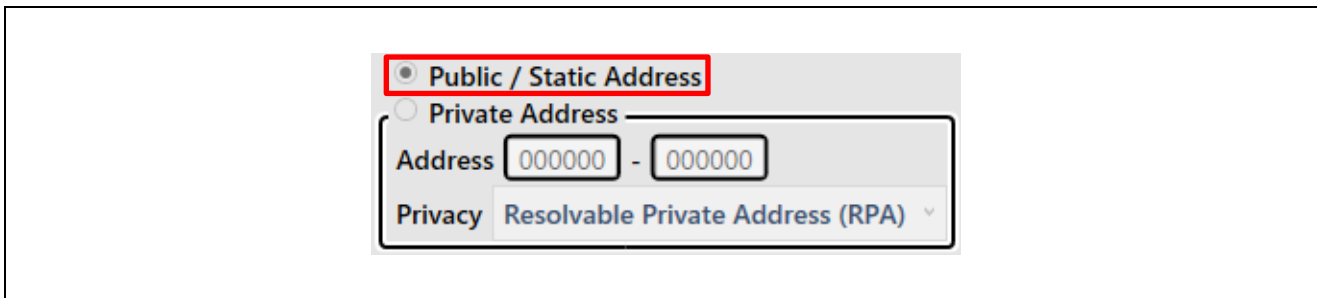

Figure 7-41. BD address type setting

- When finished setting, click "▶START" button to start advertising on MCU (Slave) side. On the Bluetooth 5 supported smartphone (Master) side, start the Bluetooth LE supported application, perform scanning, connect to the EVB, and then start pairing.
- When the connection is completed, the pairing process is starts according to the logic shown in Table 7-1. When MITM protection is enabled on the MCU side, the security type that operates when pairing with a smartphone changes depending on the selected "I/O Capability" (see Table 7-2).

Table 7-2. Operating security type (opposite device is a smartphone)

I/O Capability	Security type
No Input / No Output	Just Works (No action)
Display Only	Passkey Entry (Display passkey display dialog)
Keyboard Only	Passkey Entry (Display passkey input dialog)
Display / YesNo Keyboard / Display	Numeric Comparison (Display numeric comparison dialog)

If the security type is "Just Works", pairing is completed with no action. When the security type is "Passkey Entry", the "passkey display" or "passkey input" dialog is displayed. If a passkey is displayed, on the smartphone side enter the passkey displayed in the dialog. At this time, the displayed passkey is automatically generated by the lower layer (protocol stack). Also, In the upper right part of the dialog, the time until timeout is displayed.

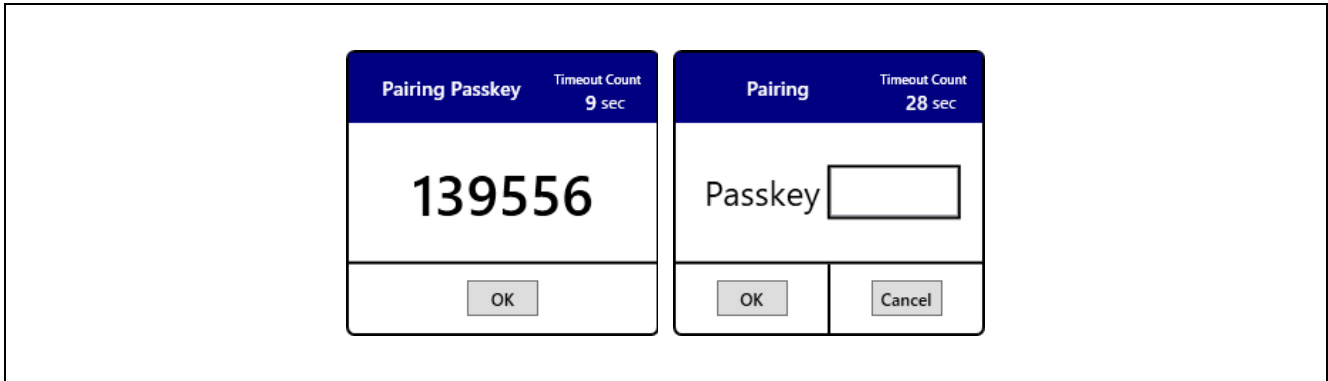

Figure 7-42. Passkey display / passkey input dialog

When "Numeric Comparison" is used to security, the following "Numeric Comparison Confirmation" dialog is displayed. If the same value is displayed on both the smartphone and MCU, click the "OK" button to continue the pairing process. If the displayed values are different, click the "Cancel" button to cancel the pairing process. The numerical value is automatically generated by the lower layer (protocol stack) same as "Passkey Entry". In the upper right part of this dialog, the time until timeout is displayed.

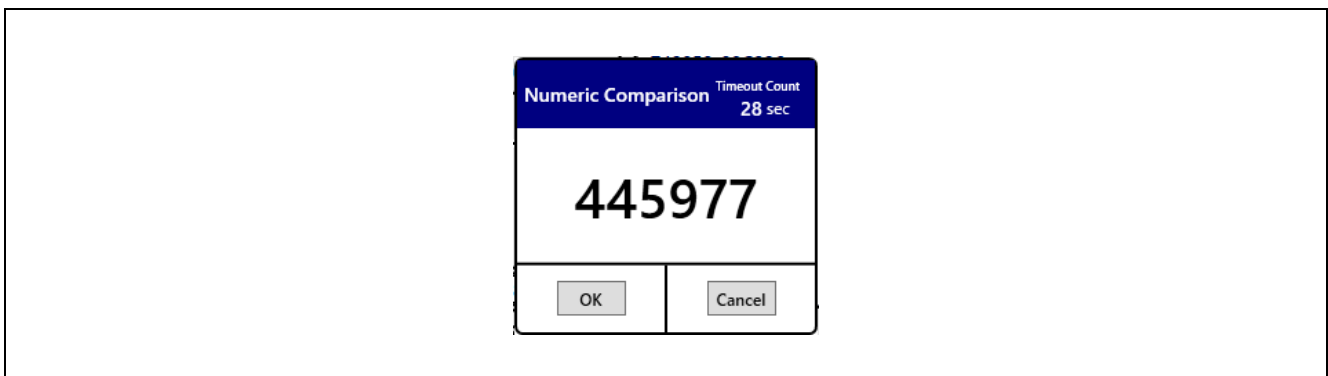

Figure 7-43. Numeric Comparison Confirmation dialog

- When pairing is successful, the screen switches to the throughput measurement window and data communication is possible. The pairing procedure ("LE Secure Connections" or "Legacy Pairing") executed when connecting with the smartphone is displayed in "Pairing Procedure" in the status display section of the throughput measurement window.

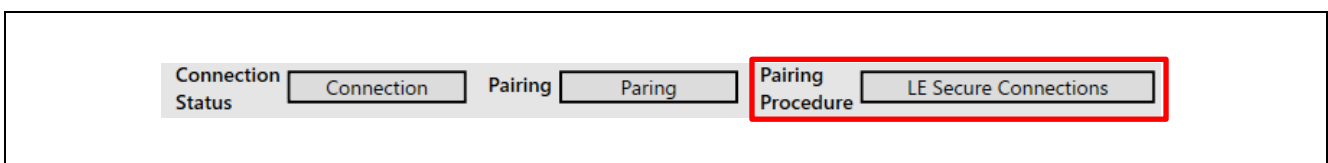

Figure 7-44. Status display (In the case of LE Secure Connections)

If you check the "Paired Device" list after disconnecting communication, information on the paired device has been added. Security information obtained during pairing is displayed in the list.

By clicking the "Del" button in the list, the pairing information of select device can be deleted.

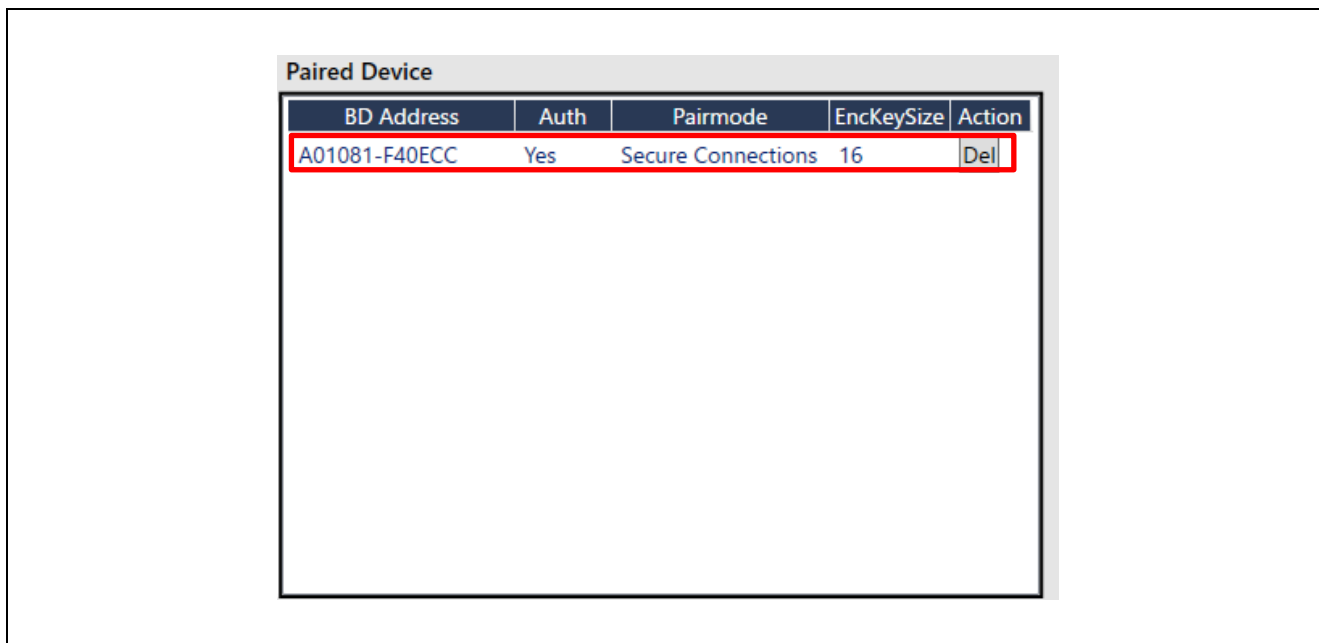

Figure 7-45. "Paired Device" list display

Note: If you delete the pairing information, you will not be able to reconnect to the smartphone. To reconnect, delete the pairing information registered on the smartphone.

7.4.2 Pairing between MCUs

This chapter describes the procedure for pairing with EVBs facing each other.

Note: When pairing between MCUs, the pairing procedure by "LE Secure Connections" is automatically executed.(Pairing procedure by "Legacy Pairing" is not executed)

Select "Data Comm Master" and "Data Comm Slave" in the tool launcher to start the Data Communication Master Tool and Data Communication Slave Tool. After startup, connect each EVB according to the procedure described in 3.3.

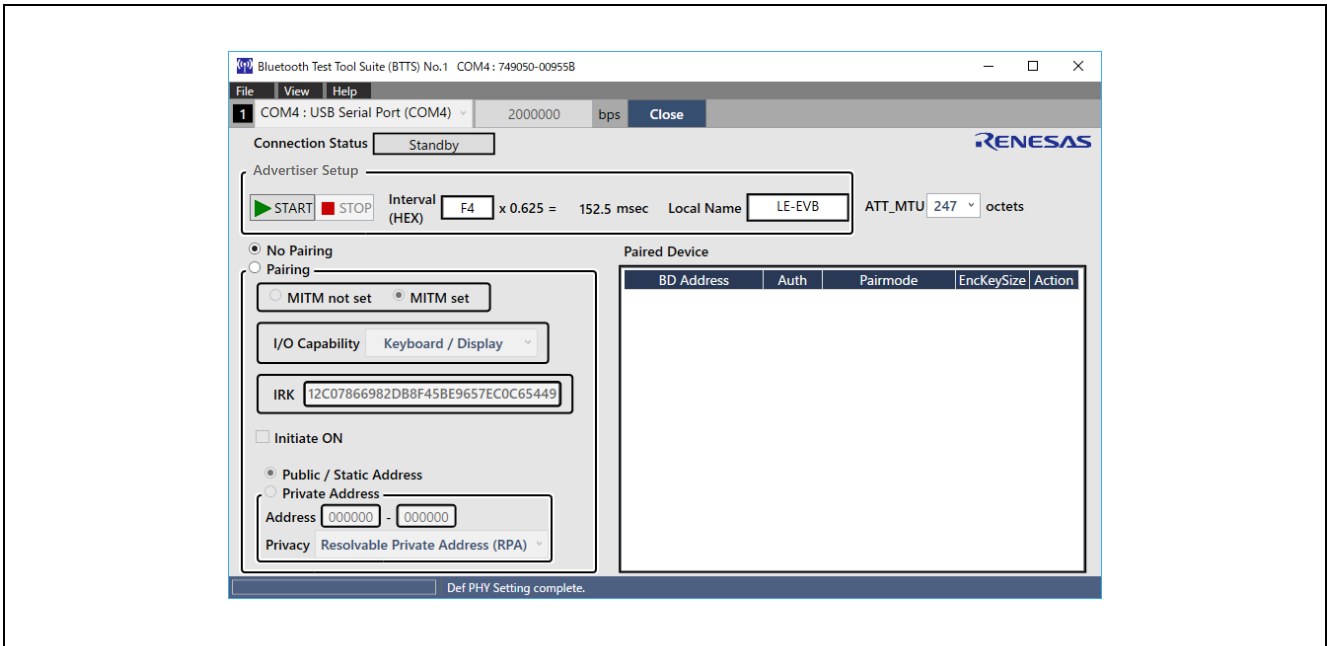

Figure 7-46. Data communication window (Slave)

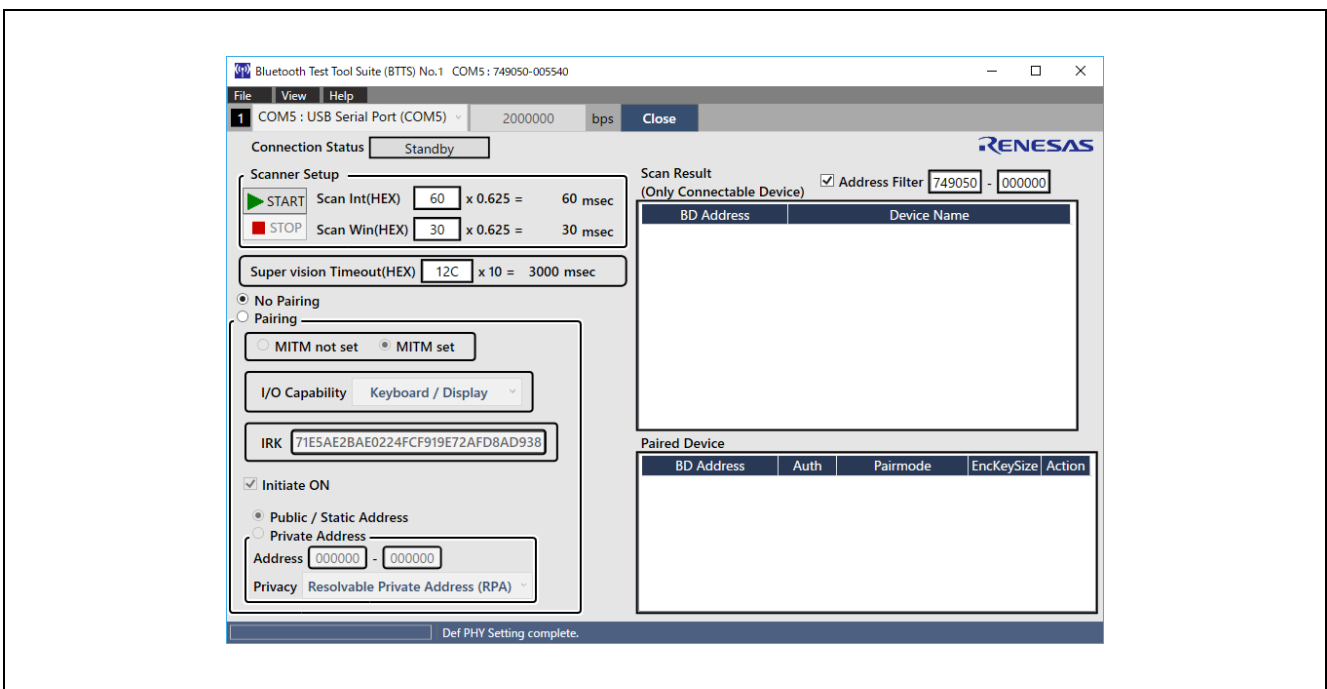

Figure 7-47. Data communication window (Master)

- After EVB connection, check the "Pairing" radio button and set to perform pairing on both master and slave.

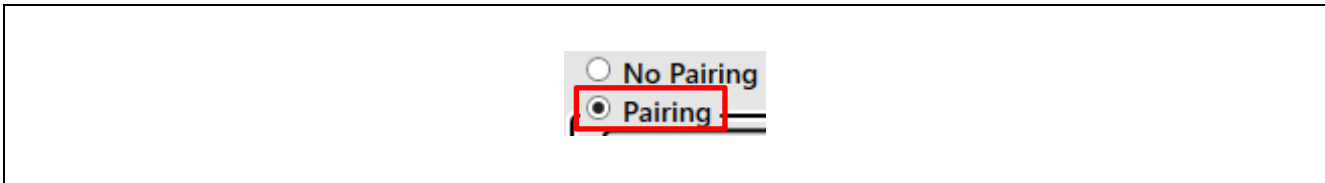

Figure 7-48. Pairing setting

- Set "Enable / Disable" for Man In The Middle (MITM) protection. In this example, both the master and slave check the "MITM set" radio button to enable MITM protection.

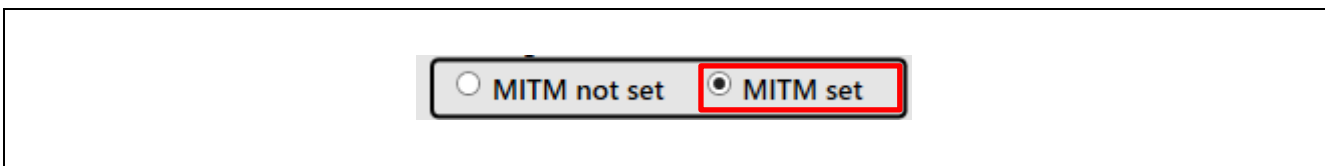

Figure 7-49. MITM setting

- Set I/O Capability with the pull-down menu. In this example, select "Keyboard / Display" for both master and slave.

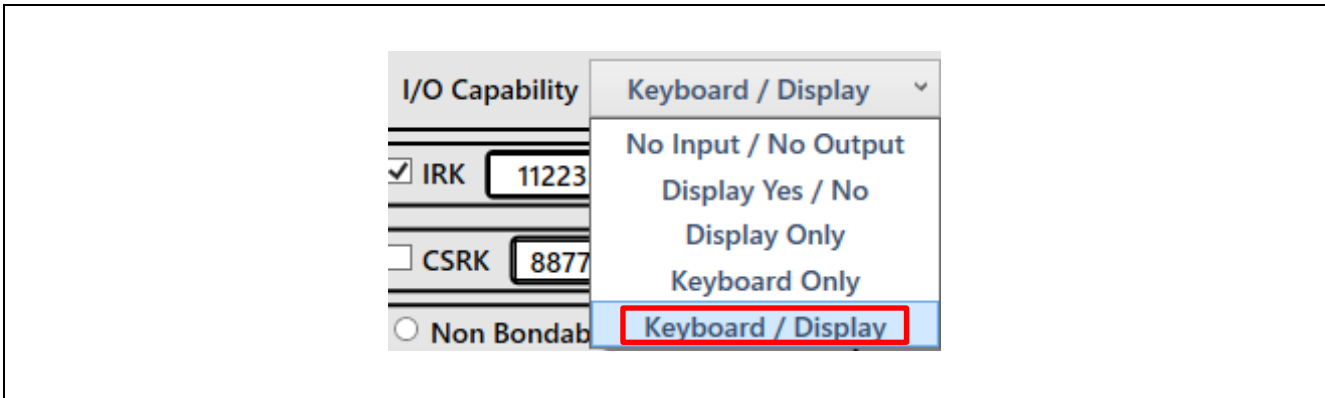

Figure 7-50. I/O Capability setting

The security type between the MCUs is determined by the logic shown in Table 71 based on the settings of both "MITM" and "I / O Capability".

- Set the pairing key with both master and slave. Set an arbitrary key other than all zeros in hexadecimal 16 bytes in the Identity Resolving Key (IRK) text box. The BTTS sets a 16-byte random number generated using the Bluetooth protocol stack API (R_BLE_VS_GetRand) when connecting to EVB for the first time. If you want to change the settings, click the "IRK" label (inside the dashed frame in Figure 7-51).



Figure 7-51. Pairing key Setting

- Set whether to perform the pairing request (Initiator) or wait for the pairing request (Responder). In this example, in accordance with general use cases, check the "Initiate ON" check box on the master side to be an initiator, and uncheck on the slave side to be a responder.



Figure 7-52. Initiate Setting (Master side: check, Slave side: uncheck)

- Finally, set the BD address type with the radio button. In this example, select "Public / Static Address". If "Private Address" is selected, specify the privacy type in the "Privacy" pull-down menu. Privacy types are "Resolvable Private Address (RPA)" and "Non-RPA", but only "RPA" can be selected in the Data Communication tool.

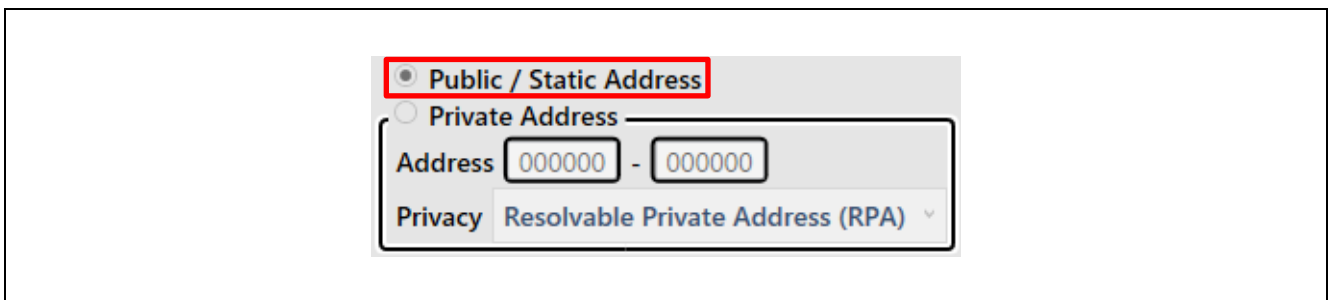

Figure 7-53. BD address type setting

- After completing the settings, click the "▶START" button on the slave side to start advertising. Click the "▶START" button on the master side to start scanning and connect to the slave.

- When the connection is completed, the pairing processing starts according to the logic shown in Table 7-1. In this example operate the "Numeric Comparison". The "Numeric comparison confirmation" dialog is displayed on both the master and slave. If the same value is displayed on both sides, click the "OK" button to continue the pairing process. If the displayed values are different, click the "Cancel" button to cancel the pairing process. The numerical value is automatically generated by the lower layer (protocol stack) same as the passkey. In the upper right part of this dialog, the time until timeout is displayed.

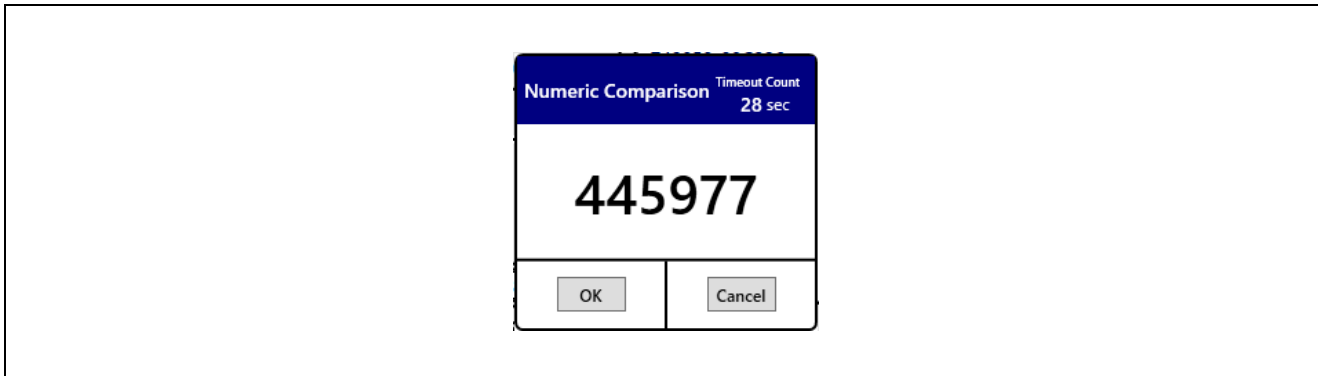

Figure 7-54. Numeric Comparison Confirmation dialog

- When pairing is successful, both the master and slave, the screen switches to the throughput measurement window and data communication will be possible. The executed pairing procedure "LE Secure Connections" is displayed in "Pairing Procedure" in the status display section of the throughput measurement window.

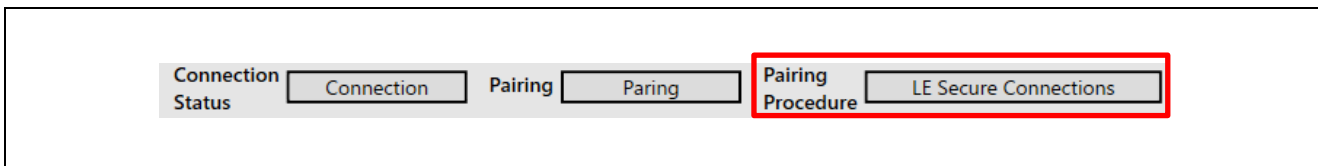

Figure 7-55. Status display (In the case of between the MCUs)

If you check the "Paired Device" list after disconnecting communication, information on the paired device has been added. Security information obtained during pairing is displayed in the list.

By clicking the "Del" button in the list, the pairing information of select device can be deleted.

Up to 7 devices can be registered. When pairing with the 8th device, pairing information at the top of the list is automatically deleted.

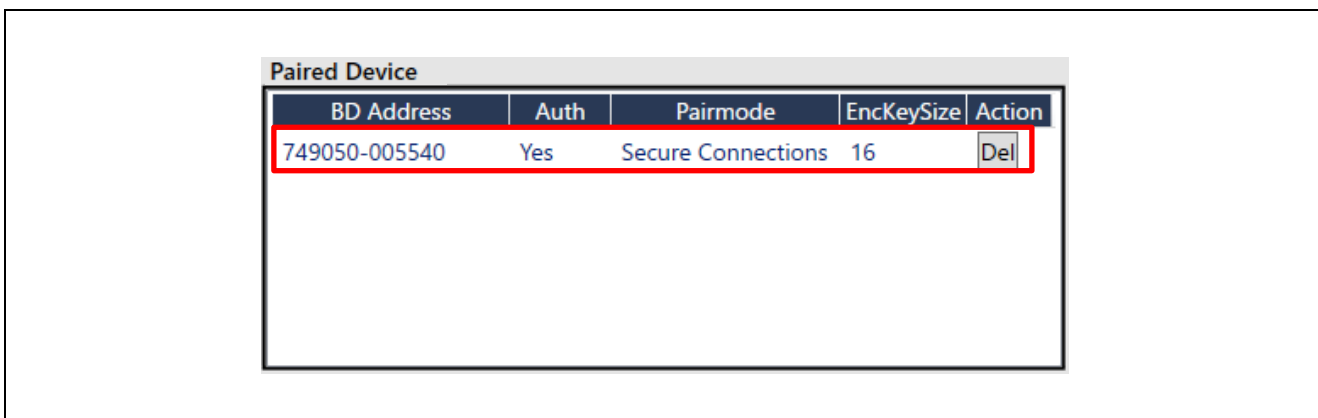

Figure 7-56. "Paired Device" list display

Note: If you delete only the pairing information on the slave side, you will not be able to reconnect to the master side. To reconnect, please delete the master side pairing information.

7.4.3 Save / Load of the Pairing Information

The pairing information displayed in the "Paired Device" list can be saved in the bonding information file. Also, by loading from the bonding information file, the pairing information can be reset to the MCU. These operations can be performed after successful connection with "3.3 The EVB connection and disconnection".

- Save the pairing information
Select "Bonding information" → "Save" from the "File" menu to save the pairing information to the bonding information file.

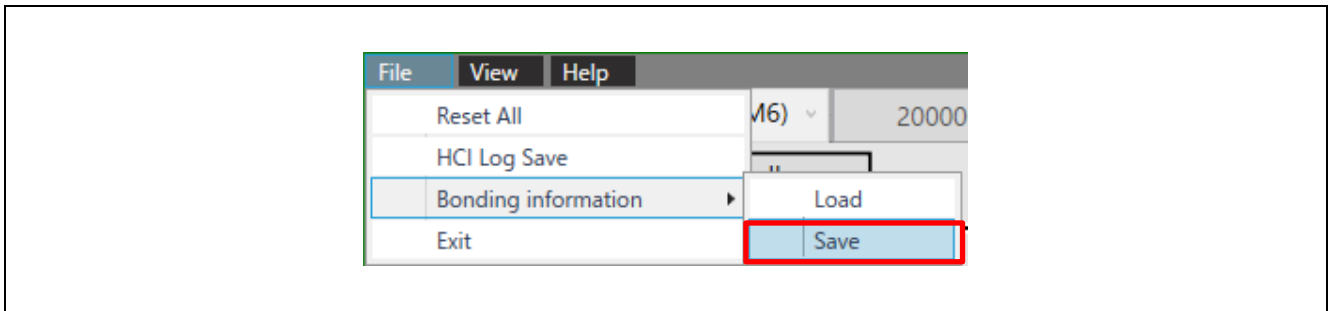

Figure 7-57. Bonding information save menu

"Save Bonding Information" dialog will be displayed. Please save by specifying any file name. The file is saved with the name "(specified file name).bondinf".

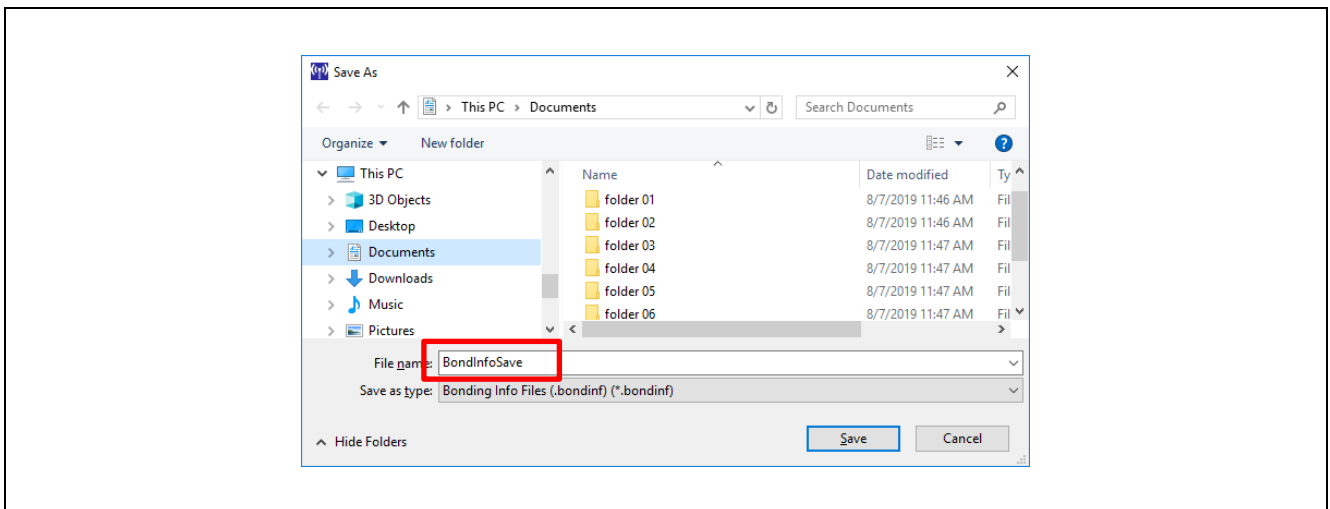

Figure 7-58. Bonding information save dialog (file name specification example)

- Loading pairing information
 Select "Bonding information" → "Load" from the "File" menu to load the pairing information from the bonding information file.

Note: All pairing information displayed in the "Paired Device" list before loading are cleared.

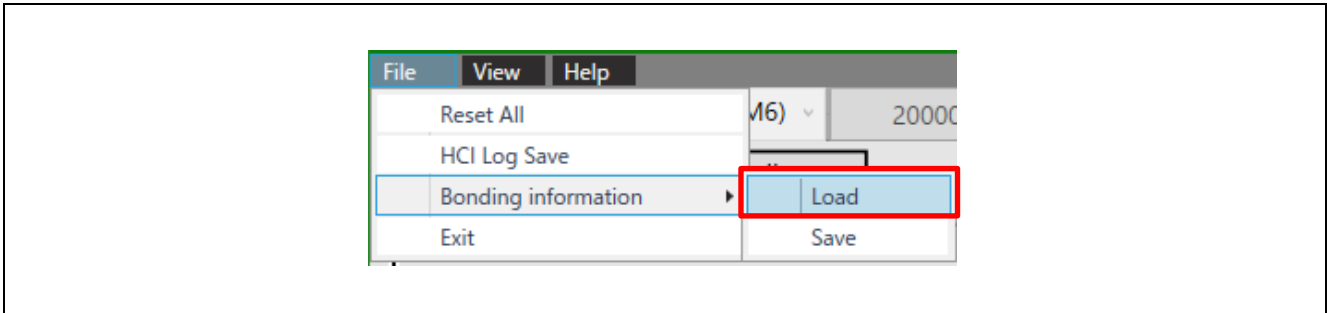

Figure 7-59. Bonding information load menu

The "Load bonding information" dialog will be displayed. Select the saved bonding information file. The "Paired Device" list is reconfigured with the contents of the selected file.

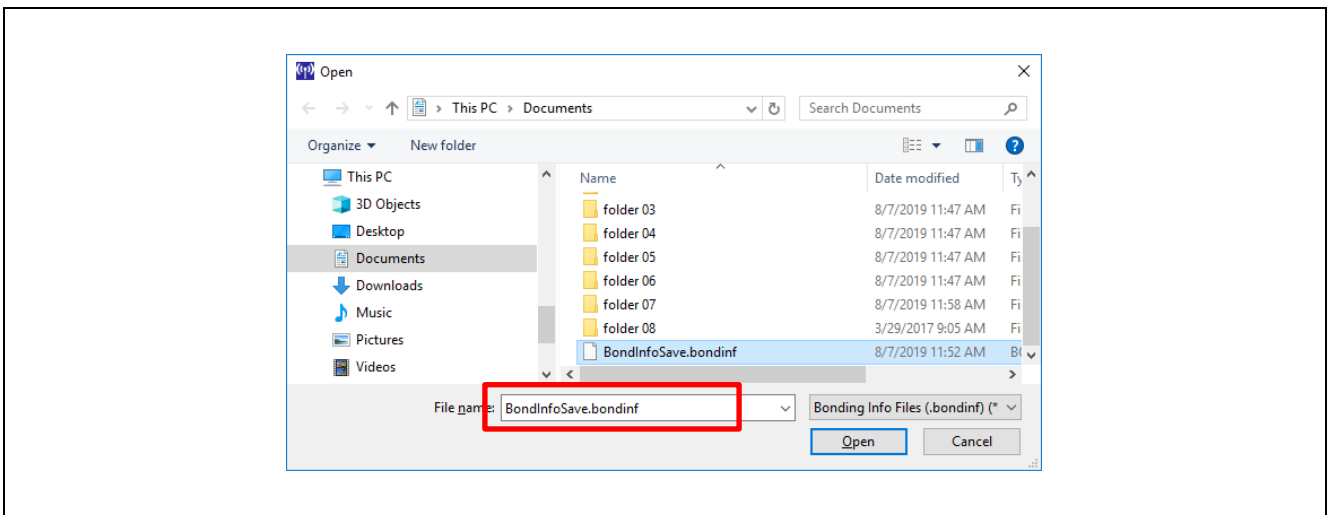

Figure 7-60. Bonding information load dialog

Device pairing information is stored in the following format in the bonding information file. The first line "BTTS bonding info file" is a character string that identifies the bonding information file. Files without this string are not identified as bonding information files. From the second line onwards, pairing information of each device is stored for each line.

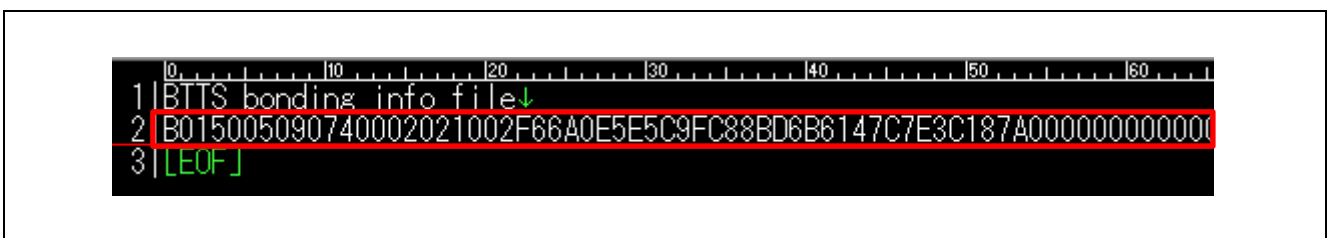

Figure 7-61. Bonding information file storage example

Pairing information is stored in the format shown in Table 7-3 and 1 byte is express by 2 characters.

Table 7-3. Pairing information format

Byte index	Byte size	Item contents
0	6	BD address of peer device
6	1	BD address type of peer device
7	1	Security level (Unauthenticated / Authenticated)
8	1	Pairing mode (Legacy / Secure)
9	1	Key size
10	1	Key type (bit0: LTK / bit1: IRK / bit2: CSRK)
11	16	LTK
27	10	EDIV / Rand
37	16	IRK
53	7	Identity address
60	16	CSRK

Note: The pairing information is security information, so handle it with care.







8. Use BTTS in the Radio Law Certification Test

This chapter describes how to execute BTTS for each radio law certification test item.

Use the SMA connector to connect the device under test to the measuring instrument of the certification body. Make sure that the SMA connector can be connected from the end of the antenna.

Table 8-1 describes the test items, the execution operations, and the BTTS tools to use.

Table 8-1. The test items, the execution operations, and the BTTS tools to use

Test item	Execution operation	BTTS tool
Frequency variation	8.1 CW (non-modulated continuous wave) Transmission	RF Evaluation tool 
Occupied bandwidth with and without spectrum spreading	8.2 Continuous Transmission of a Pseudo-Random Bit Sequence	RF Evaluation tool 
Intensity of spurious or unwanted emission	8.2 Continuous Transmission of a Pseudo-Random Bit Sequence	RF Evaluation tool 
Variation of antenna power	8.2 Continuous Transmission of a Pseudo-Random Bit Sequence	RF Evaluation tool 
Intensity of radio fields such as secondarily generated radio waves	8.3 Reception	RF Evaluation tool 
Functions for preventing interference (between identifying codes)	8.4 Scanning (*1)	Beacon tool  

*1 : Confirming the BD address of the opposite device (Opposing device performs advertising)

8.1 CW (non-modulated continuous wave) Transmission

1. Select "RF Evaluation" in the tool launcher to start the RF evaluation tool. Connect the EVB according to the procedure described in 3.3.
2. Click the "Transmit Test" of the upper part tab and select the "Continuous Wave Transmit" radio button.
3. Select the non-modulated wave "Modulation Disable" with the pull-down menu below the radio button.
4. Select "Middle" as the transmission power with the "Transmit Power" pull-down menu.
5. Select "1M" or "2M" as the transmission PHY with the "PHY" pull-down menu.
6. Select the transmission frequency channel with the "Transmit Frequency" pull-down menu.
Low: 2402MHz (RF-Ch.00), Middle: 2440MHz (RF-Ch.19), High: 2480MHz (RF-Ch.39)
7. Click the "▶START" button to start CW transmission.
8. Click the "■STOP" button to stop transmission.
To change the PHY, perform steps 5 through 8. To change the frequency, perform steps 6 through 8.

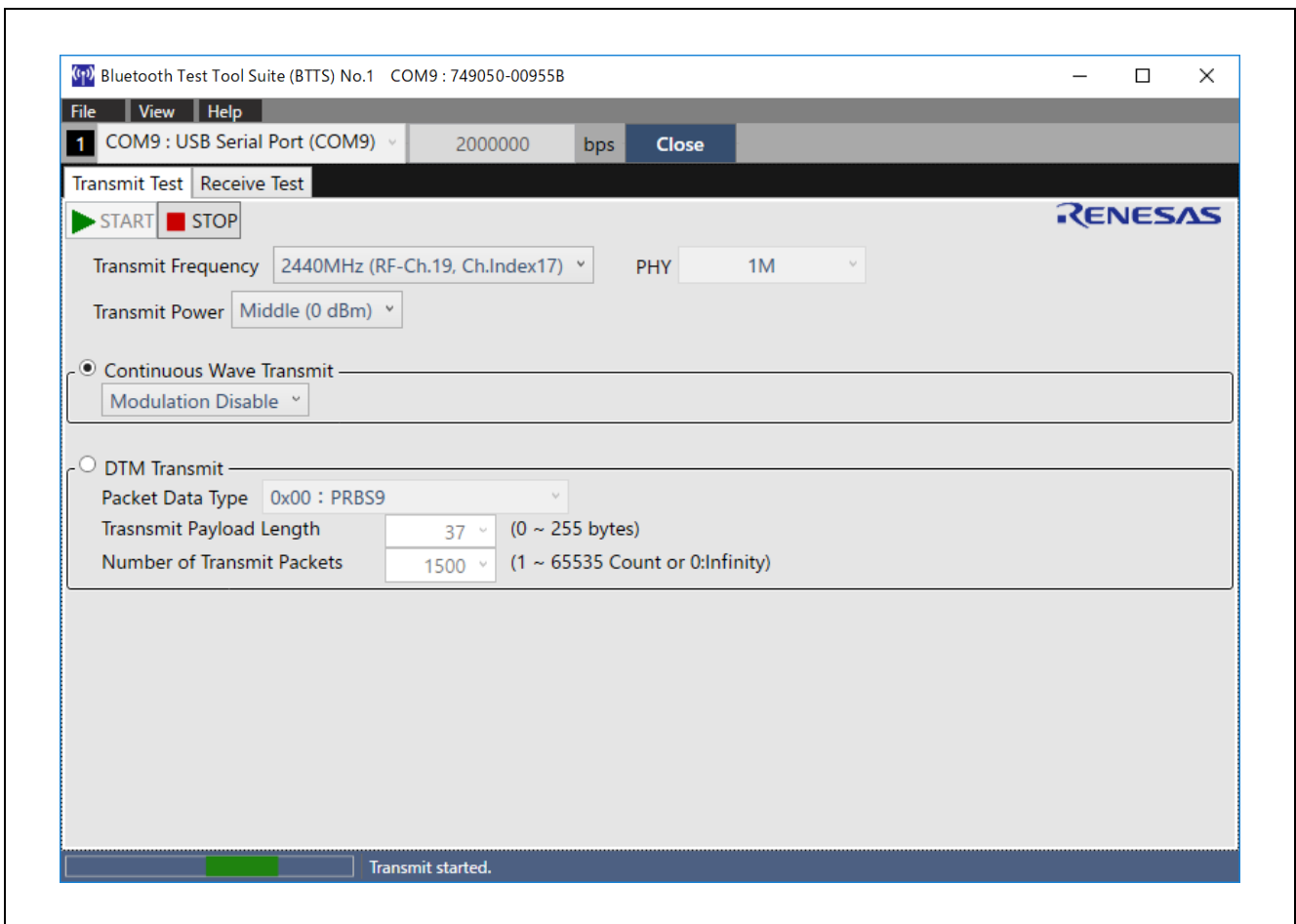

Figure 8-1. CW transmission settings

8.2 Continuous Transmission of a Pseudo-Random Bit Sequence

1. Select "RF Evaluation" in the tool launcher to start the RF evaluation tool. Connect the EVB according to the procedure described in 3.3.
2. Click the "Transmit Test" of the upper part tab and select the "DTM Transmit" radio button.
3. Select the pseudo-random number "0x00: PRBS9" (pseudo-random bit sequence with period 2^9-1) with the pull-down menu below the radio button.
Select "0" (Infinity) with the "Number of Transmit Packets" pull-down menu.
4. Select "Middle" as the transmission power with the "Transmit Power" pull-down menu.
Select "Low" or "High" when performing the "Antenna Power Deviation" test.
5. Select "1M" or "2M" as the transmission PHY with the "PHY" pull-down menu.
6. Select the transmission frequency channel with the "Transmit Frequency" pull-down menu.
Low: 2402MHz (RF-Ch.00), Middle: 2440MHz (RF-Ch.19), High: 2480MHz (RF-Ch.39)
7. Click the "▶START" button to start continuous transmission of pseudo-random numbers.
8. Click the "■STOP" button to stop continuous transmission.
To change the PHY, perform steps 5 through 8. To change the frequency, perform steps 6 through 8.

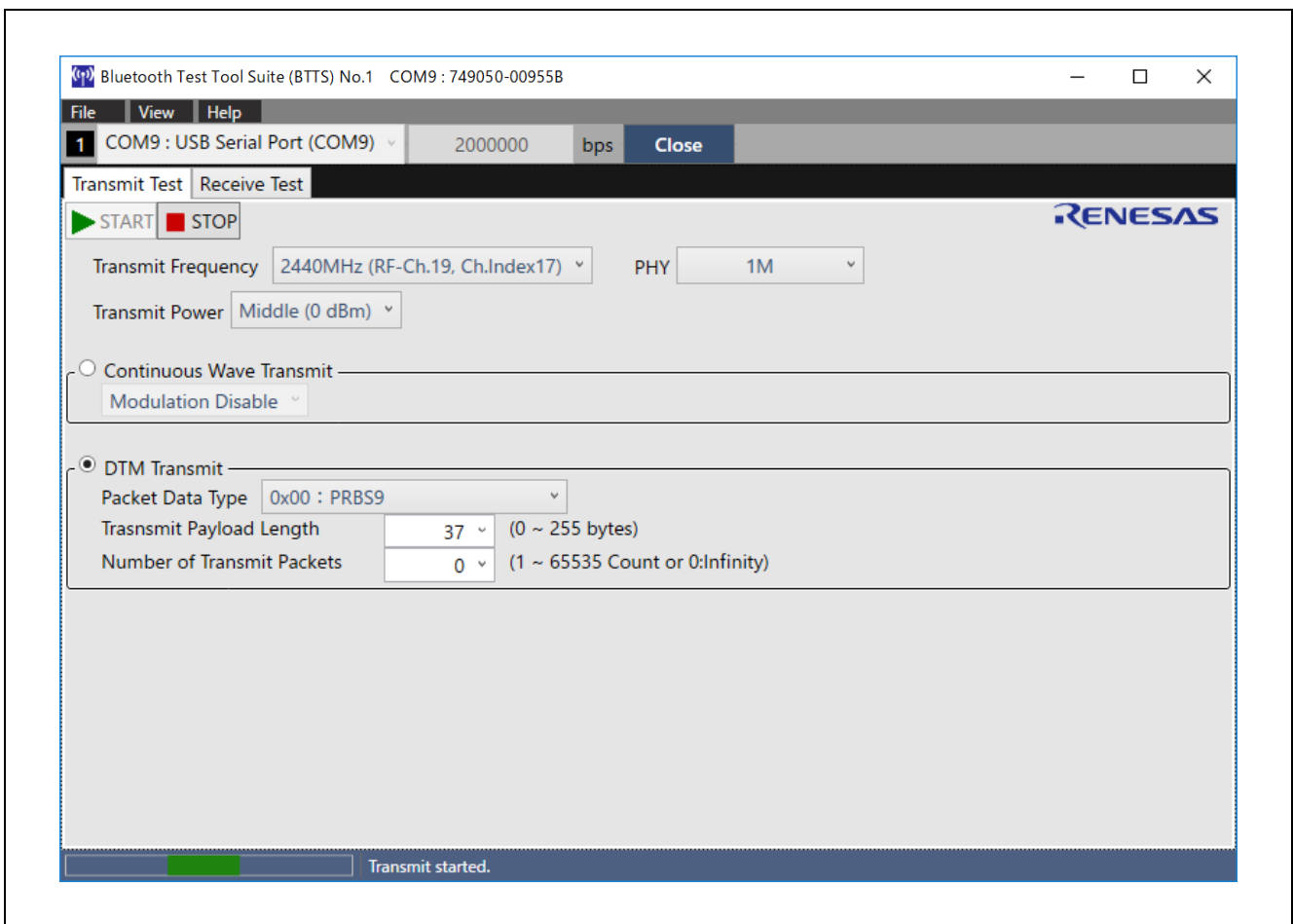

Figure 8-2. Pseudo random number continuous transmission setting

8.3 Reception

1. Select "RF Evaluation" in the tool launcher to start the RF evaluation tool. Connect the EVB according to the procedure described in 3.3.
2. Click the "Receive Test".
3. Select "0" (Infinity) with the "Expected Packet Counts" pull-down menu.
4. Select "1M" or "2M" as the receive PHY with the "PHY" pull-down menu.
5. Select the receive frequency channel with the "Receive Frequency" pull-down menu.
Low: 2402MHz (RF-Ch.00), Middle: 2440MHz (RF-Ch.19), High: 2480MHz (RF-Ch.39)
6. Click the "▶START" button to start receiving operation.
7. Click the "■STOP" button to stop receiving operation.
To change the PHY, perform steps 4 through 7. To change the frequency, perform steps 5 through 7.

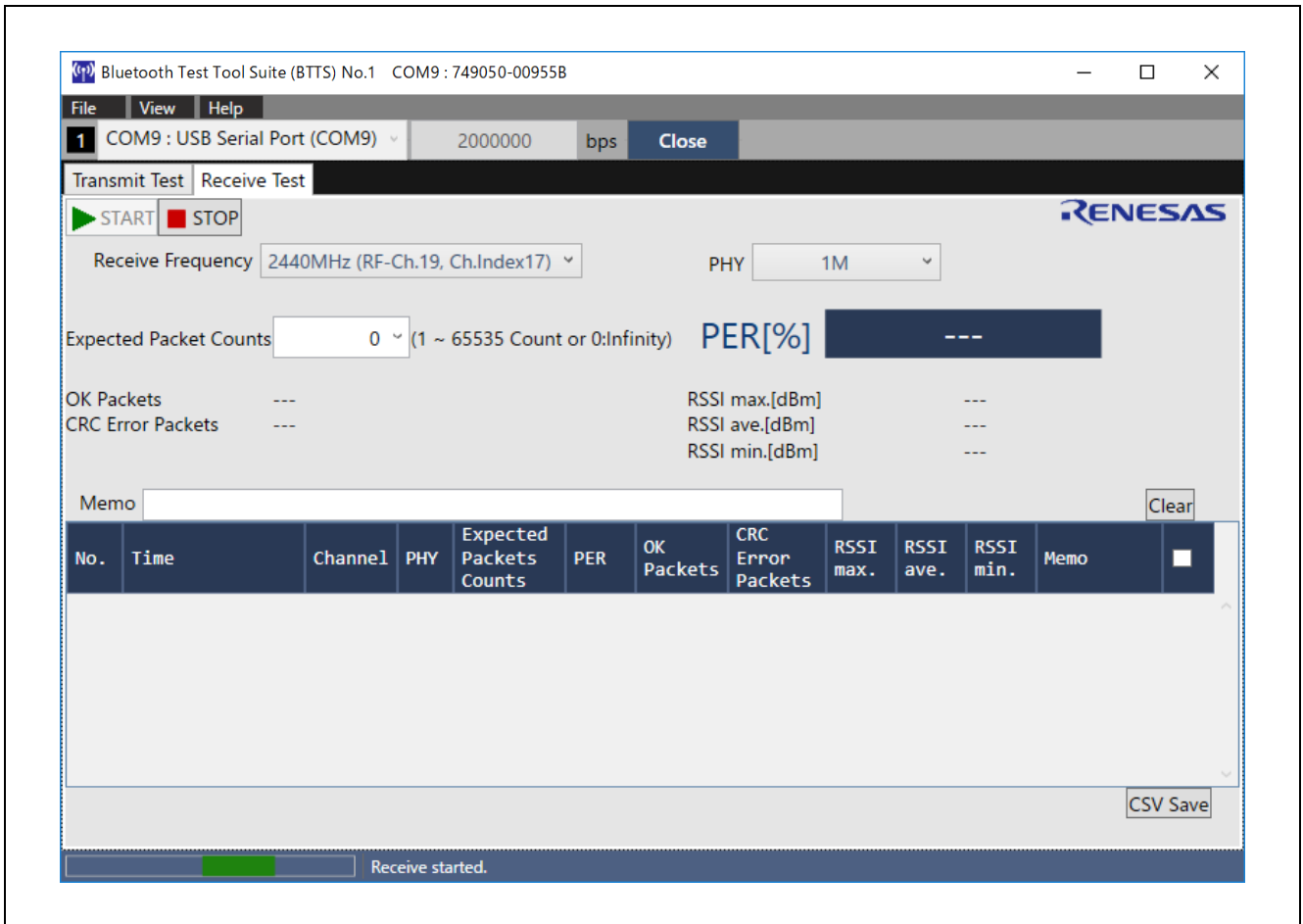

Figure 8-3. Receive operation setting

8.4 Scanning

8.4.1 Execute Advertising

To perform scanning on the receiving device side, first execute advertising on the opposite device side.

1. Select "Beacon Advertising" in the tool launcher to start the beacon advertising tool. Connect the EVB according to the procedure described in 3.3.
2. Check the checkbox on the "Handle #0" tab at the top.
3. Check the "Public" radio button in the "Advertising Address" frame.
4. Enter "0000A0" in the "Advertising Interval" text box and set the advertising interval to 100 msec. (Can be changed to any interval)
5. Check the "Legacy" radio button in the "Data Packet Length" frame.
6. Check the checkbox for all channels in "Advertising Channel".
7. Select "Local Name" from the "Advertising Data" pull-down menu, and enter an arbitrary device name in the text box.
8. Click the "▶START" button to start advertising.
9. After the test is complete, click the "■STOP" button to stop advertising.

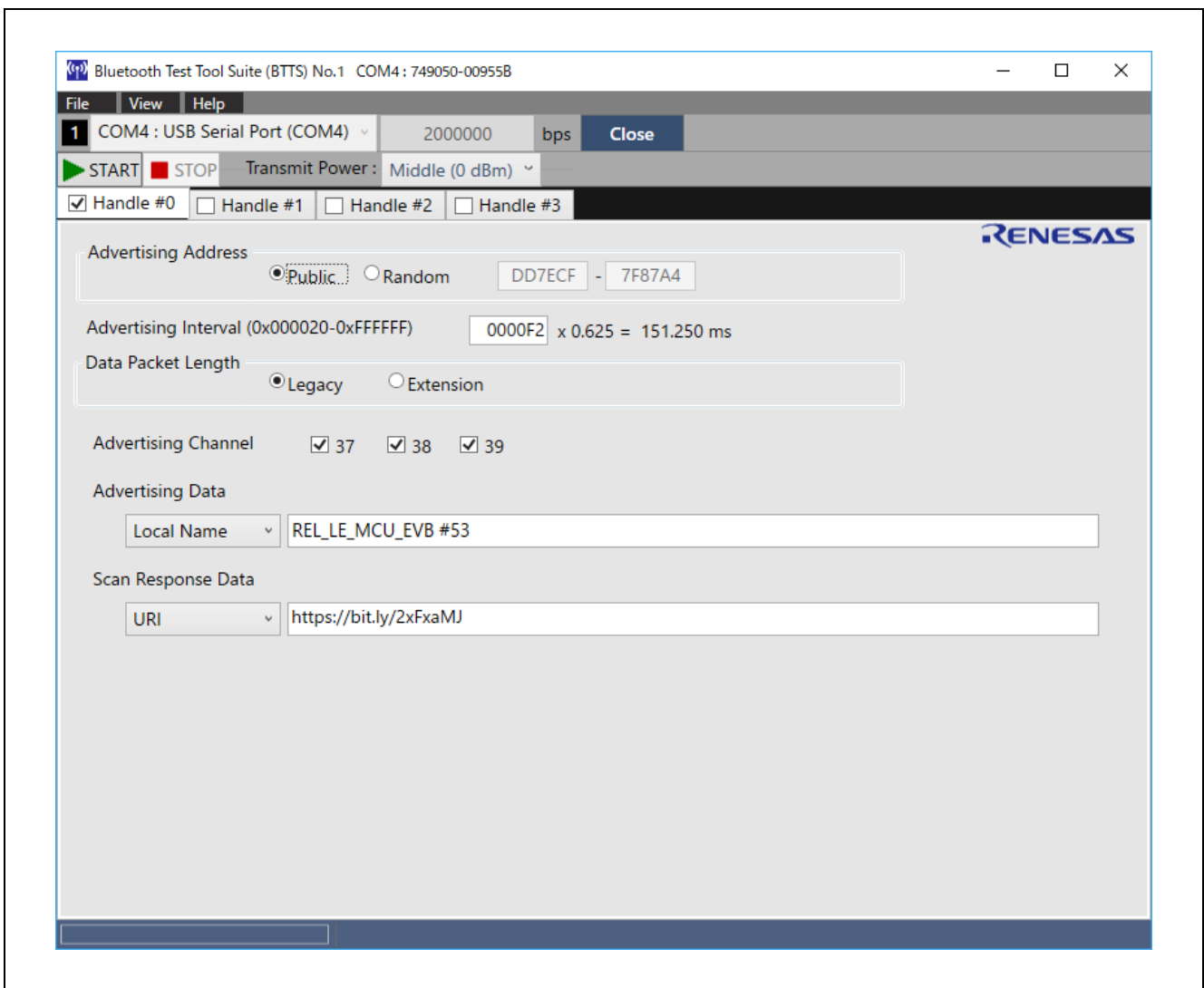

Figure 8-4. Advertising setting (opposite device side)

8.4.2 Execute Scanning

The receiving device side performs scanning.

1. Select "Beacon Scanning" in the tool launcher to start the beacon scanning tool. Connect the EVB according to the procedure described in 3.3.
2. Check the "Passive" radio button in the "Scanning Mode" frame.
3. Check the "Normal Range (1M PHY)" check button.
4. Enter "0640" in the "Interval" text box and "0640" in the "Window" text box to set the scanning duty cycle to 100%. (Can be changed to any value)
5. Depending on the environment of the surrounding advertiser, enable the filter function according to the procedure described in 6.2.3.
6. Click the "▶START" button to start scanning.
7. Confirm that the information of the opposite device is displayed in the "Scanning Result:" data grid.
8. After the test is complete, click the "■STOP" button to stop scanning.

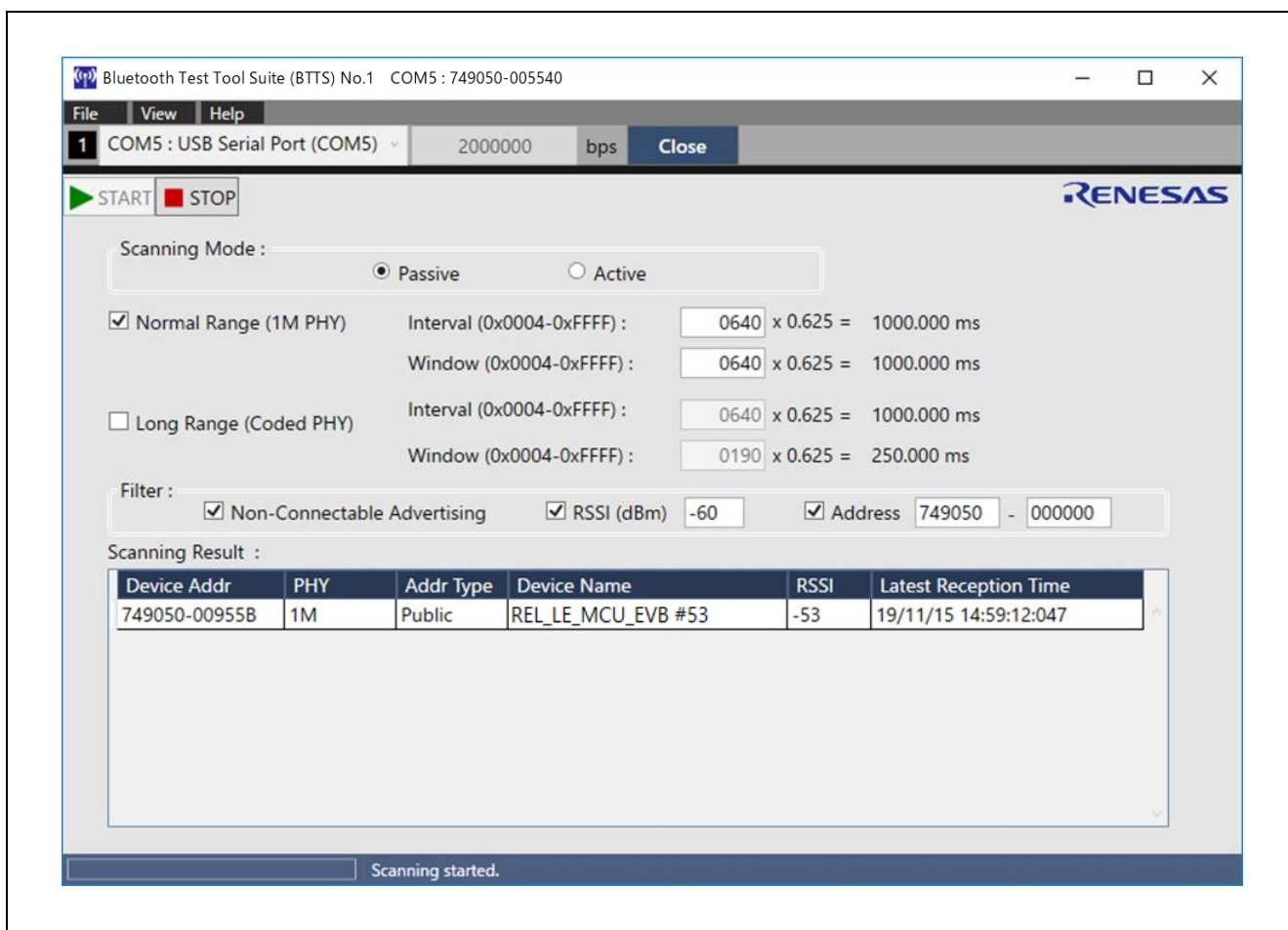

Figure 8-5. Scanning setting (receiving device side)

Revision History

Rev.	Date	Description	
		Page	Summary
1.00	Dec.29.22	—	First edition issued
1.01	Nov.28.19	—	<ul style="list-style-type: none"> • Added / changed descriptions and replaced image data related to the following updates of BTTS 1.01 <ul style="list-style-type: none"> — "Beacon Advertising" tool <ul style="list-style-type: none"> • Change the initial value of "Advertising Interval", "Periodic Advertising Interval" — "Beacon Scanning" tool <ul style="list-style-type: none"> • Added "RSSI (dBm) Filter" to filter settings — "Data Comm Slave" tool <ul style="list-style-type: none"> • Swap the positions of "Notification" and "Indication" radio buttons in the throughput measurement window — "Data Comm Master / Slave" tool <ul style="list-style-type: none"> • Removed bonding setting radio button in data communication window • Changed the list name of the data communication window from "Bonded Device" to "Paired Device" • Changed the number of devices that can be registered to the "Paired Device" list to 7 • Enabled setting change for the second and subsequent times of the "RF Setting" in the throughput measurement window • 8.1 to 8.3 Execution action <ul style="list-style-type: none"> — Added PHY change operation
1.02	Dec.20.19	—	<ul style="list-style-type: none"> • Tool name change (From "Bluetooth Trial Tool Suite" to "Bluetooth Test Tool Suite") and related image data replacement. • The changes from BTTS 1.01 are as follows. <ul style="list-style-type: none"> — "Data Comm Master / Slave" tools <ul style="list-style-type: none"> • Added flow control processing using BLE_VS_EVENT_TX_FLOW_STATE_CHG event when transmitting data • Changed the target of throughput calculation from ATT-MTU size to PDU payload size
1.03	May.07.20	—	<ul style="list-style-type: none"> • Document title change From "RX23W Group" to "Bluetooth Low Energy MCU". • Add the RA4W1 Group to Target Device Changed "RX23W" to "BLE MCU" and "TB" to "EVB" in the document according to the addition of target devices. • Added "EK-RA4W1" to Figure 1-1 • 1.4 Operational Environment <ul style="list-style-type: none"> — EK-RA4W1 added to EVB — RA4W1 Group User's Manual Information Addition • Figure 2-1 Replacement • 3.1.1 Write HCI mode firmware Protocol stack manual information addition for RA4W1 • The changes from BTTS 1.02 are as follows <ul style="list-style-type: none"> — Change the initial value of the connection interval of the "Data Comm" tool to 0x14 (25ms) — Added UUID (128 bit) data of "Throughput Service" to advertising data of "Data Comm Slave" tool
1.04	Mar.01.21	7	<ul style="list-style-type: none"> • Figure 2-1 Replacement

Rev.	Date	Description	
		Page	Summary
		9 29 40 46 47 56 58 59 62 61 64	<ul style="list-style-type: none"> • HCI mode firmware version-up for the RX23W EVB • Added description when the public address is invalid to 3.1.1 • Added description about that Static address is used when "Random" radio button is selected to 6.1.4 • Figure 6-6 Replacement • Figure 7-1 Replacement • Added description about that the maximum value of ATT_MTU can be entered directly in the text box to 7.2.1 • Figure 7-13, Figure 7-14 Replacement • Added description about that the maximum value of ATT_MTU can be entered directly in the text box to 7.3.1 • Figure 7-35 Replacement • Change the method of the pairing key (IRK) setting • Figure 7-39 Replacement • Added description about privacy type to BD address type setting • Changed the display of radio buttons and pull-down menus related to BD address type settings • Figure 7-41 Replacement • Removed note about when IRK is not distributed from smartphone • Figure 7-46, Figure 7-47 Replacement • Change the method of the pairing key (IRK) setting • Figure 7-51 Replacement • Added description about privacy type to BD address type setting • Changed the display of radio buttons and pull-down menus related to BD address type settings • Figure 7-53 Replacement
1.05	May.20.21	— 1 4 4 5 7 9 59, 64	<ul style="list-style-type: none"> • Changed "BLE" notation to "Bluetooth LE" • Changed "BLE MCU" notation to "MCU" • Added RE01B group to target device • Added EB-RE01B to Figure 1-1 • Added MCU document information for RE01B • Added EVB for RE01B to 1.4 • Added RE01B user's manual information • Figure 2-1 Replacement • Added RE01B documentation information and Note to 3.1.1 • Non-RPA is mainly used for connectionless communication, so it changed to non-selectable at Privacy type
1.06	Mar.10.22	7 30 exe	<ul style="list-style-type: none"> • Updated HCI firmware for RX23W and RE01B • Set a link to the specification document in "Assigned Numbers / Generic Access Profile" • Fixed a problem where the wrong remote BD address type would be set in the bonding information when connecting to a remote device that uses Resolvable Private Address (RPA)
1.07	Dec.29.22	39 42,43 exe	<ul style="list-style-type: none"> • Added "Name" information to Service definition. • Change the screen and description of GATTBrowser. • Fixed an issue where incorrect privacy mode was set when remote device uses RPA.

General Precautions in the Handling of Microprocessing Unit and Microcontroller Unit Products

The following usage notes are applicable to all Microprocessing unit and Microcontroller unit products from Renesas. For detailed usage notes on the products covered by this document, refer to the relevant sections of the document as well as any technical updates that have been issued for the products.

1. Precaution against Electrostatic Discharge (ESD)

A strong electrical field, when exposed to a CMOS device, can cause destruction of the gate oxide and ultimately degrade the device operation. Steps must be taken to stop the generation of static electricity as much as possible, and quickly dissipate it when it occurs. Environmental control must be adequate. When it is dry, a humidifier should be used. This is recommended to avoid using insulators that can easily build up static electricity.

Semiconductor devices must be stored and transported in an anti-static container, static shielding bag or conductive material. All test and measurement tools including work benches and floors must be grounded. The operator must also be grounded using a wrist strap. Semiconductor devices must not be touched with bare hands. Similar precautions must be taken for printed circuit boards with mounted semiconductor devices.

2. Processing at power-on

The state of the product is undefined at the time when power is supplied. The states of internal circuits in the LSI are indeterminate and the states of register settings and pins are undefined at the time when power is supplied. In a finished product where the reset signal is applied to the external reset pin, the states of pins are not guaranteed from the time when power is supplied until the reset process is completed. In a similar way, the states of pins in a product that is reset by an on-chip power-on reset function are not guaranteed from the time when power is supplied until the power reaches the level at which resetting is specified.

3. Input of signal during power-off state

Do not input signals or an I/O pull-up power supply while the device is powered off. The current injection that results from input of such a signal or I/O pull-up power supply may cause malfunction and the abnormal current that passes in the device at this time may cause degradation of internal elements. Follow the guideline for input signal during power-off state as described in your product documentation.

4. Handling of unused pins

Handle unused pins in accordance with the directions given under handling of unused pins in the manual. The input pins of CMOS products are generally in the high-impedance state. In operation with an unused pin in the open-circuit state, extra electromagnetic noise is induced in the vicinity of the LSI, an associated shoot-through current flows internally, and malfunctions occur due to the false recognition of the pin state as an input signal become possible.

5. Clock signals

After applying a reset, only release the reset line after the operating clock signal becomes stable. When switching the clock signal during program execution, wait until the target clock signal is stabilized. When the clock signal is generated with an external resonator or from an external oscillator during a reset, ensure that the reset line is only released after full stabilization of the clock signal. Additionally, when switching to a clock signal produced with an external resonator or by an external oscillator while program execution is in progress, wait until the target clock signal is stable.

6. Voltage application waveform at input pin

Waveform distortion due to input noise or a reflected wave may cause malfunction. If the input of the CMOS device stays in the area between V_{IL} (Max.) and V_{IH} (Min.) due to noise, for example, the device may malfunction. Take care to prevent chattering noise from entering the device when the input level is fixed, and also in the transition period when the input level passes through the area between V_{IL} (Max.) and V_{IH} (Min.).

7. Prohibition of access to reserved addresses

Access to reserved addresses is prohibited. The reserved addresses are provided for possible future expansion of functions. Do not access these addresses as the correct operation of the LSI is not guaranteed.

8. Differences between products

Before changing from one product to another, for example to a product with a different part number, confirm that the change will not lead to problems. The characteristics of a microprocessing unit or microcontroller unit products in the same group but having a different part number might differ in terms of internal memory capacity, layout pattern, and other factors, which can affect the ranges of electrical characteristics, such as characteristic values, operating margins, immunity to noise, and amount of radiated noise. When changing to a product with a different part number, implement a system-evaluation test for the given product.

Notice

1. Descriptions of circuits, software and other related information in this document are provided only to illustrate the operation of semiconductor products and application examples. You are fully responsible for the incorporation or any other use of the circuits, software, and information in the design of your product or system. Renesas Electronics disclaims any and all liability for any losses and damages incurred by you or third parties arising from the use of these circuits, software, or information.
2. Renesas Electronics hereby expressly disclaims any warranties against and liability for infringement or any other claims involving patents, copyrights, or other intellectual property rights of third parties, by or arising from the use of Renesas Electronics products or technical information described in this document, including but not limited to, the product data, drawings, charts, programs, algorithms, and application examples.
3. No license, express, implied or otherwise, is granted hereby under any patents, copyrights or other intellectual property rights of Renesas Electronics or others.
4. You shall be responsible for determining what licenses are required from any third parties, and obtaining such licenses for the lawful import, export, manufacture, sales, utilization, distribution or other disposal of any products incorporating Renesas Electronics products, if required.
5. You shall not alter, modify, copy, or reverse engineer any Renesas Electronics product, whether in whole or in part. Renesas Electronics disclaims any and all liability for any losses or damages incurred by you or third parties arising from such alteration, modification, copying or reverse engineering.
6. Renesas Electronics products are classified according to the following two quality grades: "Standard" and "High Quality". The intended applications for each Renesas Electronics product depends on the product's quality grade, as indicated below.
 - "Standard": Computers; office equipment; communications equipment; test and measurement equipment; audio and visual equipment; home electronic appliances; machine tools; personal electronic equipment; industrial robots; etc.
 - "High Quality": Transportation equipment (automobiles, trains, ships, etc.); traffic control (traffic lights); large-scale communication equipment; key financial terminal systems; safety control equipment; etc.

Unless expressly designated as a high reliability product or a product for harsh environments in a Renesas Electronics data sheet or other Renesas Electronics document, Renesas Electronics products are not intended or authorized for use in products or systems that may pose a direct threat to human life or bodily injury (artificial life support devices or systems; surgical implantations; etc.), or may cause serious property damage (space system; undersea repeaters; nuclear power control systems; aircraft control systems; key plant systems; military equipment; etc.). Renesas Electronics disclaims any and all liability for any damages or losses incurred by you or any third parties arising from the use of any Renesas Electronics product that is inconsistent with any Renesas Electronics data sheet, user's manual or other Renesas Electronics document.
7. No semiconductor product is absolutely secure. Notwithstanding any security measures or features that may be implemented in Renesas Electronics hardware or software products, Renesas Electronics shall have absolutely no liability arising out of any vulnerability or security breach, including but not limited to any unauthorized access to or use of a Renesas Electronics product or a system that uses a Renesas Electronics product. RENESAS ELECTRONICS DOES NOT WARRANT OR GUARANTEE THAT RENESAS ELECTRONICS PRODUCTS, OR ANY SYSTEMS CREATED USING RENESAS ELECTRONICS PRODUCTS WILL BE INVULNERABLE OR FREE FROM CORRUPTION, ATTACK, VIRUSES, INTERFERENCE, HACKING, DATA LOSS OR THEFT, OR OTHER SECURITY INTRUSION ("Vulnerability Issues"). RENESAS ELECTRONICS DISCLAIMS ANY AND ALL RESPONSIBILITY OR LIABILITY ARISING FROM OR RELATED TO ANY VULNERABILITY ISSUES. FURTHERMORE, TO THE EXTENT PERMITTED BY APPLICABLE LAW, RENESAS ELECTRONICS DISCLAIMS ANY AND ALL WARRANTIES, EXPRESS OR IMPLIED, WITH RESPECT TO THIS DOCUMENT AND ANY RELATED OR ACCOMPANYING SOFTWARE OR HARDWARE, INCLUDING BUT NOT LIMITED TO THE IMPLIED WARRANTIES OF MERCHANTABILITY, OR FITNESS FOR A PARTICULAR PURPOSE.
8. When using Renesas Electronics products, refer to the latest product information (data sheets, user's manuals, application notes, "General Notes for Handling and Using Semiconductor Devices" in the reliability handbook, etc.), and ensure that usage conditions are within the ranges specified by Renesas Electronics with respect to maximum ratings, operating power supply voltage range, heat dissipation characteristics, installation, etc. Renesas Electronics disclaims any and all liability for any malfunctions, failure or accident arising out of the use of Renesas Electronics products outside of such specified ranges.
9. Although Renesas Electronics endeavors to improve the quality and reliability of Renesas Electronics products, semiconductor products have specific characteristics, such as the occurrence of failure at a certain rate and malfunctions under certain use conditions. Unless designated as a high reliability product or a product for harsh environments in a Renesas Electronics data sheet or other Renesas Electronics document, Renesas Electronics products are not subject to radiation resistance design. You are responsible for implementing safety measures to guard against the possibility of bodily injury, injury or damage caused by fire, and/or danger to the public in the event of a failure or malfunction of Renesas Electronics products, such as safety design for hardware and software, including but not limited to redundancy, fire control and malfunction prevention, appropriate treatment for aging degradation or any other appropriate measures. Because the evaluation of microcomputer software alone is very difficult and impractical, you are responsible for evaluating the safety of the final products or systems manufactured by you.
10. Please contact a Renesas Electronics sales office for details as to environmental matters such as the environmental compatibility of each Renesas Electronics product. You are responsible for carefully and sufficiently investigating applicable laws and regulations that regulate the inclusion or use of controlled substances, including without limitation, the EU RoHS Directive, and using Renesas Electronics products in compliance with all these applicable laws and regulations. Renesas Electronics disclaims any and all liability for damages or losses occurring as a result of your noncompliance with applicable laws and regulations.
11. Renesas Electronics products and technologies shall not be used for or incorporated into any products or systems whose manufacture, use, or sale is prohibited under any applicable domestic or foreign laws or regulations. You shall comply with any applicable export control laws and regulations promulgated and administered by the governments of any countries asserting jurisdiction over the parties or transactions.
12. It is the responsibility of the buyer or distributor of Renesas Electronics products, or any other party who distributes, disposes of, or otherwise sells or transfers the product to a third party, to notify such third party in advance of the contents and conditions set forth in this document.
13. This document shall not be reprinted, reproduced or duplicated in any form, in whole or in part, without prior written consent of Renesas Electronics.
14. Please contact a Renesas Electronics sales office if you have any questions regarding the information contained in this document or Renesas Electronics products.

(Note1) "Renesas Electronics" as used in this document means Renesas Electronics Corporation and also includes its directly or indirectly controlled subsidiaries.

(Note2) "Renesas Electronics product(s)" means any product developed or manufactured by or for Renesas Electronics.

(Rev.5.0-1 October 2020)

Corporate Headquarters

TOYOSU FORESIA, 3-2-24 Toyosu,
Koto-ku, Tokyo 135-0061, Japan
www.renesas.com

Trademarks

Renesas and the Renesas logo are trademarks of Renesas Electronics Corporation. All trademarks and registered trademarks are the property of their respective owners.

Contact information

For further information on a product, technology, the most up-to-date version of a document, or your nearest sales office, please visit:
www.renesas.com/contact/.