

# Application Note

## DA14531 Filter for Spurious Emissions Reduction

AN-B-073

### Abstract

*This document contains guidelines for implementing a RFIO filter to reduce conducted and radiated spurious emissions in Bluetooth low energy applications using Dialog's DA14531 System-on-Chip.*

---

**Contents**

**Abstract** ..... 1

**Contents** ..... 2

**Figures**..... 3

**Tables** ..... 3

**1 Terms and Definitions**..... 4

**2 References** ..... 4

**3 Introduction**..... 5

**4 Filter Configuration** ..... 5

    4.1 Pi Filter ..... 5

    4.2 Simulated Performance..... 6

    4.3 Measured Performance..... 6

**5 Conducted Performance**..... 7

    5.1 TX Measurements ..... 7

        5.1.1 Conducted Limits ..... 7

        5.1.2 Measurement Results..... 7

    5.2 RX Measurements ..... 8

        5.2.1 Conducted Limits ..... 8

        5.2.2 Measurement Results..... 8

**6 Radiated Performance** ..... 8

    6.1 TX Measurements ..... 10

    6.2 RX Measurements ..... 11

**7 Other Remarks**..... 11

    7.1 Impact on Power Consumption ..... 11

    7.2 Impact on Link Budget ..... 11

**8 Conclusions** ..... 12

**Revision History** ..... 13

## Figures

|   |    |
|---|----|
| Figure 1: Pi Filter Topology .....  | 5  |
| Figure 2: Transfer Function and Return Loss of Pi Filter .....                          | 6  |
| Figure 3: Measurement Results of the Pi-filter .....                                    | 7  |
| Figure 4: DUT on a Turning Table.....   | 8  |
| Figure 5: Experiment Setup for Measuring Radiated Performance .....                     | 9  |
| Figure 6: ETSI EN 300 328 - Transmitter Unwanted Emissions in the Spurious Domain ..... | 10 |
| Figure 7: Part 15.247 - Spurious Emissions Radiated at from 1 GHz to 18 GHz .....       | 10 |
| Figure 8: ETSI EN 300 328 - Receiver Spurious Emissions .....                           | 11 |
| Figure 9: Schematic of Example Implementation of Pi Filter to DA14531 .....             | 12 |

## Tables

|  |   |
|--|---|
| Table 1: Specification Limits for Conducted TX Measurements .....                | 7 |
| Table 2: Fundamental Power and Harmonics, Conducted Mode, PA in 3 dBm Mode ..... | 7 |
| Table 3: Specification Limits for Conducted RX Measurements .....                | 8 |
| Table 4: LO Leakage in Conducted Mode Results .....                              | 8 |

## 1 Terms and Definitions

|     |                          |
|-----|--------------------------|
| SoC | System on Chip           |
| BLE | Bluetooth Low Energy     |
| DUT | Device under Test        |
| SDK | Software Development Kit |

## 2 References

- [1] [UM-B-083](#), SmartSnippets™ Toolbox, User Manual, Dialog Semiconductor.
- [2] [UM-B-119](#), DA14585/DA14531 SW Platform Reference Manual, Dialog Semiconductor.

### 3 Introduction

This document provides information on implementing a 3-component Pi filter for Dialog's DA14531 System-on-Chip (SoC) in 2.4 GHz Bluetooth low energy (BLE) applications. It specifically addresses the conducted performance in the spurious domain.

### 4 Filter Configuration

A range of different filter configurations have been considered and assessed in terms of performances, costs, and sizes. The assessment concluded that the best configuration was a Pi filter. The Pi filter configuration was chosen because it gave the best harmonic suppression with minimal power loss at fundamental frequencies. Lower cost solutions were eliminated because they did not deliver the same level of suppression whilst having greater impact on power loss. The size of the components is not critical, but to implement a small footprint, filter 0201 components have been used.

#### 4.1 Pi Filter

The filter topology is shown in [Figure 1](#).

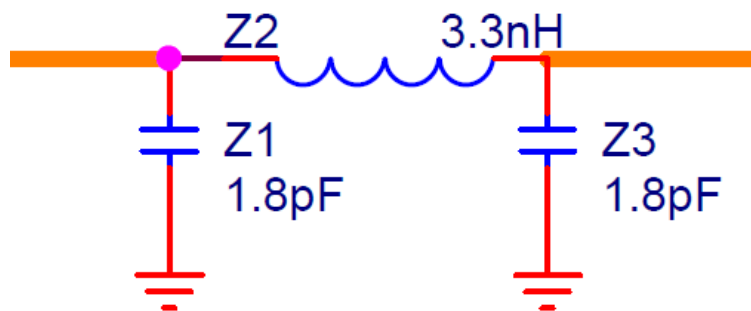

Figure 1: Pi Filter Topology

The components used include:

- Capacitors: 1.8 pF, 0201, Murata, PN: GRM0335C1H1R8CA01
- Inductor: 3.3 nH, 0201, Murata, PN: LQP03TN3N3B02

## 4.2 Simulated Performance

Transfer function and return loss are shown in Figure 2.

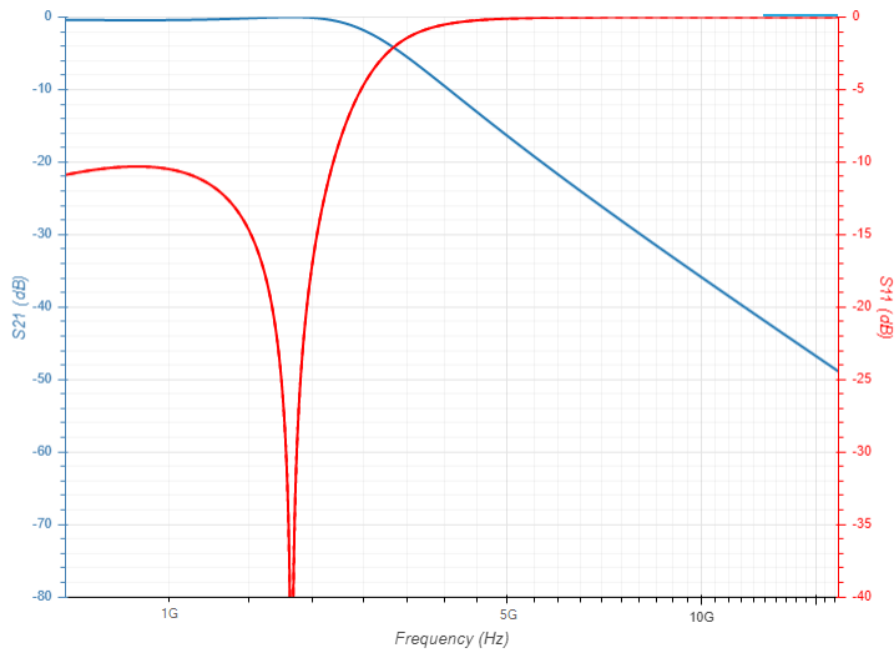

Figure 2: Transfer Function and Return Loss of Pi Filter

The simulated loss at fundamental power is ~0.35 dB while providing a second harmonic suppression of ~15 dB.

## 4.3 Measured Performance

The influence of the daughter board on the filter function was measured with a calibrated network analyzer connected via SMA connectors to the filter on the daughter board.

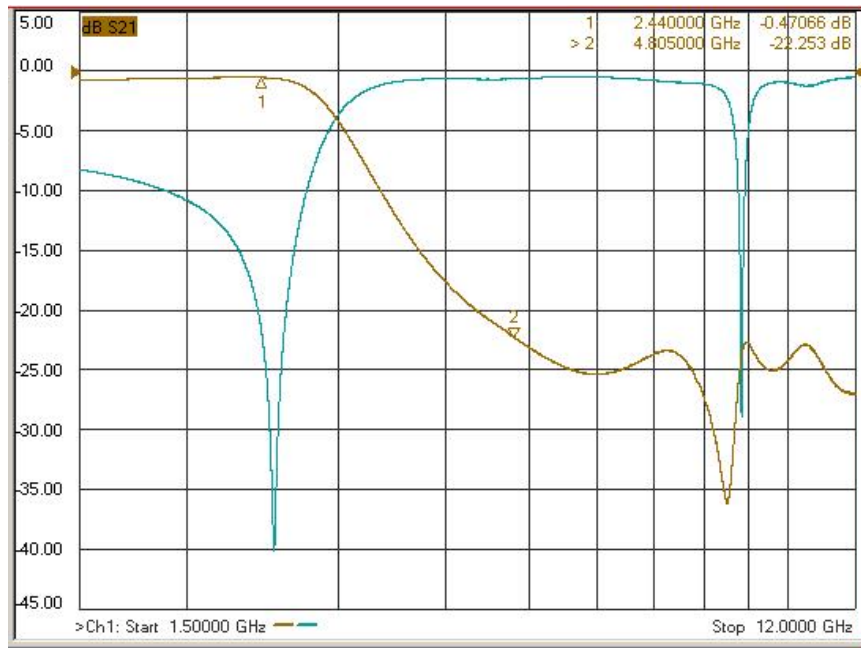

Figure 3: Measurement Results of the Pi-filter

## 5 Conducted Performance

The measurements are performed using a calibrated spectrum analyzer and RF cables. The levels are measured at the SMA output of the device under test (DUT). All measurements are calibrated for cable losses.

The production test software (`prod_test.hex`) from Dialog's DA14531 SDK is used to set the device into BLE TX and RX mode. This can be done with RF master of [SmartSnippets](#) Toolbox or with `prodtest.exe` using the commands "cont\_pkt\_tx" and "start\_pkt\_rx" (see [1] and [Appendix J](#) in [2]).

### 5.1 TX Measurements

#### 5.1.1 Conducted Limits

There are different limits specified for the conducted TX measurements. [Table 1](#) shows the limits for ETSI, FCC, and Japan.

Table 1: Specification Limits for Conducted TX Measurements

| Measurement  | ETSI    | FCC     | Japan   |
|--------------|---------|---------|---------|
| TX Conducted | -30 dBm | -20 dBc | -26 dBm |

#### 5.1.2 Measurement Results

The test is performed at 2402 MHz, room temperature, and normal operating conditions. Measurements are done in burst mode, modulated signal.

Table 2: Fundamental Power and Harmonics, Conducted Mode, PA in 3 dBm Mode

|                     | Fundamental | 2nd harm | 3rd harm | 4th harm | 5th harm |
|---------------------|-------------|----------|----------|----------|----------|
| Without RFIO filter | 2.2         | -40.16   | -40.75   | -47.58   | -39.26   |

|                  | Fundamental | 2nd harm | 3rd harm | 4th harm | 5th harm |
|------------------|-------------|----------|----------|----------|----------|
| With RFIO filter | 1.54        | -58.99   | -61.27   | -68.95   | -56.15   |

**Note 1** All values in dBm.

## 5.2 RX Measurements

### 5.2.1 Conducted Limits

Limits for the conducted RX measurements can be found in [Table 3](#).

**Table 3: Specification Limits for Conducted RX Measurements**

| Measurement  | ETSI    | Japan   | Korea   |
|--------------|---------|---------|---------|
| RX conducted | -47 dBm | -47 dBm | -54 dBm |

### 5.2.2 Measurement Results

The test is performed at 2402 MHz and the measurement frequency is 4805 MHz ( $2 \times 2402 + 1$  MHz).

**Table 4: LO Leakage in Conducted Mode Results**

| Measurement      | Without RFIO filter | With RFIO filter |
|------------------|---------------------|------------------|
| LO Leakage Power | -41.33 dBm          | -58.78 dBm       |

## 6 Radiated Performance

The measurements are performed in an anechoic chamber using a standard wideband horn antenna at the reference receiver. The DUT is placed on a turning table 3 meters away from the antenna. The measurements include the DUT board in horizontal and vertical position and both vertical and horizontal polarizations are measured. The maximum value is recorded.

All measurements are calibrated for antenna gain, amplifier gain, cable losses and path losses.

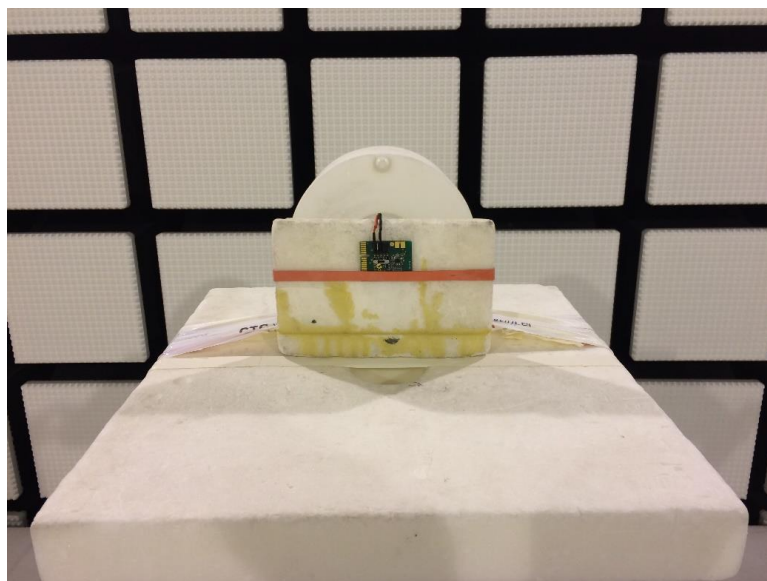

**Figure 4: DUT on a Turning Table**



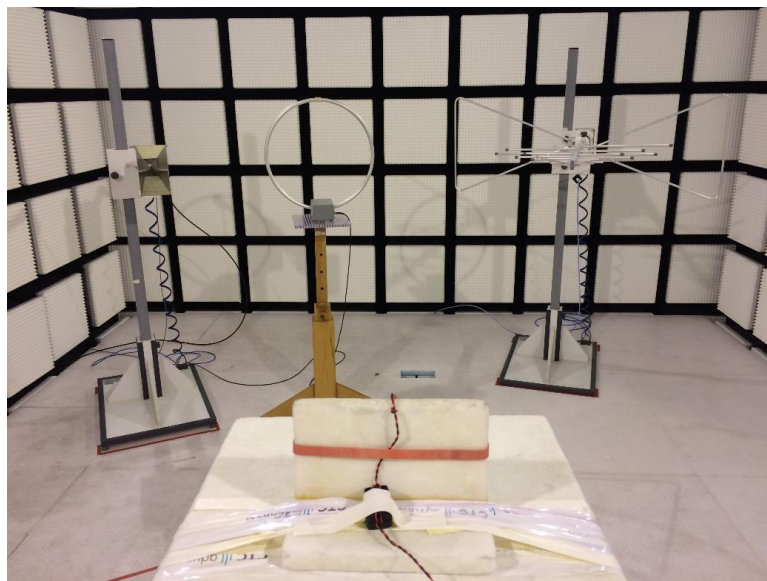

Figure 5: Experiment Setup for Measuring Radiated Performance

6.1 TX Measurements

The test is performed at 2402 MHz, room temperature, and normal operating conditions. The carrier signal is notched with a 2.4 GHz band rejection filter. The red lines in Figure 6 and Figure 7 indicate the specification limits. The DUT with the Pi filter has good margins towards the limits.

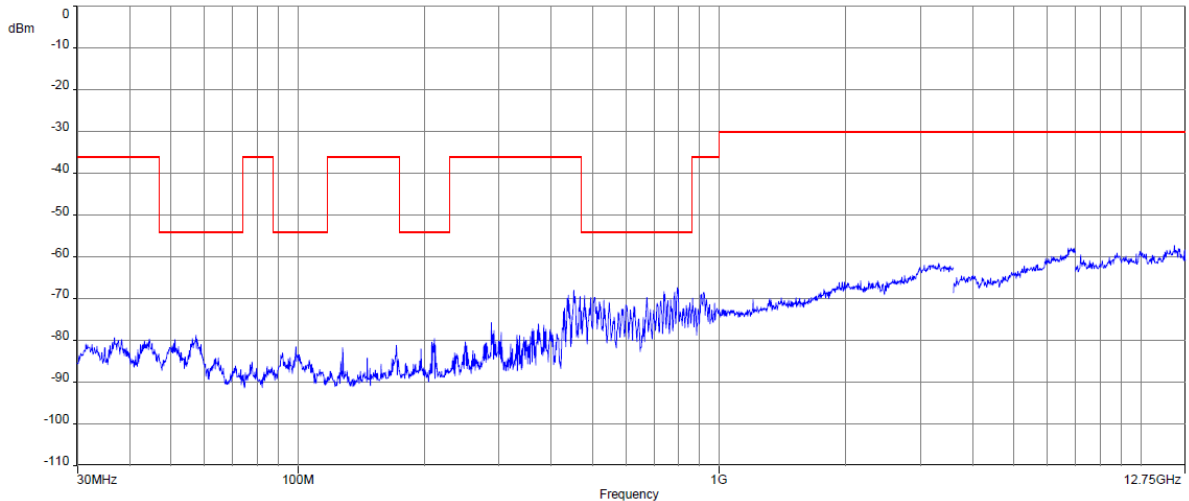

Figure 6: ETSI EN 300 328 - Transmitter Unwanted Emissions in the Spurious Domain

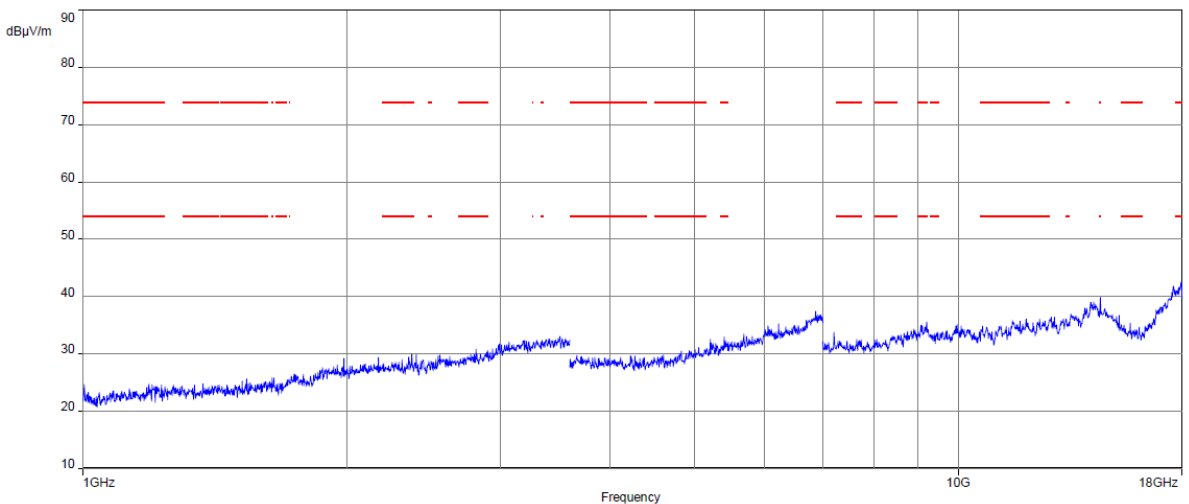

Figure 7: Part 15.247 - Spurious Emissions Radiated at from 1 GHz to 18 GHz

## 6.2 RX Measurements

The test is performed at 2402 MHz, room temperature, and normal operating conditions. The red line in Figure 8 indicates the specification limit. The DUT with the Pi filter has a good margin towards the limit.

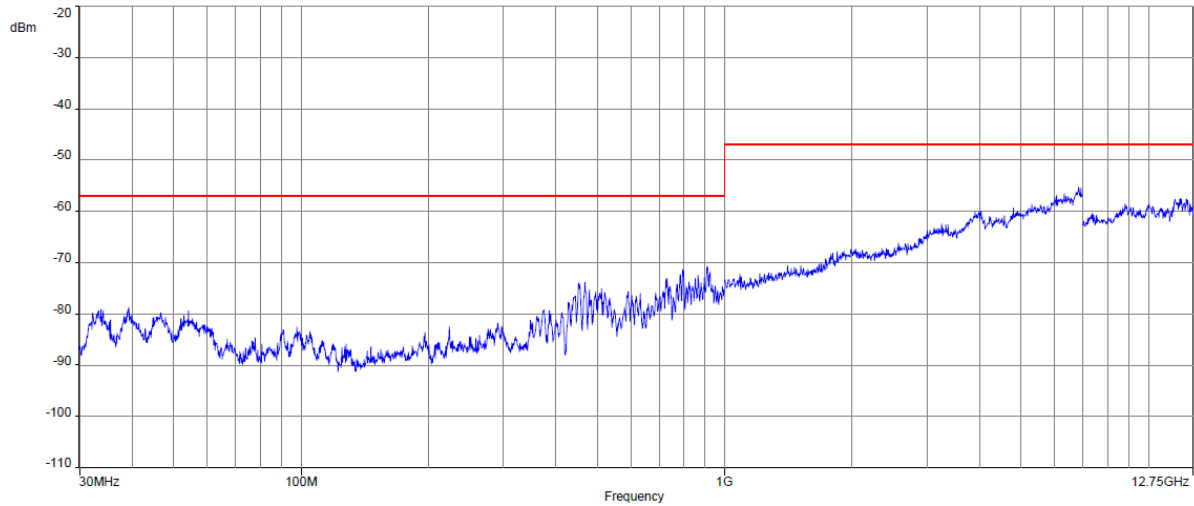

Figure 8: ETSI EN 300 328 - Receiver Spurious Emissions

## 7 Other Remarks

### 7.1 Impact on Power Consumption

The Pi filter shows no impact on the power consumption of DA14531 SoC.

### 7.2 Impact on Link Budget

The additional filter introduces <math><0.5\text{ dB}</math> loss on the fundamental power and the same loss is incurred on sensitivity. The total impact on link budget is <math><1\text{ dB}</math>.

### 8 Conclusions

The RFIO filter provides a good harmonic suppression with a minimal loss at fundamental frequencies. Dialog recommends that users include the described filter in the DA14531 design in order to pass the tests from regulatory bodies. The filter should be placed as close as possible to the RFIOp port. A schematic of an example implementation can be found in Figure 9. The shown antenna matching is chosen to match the implemented antenna to 50 Ω and will change if a different antenna is used. Experienced RF designers should be able to combine the antenna matching with the needed filtering.

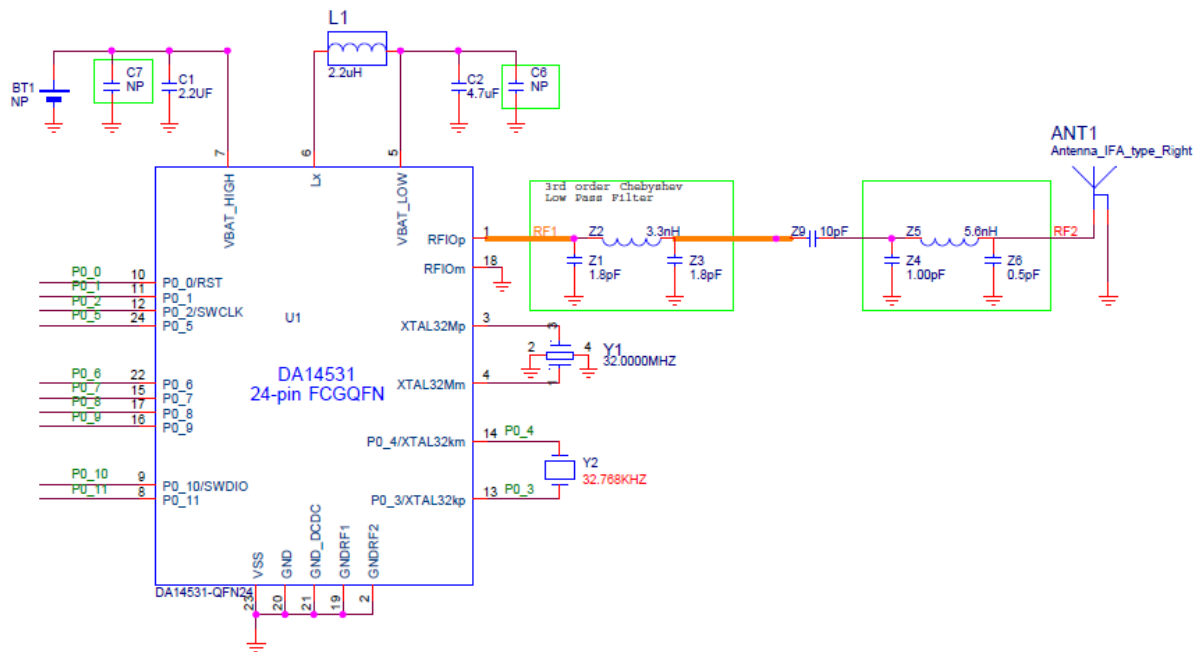

Figure 9: Schematic of Example Implementation of Pi Filter to DA14531

## Revision History

| Revision | Date        | Description                          |
|----------|-------------|--------------------------------------|
| 1.3      | 20-Jan-2022 | Updated logo, disclaimer, copyright. |
| 1.2      | 30-Oct-2019 | Link changed                         |
| 1.1      | 25-Oct-2019 | Editorial changes                    |
| 1.0      | 09-Jul-2019 | Initial version.                     |

**DA14531 Filter for Spurious Emissions Reduction**

Company Confidential

**Status Definitions**

| Status               | Definition   |
|----------------------|--|
| DRAFT                | The content of this document is under review and subject to formal approval, which may result in modifications or additions. |
| APPROVED or unmarked | The content of this document has been approved for publication.  |

## IMPORTANT NOTICE AND DISCLAIMER

RENESAS ELECTRONICS CORPORATION AND ITS SUBSIDIARIES (“RENESAS”) PROVIDES TECHNICAL SPECIFICATIONS AND RELIABILITY DATA (INCLUDING DATASHEETS), DESIGN RESOURCES (INCLUDING REFERENCE DESIGNS), APPLICATION OR OTHER DESIGN ADVICE, WEB TOOLS, SAFETY INFORMATION, AND OTHER RESOURCES “AS IS” AND WITH ALL FAULTS, AND DISCLAIMS ALL WARRANTIES, EXPRESS OR IMPLIED, INCLUDING, WITHOUT LIMITATION, ANY IMPLIED WARRANTIES OF MERCHANTABILITY, FITNESS FOR A PARTICULAR PURPOSE, OR NON-INFRINGEMENT OF THIRD-PARTY INTELLECTUAL PROPERTY RIGHTS.

These resources are intended for developers who are designing with Renesas products. You are solely responsible for (1) selecting the appropriate products for your application, (2) designing, validating, and testing your application, and (3) ensuring your application meets applicable standards, and any other safety, security, or other requirements. These resources are subject to change without notice. Renesas grants you permission to use these resources only to develop an application that uses Renesas products. Other reproduction or use of these resources is strictly prohibited. No license is granted to any other Renesas intellectual property or to any third-party intellectual property. Renesas disclaims responsibility for, and you will fully indemnify Renesas and its representatives against, any claims, damages, costs, losses, or liabilities arising from your use of these resources. Renesas' products are provided only subject to Renesas' Terms and Conditions of Sale or other applicable terms agreed to in writing. No use of any Renesas resources expands or otherwise alters any applicable warranties or warranty disclaimers for these products.

(Disclaimer Rev.1.01 Jan 2024)

### Corporate Headquarters

TOYOSU FORESIA, 3-2-24 Toyosu,  
Koto-ku, Tokyo 135-0061, Japan  
[www.renesas.com](http://www.renesas.com)

### Trademarks

Renesas and the Renesas logo are trademarks of Renesas Electronics Corporation. All trademarks and registered trademarks are the property of their respective owners.

### Contact Information

For further information on a product, technology, the most up-to-date version of a document, or your nearest sales office, please visit [www.renesas.com/contact-us/](http://www.renesas.com/contact-us/).