

Introduction of Proximity Sensing

AN1436  
Rev 0.00  
Mar 26, 2009

As ambient light sensors play an increasingly important role in our lives, proximity sensing becomes a simple and inexpensive companion that enables a wide range of the applications to make our daily life easier.

Proximity sensing based upon infrared signal detection requires two parts: infrared LED and infrared sensor. The infrared LED emits infrared signal to the sensing object, a portion of that signal bounces back from the surface of sensing object, these reflected infrared signal was then captured by the infrared sensor. The intensity of captured infrared signal changes accordingly when an sensing object is getting closer or moving, the captured infrared signal is processed in real time through light to digital conversion to reveal the distance or even the motion of sensing object.

There are many design considerations to deal with the implementation complexities of infrared signal based proximity sensing solution. These involve mechanical design that includes component selections, component placement dimensions, glass cover characteristics, optical design and overall system design to achieve an optimal proximity sensing solution.

This application notes mainly cover mechanical design that is a critical component of the overall proximity sensing system solution, it involves LED selections, isolation techniques between sensor and LED, component placement dimensions and glass cover characteristics etc. The proximity sensing readout comparison based upon different design variations and trade-offs is used to decide optimal choice for different application and system requirement.

**Proximity Sensing and Ambient Light Sensing Function**

Most light source emissions are composed of both visible and infrared spectrum content. Different light sources can have similar visible light intensity in terms of lux but very different infrared spectrum response. The difference in the spectrum characterization and the spectral sensitivity of the photo detector has to be taken into account when measuring light intensity. A standard photo detector implemented on a typical CMOS process that detects mostly infrared radiation (peak sensitivity at 880nm) can cause false readings about the real ambient visible conditions.

For infrared-rich light sources like light bulbs, the photo detector signals are much higher than the amount seen by the human eye. Lighting solutions controlled by such sensors will not resemble the optimum brightness as felt by human eyes. To establish a more suitable dimming or lighting control as part of a system solution, it is essential to find a sensor which emulates human eyes as closely as possible.

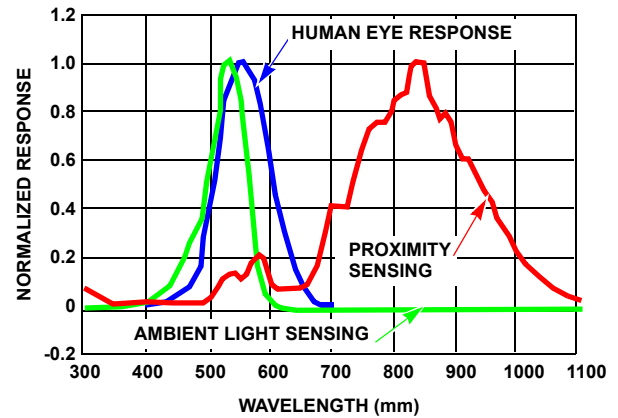

FIGURE 1. SPECTRAL RESPONSE OF AMBIENT LIGHT SENSOR AND PROXIMITY SENSOR

Intersil's integrated digital ambient light and proximity sensor is equipped with a programmable infrared LED driver, 16-bit analog to digital converter, interrupt functional control unit and I<sup>2</sup>C/SMBus digital interface. The device provides not only ambient light sensing to allow conventional backlight and display brightness adjustment but also proximity sensing for distance and motion detection.

For ambient light sensing, it functions like other ambient light sensor product. Figure 2 shows the architecture of charge integration ADC continuously counts up to 16-bit. The photo current stimulates charge which accumulates onto the integration capacitor depending on the number of clock cycles (up to 2<sup>16</sup>), then the op-amp and comparator helps to convert the analog photo current signal into digital output.

For infrared proximity sensing, the internal IR LED driver turns on and delivers from 12.5mA to 100mA to drive the external IR LED. Figure 3 shows the entire proximity detection cycle requires three different sequential phases: ambient light sensing, infrared sensing and proximity sensing.

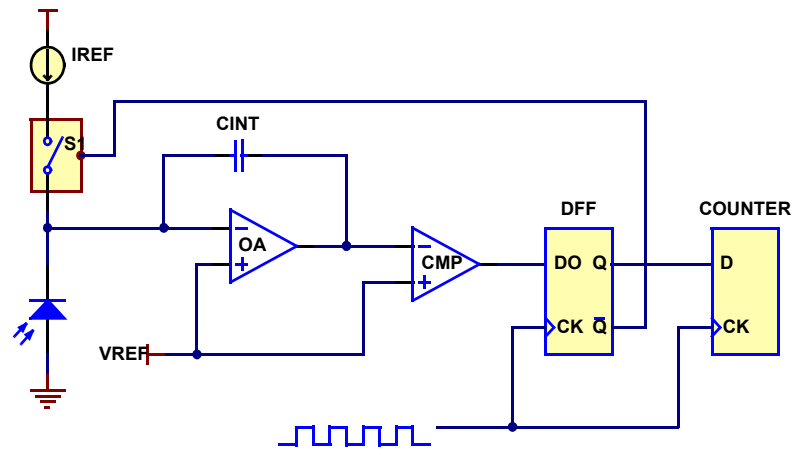

FIGURE 2. 16-BIT CHARGE INTEGRATION ADC

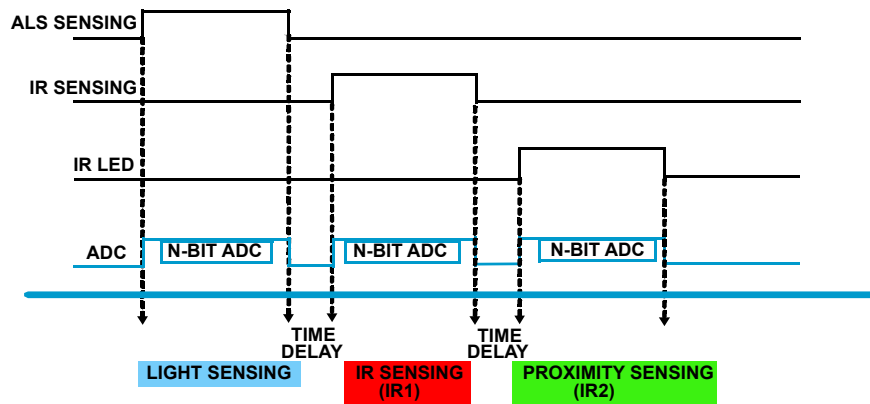

FIGURE 3. INTEGRATION TIMING SEQUENCE FOR PROXIMITY DETECTION

When the integrated digital ambient light and proximity sensor is programmed in proximity sensing mode, the external IR LED is turned on by the built-in IR LED driver to sink 12.5mA, 25mA, 50mA or 100mA current based on user programmed choice. When the infrared sensing signal from the LED reaches the sensing object and gets reflected back, the reflected infrared signal is captured by the infrared sensor and converted into photo current, then further converts into 16-bit digital data stream. The eventual proximity readout is linearly proportional to the reflected infrared signal intensity but inversely proportional to the square of the distance between proximity sensor and the sensing object. When under significant background infrared noise like direct sunlight, both infrared sensing phase and proximity sensing phase are needed for background noise cancellation.

Figure 4A illustrates when there is no sensing object in proximity detection path, no reflected infrared signal is bounced back to the proximity sensor, the proximity readout returns to default baseline counts. When the sensing object is within 10cm distance from the center point between the IR LED and the light sensor as shown in Figure 4B, the reflected infrared signal is captured by the sensor, the proximity readout

is linearly proportional to the captured infrared light signal intensity and inverse proportional to the square of the distance.

## Mechanical Design Considerations

### IR LED Selections

It is important to choose an effective infrared LED that has typical peak wavelength matches the proximity sensor spectrum, a narrow viewing angle with higher radiant intensity will also help to concentrate the energy that is ideal for proximity sensing.

Different types of infrared LEDs make differences for proximity sensing detection distance. The photodiode array is very sensitive to various IR LED characteristics that include viewing angle, light intensity and typical peak spectrum wavelength. The detection infrared photodiode array is designed and self-calibrated to the peak wavelength of 850nm or 940/950nm, to match the infrared peak wavelength is obvious top priority. A narrow viewing angle also helps to concentrate the energy and infrared signal intensity. It is important to choose an infrared LED to balance the trade-offs among view-angle, mechanic height, footprint, radiant intensity and current consumption.

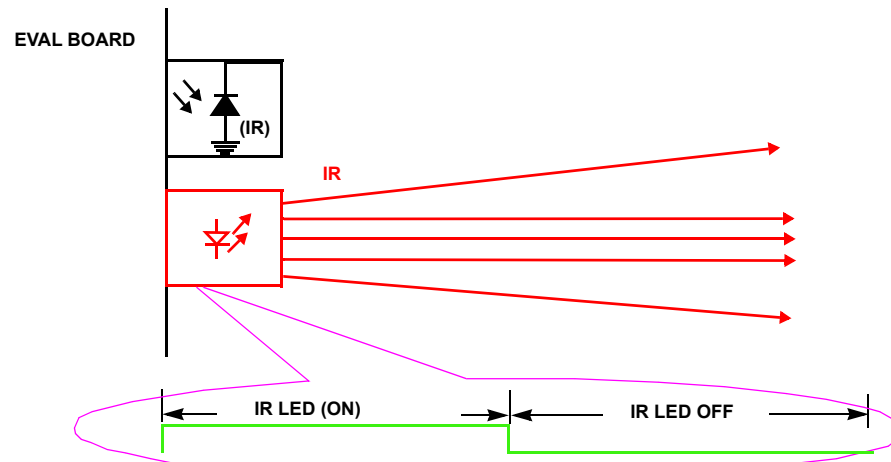

FIGURE 4A. NO SENSING OBJECT IN PROXIMITY DETECTION AREA

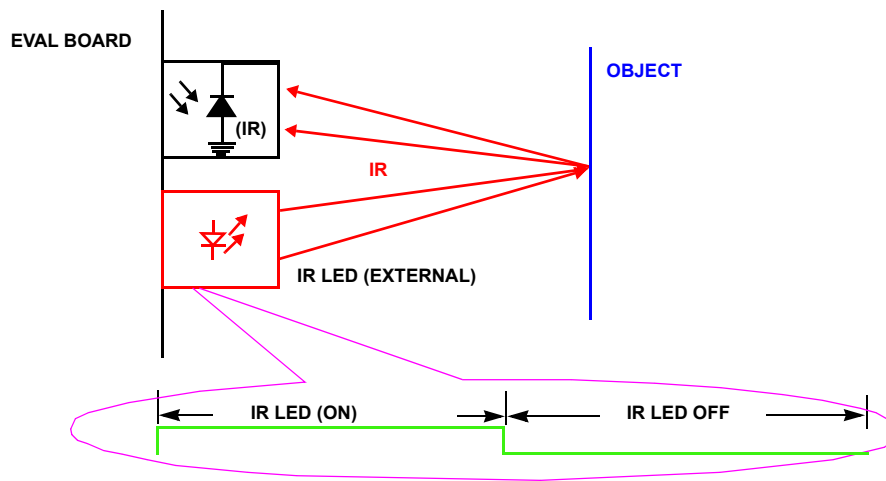

FIGURE 4B. SENSING OBJECT WITHIN 10CM FOR PROXIMITY DETECTION

### Component Placement Dimensions

Component placement plays a crucial role in the mechanical design as part of a proximity detection system. There are many deciding factors: space between sensor to barrier, distance from barrier to IR LED, barrier height variations, with or without light pipe, and light pipe difference in terms of dimensions, reflectivity and manufacturing materials etc. The following section provides implementation details based on the mechanical design that was used to build the typical evaluation board. It provides performance comparison in terms of proximity sensitivity for different placement considerations.

Figure 5 shows the conventional proximity sensing system solution with typical mechanical design dimensions. The center to center distance between sensor and LED is defined as A, the distance between sensor to barrier is defined as B, the

distance between LED and barrier is defined as C, the height of barrier is defined as D.

The following sections illustrate these mechanical dimension variations by comparing proximity readout through ADC count. Figure 7, Figure 9 and Figure 11 only show peak sensitivity corresponds to the variation of dimension A, B and C at very near detection distance (<10mm) although actual proximity sensing solution capable to detect much longer distance as shown in the data sheet.

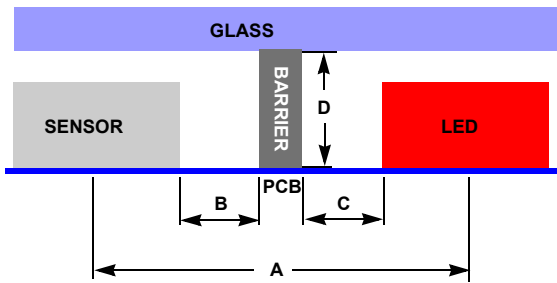

A = 4mm to 5mm C = 0mm to 0.5mm  
 B = 0mm to 0.5mm D = 2mm to 2.2mm

NOTE: RELATIVE TO 1.8mm TALL OSRAM IR LED  
 (ADJUSTMENTS MAY NEED TO BE MADE WITH  
 IR LED)

FIGURE 5. TYPICAL MECHANICAL DESIGN DIMENSIONS

PLACEMENT OF SENSOR RELATIVE TO IR LED

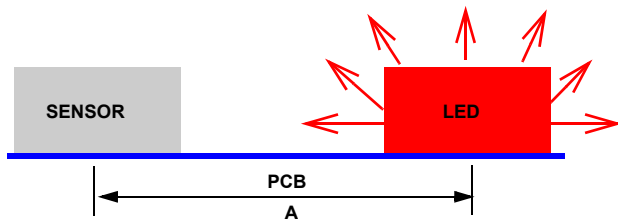
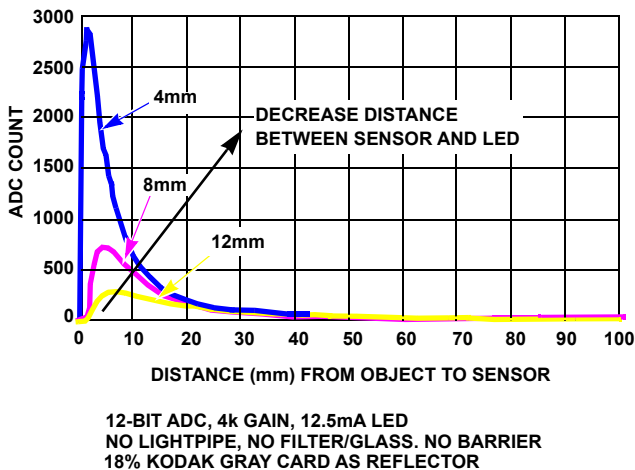

FIGURE 6. DIAGRAM OF LOCATION OF SENSOR AND LED

The IR LED and sensor need to be close to ensure better distance detection (as further distance lowers sensitivity). However, the closer the IR LED and the sensor, the greater the risk of crosstalk between the two components. A barrier is required to prevent the crosstalk between sensor and LED especially under glass. Figure 7 compares different distance Placement of Barrier Relative to Sensor

variations between dimension A and proximity detection sensitivity.



12-BIT ADC, 4k GAIN, 12.5mA LED  
 NO LIGHTPIPE, NO FILTER/GLASS. NO BARRIER  
 18% KODAK GRAY CARD AS REFLECTOR

FIGURE 7. PROXIMITY SENSOR OUTPUT VARYING THE  
 DISTANCE BETWEEN THE SENSOR AND LED

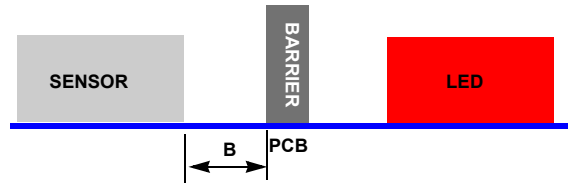
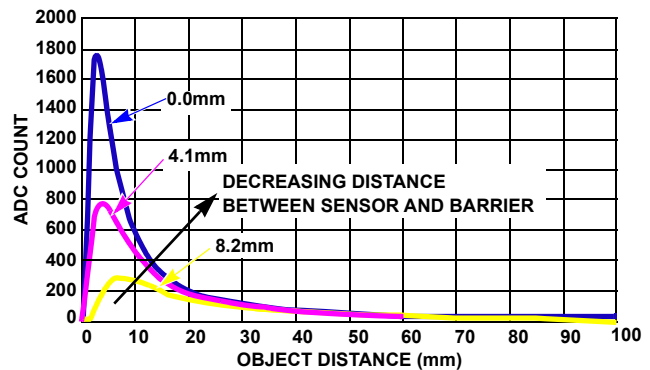

FIGURE 8. DIAGRAM HIGHLIGHTING THE SPACING  
 BETWEEN THE SENSOR AND BARRIER

The distance of the barrier relative to the sensor plays a trade-off. The closer the barrier to the sensor, the greater the risk of a shadowing effect. The risk of a shadowing effect can be minimized by the use of a barrier that is just barely taller than the higher component (between sensor or IR LED). Figure 9 compares the proximity readout in terms of distance variations between sensor and barrier.



12-BIT ADC, 4k GAIN, 12.5mA LED  
 LED ENCIRCLED BY BARRIER 2.1mm  
 NO LIGHTPIPE, NO FILTER/GLASS  
 4mm CENTER-TO-CENTER LED TO SENSOR  
 18% KODAK GRAY CARD AS REFLECTOR

FIGURE 9. OUTPUT OF THE PROXIMITY SENSOR VARYING  
 THE DISTANCE BETWEEN THE SENSOR AND  
 BARRIER

PLACEMENT OF BARRIER RELATIVE TO IR LED

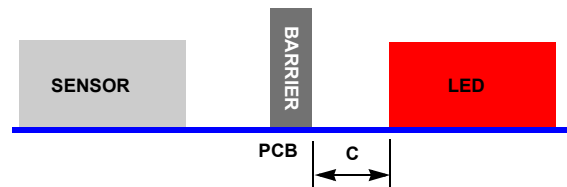

FIGURE 10. DIAGRAM HIGHLIGHTING DISTANCE BETWEEN  
 THE LED AND BARRIER

The distance between IR LED and barrier is constrained by two factors. The IR LED needs to be as close as possible to the sensor for optimal proximity sensing. However, the IR LED viewing angle can be affected if too close to the barrier. The use of a barrier that is slightly taller than the higher component (between IR LED or Sensor) in the system is suggested. The most effective distance between the Barrier and IR LED is 0mm to 0.5mm, when a 2.1mm tall barrier is used with a 1.8mm tall IR LED Sensor.

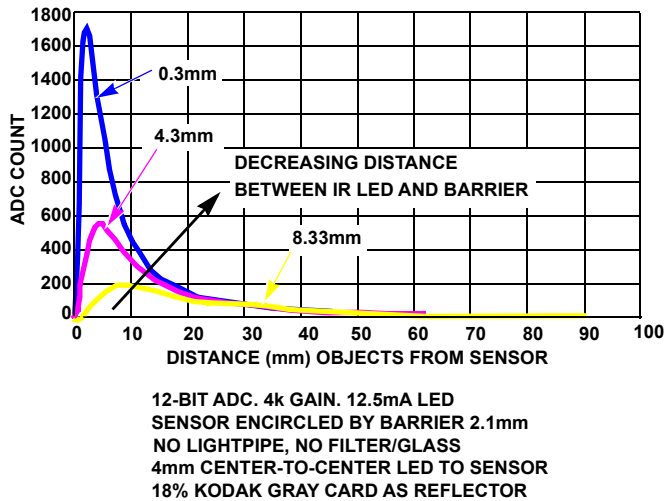

FIGURE 11. OUTPUT OF PROXIMITY SENSOR FOR VARYING DISTANCE BETWEEN LED AND BARRIER

**BARRIER HEIGHT**

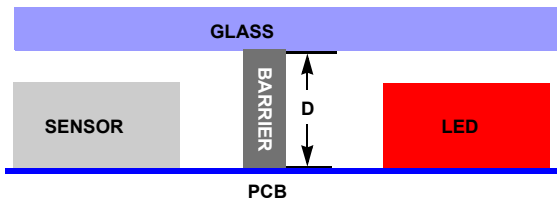

FIGURE 12. DIAGRAM OF PROXIMITY SET-UP HIGHLIGHTING THE HEIGHT OF THE BARRIER

A barrier is needed between the sensor and IR LED to prevent crosstalk as shown in Figure 13. The barrier can only work effectively if the distance of the glass cover from the PCB is the exact height of barrier (glass cover is flush with the barrier). The taller the barrier, the greater risk of a shadowing effect for a narrowed viewing angle of IR LED. The optimal height of barrier is 2.1mm when using a 1.8mm tall IR LED, as seen in Figure 13.

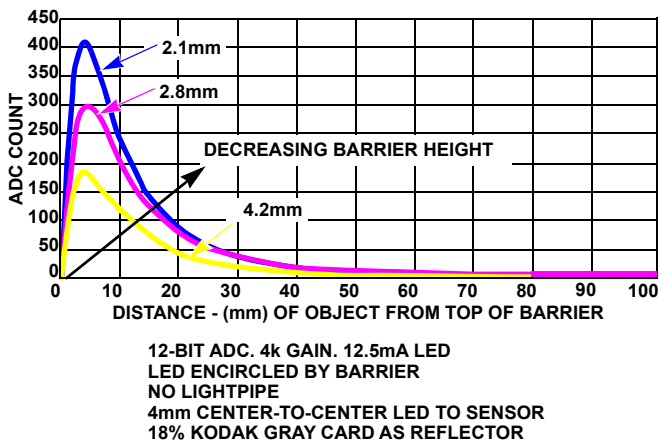

FIGURE 13. OUTPUT OF PROXIMITY SENSOR WITH DIFFERENT BARRIER HEIGHTS

**CENTER TO OBJECT DISTANCE**

The sensing distance is affected by the percentage transmittivity of glass cover used to enclose the system. If the glass cover has high percentage transmittivity for IR spectrum, then the detection distance can be easily extended beyond 50mm depending on sensing object. For the same detection distance, the more IR spectrum filter out by the glass cover, the larger LED driving current is required to compensate.

**Glass Window Dimensions and Placement**

For a flat surface lens, the viewing angle is a function of the refractive index of the plastic or glass material. A more dense material (higher refractive index) will have a less effective viewing angle. Snell's law states that when a light ray which strikes at an angle and continues through a more dense material (plastic), the light bends towards the normal of the surface of the more dense material (Figure14 (A)).

Consequently, a less dense medium will have a wider viewing angle than denser material. As an example, a plastic with refractive index of 1.57 will have a very limited viewing angle of less than 80° (Figure14 (C)). On the other hand, a glass with an index of refraction of 1.3 will have a 101° viewing angle.

A window lens will surely limit the viewing angle of the sensor. The window lens should be placed directly on top of the device. The thickness of the lens should be kept at minimum to reduce loss of power due to reflection and also to minimize loss due to absorption in the plastic material. A thickness of  $t = 1\text{mm}$  is recommended. The bigger the width (or diameter) of the window lens, the wider the viewing angle is of the sensor. Table1 shows the recommended dimensions of the optical window to ensure both 35° and 45° viewing angles. These dimensions are based on a window lens thickness of 1.0mm and a refractive index of 1.59.

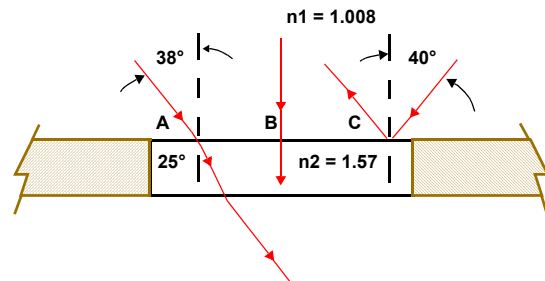

FIGURE 14. FLAT SURFACE LENS. (A) LIGHT RAY REFRACTS AFTER PASSING THROUGH A MEDIUM. (B) ANGLE OF INCIDENCE IS NORMAL TO SURFACE. (C) LIGHT INCIDENT IS GREATER THAN CRITICAL ANGLE.

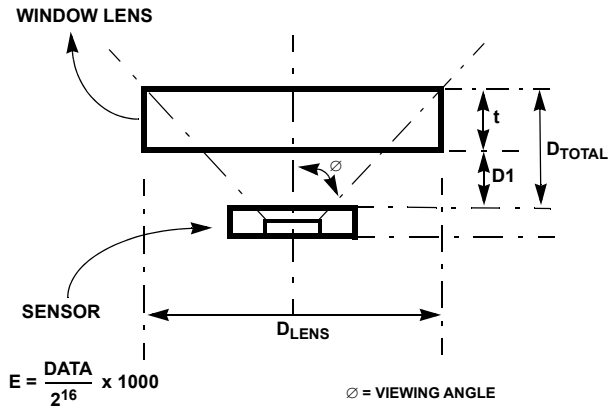

FIGURE 15. FLAT WINDOW LENS

TABLE 1. RECOMMENDED DIMENSIONS FOR A FLAT WINDOW DESIGN

D <sub>TOTAL</sub>	D <sub>1</sub>	D <sub>LENS</sub> @ 35° VIEWING ANGLE	D <sub>LENS</sub> @ 45° VIEWING ANGLE
1.5	0.50	2.25	3.75
2.0	1.00	3.00	4.75
2.5	1.50	3.75	5.75
3.0	2.00	4.30	6.75
3.5	2.50	5.00	7.75

t = 1 Thickness of lens  
 D<sub>1</sub>: Distance between sensor and inner edge of lens  
 D<sub>LENS</sub>: Diameter of lens  
 D<sub>TOTAL</sub>: Distance constraint between the sensor and lens outer edge  
 NOTE: All dimensions are in mm

**USING BARRIER**

In practical usage of Intersil Proximity Sensor, the sensor typically is placed beneath some sort of glass/plastic cover. The glass cover impacts the performance of the device by raising the noise floor. This is caused by part of the emitted IR Light from IR LED being reflected from the glass cover and reaching the sensor.

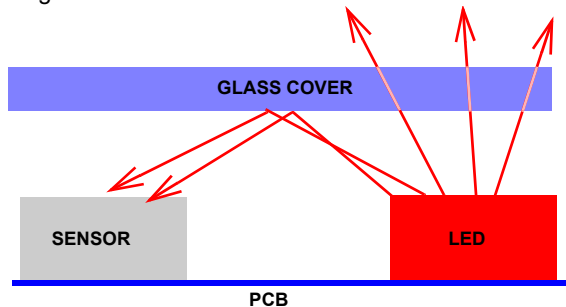

FIGURE 16. DIAGRAM OF PROXIMITY SET-UP HIGHLIGHTING CROSSTALK REFLECTED FROM COVER GLASS

To prevent this, a barrier/blockade is strongly advised to be placed between the IR LED and the Sensor. The placement of

the barrier to the sensor and LED is discussed in detail in earlier sections.

We recommend a barrier that is 0.8mm thick black plastic tube that encircles the IR LED. A barrier that fully encircles the IR LED allows for superior noise immunity.

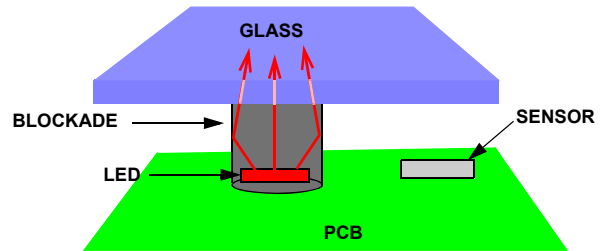

FIGURE 17. DIAGRAM OF PROXIMITY SET-UP HIGHLIGHTING A CIRCULAR BARRIER SURROUNDING THE LED

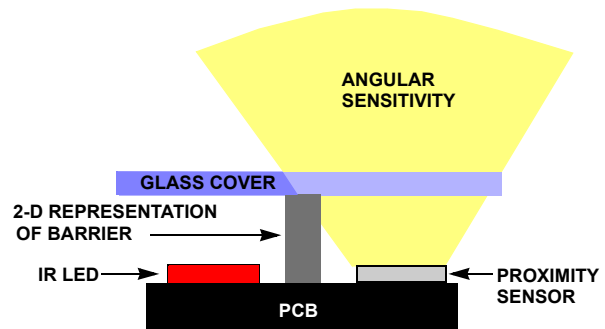
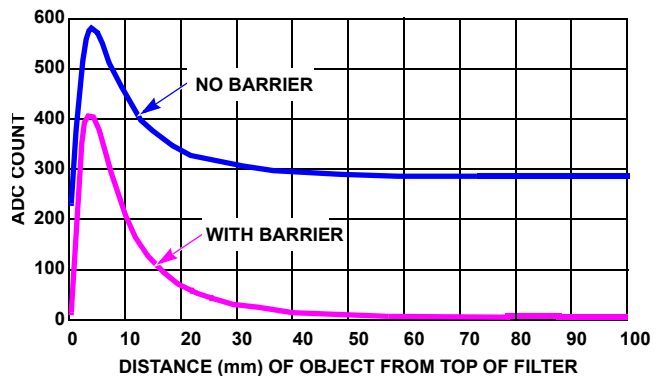

FIGURE 18. DIAGRAM OF PROXIMITY SET-UP HIGHLIGHTING THE ANGULAR SENSITIVITY OF THE SENSOR

In addition to encircling the IR LED, the height should be exact distance of glass cover to PCB. Still, the distance between glass cover and PCB should be minimized if possible. Figure 19 shows the improved performance of the device and lowering of the noise floor when a barrier is applied.



12-BIT ADC, 4k GAIN, 12.5mA LED  
 NO LIGHT PIPE  
 4mm CENTER-TO-CENTER LED TO SENSOR  
 5% AMBIENT 80% IR TRANSMISSION GLASS

FIGURE 19. PROXIMITY SENSOR OUTPUT TAKEN WITH AND WITHOUT A BARRIER

**Proximity Sensor Algorithms**

Once the electrical and mechanical design considerations of a proximity sensor are determined, it's important to test sensor in different product scenario. If the design requires the proximity sensor to identify an approaching object, then testing will reveal the output readings with respect to distance. The shape of the output depends on the composition of the object. The proximity response then allows the designer to select an appropriate detection scheme.

The output of the analog-to-digital converter (ADC count) has a typical response as shown in Figure 20.

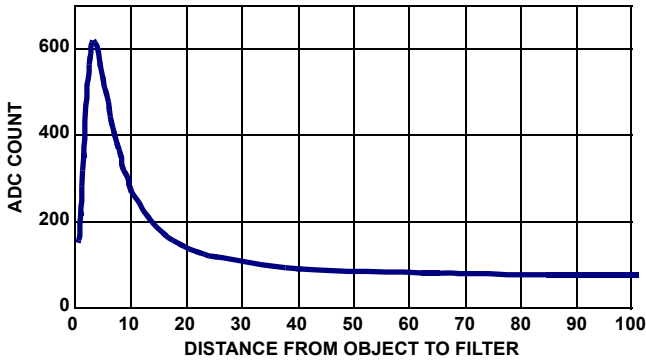

**FIGURE 20. PROXIMITY RESPONSE CURVE vs DISTANCE FOR A TYPICAL OBJECT**

Figure 20 shows a peak ADC count at a distance just a few millimeters from the detector. The response drops at shorter distances because there is space between the emitter and detector. The closeness of the object reduces the amount of light that can reflect to the detector.

As the object moves far from the system, the ADC count flattens. This level is the noise floor set by the surrounding environment. The combination of the peak and noise floor is crucial in setting a trigger level.

**CASE 1 ALGORITHM**

When the detected object is human skin, the design is somewhat simplified. Infrared light can penetrate human skin.

The peak is shifted to a closer distance and the ADC count does not plummet at zero distance (Figure 21)..

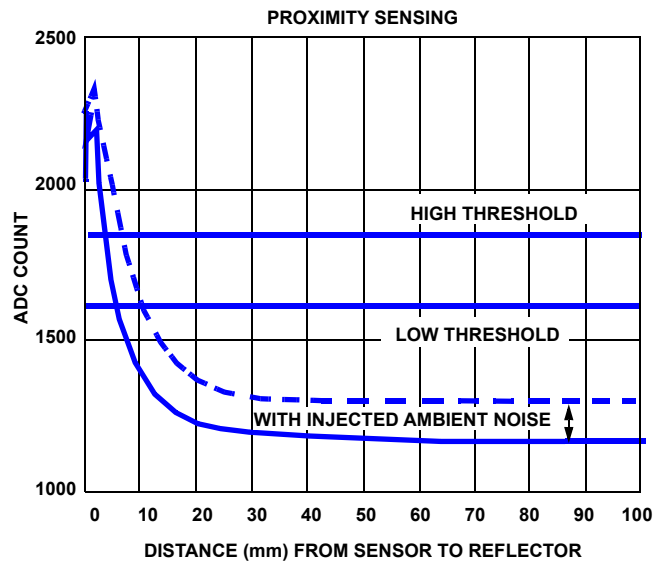

**FIGURE 21. PROXIMITY RESPONSE CURVE vs DISTANCE FOR HUMAN SKIN**

The shape of this response allows for a simple threshold scheme to identify the proximity of a human (as in the case of answering a cell phone call). The low threshold must be high enough to ignore any changes in ambient noise. The high threshold must be low enough to withstand any changes in the peak output ADC count. The space between them must also be large enough to handle any ambient changes.

Figure 22 reveals the design process for this type of system.

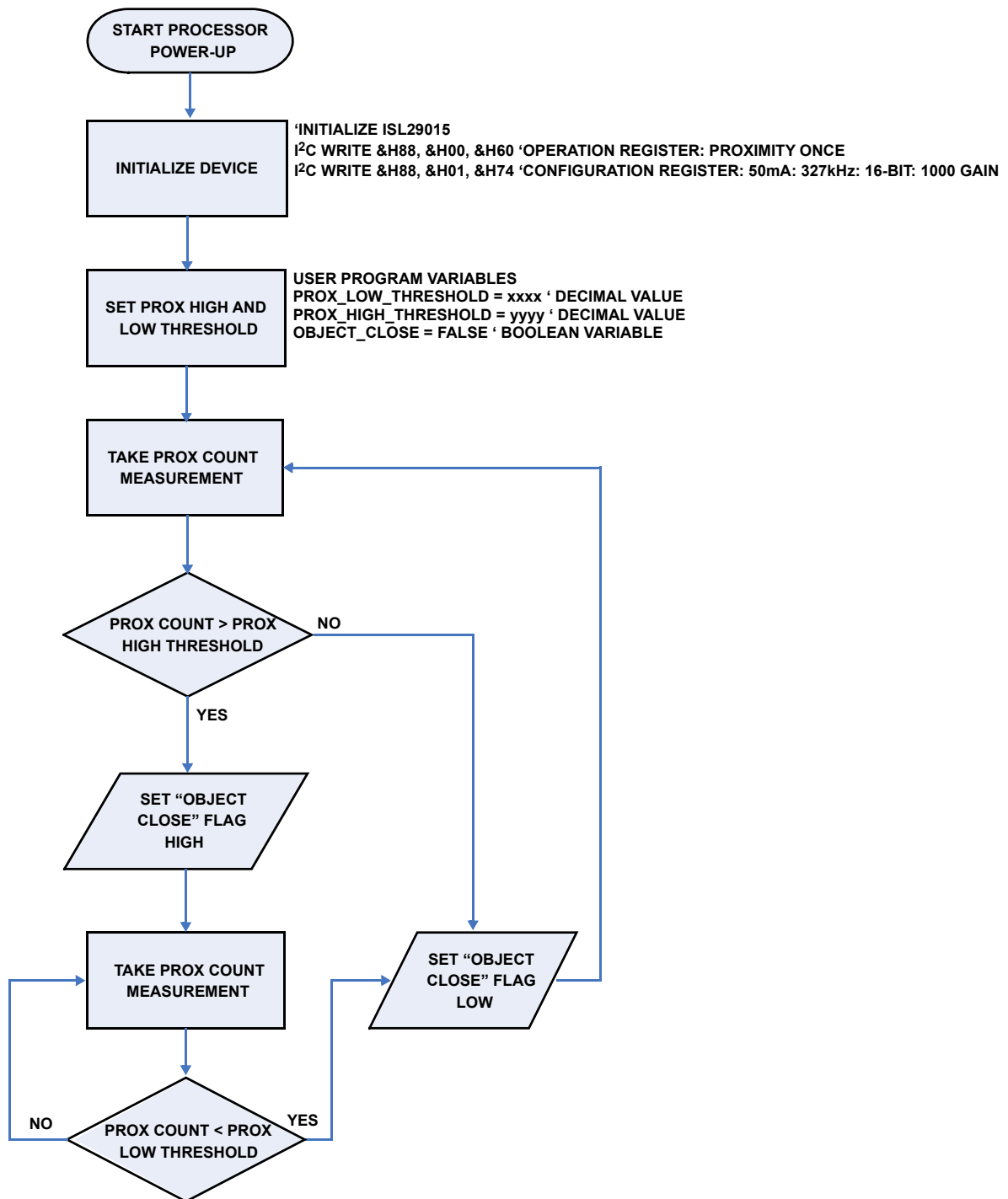

DETAIL A: TAKE PROXIMITY COUNT MEASUREMENT DETAIL  
 'ISL29015 PROX-IR MEASUREMENT SEQUENCE  
 I<sup>2</sup>C WRITE &H88, &H00, &H60 'OPERATION REGISTER: PROXIMITY ONCE  
 DELAY 120ms  
 I<sup>2</sup>C READ &H89, &H02, LSB\_BYTE, MSB\_BYTE 'READ AD REG: 2 BYTES  
 PROX\_RAW = (MSB\*256)+LSB  
 I<sup>2</sup>C WRITE &H88, &H00, &H40 'OPERATION REGISTER: IR ONCE  
 DELAY 120ms  
 I<sup>2</sup>C READ &H89, &H02, LSB\_BYTE, MSB\_BYTE 'READ AD REG: 2 BYTES  
 IR\_RAW = (MSB\*256)+LSB  
 PROX\_COUNT = PROX\_RAW-IR\_RAW 'SAVE CALCULATED PROXIMITY IN VARIABLE

FIGURE 22. FLOW-CHART FOR PROXIMITY SYSTEM DETECTING HUMAN SKIN



**CASE 2 ALGORITHM**

The case 2 algorithm is for a system with a response similar to the curve in Figure 20. Again, we would like to set a low and high threshold. However, the selection is more complicated since the low threshold selection will, most likely, cross the proximity response curve twice (Figure 23).

The lower threshold is used to identify the evacuation of an object from the area directly above the proximity sensor. Only one of the 2 crosspoints will correctly identify that situation, the second one on the right side of the peak.

To determine which of the objects distance has caused the threshold to be crossed, we sense the amount of ambient light (Figure 24). Ambient light can be used because the object will naturally obstruct ambient light as it approaches the sensor. Since the object blocks virtually no ambient light at large distances and blocks a continuously increasing amount of light as it approaches the sensor, the amount of ambient light gives us another measurement we can use to separate the two lower threshold crossings from each other.

The ambient light (by the Ambient Light Sensor) is sampled any time the high threshold is crossed. That value is stored in a register. When the low threshold is crossed, the ambient light is sampled again. If the ambient light reading is less than the value taken at the same low threshold, then we are on the left side of the curve—the low threshold crossing we want to ignore. However, if the ambient light reading is greater than the value taken at the high threshold, the object is further away from both sensors and we are on the right side of the curve. A microcontroller can be programmed to identify the real low threshold crossings. A flowchart describing the design methodology of case 2 is given in Figure 25.

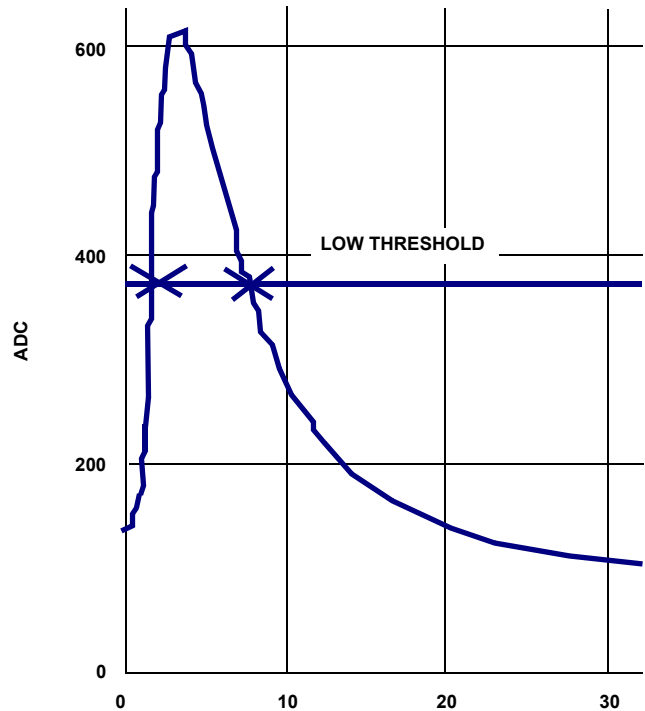

**FIGURE 23. PROXIMITY RESPONSE CURVE vs DISTANCE WITH LOW THRESHOLD CROSSING**

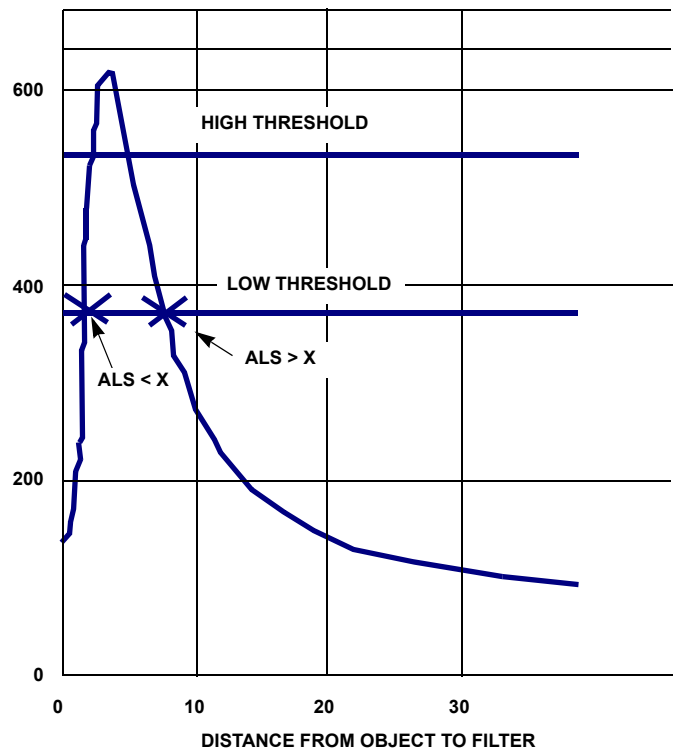

**FIGURE 24. PROXIMITY RESPONSE CURVES vs DISTANCE WITH HIGH THRESHOLDS**

CASE 2: ALGORITHM FOR PROX COUNT DECREASES AS THE OBJECT IS CLOSE TO THE GLASS.

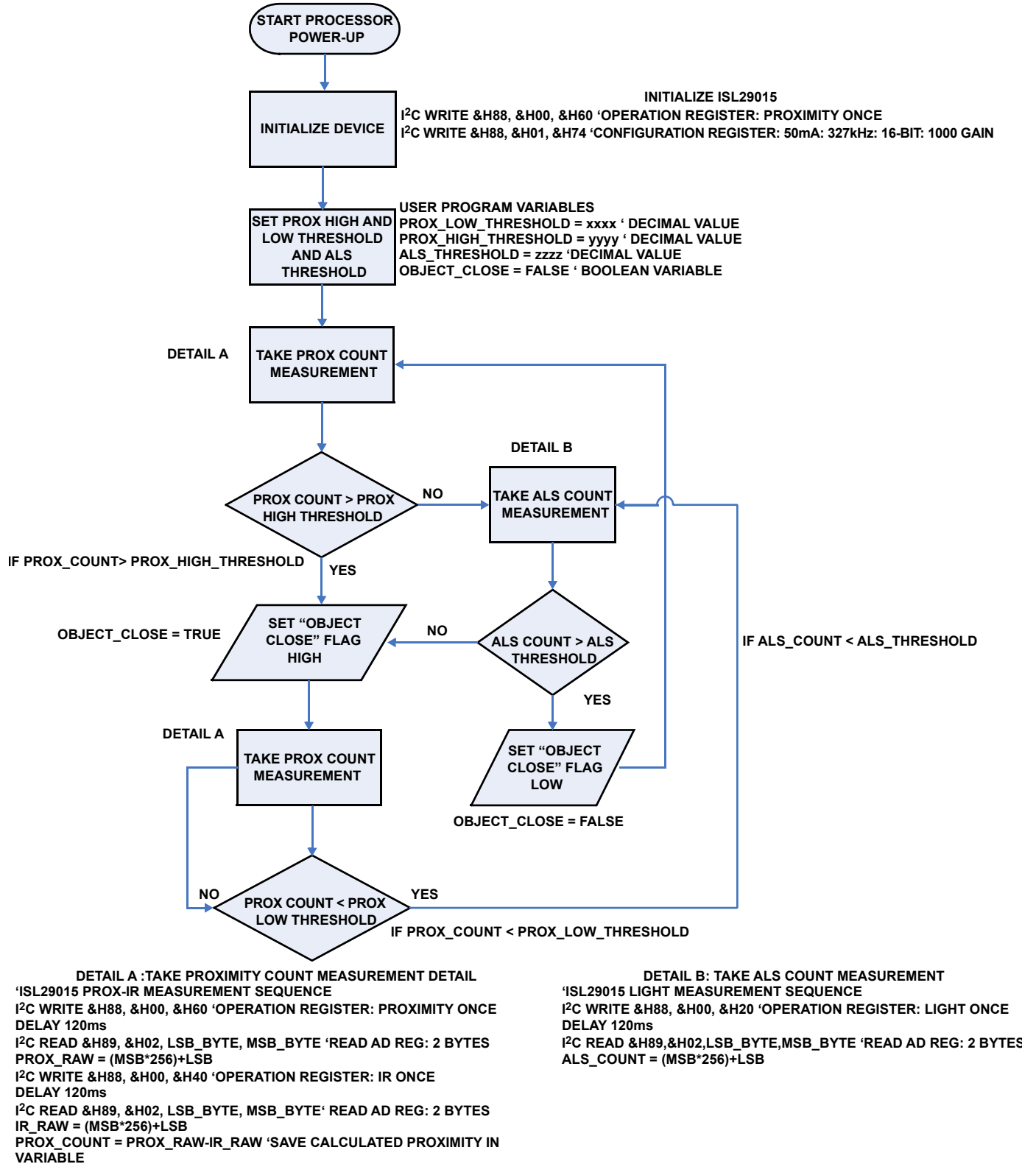

FIGURE 25. FLOW-CHART FOR PROXIMITY SYSTEM DETECTING GENERIC OBJECT

## IMPORTANT NOTICE AND DISCLAIMER

RENESAS ELECTRONICS CORPORATION AND ITS SUBSIDIARIES (“RENESAS”) PROVIDES TECHNICAL SPECIFICATIONS AND RELIABILITY DATA (INCLUDING DATASHEETS), DESIGN RESOURCES (INCLUDING REFERENCE DESIGNS), APPLICATION OR OTHER DESIGN ADVICE, WEB TOOLS, SAFETY INFORMATION, AND OTHER RESOURCES “AS IS” AND WITH ALL FAULTS, AND DISCLAIMS ALL WARRANTIES, EXPRESS OR IMPLIED, INCLUDING, WITHOUT LIMITATION, ANY IMPLIED WARRANTIES OF MERCHANTABILITY, FITNESS FOR A PARTICULAR PURPOSE, OR NON-INFRINGEMENT OF THIRD PARTY INTELLECTUAL PROPERTY RIGHTS.

These resources are intended for developers skilled in the art designing with Renesas products. You are solely responsible for (1) selecting the appropriate products for your application, (2) designing, validating, and testing your application, and (3) ensuring your application meets applicable standards, and any other safety, security, or other requirements. These resources are subject to change without notice. Renesas grants you permission to use these resources only for development of an application that uses Renesas products. Other reproduction or use of these resources is strictly prohibited. No license is granted to any other Renesas intellectual property or to any third party intellectual property. Renesas disclaims responsibility for, and you will fully indemnify Renesas and its representatives against, any claims, damages, costs, losses, or liabilities arising out of your use of these resources. Renesas' products are provided only subject to Renesas' Terms and Conditions of Sale or other applicable terms agreed to in writing. No use of any Renesas resources expands or otherwise alters any applicable warranties or warranty disclaimers for these products.

(Rev.1.0 Mar 2020)

### Corporate Headquarters

TOYOSU FORESIA, 3-2-24 Toyosu,  
Koto-ku, Tokyo 135-0061, Japan  
[www.renesas.com](http://www.renesas.com)

### Contact Information

For further information on a product, technology, the most up-to-date version of a document, or your nearest sales office, please visit:  
[www.renesas.com/contact/](http://www.renesas.com/contact/)

### Trademarks

Renesas and the Renesas logo are trademarks of Renesas Electronics Corporation. All trademarks and registered trademarks are the property of their respective owners.