

## Introduction

This document provides information on various methods for programming an EEPROM so that the desired settings will be loaded into the 8T49N24x (8T49N240i, 8T49N241i, or 8T49N242i) device registers at boot-up.

## Overview

The 8T49N24x devices have an option to load their settings from OTP, EEPROM, or both (with EEPROM overriding OTP). The EEPROM can easily make changes to the settings that will persist between device power-ups. This guide shows how to program the EEPROM using the 8T49N240i, 8T49N241i, or 8T49N242i Evaluation Board; however, the principles apply to designs in general.

Items needed:

- IDT8T49N240i, IDT8T49N241i, or IDT8T49N242i Evaluation Board with AT24C04 EEPROM installed
- 1 regular USB cable
- Timing Commander™ v1.5.3.1 or later installed on a PC
- 8T49N24x Timing Commander™ Personality v0.8 or later

If using a Dash-Code or existing configuration file:

1. Copy the configuration file to the Desktop. Do not load the original directly from Timing Commander.
2. Open the file through the initial pop-up window, or by clicking on the part number in the top-left corner of the screen if a previous settings file was being used (see the following figures).

If writing a new configuration:

1. Create a new settings file through the initial pop-up window, or by clicking on the part number in the top-left corner of the screen if a previous settings file was being used (see the following figures).
2. Provide all necessary input/output settings that are required.

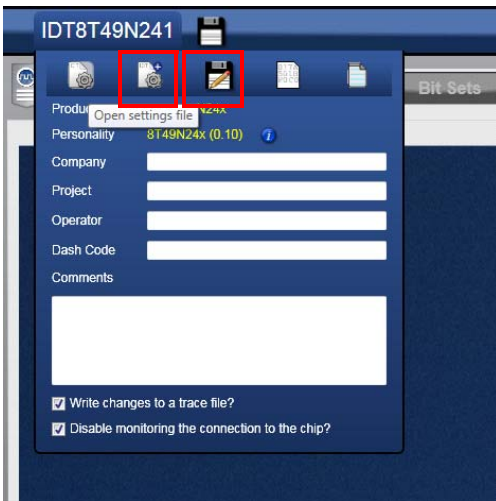

After the settings file is ready, the following methods are available to write the settings to the EEPROM:

- [Method 1: Direct Write to EEPROM Using Timing Commander and the Evaluation Board](#)
- [Method 2: Copy Register Values and CRC to Clipboard](#)
- [Method 3: Save Register Values to a File](#)

## EEPROM Programming Methods

### Method 1: Direct Write to EEPROM Using Timing Commander and the Evaluation Board

This method uses Timing Commander to directly write to the attached EEPROM via the 8T49N241i or 8T49N242i Evaluation Board. Before beginning, make sure Timing Commander is installed, the 8T49N24x personality file is downloaded, the 8T59N24i evaluation board is powered, and the USB cable is plugged into the evaluation board and the computer. The following steps will perform the EEPROM write:

1. Inside Timing Commander, press the “Connect to the Chip” button at the top-right corner of the window.

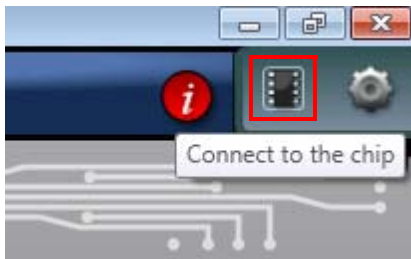

2. If everything is connected correctly, the top box should expand and turn green.

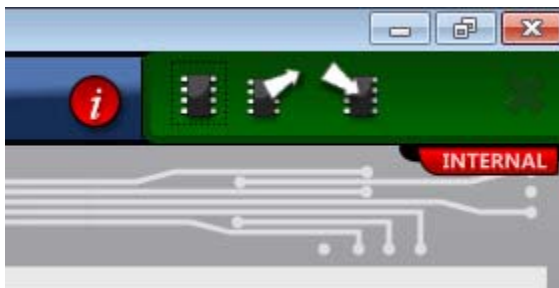

3. Use the “WriteAll” button to reveal the Write All dialogue window.



4. Press “Write to Connected Chip”

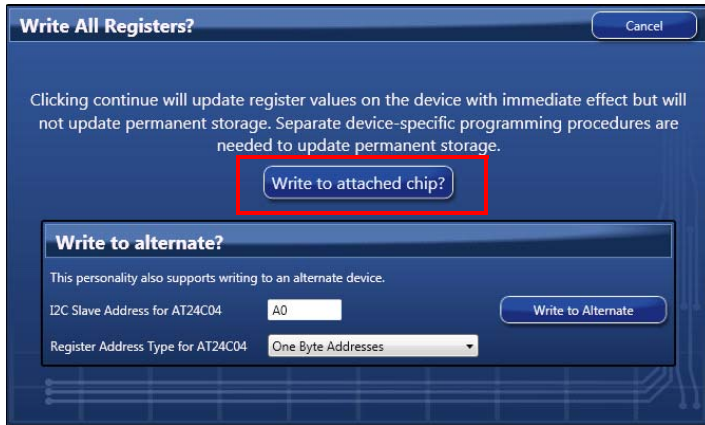

5. A successful registers write will return a successful message pop-up.



6. Verify the device is configured correctly by using single-register reads and checking the outputs.

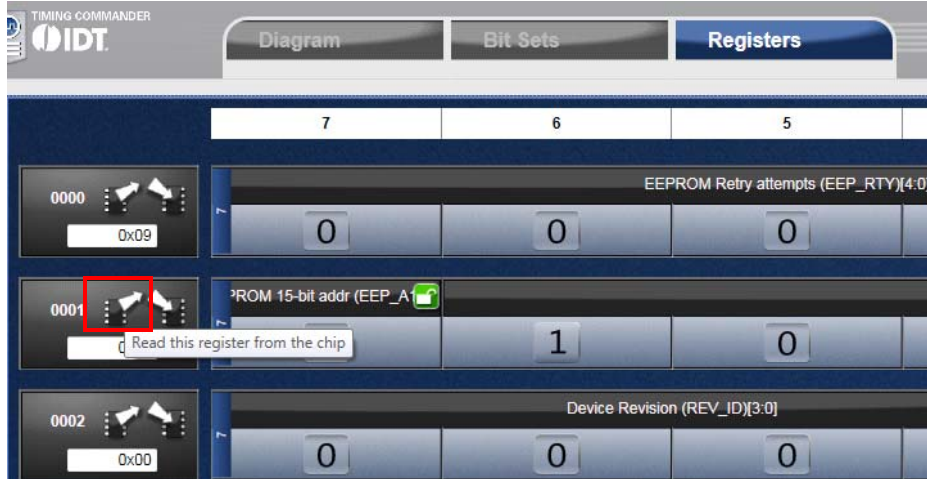

7. Use the “WriteAll” button to reveal the Write All dialogue window again.

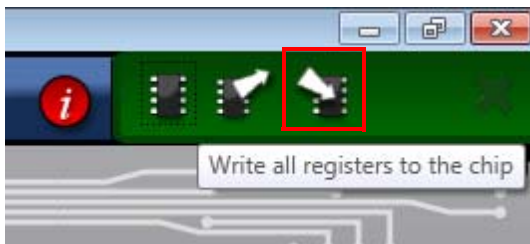

8. This time press "Write to Alternate".

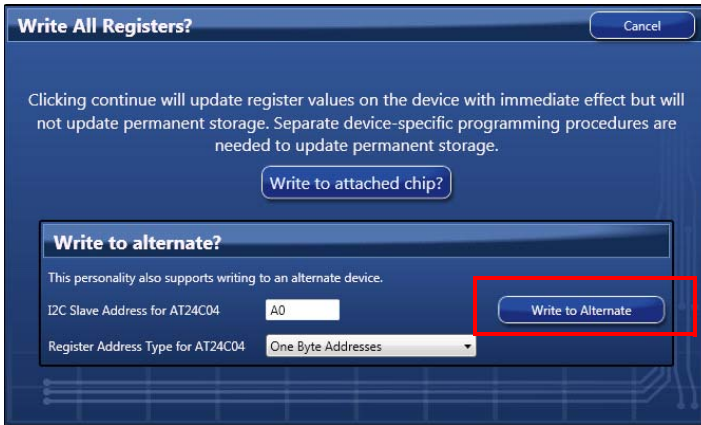

9. A successful EEPROM write will return a successful message pop-up.

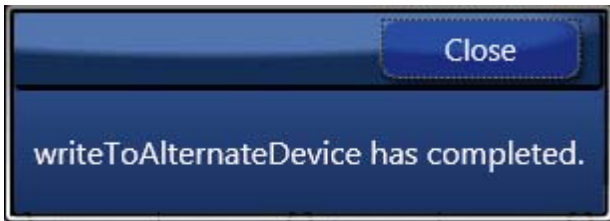

10. Press the reset button on the evaluation board (see the User's Guide for the board revision being used for the reset button location). The device should load the EEPROM configuration.

11. Check that the settings loaded correctly by doing single-register reads (see step 6).

## Method 2: Copy Register Values and CRC to Clipboard

This method displays the EEPROM contents, which can be copied to the PC's clipboard and saved for programming outside of Timing Commander (this method itself does not write to the attached EEPROM). The following steps will perform this action:

1. Press the “EEPROM” button on the main window within Timing Commander to show the EEPROM popup window.

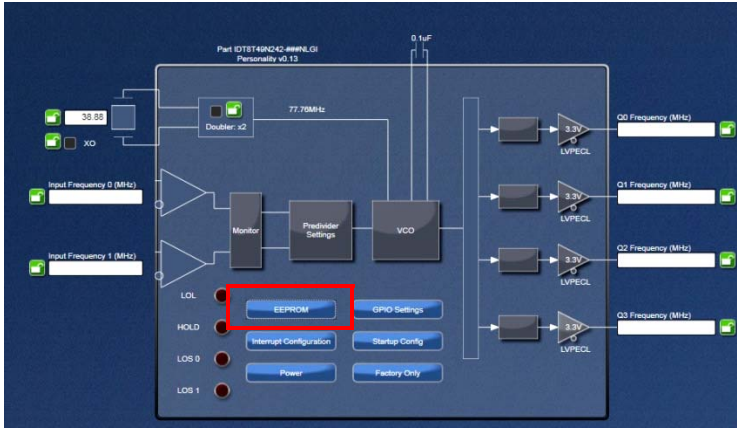

2. Press the “Calculate CRC” button in the EEPROM popup window.

This will refresh and display the register values and calculate the CRC value that needs to be appended to the end of the register data. The data can be highlighted and copied to the clipboard by right-clicking and selecting “copy” or pressing Ctrl+C.

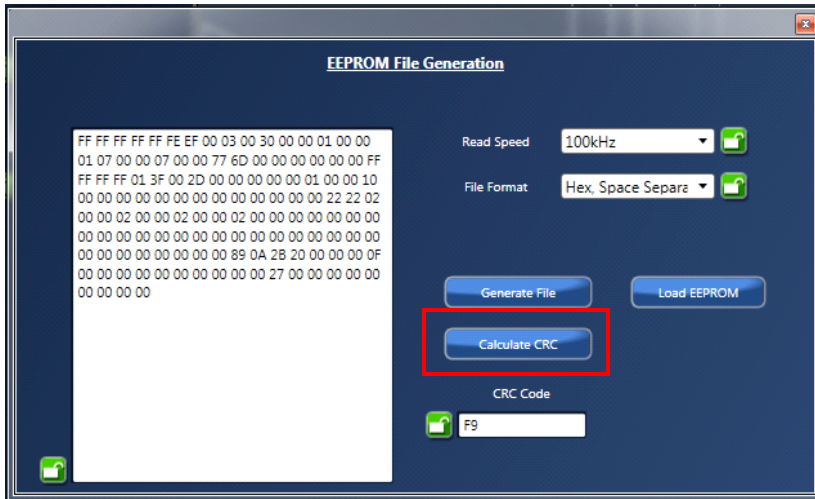

3. If the settings change, the registers must be re-queried by pressing the “Calculate CRC” button again.
4. The register contents may also be arbitrarily edited, and the CRC can then be calculated for the resulting settings. Changing the values in this manner will lock the displayed value to whatever is entered, so Timing Commander will no longer update the registers if something in the settings changes. Therefore, the field should be unlocked as soon as this feature is no longer being used.

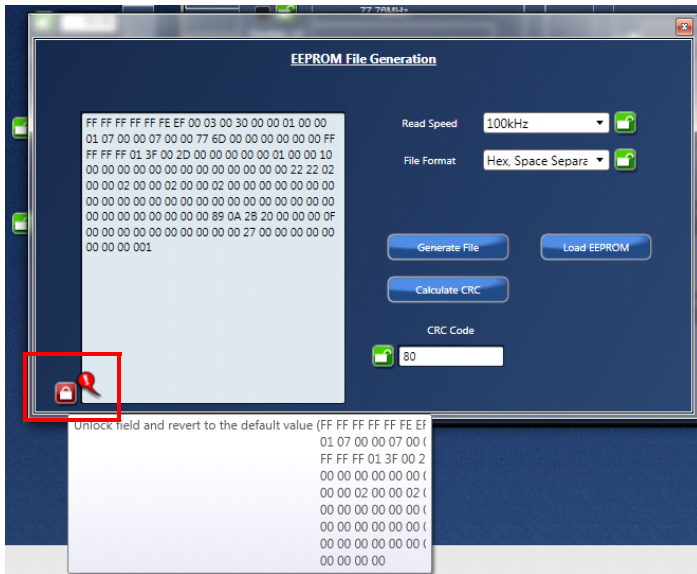

### Method 3: Save Register Values to a File

This method saves the register settings to a file, which can be used for EEPROM programming outside of Timing Commander (this method itself does not write to the attached EEPROM). The following steps will perform this action:

1. Press the “EEPROM” button on the main window to show the EEPROM popup window.

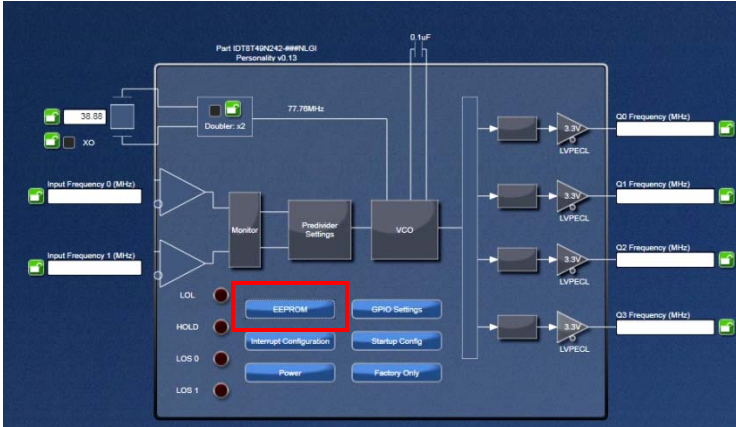

2. Select the file format (“Hex, Space Separated” appears like “01 02 03...”, “Hex, Contiguous” appears like “010203...”, and “Binary” is a binary file (no ASCII)). Then press “Generate File” and browse to a directory location in which to save the file. The file name will be automatically created. Press “Yes” to save the file. The file name will be displayed in a text box.

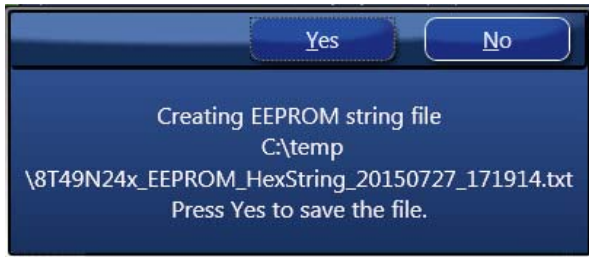
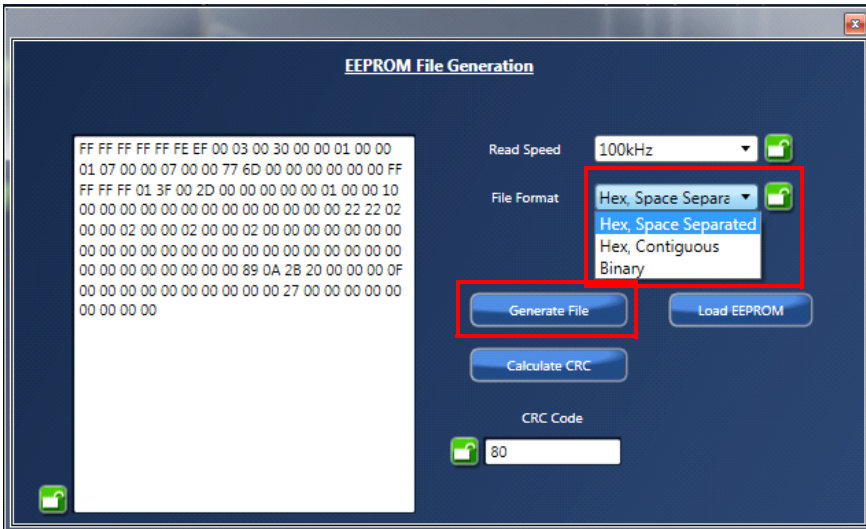



## Recovery from Incorrect Write

In case something goes wrong and the EEPROM is written incorrectly, the device may not boot correctly, and Timing Commander may be unable to connect to the device. If this occurs, the following steps should be used (See the User's Guide for the board revision that is being used):

1. Power down the evaluation board.
2. Remove the EEPROM from the socket.
3. Power up the Evaluation Board (the device will load the -998 configuration from OTP).
4. Connect to the board and use "WriteAll" to ensure the I2C communication is working correctly (steps 1–5 of [Method 1: Direct Write to EEPROM Using Timing Commander and the Evaluation Board](#)).
5. Without powering down, place the EEPROM back in the socket.
6. Write to the EEPROM (steps 7–11 of [Method 1: Direct Write to EEPROM Using Timing Commander and the Evaluation Board](#)).
7. The EEPROM should now have the correct settings programmed.

## Revision History

Revision Date	Description of Change
June 5, 2017	<ul style="list-style-type: none"><li>▪ Added support for the 8T49N240i device</li><li>▪ Converted the document to the latest template</li></ul>
August 7, 2015	Initial release.

## IMPORTANT NOTICE AND DISCLAIMER

RENESAS ELECTRONICS CORPORATION AND ITS SUBSIDIARIES (“RENESAS”) PROVIDES TECHNICAL SPECIFICATIONS AND RELIABILITY DATA (INCLUDING DATASHEETS), DESIGN RESOURCES (INCLUDING REFERENCE DESIGNS), APPLICATION OR OTHER DESIGN ADVICE, WEB TOOLS, SAFETY INFORMATION, AND OTHER RESOURCES “AS IS” AND WITH ALL FAULTS, AND DISCLAIMS ALL WARRANTIES, EXPRESS OR IMPLIED, INCLUDING, WITHOUT LIMITATION, ANY IMPLIED WARRANTIES OF MERCHANTABILITY, FITNESS FOR A PARTICULAR PURPOSE, OR NON-INFRINGEMENT OF THIRD PARTY INTELLECTUAL PROPERTY RIGHTS.

These resources are intended for developers skilled in the art designing with Renesas products. You are solely responsible for (1) selecting the appropriate products for your application, (2) designing, validating, and testing your application, and (3) ensuring your application meets applicable standards, and any other safety, security, or other requirements. These resources are subject to change without notice. Renesas grants you permission to use these resources only for development of an application that uses Renesas products. Other reproduction or use of these resources is strictly prohibited. No license is granted to any other Renesas intellectual property or to any third party intellectual property. Renesas disclaims responsibility for, and you will fully indemnify Renesas and its representatives against, any claims, damages, costs, losses, or liabilities arising out of your use of these resources. Renesas' products are provided only subject to Renesas' Terms and Conditions of Sale or other applicable terms agreed to in writing. No use of any Renesas resources expands or otherwise alters any applicable warranties or warranty disclaimers for these products.

(Disclaimer Rev.1.0 Mar 2020)

### Corporate Headquarters

TOYOSU FORESIA, 3-2-24 Toyosu,  
Koto-ku, Tokyo 135-0061, Japan  
[www.renesas.com](http://www.renesas.com)

### Contact Information

For further information on a product, technology, the most up-to-date version of a document, or your nearest sales office, please visit:  
[www.renesas.com/contact/](http://www.renesas.com/contact/)

### Trademarks

Renesas and the Renesas logo are trademarks of Renesas Electronics Corporation. All trademarks and registered trademarks are the property of their respective owners.