

Introduction

In a conventional LIU application, line side and chip side are coupled with a transformer. In a particular customer application, a capacitor instead of a transformer for the same coupling is desired. This test is to explore if a capacitor coupling is acceptable.

Test Platform

A simple test platform is setup as the following. The transformer of 82V2082 receiver is replaced with two capacitors (one for RTIP and one for RRING). By using different capacitance, both waveforms and BERT testing are compared and verified.

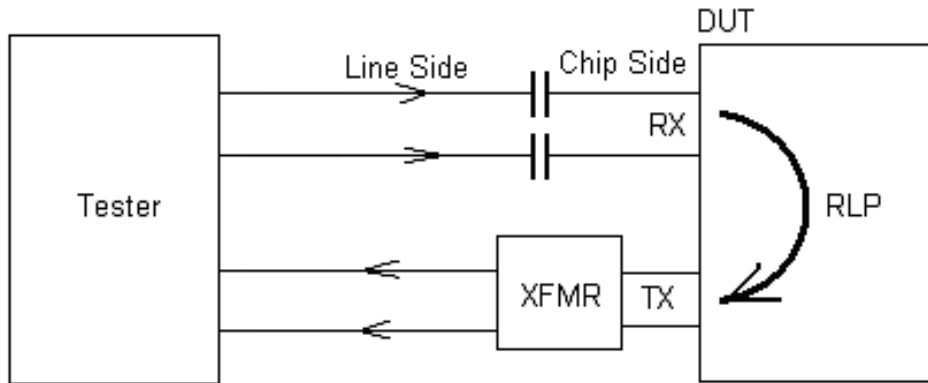

Test Results

[A] Waveform comparisons

Waveforms of transformer coupling and capacitor coupling are compared. Please see waveform screen captures below.

[1] Transformer coupling waveforms

Line side:

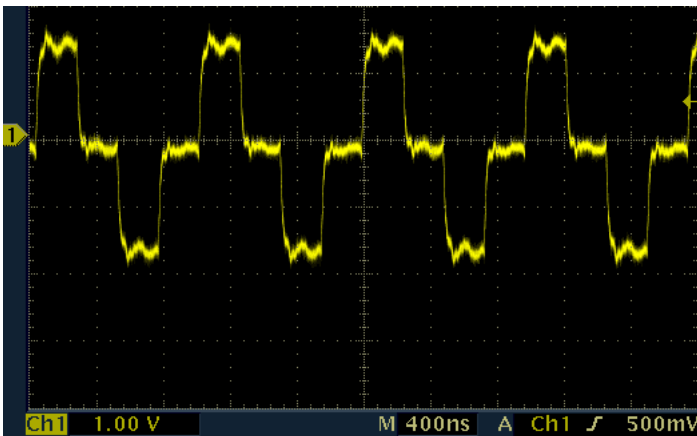

Chip side:

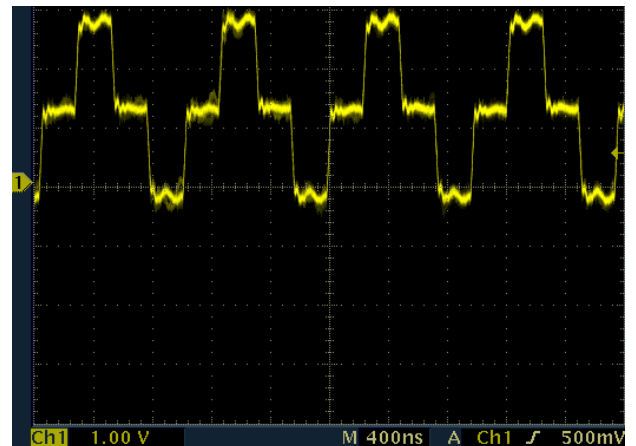

[2] Capacitor coupling waveforms

6.8μF, Line side:

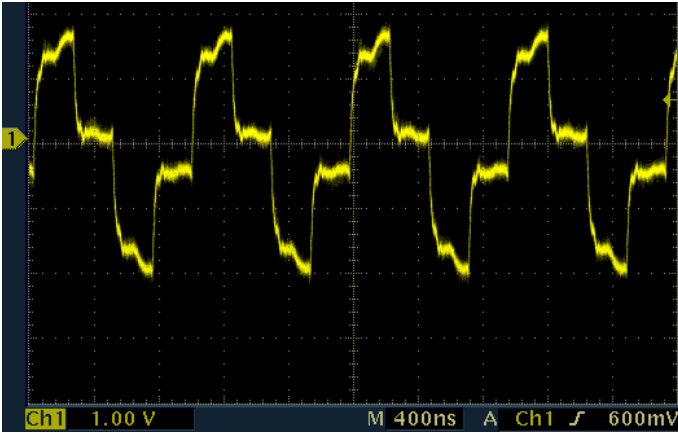

6.8μF, Chip side:

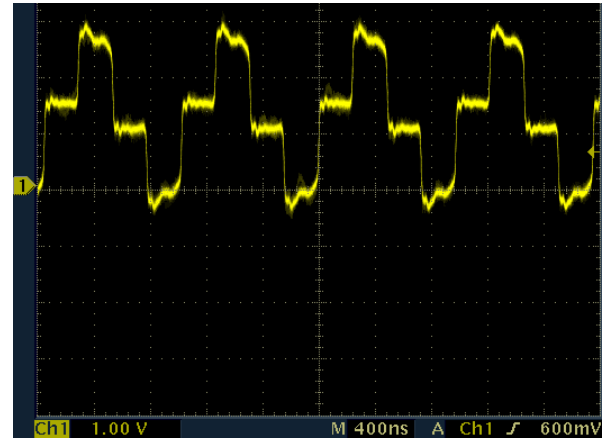

22μF, Line side:

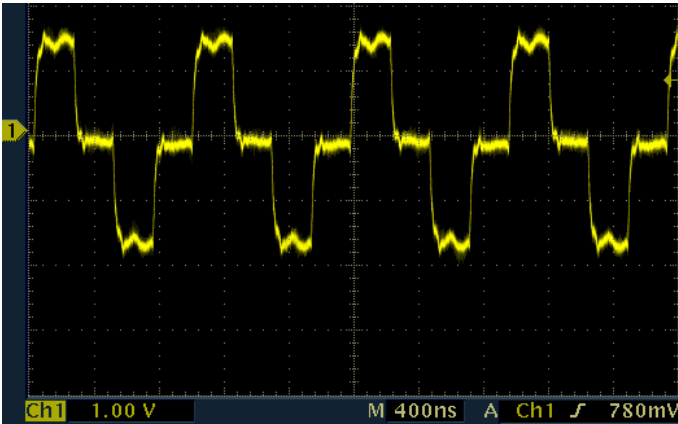

22μF, Chip side:

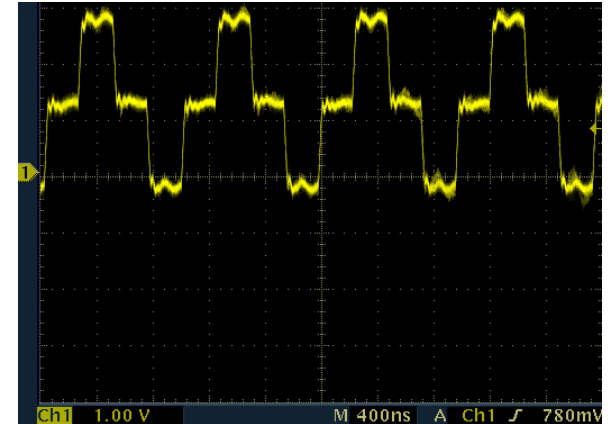

[B] BERT Testing

Other than waveform comparison, BERT was done to functionally test if any bit errors occur with capacitor coupling. The results are shown in the following table.

Table 1: BER Test Observation

Data Pattern	Transformer Coupling	6.8μF Capacitor Coupling	22μF Capacitor Coupling
2 ¹¹ - 1	Error Free	Error Free	Error Free
2 ¹⁵ - 1	Error Free	Error Free	Error Free
2 ²⁰ - 1	Error Free	Error Free	Error Free
2 ²³ - 1	Error Free	Error Free	Error Free

Analytical Comments

1. From the test results, it appears capacitor coupling can be used for LIU receiver;
2. From waveform comparisons, big capacitance coupling (22 μ F vs. 6.8 μ F) generates better waveforms with respect to transformer coupling.
3. The effect of capacitor coupling on Return Loss was not tested in this test.
4. Please note: capacitors used in this test is of Z5U type, which has a wide variation (-85%~+20%) from its nominal capacitance. Ceramic capacitors with narrow variations, such as X7R/X5R/C0G, are recommended.

IMPORTANT NOTICE AND DISCLAIMER

RENESAS ELECTRONICS CORPORATION AND ITS SUBSIDIARIES (“RENESAS”) PROVIDES TECHNICAL SPECIFICATIONS AND RELIABILITY DATA (INCLUDING DATASHEETS), DESIGN RESOURCES (INCLUDING REFERENCE DESIGNS), APPLICATION OR OTHER DESIGN ADVICE, WEB TOOLS, SAFETY INFORMATION, AND OTHER RESOURCES “AS IS” AND WITH ALL FAULTS, AND DISCLAIMS ALL WARRANTIES, EXPRESS OR IMPLIED, INCLUDING, WITHOUT LIMITATION, ANY IMPLIED WARRANTIES OF MERCHANTABILITY, FITNESS FOR A PARTICULAR PURPOSE, OR NON-INFRINGEMENT OF THIRD PARTY INTELLECTUAL PROPERTY RIGHTS.

These resources are intended for developers skilled in the art designing with Renesas products. You are solely responsible for (1) selecting the appropriate products for your application, (2) designing, validating, and testing your application, and (3) ensuring your application meets applicable standards, and any other safety, security, or other requirements. These resources are subject to change without notice. Renesas grants you permission to use these resources only for development of an application that uses Renesas products. Other reproduction or use of these resources is strictly prohibited. No license is granted to any other Renesas intellectual property or to any third party intellectual property. Renesas disclaims responsibility for, and you will fully indemnify Renesas and its representatives against, any claims, damages, costs, losses, or liabilities arising out of your use of these resources. Renesas' products are provided only subject to Renesas' Terms and Conditions of Sale or other applicable terms agreed to in writing. No use of any Renesas resources expands or otherwise alters any applicable warranties or warranty disclaimers for these products.

(Disclaimer Rev.1.0 Mar 2020)

Corporate Headquarters

TOYOSU FORESIA, 3-2-24 Toyosu,
Koto-ku, Tokyo 135-0061, Japan
www.renesas.com

Contact Information

For further information on a product, technology, the most up-to-date version of a document, or your nearest sales office, please visit:
www.renesas.com/contact/

Trademarks

Renesas and the Renesas logo are trademarks of Renesas Electronics Corporation. All trademarks and registered trademarks are the property of their respective owners.