

### IDT ADVANTAGE

- 5 V (CODEC & SLIC) and Battery Power Supply
- DSP-Based: Single LineCard Design Meets Different Standards Worldwide
- Internal Polarity Reversal
- On-Chip Thermal Management
- Less External Components
- High Reliability and Robust (ESD > 2000 V, Latch-up > 100 mA)
- Cost-Effective

### OTHER FEATURES OF THE SLIC:

- Slic operating states: Active, Reverse Active, Ringing, Standby and Disconnect
- Low Standby power consumption (35 mW)
- -19 V to -58 V Battery Supply
- On-Hook Transmission

- Two-Wire impedance set by single external impedance
  - Programmable constant-current feed
  - Programmable loop-detect threshold and ring-trip detect threshold
  - Three on-chip relay drivers and relay snubbers
- Programmable digital filters adapting to different requirements:
- AC impedance matching
  - Transhybrid balance
  - Frequency response correction
  - Gain adjustment
- Programmable A/u-law compressed or linear code conversion
  - Supports two programmable PCM buses and MPI interface
  - 7 SLIC signaling pins per channel
  - Two programmable dual tone generators per channel
  - Two programmable chopper clocks
  - Advanced test capability (level metering and programmable loopbacks)

### TOTAL SOLUTION BLOCK DIAGRAM

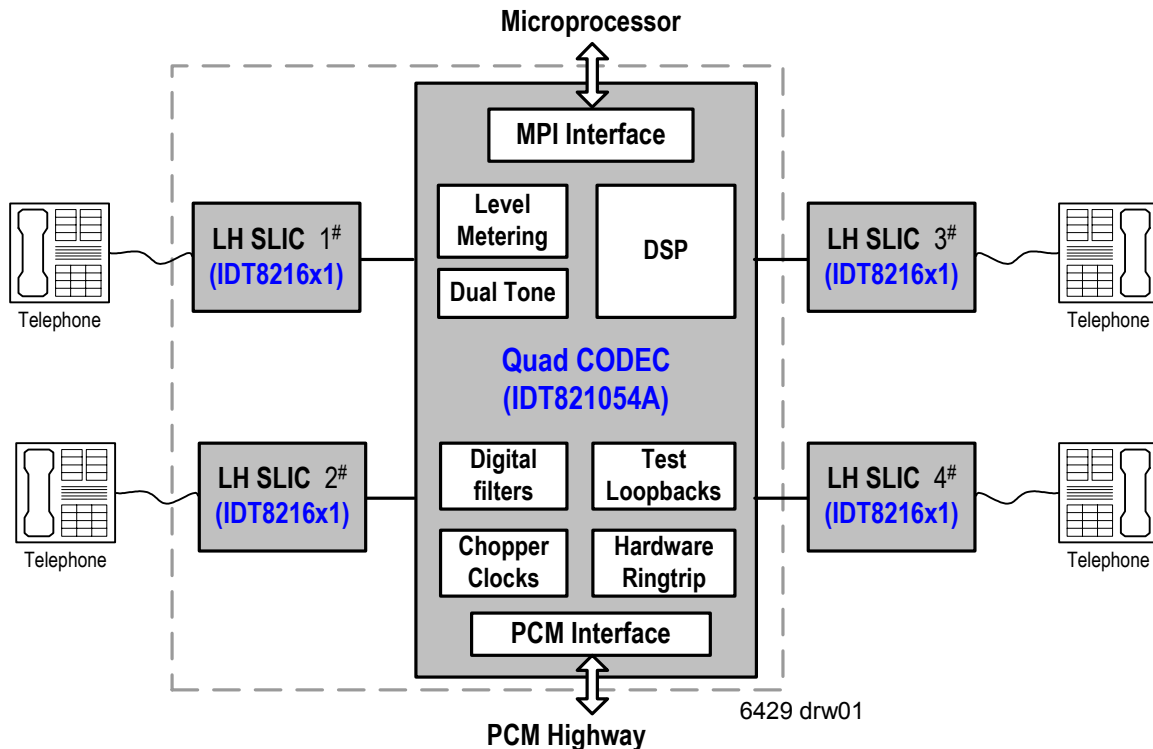

# SLIC FUNCTIONAL BLOCK DIAGRAM

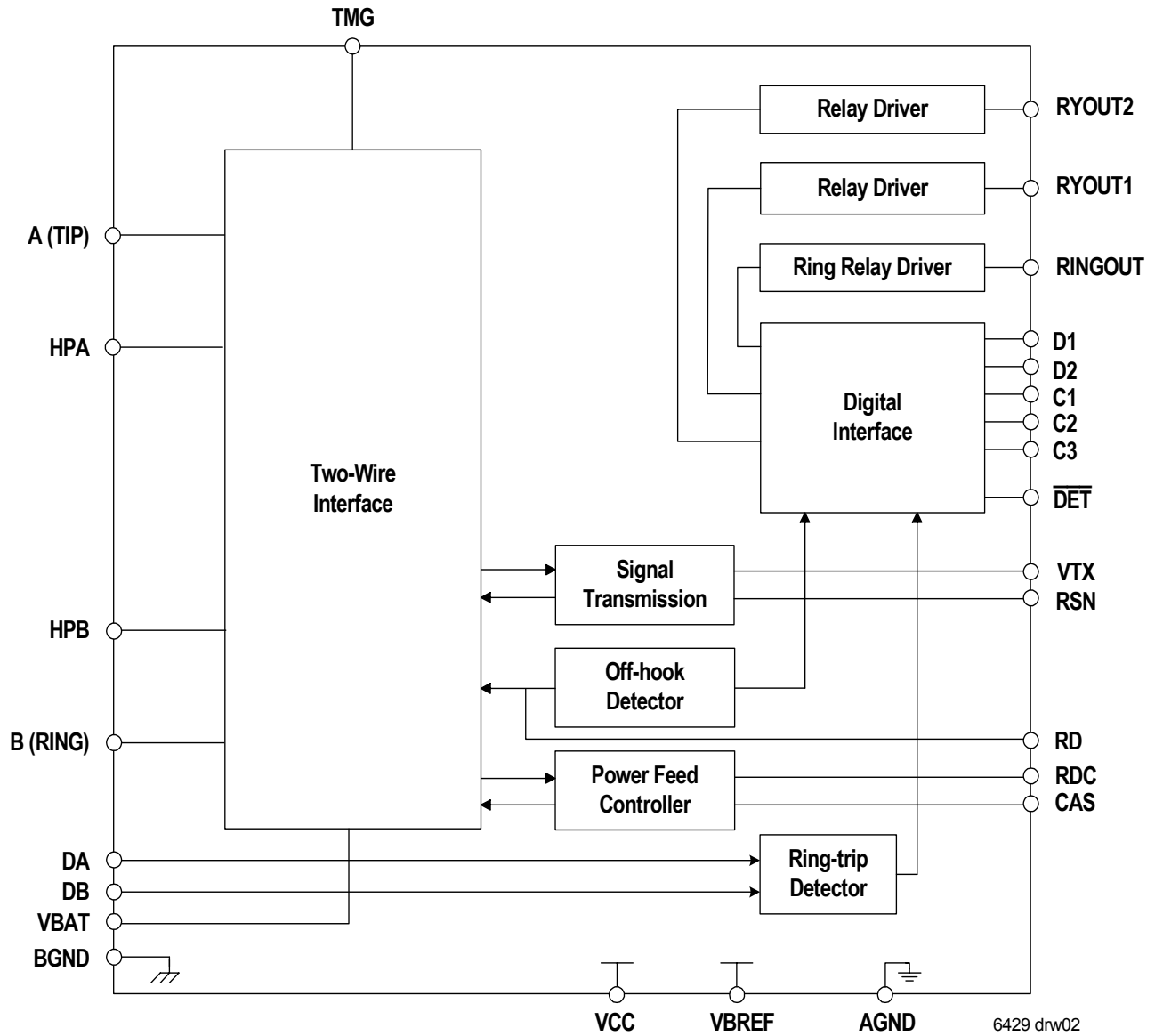

# CODEC FUNCTIONAL BLOCK PROGRAM

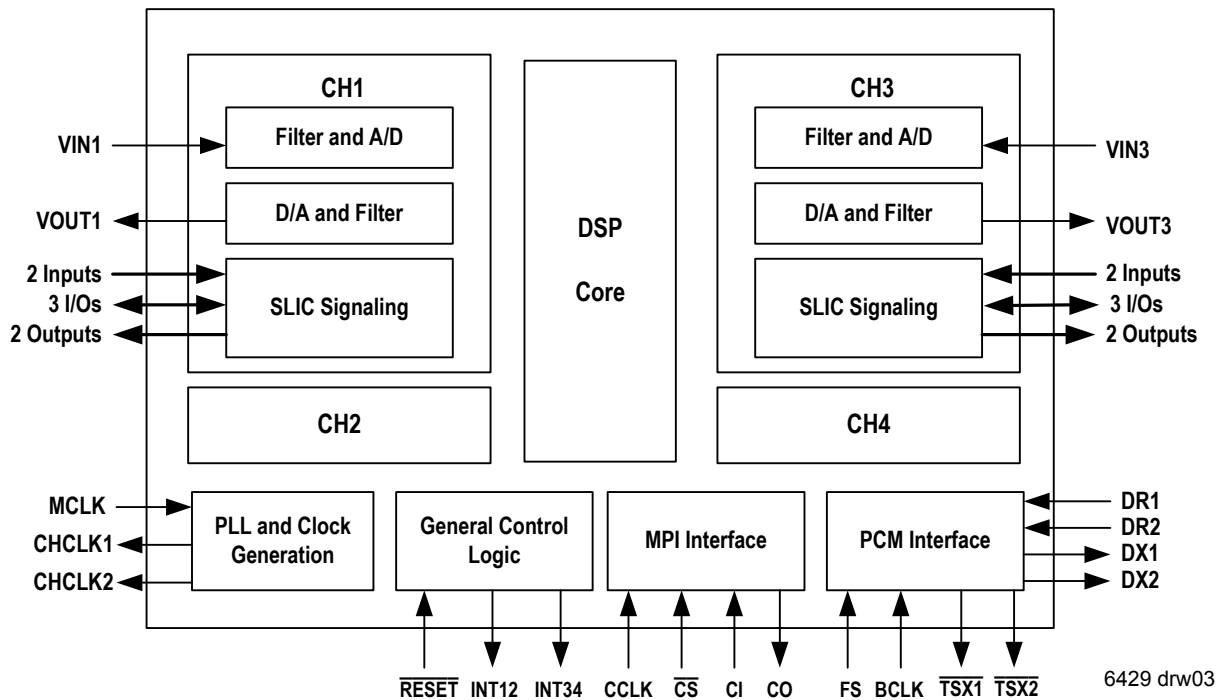

6429 drw03

# CODEC SIGNAL FLOW DIAGRAM

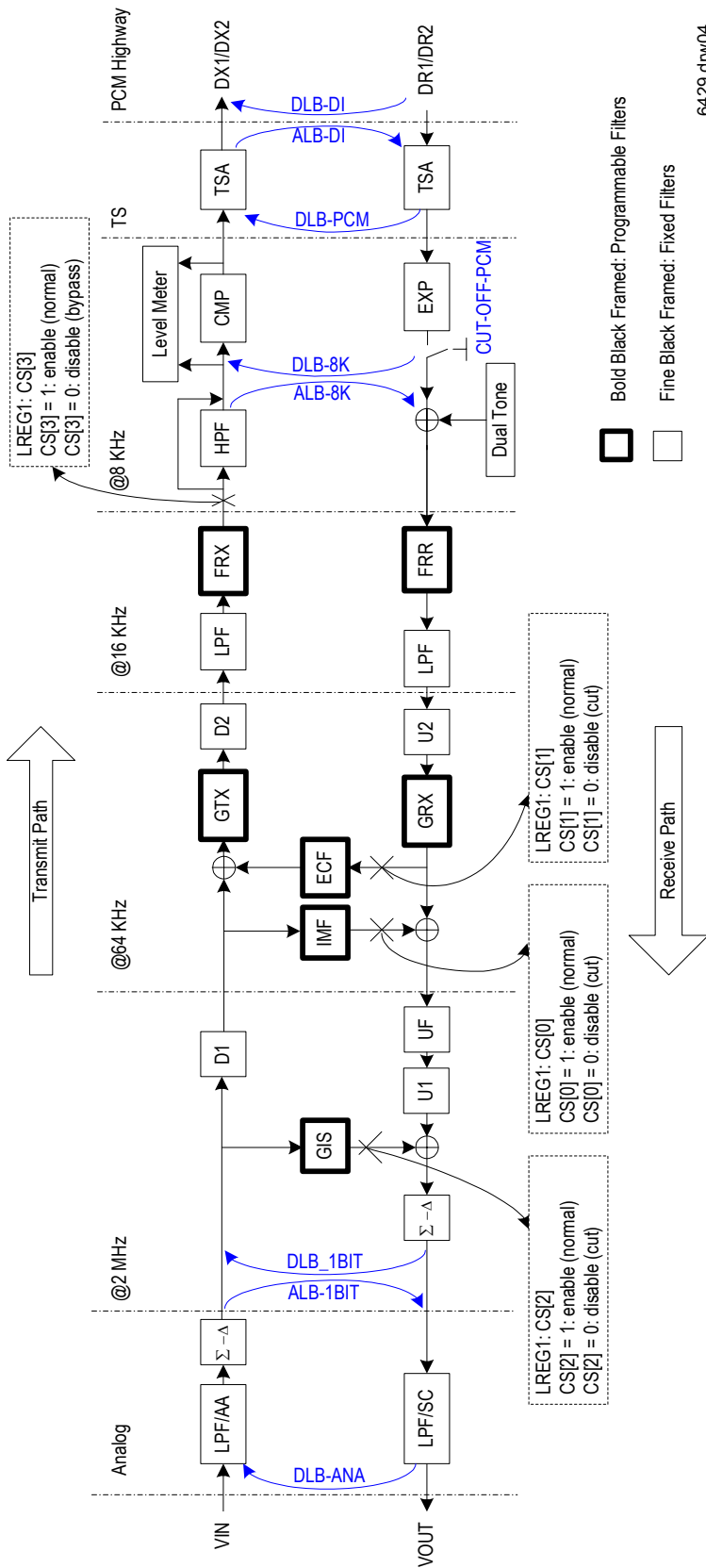

6429 drw04

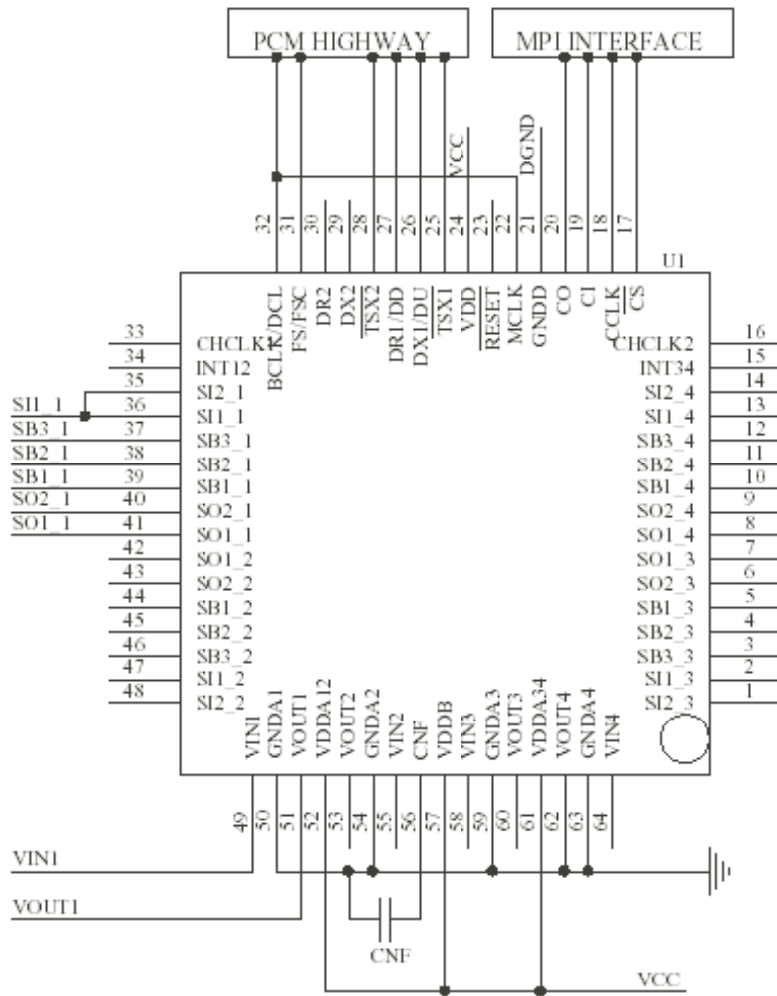

6429 drw24b

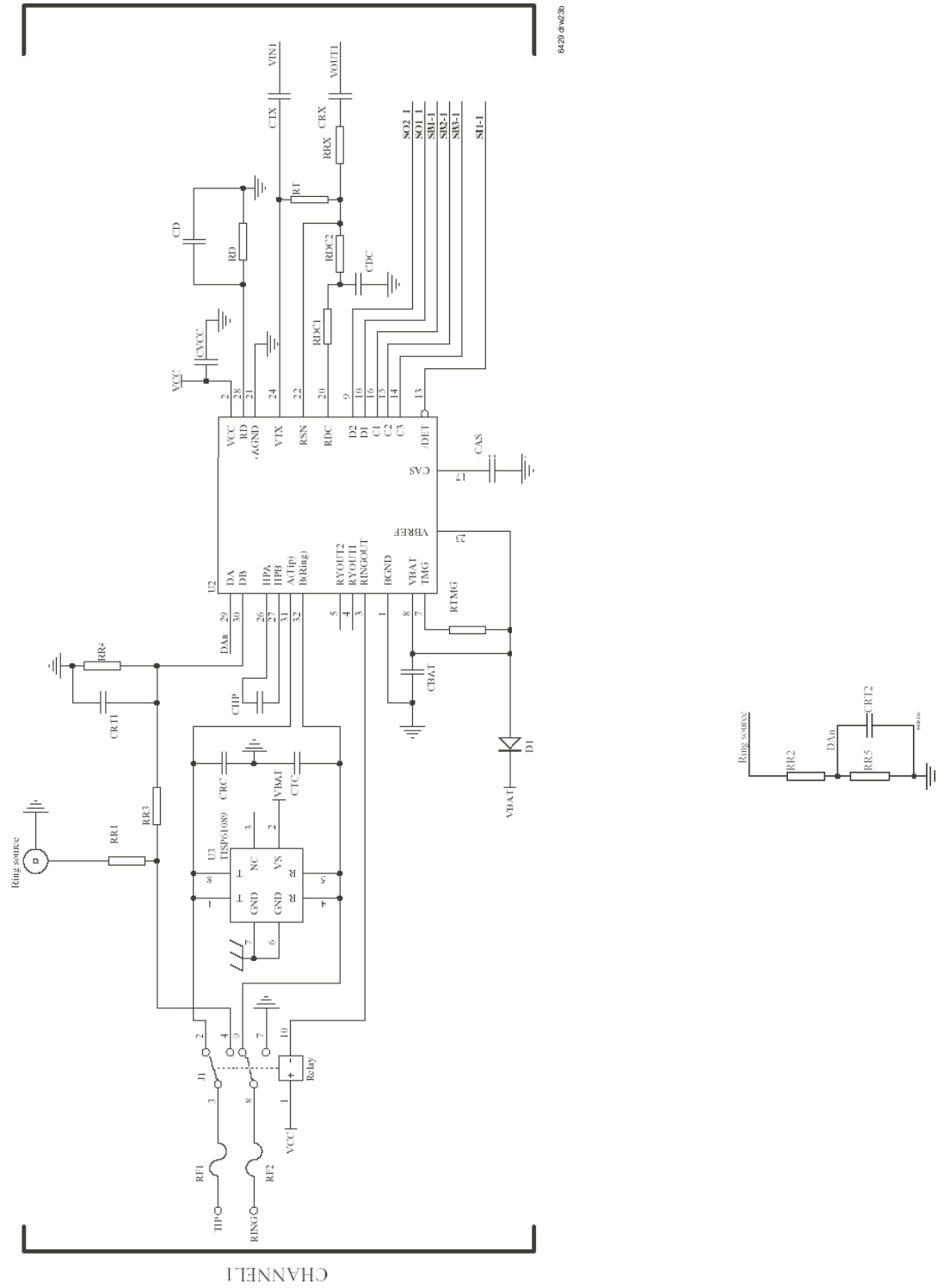

6429 drv23b

**COMPONENTS LIST:**

Designator	Description	Part Type	Precision	Maximum Power/Voltage	Other
CAS	Capacitor	0.1uF	10%	100V	
CNF	Capacitor	0.1uF	10%	16V	
CRC	Capacitor	2.2nF	10%	100V	
CTC	Capacitor	2.2nF	10%	100V	
CTX	Capacitor	0.1uF	10%	16V	
CRX	Capacitor	0.1uF	10%	16V	
CD	Capacitor	0.01uF	10%	16V	
CVCC	Capacitor	0.1uF	20%	16V	
CBAT	Capacitor	0.01uF	20%	100V	
CHP	Capacitor	0.27uF	10%	100V	
CDC	Capacitor	0.27uF	10%	16V	
CRT1	Capacitor	33nF	10%	100V	
CRT2	Capacitor	33nF	10%	100V	
RR2	Resister	4M	10%	1/4W	
RR3	Resister	3.4M	10%	1/4W	
RTMG	Resister	2K	10%	1W	
RR5	Resister	3.4M	10%	1/4W	
RDC2	Resister	27K	1%	1/4W	
RDC1	Resister	27K	1%	1/4W	
RD	Resister	36K	1%	1/4W	
RRX	Resister	120K	1%	1/4W	
RT	Resister	120K	1%	1/4W	
RR1	Resister	800	10%	1W	
RR4	Resister	4M	10%	1/4W	
RF1	Fuse	50	1%	1W	
RF2	Fuse	50	1%	1W	
D1	DIODE			100V, 100mA	
U1	IDT821054A				
U2	IDT8216x1				
J1	Relay				

## COEFFICIENTS IN DSP RAM 600Ω

The system target gain from tip / ring to digital port: 0 dB

The system target gain from digital port to tip / ring: 0 dB

Coefficients in the DSP Ram From low address to high address:

IMF Ram:	C6	FD	6B	04	00	00	00	00	00	00	00	00	00	00	00
ECF Ram:	42	F4	A4	15	00	00	00	00	00	00	04	54	CE	E0	00
GIS + Dual Tone Ram:	00	00	08	FC	00	00	00	00	00	00	00	00	00	00	00
FRX + GTX Ram:	70	00	37	F3	16	20	16	20	37	F3	70	00	99	31	F0
FRR + GRX Ram:	38	01	13	00	0B	3E	0B	3E	13	00	38	01	CE	84	55

1. Select filter coefficients in the Coe-RAM by setting LREG1 to FFH;
2. Set the analog gain of A/D to 6 dB by setting the GAD bit in LREG9 to "1";
3. Set the analog gain of D/A to 0 dB by setting the GDA bit in LREG9 to "0".



## Total Distortion - A55 (A2D)

(For 600Ω impedance, system target gain of A2D: 0dB; system target gain of D2A: 0dB)

### Data

Level(dBm0)	Channel
-55	18.65
-53	20.06
-51	21.54
-49	23.39
-47	26.21
-45	27.58
-43	29.75
-41	31.69
-39	33.4
-37	35.78
-35	37.79
-33	38.39
-31	38.38
-29	39.5
-27	41.55
-25	39.22
-23	40.69
-21	42.68
-19	39.56
-17	41.21
-15	43.1
-13	39.81
-11	41.05
-9	43.25
-7	40.09
-5	40.88
-3	43.12
-1	40.31
1	40.78
3	43.42

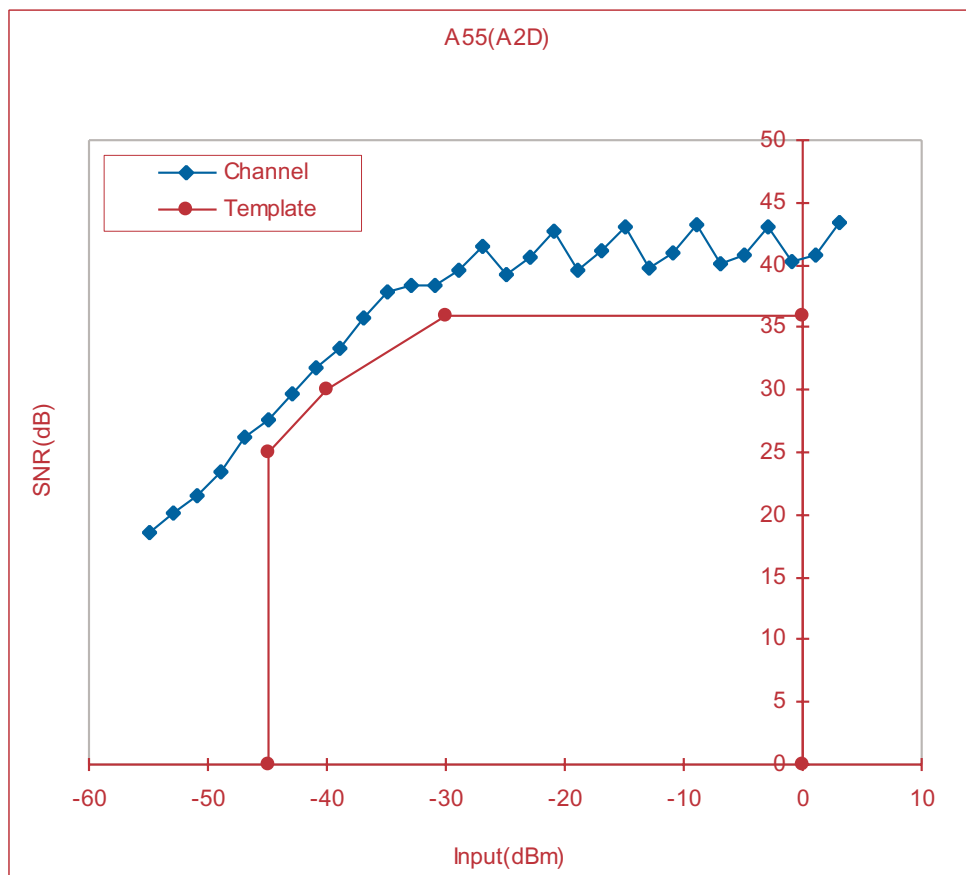

6429drw05

## Total Distortion - A55 (D2A)

(For 600Ω impedance, system target gain of A2D: 0dB; system target gain of D2A: 0dB)

### Data

Level(dBm0)	Channel
-55	18.48
-53	20.32
-51	21.59
-49	23.62
-47	26.41
-45	28.21
-43	30.16
-41	33.6
-39	35.22
-37	36.72
-35	39.02
-33	41.41
-31	39.02
-29	41.19
-27	42.63
-25	39.47
-23	41.31
-21	43.28
-19	39.8
-17	41
-15	43.06
-13	40.41
-11	40.73
-9	43.56
-7	40.21
-5	40.63
-3	43.42
-1	40.51
1	41.04
3	43.3

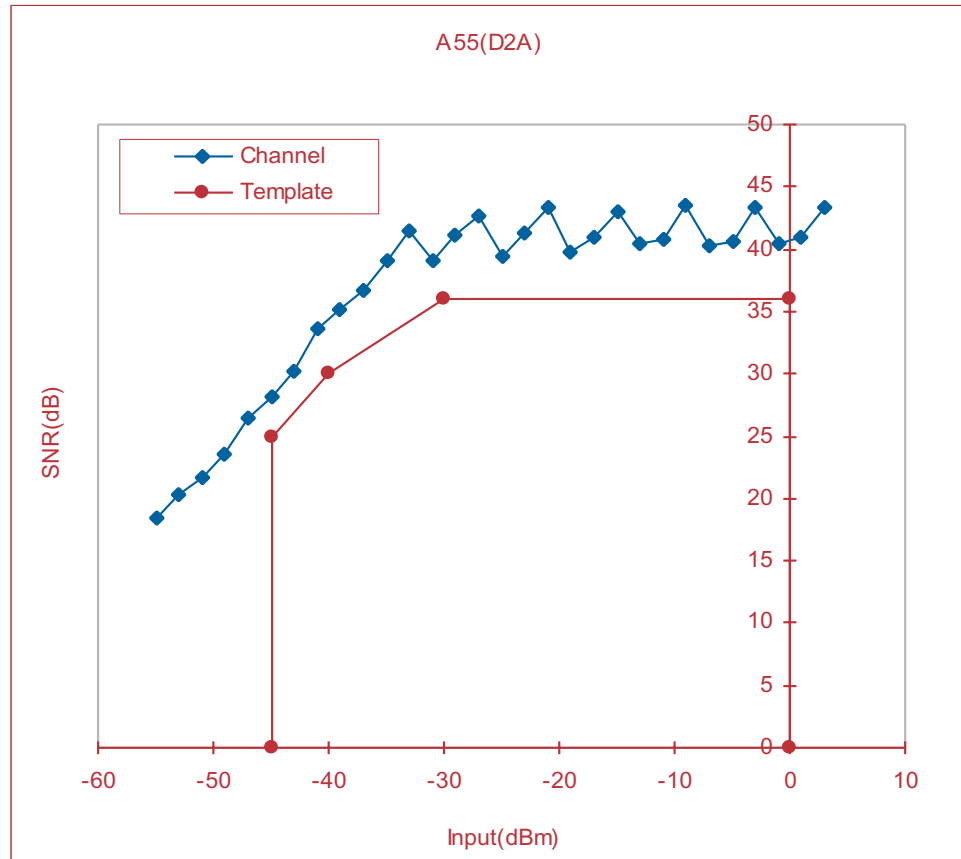

6429drw06

## COEFFICIENTS IN DSP RAM 600Ω

The system target gain from tip / ring to digital port: 0 dB

The system target gain from digital port to tip / ring: -3.5 dB

Coefficients in the DSP Ram From low address to high address:

IMF Ram:	C6	FD	6B	04	00	00	00	00	00	00	00	00	00	00	00	00
ECF Ram:	42	F4	A4	15	00	00	00	00	00	00	04	54	CE	E0	00	00
GIS + Dual Tone Ram:	00	00	08	FC	00	00	00	00	00	00	00	00	00	00	00	00
FRX + GTX Ram:	70	00	37	F3	16	20	15	20	37	F3	70	00	99	31	F0	07
FRX + GRX Ram:	38	01	13	00	0B	3E	0B	3E	13	00	38	01	CE	84	9A	13

1. Select filter coefficients in the Coe-RAM by setting LREG1 to FFH;
2. Set the analog gain of A/D to 6 dB by setting the GAD bit in LREG9 to "1";
3. Set the analog gain of D/A to 0 dB by setting the GDA bit in LREG9 to "0".

## Total Distortion - A55 (A2D)

(For 600W impedance, system target gain of A2D: 0dB; system target gain of D2A: -3.5dB)

### Data

Level (dBm0)	Channel
-55	18.48
-53	20.32
-51	21.59
-49	23.62
-47	26.41
-45	28.21
-43	30.16
-41	33.6
-39	35.22
-37	36.72
-35	39.02
-33	41.41
-31	39.02
-29	41.19
-27	42.63
-25	39.47
-23	41.31
-21	43.28
-19	39.8
-17	41
-15	43.06
-13	40.41
-11	40.73
-9	43.56
-7	40.21
-5	40.63
-3	43.42
-1	40.51
1	41.04
3	43.3

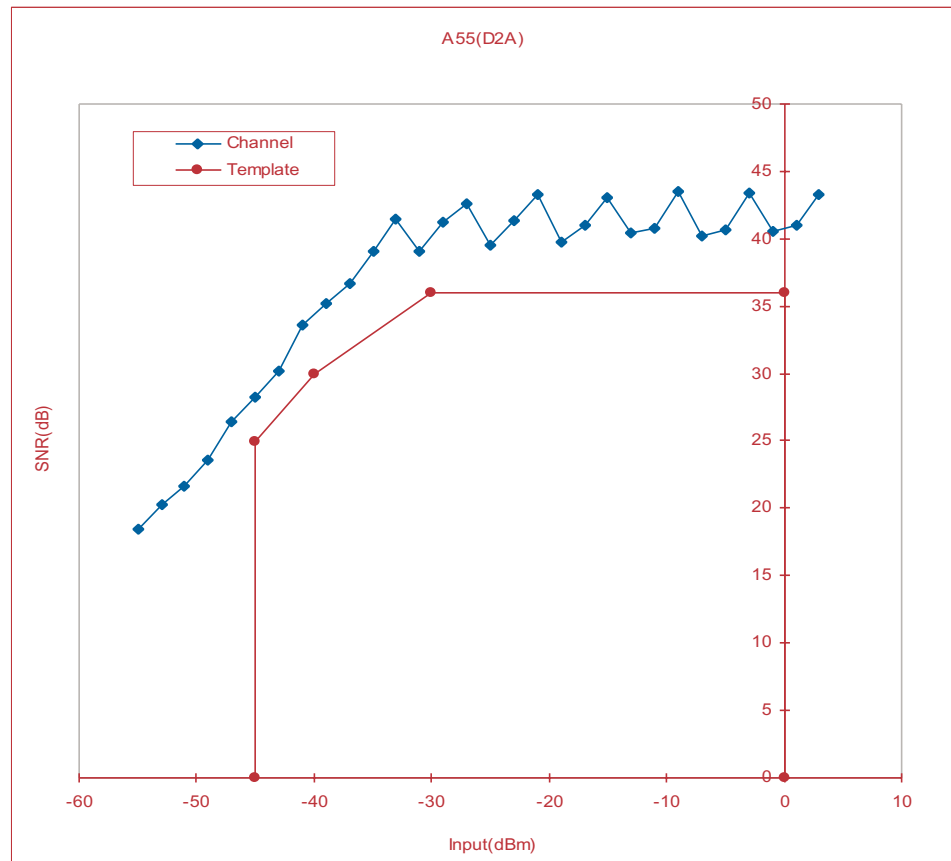

6429drw07

### Total Distortion - A55 (D2A)

(For 600Ω impedance, system target gain of A2D: 0dB; system target gain of D2A: -.3.5dB)

Data

Level (dBm0)	Channel
-55	17.88
-53	19.96
-51	21.1
-49	23.29
-47	25.86
-45	27.71
-43	29.54
-41	32.86
-39	34.63
-37	36.23
-35	38.6
-33	40.72
-31	38.95
-29	41.04
-27	42.49
-25	39.39
-23	41.24
-21	43.19
-19	39.77
-17	40.97
-15	43.05
-13	40.4
-11	40.73
-9	43.55
-7	40.21
-5	40.65
-3	43.41
-1	40.52
1	41.04
3	43.31

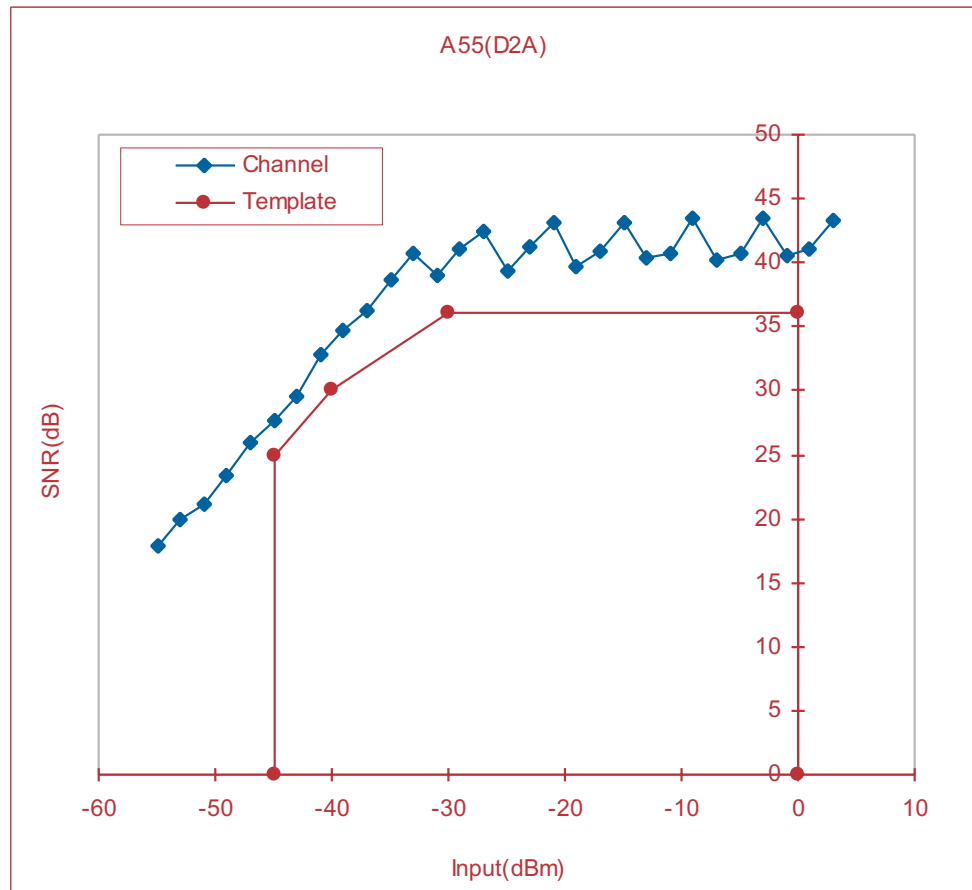

6429drw08

## COEFFICIENTS IN DSP RAM 600Ω

The system target gain from tip / ring to digital port: 0 dB

The system target gain from digital port to tip / ring: -7 dB

Coefficients in the DSP Ram From low address to high address:

IMF Ram:	F5	01	C1	03	00	00	00	00	00	00	00	00	00	00	00	00
ECF Ram:	01	FA	0A	0B	00	00	00	00	00	00	65	53	4C	E1	00	00
GIS + Dual Tone Ram:	00	00	18	F4	00	00	00	00	00	00	00	00	00	00	00	00
FRX + GTX Ram:	6E	00	19	F3	31	20	31	20	19	F3	6E	00	99	31	E2	07
FRR + GRX Ram:	1C	01	04	00	28	3E	28	3E	04	00	1C	01	CE	84	24	1A

1. Select filter coefficients in the Coe-RAM by setting LREG1 to FFH;
2. Set the analog gain of A/D to 6 dB by setting the GAD bit in LREG9 to "1";
3. Set the analog gain of D/A to -6 dB by setting the GDA bit in LREG9 to "1".

## Total Distortion - A55 (A2D)

(For 600Ω impedance, system target gain of A2D: 0dB; system target gain of D2A: -7dB)

### Data

Level (dBm0)	Channel
-55	19.64
-53	21.06
-51	21.85
-49	23.82
-47	27.16
-45	28.23
-43	30.36
-41	32.83
-39	34.55
-37	36.46
-35	38.87
-33	39.48
-31	38.92
-29	41.15
-27	42.11
-25	39.42
-23	41.23
-21	43.09
-19	39.92
-17	40.89
-15	43.19
-13	40.3
-11	40.8
-9	43.45
-7	40.39
-5	40.62
-3	43.42
-1	40.53
1	41.01
3	43.11

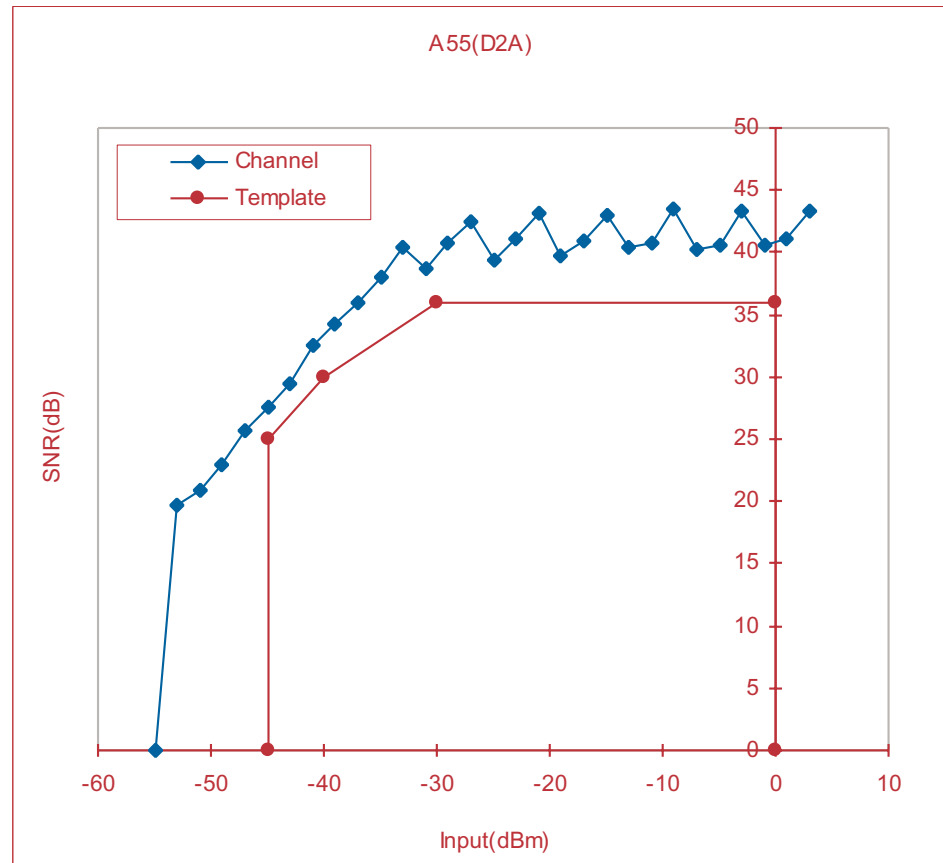

6429drw09

### Total Distortion - A55 (D2A)

(For 600Ω impedance, system target gain of A2D: 0dB; system target gain of D2A: -.7dB)

**Data**

Level (dBm0)	Channel
-55	17.73
-53	19.67
-51	20.96
-49	23.01
-47	25.69
-45	27.52
-43	29.45
-41	32.56
-39	34.28
-37	36.02
-35	38.08
-33	40.33
-31	38.66
-29	40.79
-27	42.45
-25	39.30
-23	41.16
-21	43.17
-19	39.78
-17	40.94
-15	43.02
-13	40.37
-11	40.70
-9	43.52
-7	40.20
-5	40.63
-3	43.38
-1	40.50
1	41.02
3	43.28

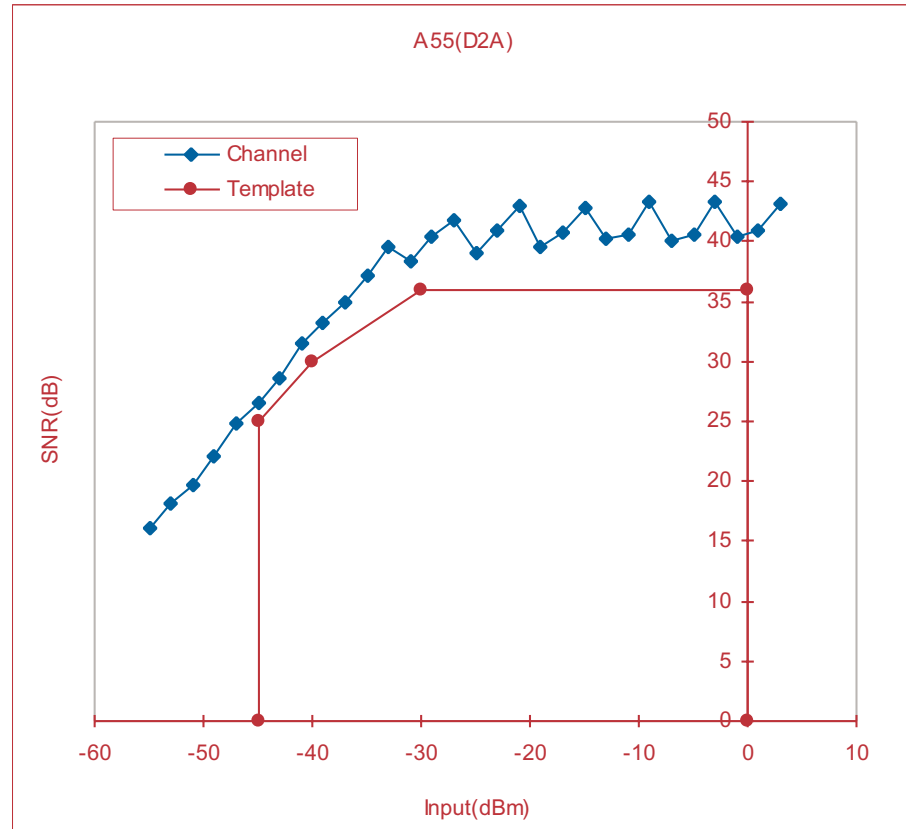

6429drw10



## COEFFICIENTS IN DSP RAM 900Ω

The system target gain from tip / ring to digital port: 0 dB

The system target gain from digital port to tip / ring: 0 dB

Coefficients in the DSP Ram From low address to high address:

IMF Ram:	0F	26	0F	EE	00	00	00	00	00	00	00	00	00	00	00	
ECF Ram:	CE	F5	CC	11	00	00	00	00	00	00	80	53	F7	E0	00	
GIS + Dual Tone Ram:	00	00	B8	A4	00	00	00	00	00	00	00	00	00	00	00	
FRX + GTX Ram:	3E	FF	42	F2	04	1F	04	1F	42	F2	3E	FF	66	3E	95	0C
FRR + GRX Ram:	CD	01	33	F3	0F	22	0F	22	33	F3	CD	01	CD	24	E6	16

1. Select filter coefficients in the Coe-RAM by setting LREG1 to FFH;
2. Set the analog gain of A/D to 0 dB by setting the GAD bit in LREG9 to "0";
3. Set the analog gain of D/A to 0 dB by setting the GDA bit in LREG9 to "0".

### Total Distortion - A55 (A2D)

(For 900Ω impedance, system target gain of A2D: 0dB; system target gain of D2A: 0dB)

Data

Level (dBm0)	Channel
-55	19.44
-53	20.4
-51	21.52
-49	23.55
-47	26.48
-45	27.71
-43	29.85
-41	32.78
-39	34.21
-37	35.95
-35	37.97
-33	40.44
-31	39.11
-29	40.05
-27	42.77
-25	40.25
-23	40.82
-21	43.03
-19	40.7
-17	41.41
-15	43.02
-13	40.98
-11	41.74
-9	42.64
-7	41.01
-5	41.95
-3	42.54
-1	40.94
1	42.19
3	42.06

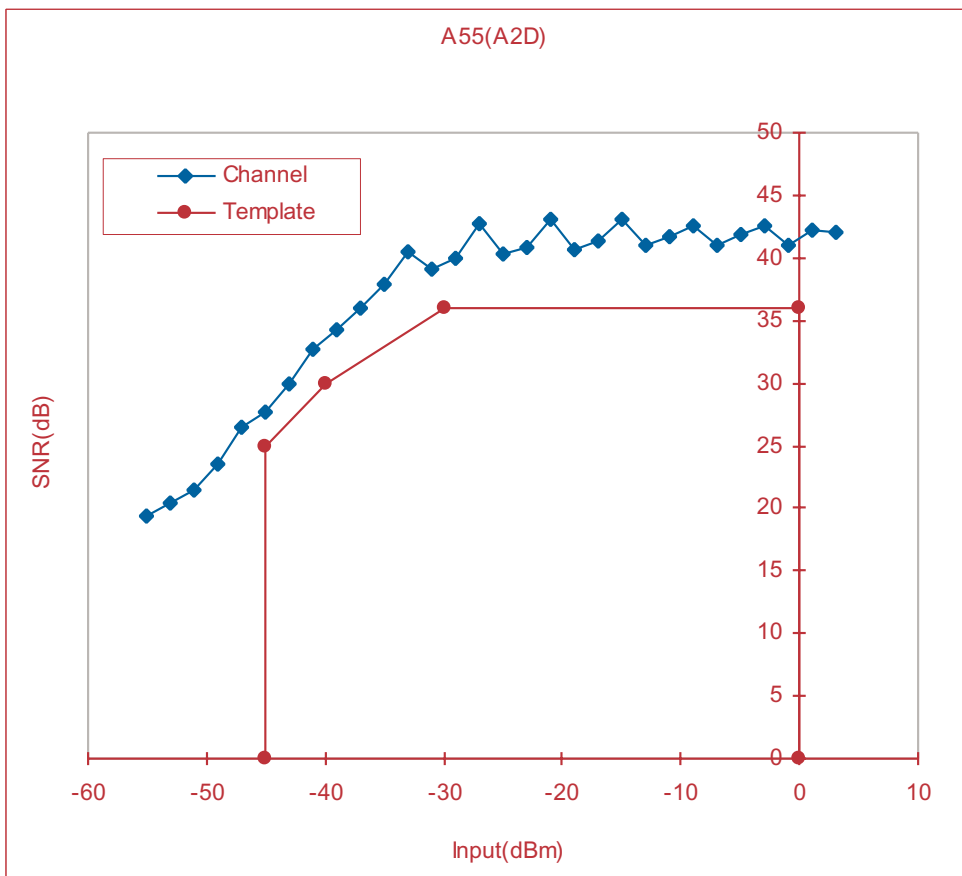

6429drw11

## Total Distortion - A55 (D2A)

(For 900Ω impedance, system target gain of A2D: 0dB; system target gain of D2A: 0dB)

### Data

Level (dBm0)	Channel
-55	18.36
-53	20.19
-51	21.44
-49	23.49
-47	26.23
-45	28.29
-43	30.03
-41	33.47
-39	34.97
-37	35.58
-35	38.79
-33	41.14
-31	39.05
-29	41.14
-27	42.64
-25	39.4
-23	41.2
-21	43.22
-19	39.73
-17	40.92
-15	43
-13	40.32
-11	40.67
-9	43.49
-7	40.14
-5	41.58
-3	43.35
-1	40.46
1	40.97
3	42.23

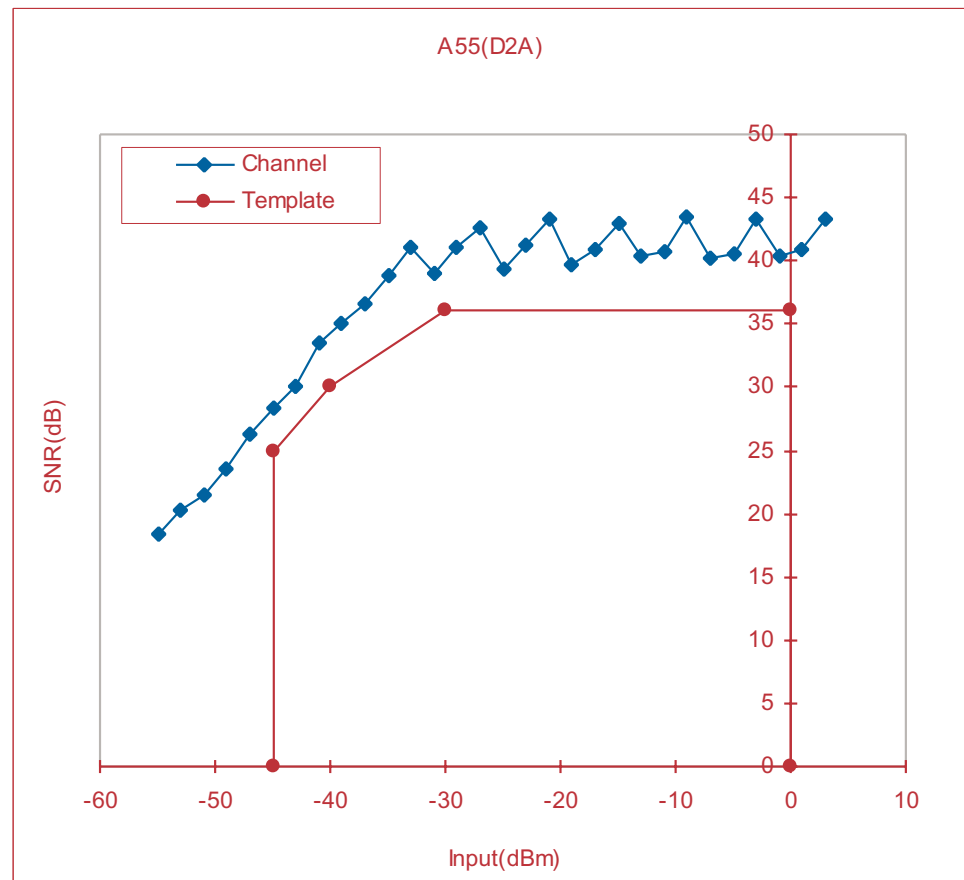

6429drw12

## COEFFICIENTS IN DSP RAM 900Ω

The system target gain from tip / ring to digital port: 0 dB

The system target gain from digital port to tip / ring: -3.5 dB

Coefficients in the DSP Ram From low address to high address:

IMF Ram:	0F	26	0F	EE	00	00	00	00	00	00	00	00	00	00	00
ECF Ram:	CE	F5	CC	11	00	00	00	00	00	00	80	53	F7	E0	00
GIS + Dual Tone Ram:	00	00	B8	A4	00	00	00	00	00	00	00	00	00	00	00
FRX + GTX Ram:	3E	FF	42	F2	04	1F	04	1F	42	F2	3E	FF	66	3E	95
FRR + GRX Ram:	CD	01	33	F3	0F	22	0F	22	33	F3	CD	01	CD	24	4E

1. Select filter coefficients in the Coe-RAM by setting LREG1 to FFH;
2. Set the analog gain of A/D to 0 dB by setting the GAD bit in LREG9 to "0";
3. Set the analog gain of D/A to 0 dB by setting the GDA bit in LREG9 to "0".

### Total Distortion - A55 (A2D)

(For 900Ω impedance, system target gain of A2D: 0dB; system target gain of D2A: -3.5dB)

Data

Level (dBm0)	Channel
-55	19.44
-53	20.4
-51	21.52
-49	23.55
-47	26.48
-45	27.71
-43	29.85
-41	32.78
-39	34.21
-37	35.95
-35	37.97
-33	40.44
-31	39.11
-29	40.05
-27	42.77
-25	40.25
-23	40.82
-21	43.03
-19	40.7
-17	41.41
-15	43.02
-13	40.98
-11	41.74
-9	42.64
-7	41.01
-5	41.95
-3	42.54
-1	40.94
1	42.19
3	42.06

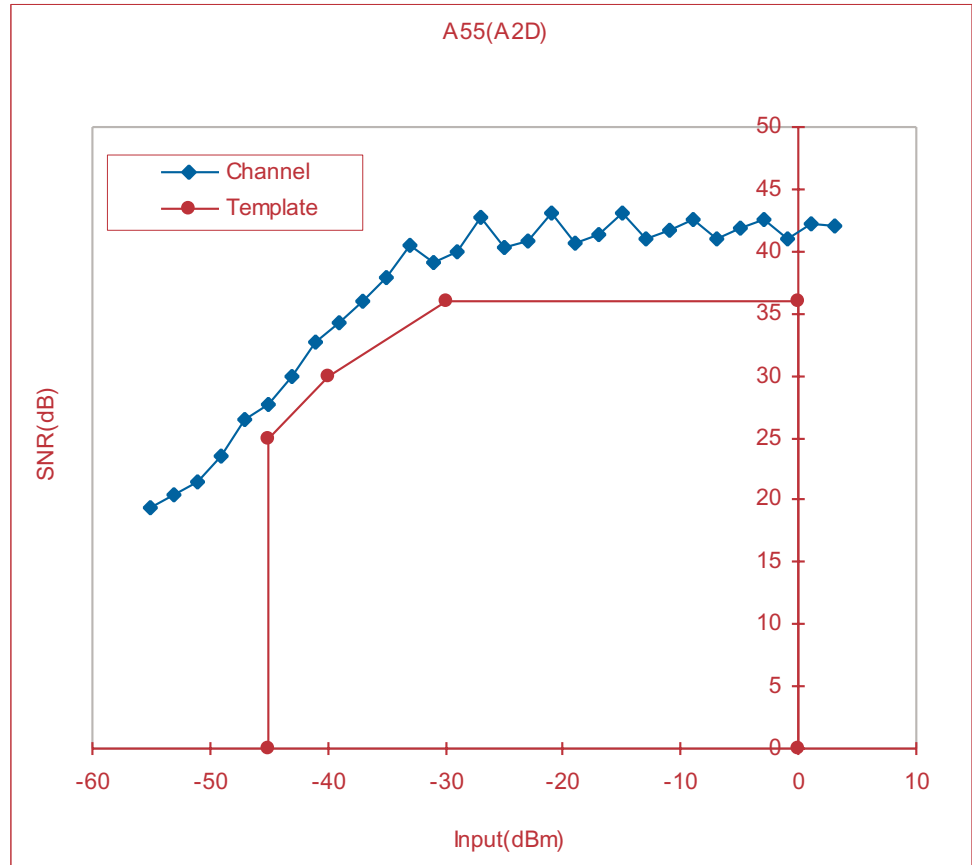

6429drw13

### Total Distortion - A55 (D2A)

(For 900Ω impedance, system target gain of A2D: 0dB; system target gain of D2A: -3.5dB)

Data

Level (dBm0)	Channel
-55	16.92
-53	18.65
-51	20.86
-49	22.92
-47	25.52
-45	27.73
-43	29.71
-41	32.65
-39	34.54
-37	36.05
-35	38.49
-33	40.68
-31	38.86
-29	40.91
-27	42.47
-25	39.34
-23	41.22
-21	43.19
-19	39.7
-17	40.93
-15	42.98
-13	40.34
-11	40.66
-9	43.5
-7	40.13
-5	40.59
-3	43.34
-1	40.47
1	40.99
3	43.24

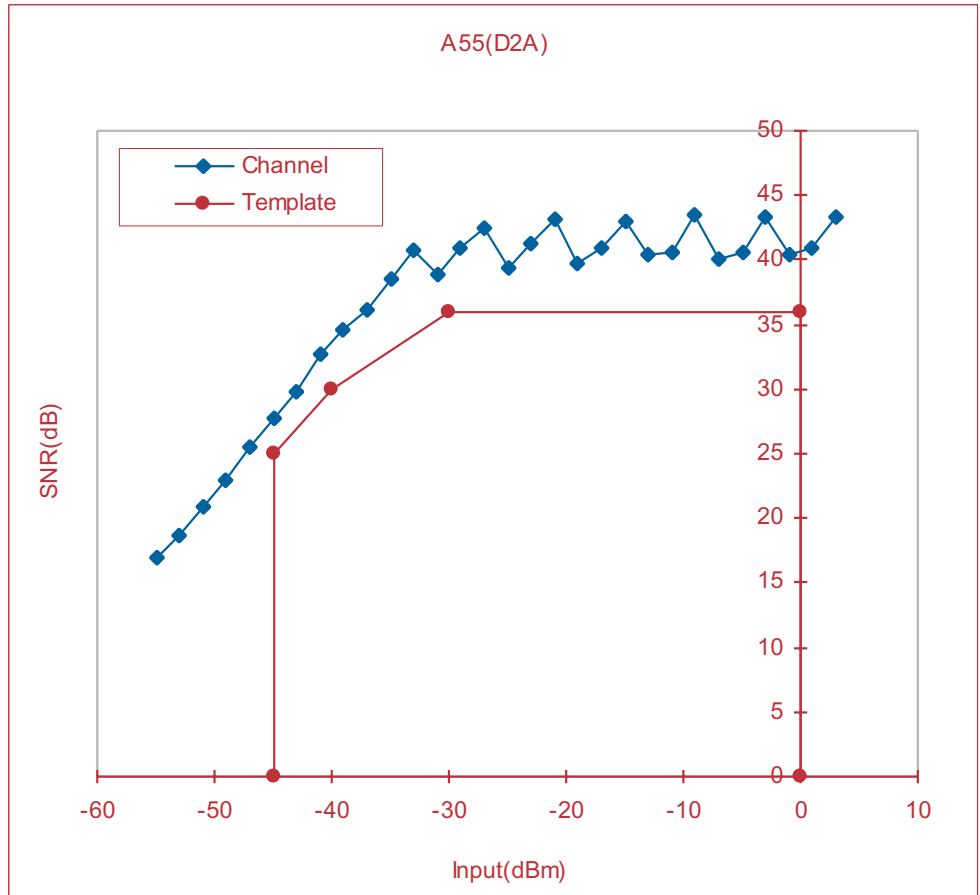

6429drw14

## COEFFICIENTS IN DSP RAM 900Ω

The system target gain from tip / ring to digital port: 0 dB

The system target gain from digital port to tip / ring: -7 dB

Coefficients in the DSP Ram From low address to high address:

IMF Ram:	0F	26	0F	EE	00	00	00	00	00	00	00	00	00	00	00	00
ECF Ram:	CE	F5	CC	11	00	00	00	00	00	00	80	53	F7	E0	00	00
GIS + Dual Tone Ram:	00	00	B8	A4	00	00	00	00	00	00	00	00	00	00	00	00
FRX + GTX Ram:	3E	FF	42	F2	04	1F	04	1F	42	F2	3E	FF	66	3E	57	06
FRR + GRX Ram:	CD	01	33	F3	0F	22	0F	22	33	F3	CD	01	CD	24	2D	14

1. Select filter coefficients in the Coe-RAM by setting LREG1 to FFH;
2. Set the analog gain of A/D to 6 dB by setting the GAD bit in LREG9 to "1";
3. Set the analog gain of D/A to -6 dB by setting the GDA bit in LREG9 to "1".

### Total Distortion - A55 (A2D)

(For 900Ω impedance, system target gain of A2D: 0dB; system target gain of D2A: -7dB)

Data

Level (dBm0)	Channel
-55	19.3
-53	20.74
-51	21.77
-49	23.57
-47	26.45
-45	27.96
-43	29.89
-41	32.95
-39	34.38
-37	36.22
-35	37.89
-33	40.61
-31	39.71
-29	40.57
-27	42.46
-25	40.71
-23	41.18
-21	42.77
-19	41.02
-17	41.8
-15	42.37
-13	40.94
-11	42
-9	42.36
-7	41.04
-5	42.22
-3	42.27
-1	41.36
1	42.28
3	42.32

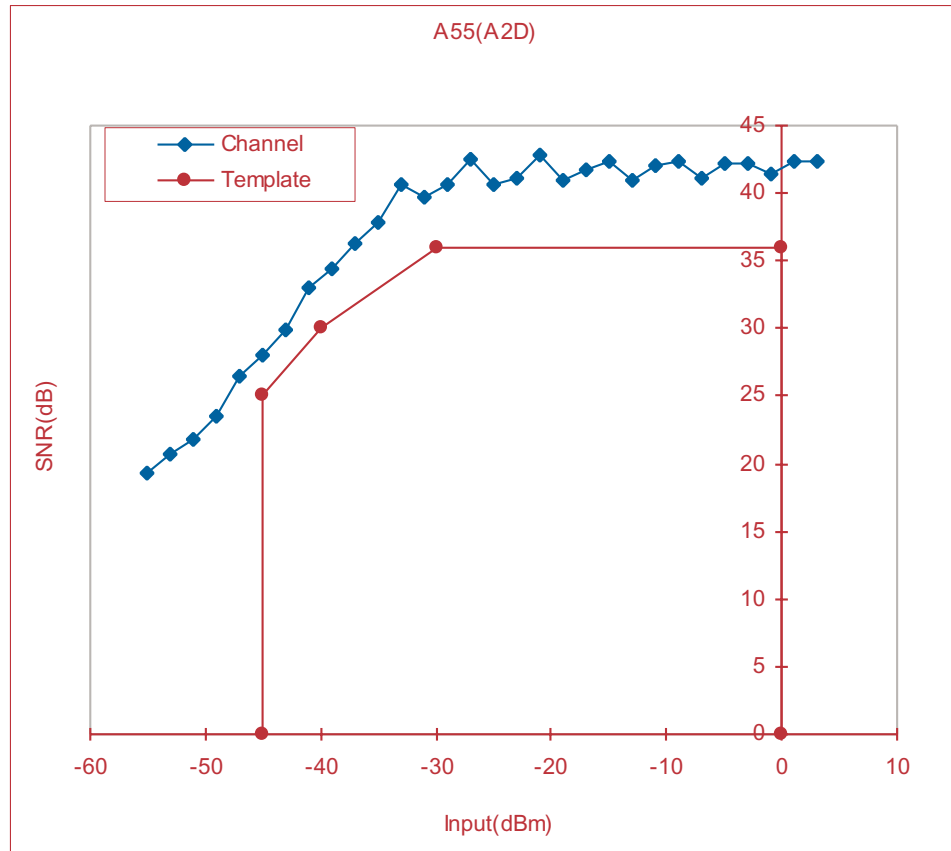

6429drw15



## Total Distortion - A55 (D2A)

(For 900Ω impedance, system target gain of A2D: 0dB; system target gain of D2A: -7dB)

### Data

Level (dBm0)	Channel
-55	16.51
-53	18.4
-51	19.66
-49	21.92
-47	24.36
-45	26.33
-43	28.59
-41	31.53
-39	33.11
-37	34.77
-35	37.05
-33	39.19
-31	38.24
-29	40.31
-27	41.79
-25	39.17
-23	41.01
-21	42.9
-19	39.65
-17	40.88
-15	42.92
-13	40.32
-11	40.65
-9	43.45
-7	40.14
-5	40.58
-3	43.34
-1	40.46
1	40.96
3	43.22

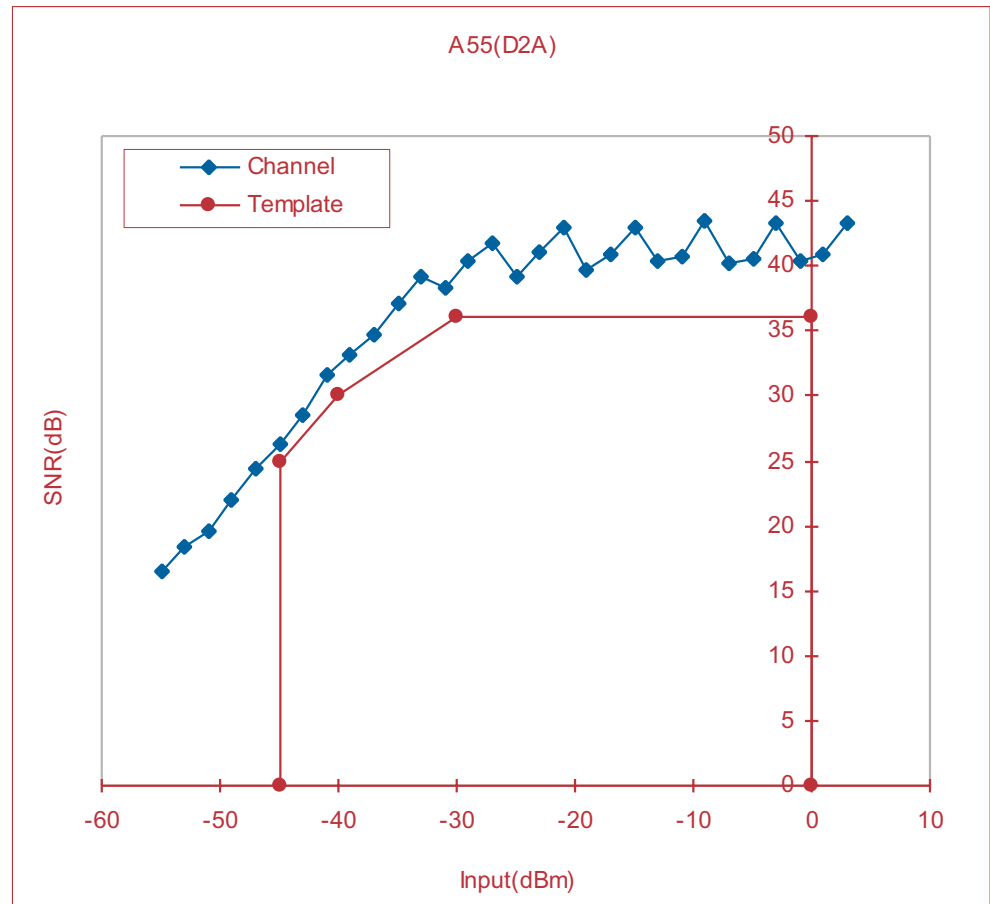

6429drw16

## COEFFICIENTS IN DSP RAM (200Ω & 680 || Ω 0.1μF)

The system target gain from tip / ring to digital port: 0 dB

The system target gain from digital port to tip / ring: 0 dB

Coefficients in the DSP Ram From low address to high address:

IMF Ram:	B8	DC	AF	0D	00	00	00	00	00	00	00	00	00	00	00	00
ECF Ram:	DC	F6	94	10	00	00	00	00	00	00	3A	5B	BC	DF	00	00
GIS + Dual Tone Ram:	00	00	F4	07	00	00	00	00	00	00	00	00	00	00	00	00
FRX + GTX Ram:	51	01	9D	ED	57	27	57	27	9D	ED	51	01	99	31	F4	05
FRR + GRX Ram:	3C	05	19	D7	36	35	36	35	19	D7	3C	05	99	31	85	15

1. Select filter coefficients in the Coe-RAM by setting LREG1 to FFH;
2. Set the analog gain of A/D to 6 dB by setting the GAD bit in LREG9 to "1"
3. Set the analog gain of D/A to 0 dB by setting the GDA bit in LREG9 to "0".

## Total Distortion - A55 (A2D)

(For China complex impedance, system target: gain of A2D is 0dB; gain of D2A is 0dB)

### Data

Level (dBm0)	Channel
-55	19.44
-53	20.83
-51	21.63
-49	23.69
-47	26.88
-45	27.93
-43	30.13
-41	32.72
-39	34.36
-37	36.14
-35	38.63
-33	39.94
-31	38.77
-29	40.85
-27	42.52
-25	39.67
-23	40.93
-21	43.05
-19	40.26
-17	40.66
-15	43.42
-13	40.37
-11	40.61
-9	43.48
-7	40.52
-5	40.97
-3	43.19
-1	40.71
1	41.32
3	42.98

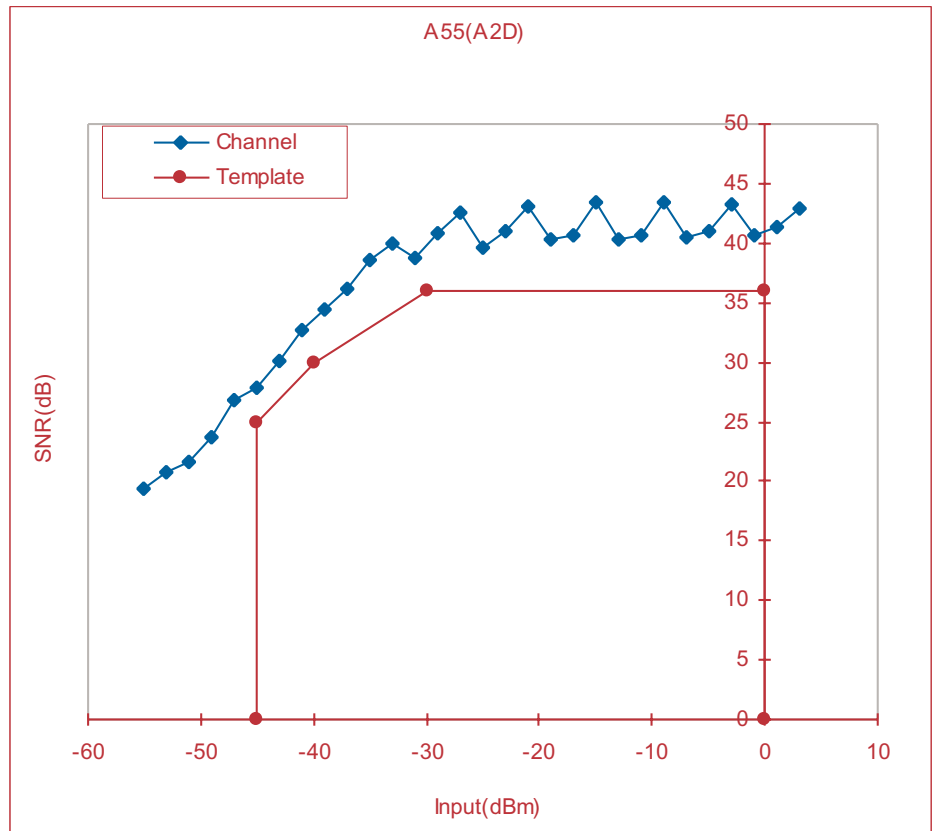

6429drw17

### Total Distortion - A55 (D2A)

(For China complex impedance, system target: gain of A2D is 0dB; gain of D2A is 0dB)

Data

Level (dBm0)	Channel
-55	18.3
-53	20.02
-51	21.38
-49	23.48
-47	26.23
-45	28.04
-43	29.93
-41	33.32
-39	34.82
-37	36.48
-35	38.73
-33	41.03
-31	38.99
-29	41.14
-27	42.55
-25	39.3
-23	41.18
-21	43.14
-19	39.67
-17	40.86
-15	42.93
-13	40.27
-11	40.61
-9	43.42
-7	40.08
-5	40.51
-3	43.28
-1	40.4
1	40.89
3	43.15

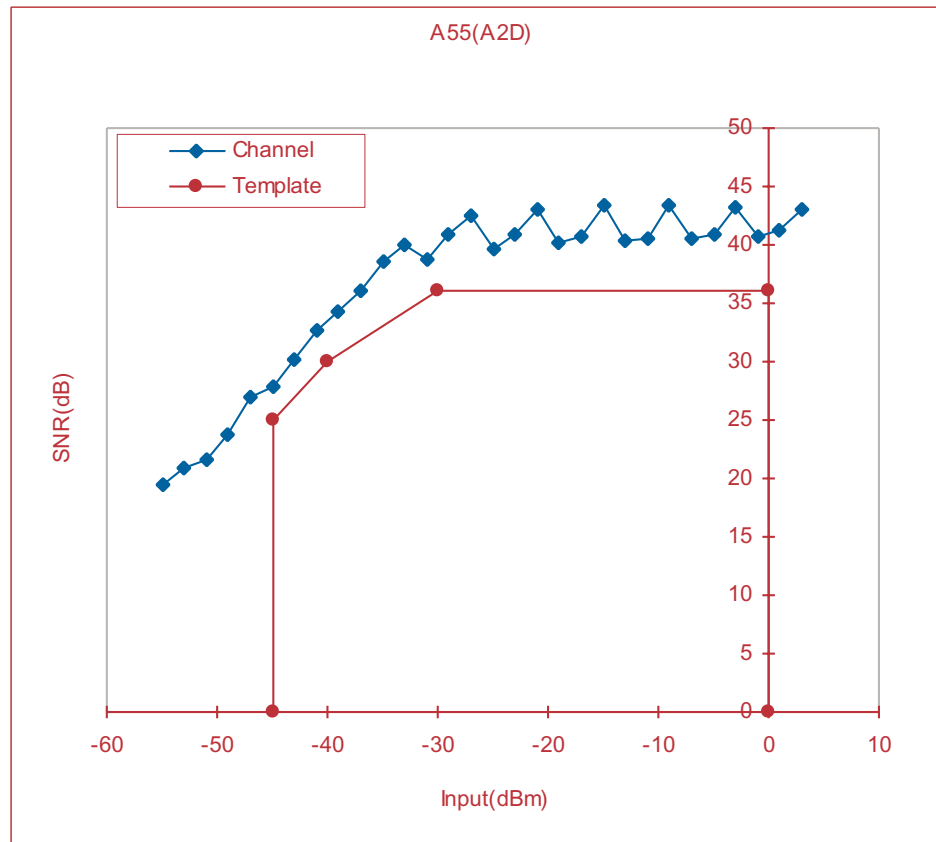

6429dvw18

## COEFFICIENTS IN DSP RAM (200Ω & 680Ω || 0.1μF)

The system target gain from tip / ring to digital port: 0 dB

The system target gain from digital port to tip / ring: -3.5 dB

Coefficients in the DSP Ram From low address to high address:

IMF Ram:	B8	DC	AF	0D	00	00	00	00	00	00	00	00	00	00	00	00
ECF Ram:	DC	F6	94	10	00	00	00	00	00	00	3A	5B	BC	DF	00	00
GIS + Dual Tone Ram:	00	00	F4	07	00	00	00	00	00	00	00	00	00	00	00	00
FRX + GTX Ram:	51	01	9D	ED	57	24	57	24	9D	ED	51	01	99	31	F4	05
FRR + GRX Ram:	3C	05	19	D7	36	35	36	35	19	D7	3C	05	99	31	62	0E

1. Select filter coefficients in the Coe-RAM by setting LREG1 to FFH;
2. Set the analog gain of A/D to 6 dB by setting the GAD bit in LREG9 to "1";
3. Set the analog gain of D/A to 0 dB by setting the GDA bit in LREG9 to "0".

### Total Distortion - A55 (A2D)

(For China complex impedance, system target: gain of A2D is 0dB; gain of D2A is -3.5dB)

Data

Level (dBm0)	Channel
-55	19.44
-53	20.83
-51	21.63
-49	23.69
-47	26.88
-45	27.93
-43	30.13
-41	32.72
-39	34.36
-37	36.14
-35	38.63
-33	39.94
-31	38.77
-29	40.85
-27	42.52
-25	39.67
-23	40.93
-21	43.05
-19	40.26
-17	40.66
-15	43.42
-13	40.37
-11	40.61
-9	43.78
-7	40.52
-5	40.97
-3	43.19
-1	40.71
1	41.32
3	42.98

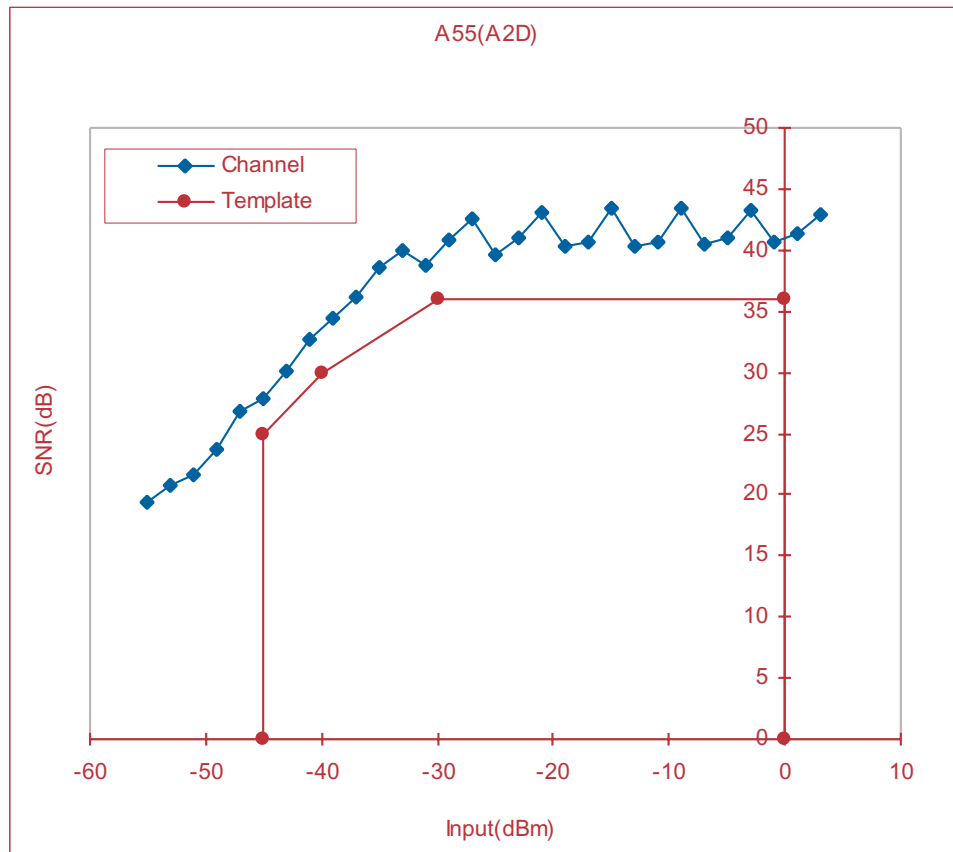

6429drw19

## Total Distortion - A55 (D2A)

(For China complex impedance, system target: gain of A2D is 0dB; gain of D2A is -3.5dB)

### Data

Level (dBm0)	Channel
-55	17.35
-53	19.57
-51	20.85
-49	23.05
-47	25.74
-45	27.62
-43	29.37
-41	32.7
-39	34.2
-37	35.93
-35	38.21
-33	40.41
-31	38.73
-29	40.81
-27	42.39
-25	39.2
-23	41.11
-21	43.07
-19	39.64
-17	40.85
-15	42.92
-13	40.26
-11	40.6
-9	43.42
-7	40.08
-5	40.51
-3	43.28
-1	40.4
1	40.89
3	43.16

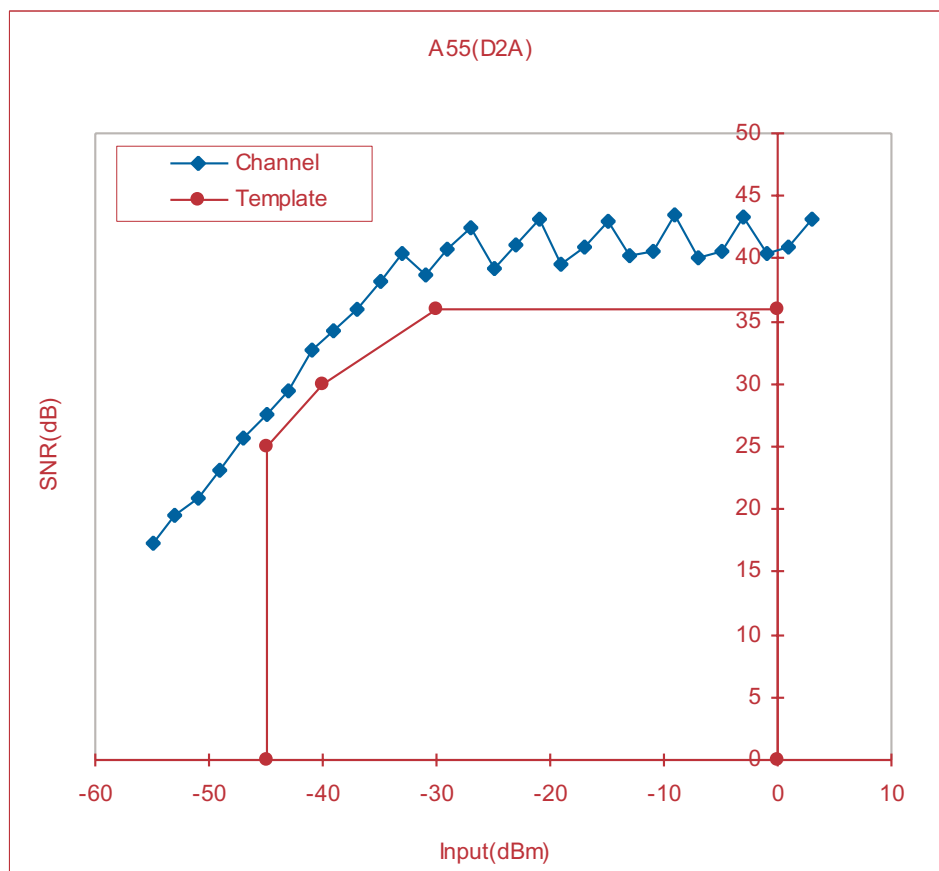

6429drw20

## COEFFICIENTS IN DSP RAM (200Ω & 680Ω || 0.1μF)

The system target gain from tip / ring to digital port: 0 dB

The system target gain from digital port to tip / ring: -7 dB

Coefficients in the DSP Ram From low address to high address:

IMF Ram:	B8	DC	AF	0D	00	00	00	00	00	00	00	00	00	00	00	00
ECF Ram:	DC	F6	94	10	00	00	00	00	00	00	3A	5B	BC	DF	00	00
GIS + Dual Tone Ram:	00	00	F4	07	00	00	00	00	00	00	00	00	00	00	00	00
FRX + GTX Ram:	51	01	9D	ED	57	24	57	24	9D	ED	51	01	99	31	F4	05
FRR + GRX Ram:	3C	05	19	D7	36	35	36	35	19	D7	3C	05	99	31	97	09

1. Select filter coefficients in the Coe-RAM by setting LREG1 to FFH;
2. Set the analog gain of A/D to 6 dB by setting the GAD bit in LREG9 to "1";
3. Set the analog gain of D/A to 0 dB by setting the GDA bit in LREG9 to "0".



### Total Distortion - A55 (A2D)

(For China complex impedance, system target: gain of A2D is 0dB; gain of D2A is -7dB)

Data

Level (dBm0)	Channel
-55	19.44
-53	20.83
-51	21.63
-49	23.69
-47	26.88
-45	27.93
-43	30.13
-41	32.72
-39	34.36
-37	36.14
-35	38.63
-33	39.94
-31	38.77
-29	40.85
-27	42.52
-25	39.67
-23	40.93
-21	43.05
-19	40.26
-17	40.66
-15	43.42
-13	40.37
-11	40.61
-9	43.48
-7	40.52
-5	40.97
-3	43.19
-1	40.71
1	41.32
3	42.98

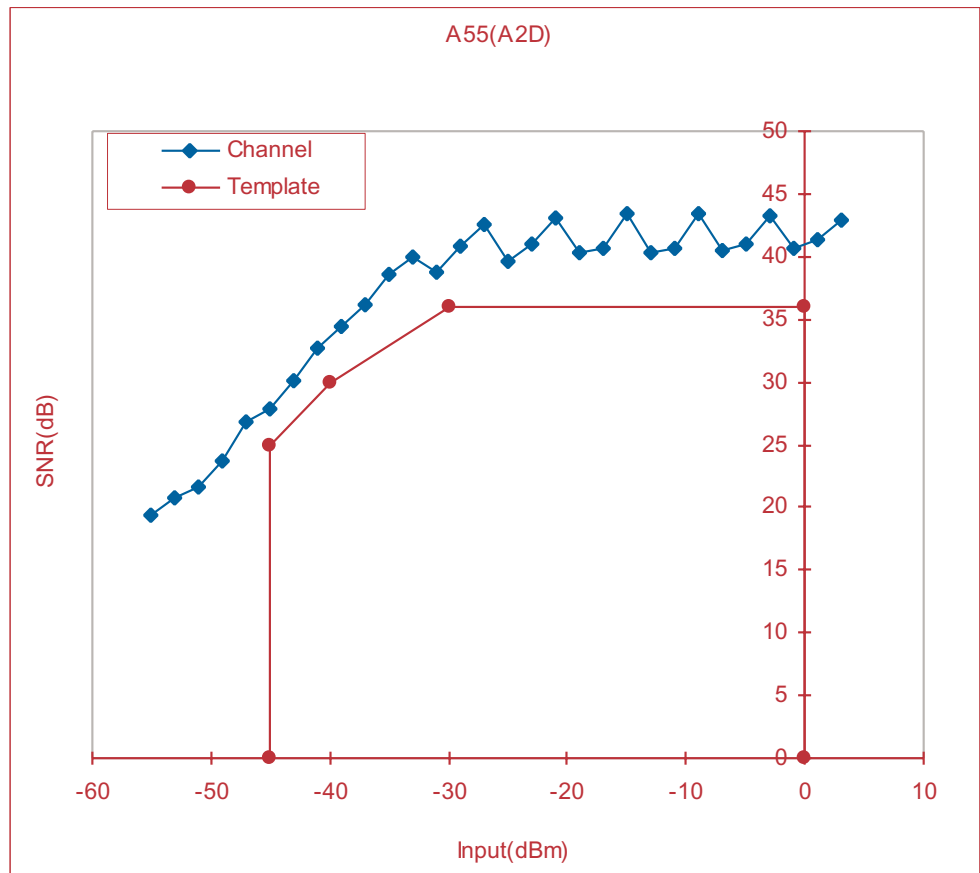

6429drw21

### Total Distortion - A55 (D2A)

(For China complex impedance, system target: gain of A2D is 0dB; gain of D2A is -7dB)

Data

Level (dBm0)	Channel
-55	16.14
-53	18.21
-51	19.61
-49	22.09
-47	24.79
-45	26.56
-43	28.68
-41	31.55
-39	33.26
-37	34.86
-35	37.12
-33	39.53
-31	38.31
-29	40.33
-27	41.85
-25	39.07
-23	40.92
-21	42.9
-19	39.64
-17	40.8
-15	42.86
-13	40.25
-11	40.59
-9	43.39
-7	40.07
-5	40.52
-3	43.27
-1	40.39
1	40.89
3	43.16

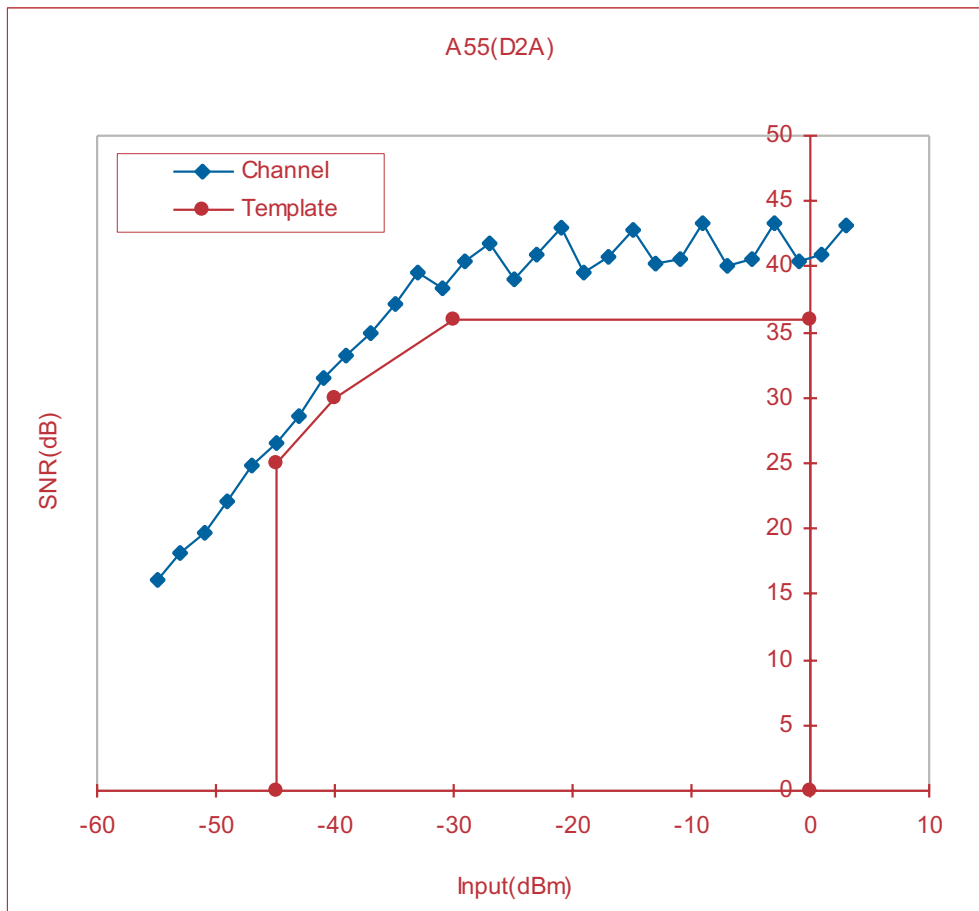

6429dnw22

  
**Document History**

9/27/2004 pgs. 8, 11, 14, 17, 20, 26, 29, 32

## IMPORTANT NOTICE AND DISCLAIMER

RENESAS ELECTRONICS CORPORATION AND ITS SUBSIDIARIES (“RENESAS”) PROVIDES TECHNICAL SPECIFICATIONS AND RELIABILITY DATA (INCLUDING DATASHEETS), DESIGN RESOURCES (INCLUDING REFERENCE DESIGNS), APPLICATION OR OTHER DESIGN ADVICE, WEB TOOLS, SAFETY INFORMATION, AND OTHER RESOURCES “AS IS” AND WITH ALL FAULTS, AND DISCLAIMS ALL WARRANTIES, EXPRESS OR IMPLIED, INCLUDING, WITHOUT LIMITATION, ANY IMPLIED WARRANTIES OF MERCHANTABILITY, FITNESS FOR A PARTICULAR PURPOSE, OR NON-INFRINGEMENT OF THIRD PARTY INTELLECTUAL PROPERTY RIGHTS.

These resources are intended for developers skilled in the art designing with Renesas products. You are solely responsible for (1) selecting the appropriate products for your application, (2) designing, validating, and testing your application, and (3) ensuring your application meets applicable standards, and any other safety, security, or other requirements. These resources are subject to change without notice. Renesas grants you permission to use these resources only for development of an application that uses Renesas products. Other reproduction or use of these resources is strictly prohibited. No license is granted to any other Renesas intellectual property or to any third party intellectual property. Renesas disclaims responsibility for, and you will fully indemnify Renesas and its representatives against, any claims, damages, costs, losses, or liabilities arising out of your use of these resources. Renesas' products are provided only subject to Renesas' Terms and Conditions of Sale or other applicable terms agreed to in writing. No use of any Renesas resources expands or otherwise alters any applicable warranties or warranty disclaimers for these products.

(Rev.1.0 Mar 2020)

### Corporate Headquarters

TOYOSU FORESIA, 3-2-24 Toyosu,  
Koto-ku, Tokyo 135-0061, Japan  
[www.renesas.com](http://www.renesas.com)

### Contact Information

For further information on a product, technology, the most up-to-date version of a document, or your nearest sales office, please visit:  
[www.renesas.com/contact/](http://www.renesas.com/contact/)

### Trademarks

Renesas and the Renesas logo are trademarks of Renesas Electronics Corporation. All trademarks and registered trademarks are the property of their respective owners.