White Paper

Powering IoT Infrastructure Systems with Digital Multiphase

Introduction

The explosive growth of cloud services has driven major advancements in data center, networking and telecom equipment. The next wave underway is the Internet of Things (IoT) with its billions of devices connected to the cloud. All of this growth greatly impacts the servers, storage, and networking switches that process an ever-increasing amount of data and video. It's pushing infrastructure equipment to the limit in terms of processing power and bandwidth. For power designers, the main challenge is how to efficiently power and cool this equipment, while ensuring minimal electricity usage. Designers also must balance board power footprints with thermals when using today's advanced processors, ASICs and FPGAs.

This white paper examines the evolution of the multiphase converter architecture from analog to digital implementations, and compares the various control mode schemes. We will look at a new class of multiphase controllers that leverage digital control techniques to provide synthetic current control. This evolution in control technology allows the power solution to provide cycle-by-cycle current balancing and faster transient response, while tracking each phase current with zero latency.

The Multiphase Evolution

With the increasing functionality of end systems, greater capabilities and IoT interconnectivity, there is a corresponding increase in processing power to address these requirements. This processing capability is centralized in data centers where high end CPUs, digital ASICs, and network processors run servers, storage, and networking equipment. And they are distributed across the network through telecom equipment, and occurring at the point of transaction with point of sales machines, desktops or embedded computing systems using CPUs or FPGAs.

What all of these devices have in common is that their digital processing needs have a similar power profile. With shrinking processor geometries and increased transistor count, processors are now requiring higher output currents that can range anywhere from 100A to 400A or more, depending on their complexity. While this trend has persisted for years, the industry has been able to adapt by integrating lower power states into the digital loads. This allows them to idle at lower currents, and then peak to full power when demanded. While beneficial to the overall system power budget, it adds another challenge to the power designer. The full load current in excess of 200A still needs to be delivered and thermally managed, but now the supply has to react to the demand of a large load step of over 100A in less than a microsecond while keeping the output in a narrow regulation window.

In end systems, the common solution has been to use a multiphase DC/DC buck converter to provide the required power conversion, typically ~1V output from a 12V input. To provide the large load currents, it's easier to design a multiphase solution splitting the load across smaller stages (called phases) rather than trying to deliver it via one stage. Attempting to handle too much current in one phase presents challenges in designing the magnetics and FETs, as well as managing thermals, from a $(I^2) \cdot R$ perspective. A multiphase solution offers high efficiency, smaller size and lower cost than a single stage for high currents. This approach is analogous to the technology direction taken by the end loads where multicore CPUs divide the workload. Figure 1 illustrates a multiphase solution that utilizes four phases to provide 150A to the CPU.

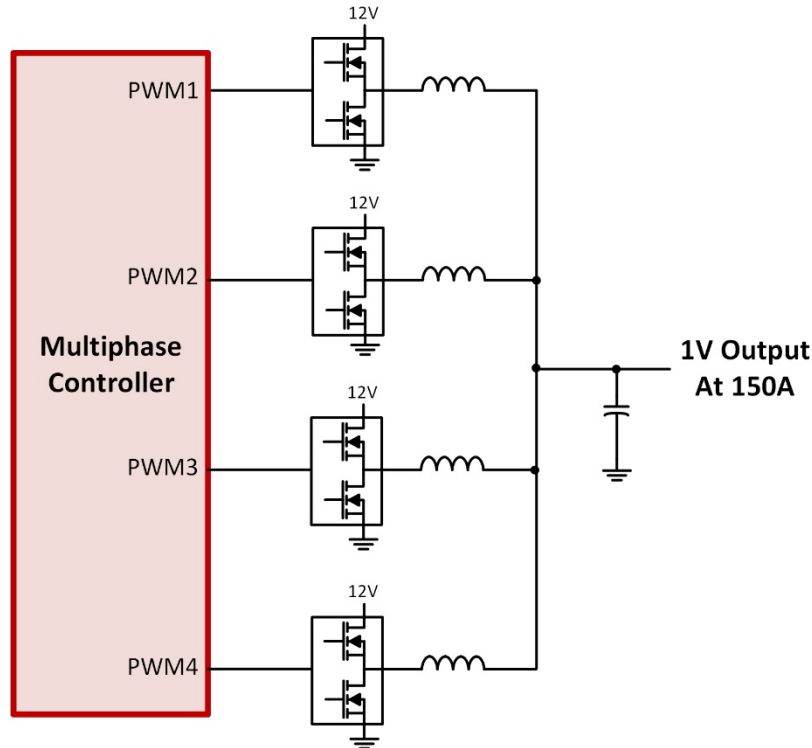

Figure 1. Multiphase solution using four phases

Voltage Control Schemes

While multiphase solutions provide the best power architecture, the implementation needs to be carefully evaluated to match up with the latest generation of processors. The trend with end systems has always been enhanced features, smaller size, and improved power management. This is reflected in power designs increasing their switching frequencies to minimize size and manage lower output voltages with higher current in full load and transient conditions. These trends have presented problems in how power supplies are regulated, requiring control loops to evolve over time to keep pace. The key challenge in a multiphase controller is managing the current in each phase, which requires considering these key points:

- Each phase current must equally share the load. If N number of phases exist, the current for each phase should be $I_{\text{phase}} = I_{\text{out}} / N$ at all times.
- Phase currents must be balanced during steady state and transients.

It is important to maintain these conditions; otherwise, you'll be stuck overdesigning your power supply. For instance, imbalance of phase currents during steady state would result in a thermal imbalance. While in a transient condition, if only one phase reacted to a load step, its inductor would have to be significantly oversized, defeating the original purpose of multiphase.

To meet the two conditions noted above, it's important that the control loop have full knowledge of phase currents and the output voltage at all times, without latency or delay in sampling. Historically, this was achieved by using analog current mode control schemes that maintain phase balance cycle-by-cycle. This approach, however, disappeared in the market years ago as output voltages dropped and frequencies increased presenting a challenge in obtaining an accurate signal. For instance, in a modern system implementation from 12V to 1V with a switching frequency of 500kHz, the high side on-time will be

approximately 166ns. This is a short period to get an accurate reading, while battling the significant ringing and noise due to the discontinuity of input current.

As a result, the market moved towards analog voltage based control schemes including Constant On Time (COT) or traditional voltage mode with type 3 compensation. This was done in an effort to obtain a fast transient response, and minimize the output capacitance needed to manage large transients while avoiding the signal integrity issues in current sensing. The downside with voltage loops is that you lose the phase current information that is critical for phase balancing and current positioning, either from keeping inductor size down or for positioning with load lines—large digital processors typically implement a load line where the output voltage is moved in relation to the output load. Figure 2 illustrates the problem by showing the current response to a load transient.

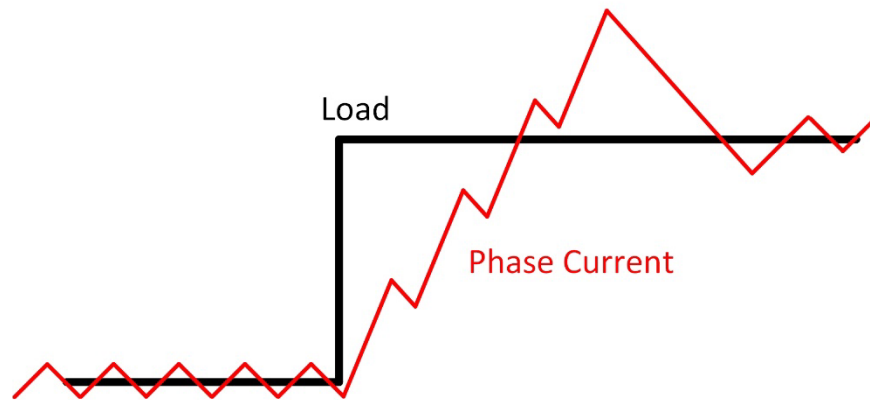

Figure 2. Phase current reaction with load transient

Figure 2 demonstrates that as voltage loops extend bandwidth to achieve a fast response, we get an underdamped current response. This is reflected in the phase currents overshooting the desired load targets (during the transients) in attempt to get the voltage back to its regulation point. While a high peak could be acceptable, it results in oversized inductors and the problem is magnified when current balancing is examined under high load transients.

Today's newer digital ASICs actively manage their power footprint by continuously scaling their power requirements. This is done by turning on and off sections of the ASIC as needed by their processing demands. Instead of a constant full load current, their power needs continuously change based on operating conditions. This poses a unique challenge for the power supply. Figure 3 illustrates a common situation with a 6-phase power solution that has to respond to a continuous load transient slewing exactly at the power supply switching frequency and high slew rates.

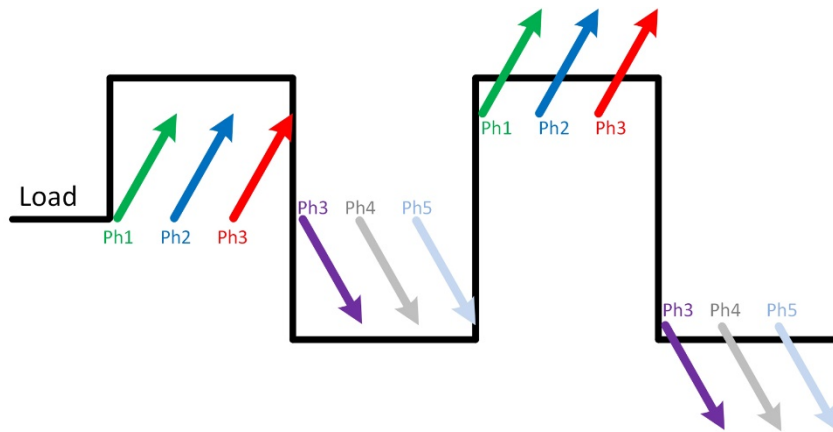

Figure 3. Idealized waveform showing phases responding to transient

As shown in Figure 3, the initial load step causes the first three phases to respond. Note that multiphase solutions have phases interleaved to reduce output ripple. When it's time for the fourth phase to turn on, the load current has decreased with a resultant change in V_{out} . This causes the remaining three phases to decrease, attempting to respond to the load change. By the end of the cycle, the steady state current remains the same and is delivered by the average of the phase currents. But, as the load transient continues to repeat, the phases diverge further, even though meeting the average current need. This is the inherent issue with multiphase balancing because stable operating points can be reached several ways. A 2-phase solution with a 20A output can be met by the two phases combining in the manner of 15A+5A, or 20A+0A, or even 100A+(-80A). Of course, the ideal case would be the two phases equally sharing at 10A+10A.

Current control schemes do not have this imbalance as they are naturally controlling the current in each phase to the same level, forcing convergence under any transient condition. Voltage mode, however, lacks the phase current information that could lead to runaway conditions unless carefully managed. The only solution to remedy the imbalance is to add a current loop that forces phases to converge to the average current. A typical analog implementation in voltage mode controllers is shown in Figure 4, where each phase current is filtered and summed. This allows the loop to force convergence to the running average.

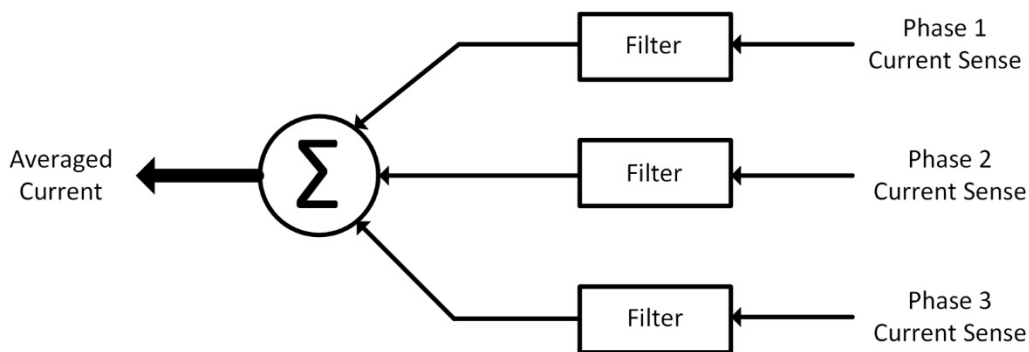

Figure 4. Slow current loop in voltage control loops

The downside is that this introduces a slower loop in the system, taking multiple cycles to enact, which affects the controller's ability to respond. The industry has used this approach for several years as control schemes have not been able to overcome the noise and sensing challenges required to get accurate and full

bandwidth current information into the loop. This challenge has opened the path for innovation using digital control methodologies to overcome the current sensing.

A Breakthrough with Synthetic Current Control

A new approach was to directly solve the problem of current sensing, as opposed to avoiding the issue using workarounds in voltage control. Intersil's breakthrough was made possible by utilizing state of the art, digital control technology. Advanced control methodologies could be applied by moving the entire control, monitoring and compensation into the digital domain. The result is a synthetic current control loop that provides cycle-by-cycle phase current balancing with fast transient response.

The genesis of the new control scheme was the realization that while the high side current signal is critical in the loop, it is not possible to measure directly due to the short on-time and high noise environment. Instead, the Intersil controller uses a synthetic current signal that is artificially generated, giving it the benefit of being noise-free and accurate and with zero latency. The basic principle is that all the parameters involved in determining the phase current can be measured directly each cycle, allowing the controller to derive the current, as shown in the Figure 5 current waveform.

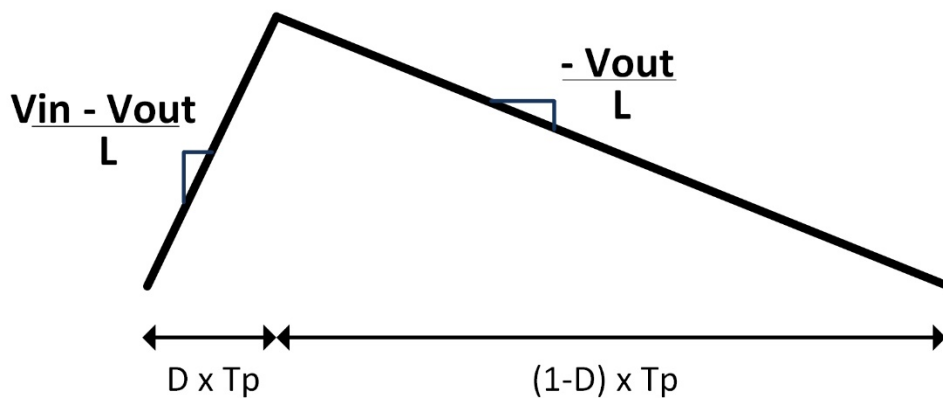

Figure 5. Inductor current waveform

The slope of the current waveform is related to the input/output voltage and the inductance. By continuously measuring the voltages and calculating the inductance, a synthetic current waveform can be generated. Calibrating via real measurements on the current downslope allows the controller to eliminate any error because of current offset or slope. This allows the controller to compensate for any changes in the system as a result of aging, thermal or inductor saturation. In addition to the internal noise-free current waveform, the controller can be positioned to account for loop latency. Since the inductor current ramps are timed to the PWM, whose signal is sent from the controller, the digital loop can account for all the propagation delays through the Intersil smart power stages, thereby eliminating latency in the internal current waveforms.

This capability is just one of the benefits that can be leveraged by having the entire loop control in the digital domain with current and voltage information. The Figure 6 block diagram shows that digital signal processing can be applied in various areas to improve overall response. The voltage loop compensation is applied using conventional PID coefficients, which can be adjusted real-time via the Intersil PowerNavigator™ GUI. In situations with very stringent voltage windows, transient performance can be further aided by using AC current feedback. Adjustable filters and thresholds are implemented to inject dynamic load changes directly into the loop, providing a quicker response proportional to the load step.

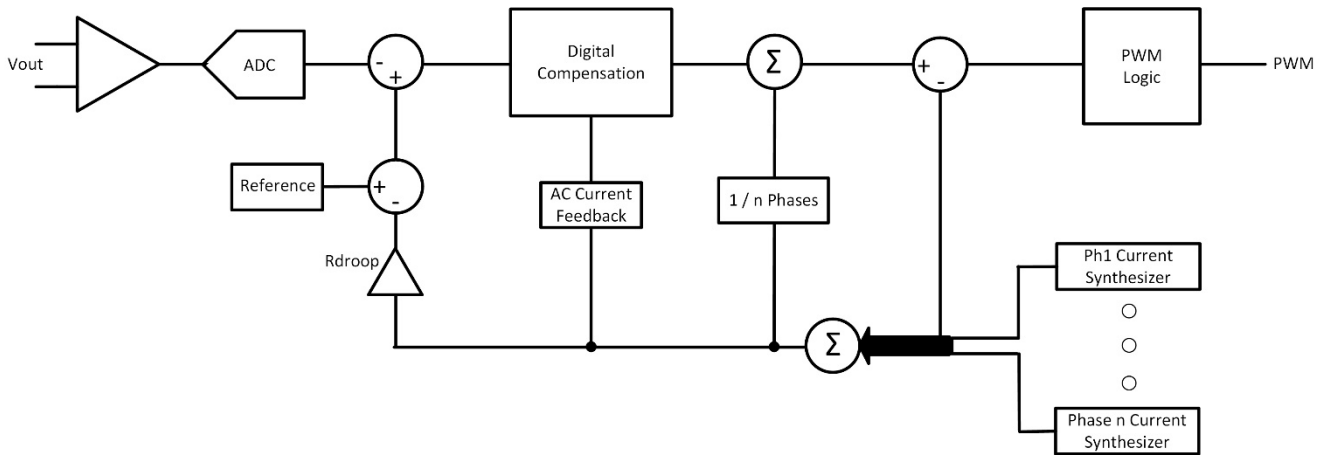

Figure 6. Block diagram of control loop

The Synthetic Control Advantage

The benefits of synthetic current control are that a multiphase power supply can now be designed with cycle-by-cycle current balancing and fast transient response. The current in each phase is known precisely, allowing the device to maintain stable operation under continuous load transients, where all phases equally share current. Combined with zero latency in current feedback path, synthetic control enables the device to respond faster to load conditions, minimizing output capacitance. Even with high current CPUs, it is possible to utilize an “all ceramic” output capacitor solution. With zero latency, full bandwidth, digital current waveforms, the control loop can position the output voltage exactly according to the load line, mimicking the exact response of the load profile. This avoids the traditional analog RC decay that is seen in output voltages as they settle to the new target voltage. Figure 7 shows that in situations where a load line is not required, the device is still able to meet any load transient, while keeping the device in regulation.

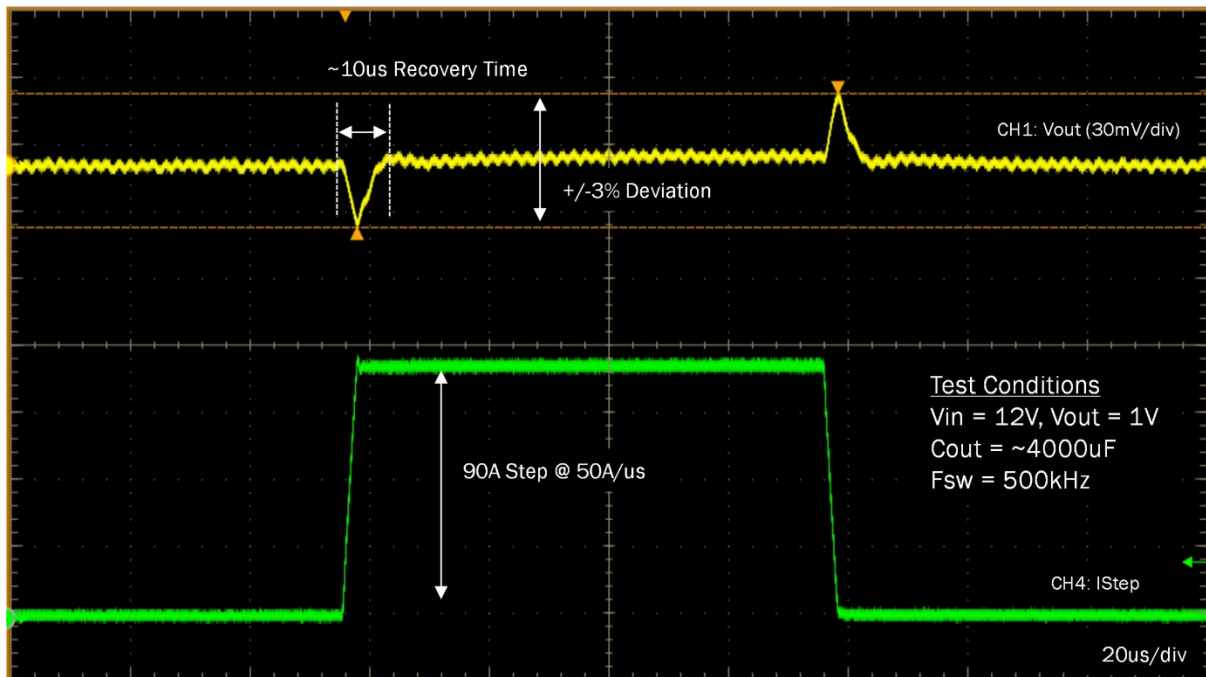

Figure 7. Transient response of 90A load step

As shown, a synthetic current control loop allows multiphase controllers to power any modern high current loads, whether it's a CPU, FPGA or ASIC. The accurate control and positioning of the phase currents allow the controller to meet any transient with minimal output capacitance without oversizing the inductors.

Conclusion

The multiphase control architecture has evolved into the digital domain, enabling a greater capability in solving the challenges of powering modern high current loads. This benefit, while demonstrable with the revolutionary synthetic current control in its transient response and phase balancing, lends itself to many other aspects of power supply design that have not been discussed. One aspect not to be overlooked is the ability to adjust, control and monitor every setting via software. From a high level, this provides a simpler approach for designing and tuning loops as software interfaces such as the PowerNavigator GUI can be used to setup an entire design in minutes. But the board level impact becomes apparent when having to debug systems. The ability to instantly understand the status and condition of the power supply, along with compensating for noisy conditions through adjustable filters and real time software control provides the peace of mind that any challenge can be met without re-design of boards. These intangible benefits will result in digital control being used for an increasing number of power supplies.

Next Steps

- [Learn more about the digital multiphase controllers](#)
- [Download the datasheets](#)
- [Watch an overview video](#)
- [Find out more about the PowerNavigator GUI](#)

About Renesas Electronics Corporation

Renesas Electronics Corporation delivers trusted embedded design innovation with complete semiconductor solutions that enable billions of connected, intelligent devices to enhance the way people work and live—securely and safely. A global leader in microcontrollers, analog, power, and SoC products, Renesas provides the expertise, quality, and comprehensive solutions for a broad range of Automotive, Industrial, Home Electronics, Office Automation and Information Communication Technology applications to help shape a limitless future. Learn more at [renesas.com](https://www.renesas.com)

+1 408-432-8888 | © Renesas Electronics America. All rights reserved. Renesas (and design) are trademarks owned by Renesas Electronics Corporation or one of its subsidiaries. All other trademarks mentioned are the property of their respective owners.