



## **Total dose testing of the ISL70001SRH hardened point of load regulator**

**Nick van Vonno  
Intersil Corporation**

Revision 3  
16 August 2011

### **Table of Contents**

- 1. Introduction**
- 2. Reference Documents**
- 3. Part Description**
- 4. Test Description**
  - 4.1 Irradiation facility**
  - 4.2 Test fixturing**
  - 4.3 Characterization equipment and procedures**
  - 4.4 Experimental Matrix**
  - 4.5 Downpoints**
- 5 Results**
  - 5.1 Test results**
  - 5.2 Variables data**
- 6 Conclusion**
- 7 Appendices**
- 8 Document revision history**

## 1. Introduction

This report provides results of a low and high dose rate total dose test of the ISL70001SRH point of load converter. The test was conducted in order to determine the sensitivity of the part to the total dose environment and to determine if the part is low dose rate sensitive.

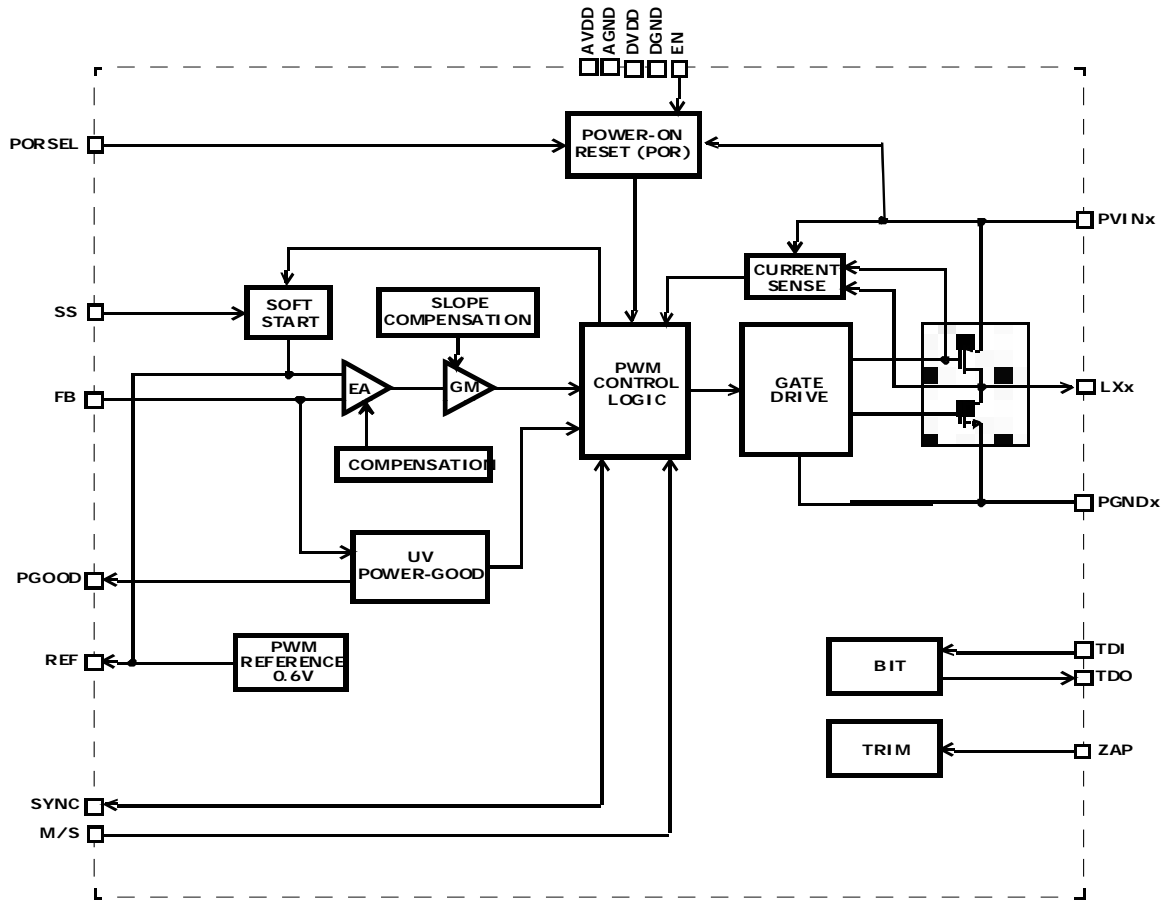
Intersil markets two versions of the ISL70001SRH. The base ISL70001SRH is acceptance tested on a wafer by wafer basis to 100 krad(Si) at high dose rate, as defined in MIL-STD-883 test method 1019 (50 – 300 rad(Si)/s). The ISL70001SEH is acceptance tested on a wafer by wafer basis to 100 krad(Si) at high dose rate, as defined in MIL-STD-883 test method 1019 (50 – 300 rad(Si)/s), and to 50 krad(Si) at low dose rate, also as defined in method 1019 (0.01 rad(Si)/s maximum). The ISL70001SRH and ISL70001SEH are identical parts.

## 2. Reference Documents

MIL-STD-883G test method 1019.7  
ISL70001SRH data sheet  
DSCC Standard Microcircuit Drawing (SMD) 5962-09225

## 3: Part Description

The ISL70001SRH is a high efficiency monolithic synchronous buck regulator with integrated power MOSFET devices, eliminating the need for external MOSFET devices. The part is designed for point of load (POL) applications and provides a single chip power management solution for digital ICs such as processors and field programmable gate arrays. The ISL70001SRH is designed and rated for the total dose and SEE environments as encountered in space and is manufactured in compliance with MIL-PRF-38535. The part operates over an input voltage range of 3V to 5.5V and provides a regulated output voltage that is externally adjustable from 0.8V to ~85% of the input voltage. Output load current capacity is 6A for  $T_J < +145^{\circ}\text{C}$ . The ISL70001SRH utilizes peak current-mode control with integrated compensation and switches at a fixed frequency of 1MHz. The high level of integration provided by integrating the power MOSFET devices makes the ISL70001SRH a good choice to power small form factor applications in space systems. A simplified block diagram of the part is shown in Figure 1.



**Figure 1:** ISL70001SRH block diagram.

The ISL70001SRH is implemented in a submicron BiCMOS process optimized for power management applications, with 0.6um minimum ground rules and three layers of interconnect. The process features salicided source/drain regions for low contact resistance, which is a necessity for integrated power MOSFET applications. Active devices include low voltage CMOS and high voltage DMOS devices as well as complementary bipolars. The process is in volume production under MIL-PRF-38535 certification and is used for a wide range of commercial power management devices. In order to retain the advantages of volume production, the ISL70001SRH was designed for total dose and SEE hardness using well-known ‘hardened by design’ techniques, including closed geometry N-channel devices, guard rings and latchup-prevention layout design.

## 4: Test Description

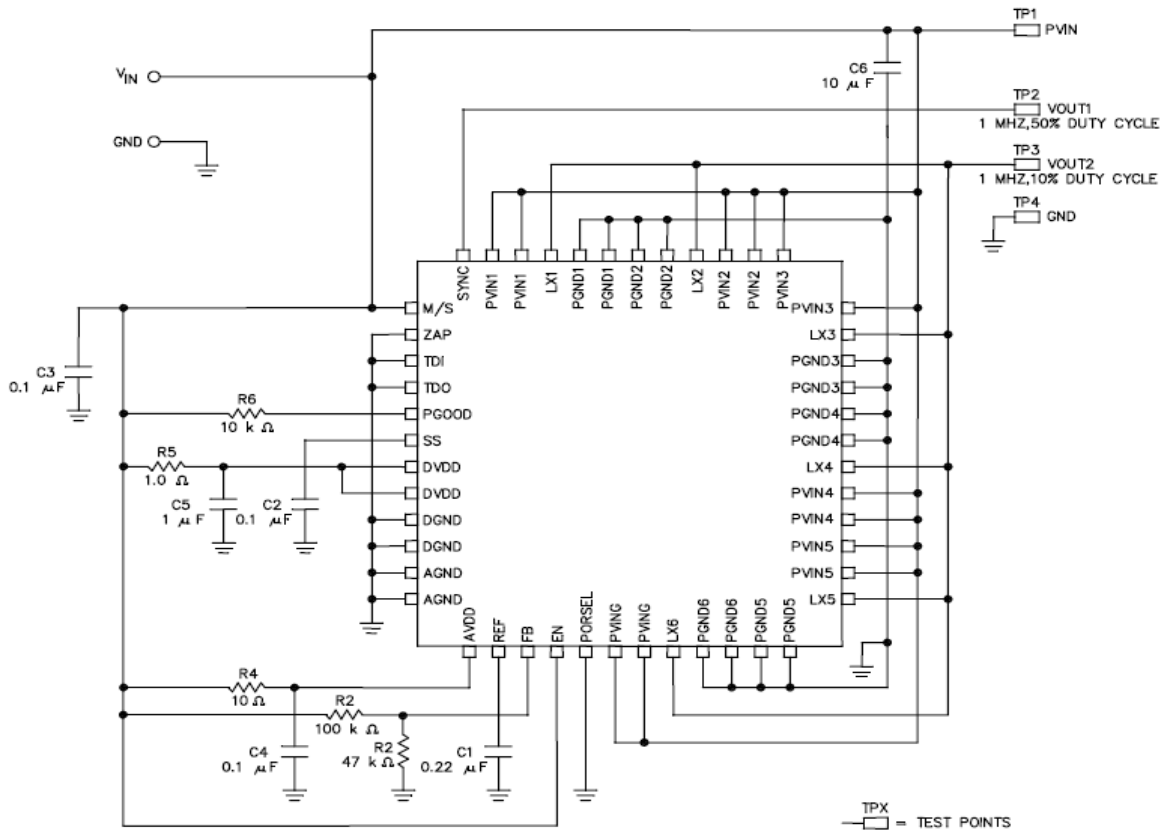
### 4.1 Irradiation Facilities

High dose rate testing was performed using a Gammacell 220 <sup>60</sup>Co irradiator located in the Palm Bay, Florida Intersil facility. Low dose rate testing used a J. L. Shepherd and Associates (JLS) low dose rate <sup>60</sup>Co model 484 irradiator located in the same facility. The high dose rate irradiations were done at 55 rad(Si)/s and the low dose rate work was performed at 0.010 rad(Si)/s, both per

MIL-STD-883 Method 1019.7. Dosimetry for both tests was performed using Far West Technology radiochromic dosimeters and on-site readout equipment. A PbAl box was used to shield the test fixture and devices under test against low energy secondary gamma radiation.

### 4.2 Test Fixturing

Figure 2 shows the configuration used for biased irradiation in conformance with Standard Microcircuit Drawing (SMD) 5962-09225. This configuration was used for low and high dose rate testing.



**NOTES:**

- $V_{IN} = +5.5\text{ V}, -0\text{ V}, +0.2\text{ V}$
- $I_{CC} = 50\text{ mA per part}$
- TP1 PVIN =  $V_{IN}$
- TP2 VOUT1 = 1 MHz 50% duty cycle
- TP3 VOUT2 = 1 MHz 10% duty cycle
- TP4 = GND

**Figure 2:** Irradiation bias configuration for the ISL70001SRH per Standard Microcircuit Drawing (SMD) 5962-09225

### **4.3 Characterization equipment and procedures**

All electrical testing was performed outside the irradiator using the production automated test equipment (ATE) with datalogging at each downpoint. Downpoint electrical testing was performed at room temperature.

### **4.4 Experimental matrix**

Testing proceeded in accordance with the guidelines of MIL-STD-883 Test Method 1019.7. The experimental matrix consisted of five samples irradiated at high dose rate with all pins grounded, five samples irradiated at high dose rate under bias, five samples irradiated at low dose rate with all pins grounded and five samples irradiated at low dose rate under bias. One control unit was used.

Samples of the ISL70001SRH were drawn from preproduction lots Lot I2J43H00YG, wafer V03I6HW; lot I2K14H00YG, wafer VB3FLJW and lot I2K14H01YG, wafer AIBWBPW. Samples were packaged in the standard hermetic 48-pin ceramic quad flatpack (CQFP) production package. Samples were processed through the standard burnin cycle before irradiation, as required by MIL-STD-883, and were screened to the SMD 5962-09225 limits at room, low and high temperatures before the start of total dose testing.

### **4.5 Downpoints**

Downpoints for both dose rates were 0 krad(Si), 10 krad(Si), 25 krad(Si), 50 krad(Si), 100 krad(Si) and 150 krad(Si).

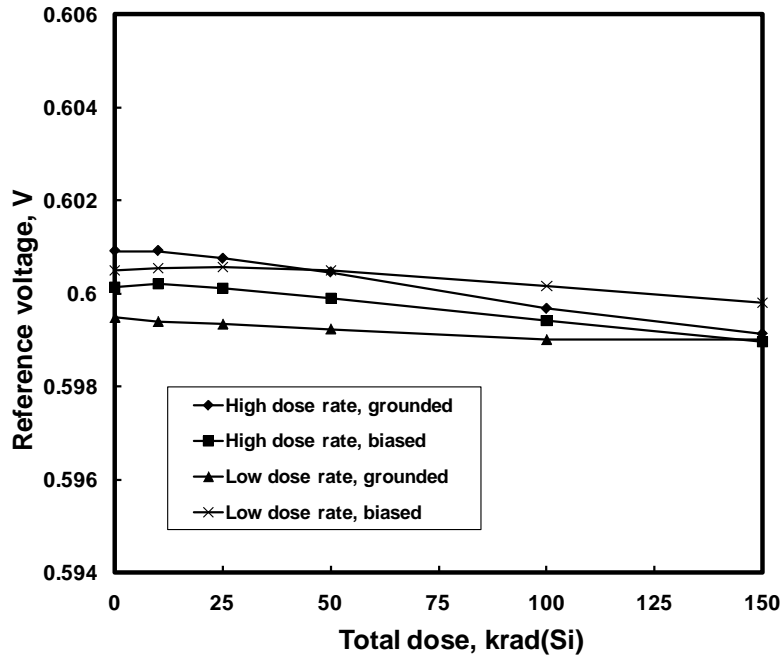
## **5: Results**

### **5.1 Test results**

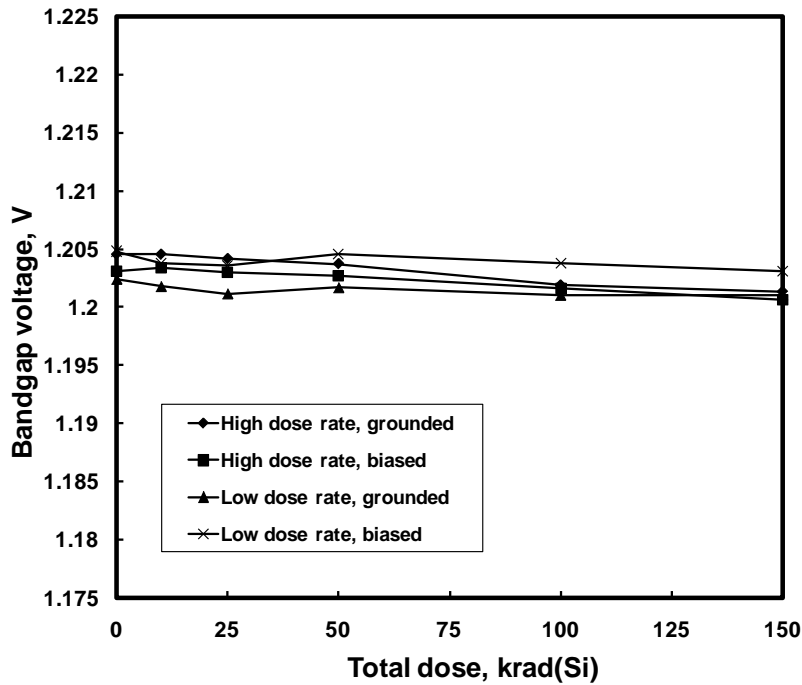
The high and low dose rate tests of the ISL70001SRH are complete and showed no reject devices after irradiation to 150 krad(Si), screening to the SMD post-irradiation limits.

### **5.2 Variables data**

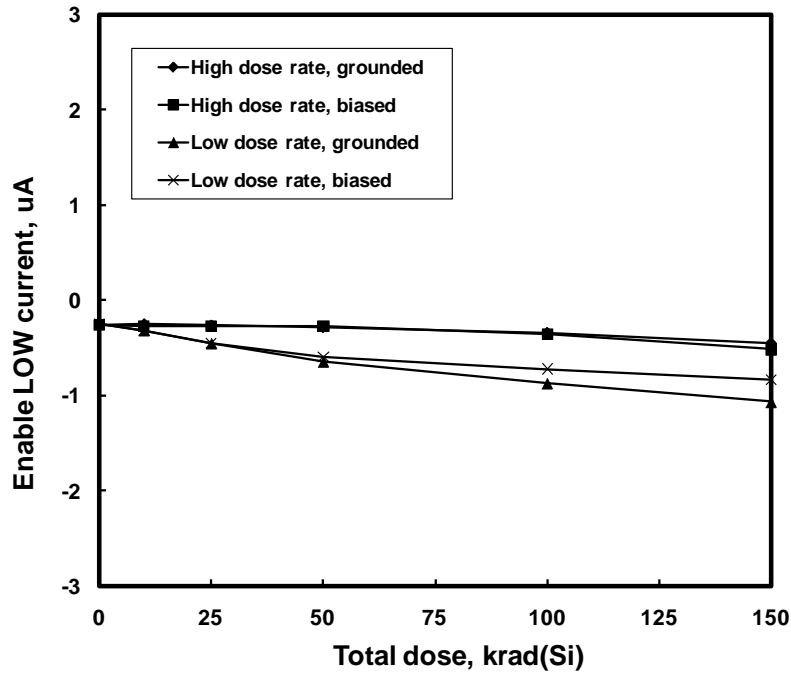
The ISL70001SRH is a very complex part with some 250 datalogged parameters, and plotting all parameters would be a lengthy undertaking. The plots in Figures 3 through 49 show data for 47 key parameters at all downpoints. The plots show the median as a function of total dose for each of the irradiation conditions; we chose to use the median because of the relatively small sample sizes. All parts showed excellent stability over irradiation, with no observed low dose rate sensitivity. Several parameters (such as the bandgap voltage, the error amplifier offset voltage and the feedback adjust margins) are informational in nature and are not specified in either the data sheet or the SMD, and as a result these parameters do not have formal parametric limits.



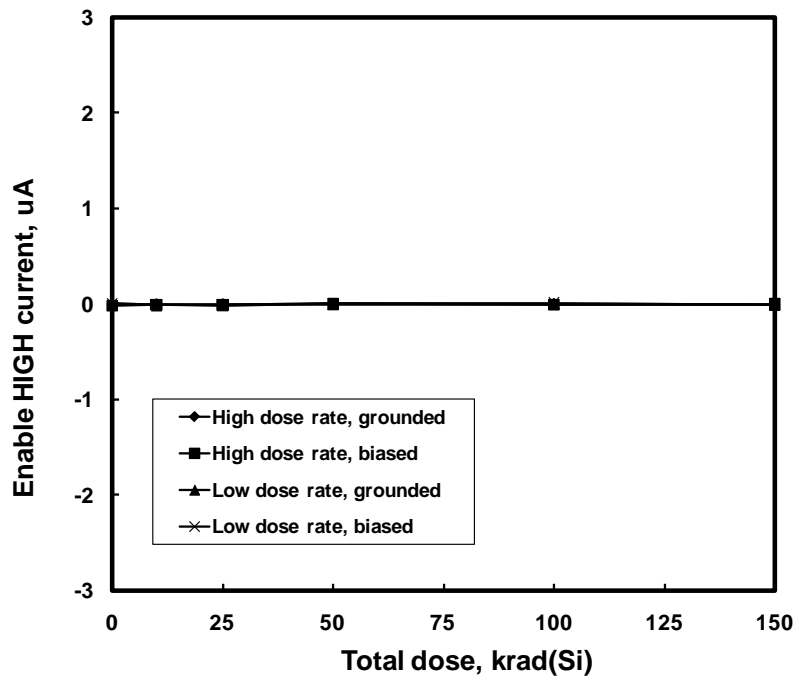
**Figure 3:** ISL70001SRH reference voltage as a function of total dose irradiation at low and high dose rate for the unbiased (all pins grounded) and the biased (per Figure 2) cases. The low dose rate was 0.01 rad(Si)/s and the high dose rate was 55 rad(Si)/s. Sample size for each cell was 5. The SMD limit is 0.594 – 0.606V post-irradiation.



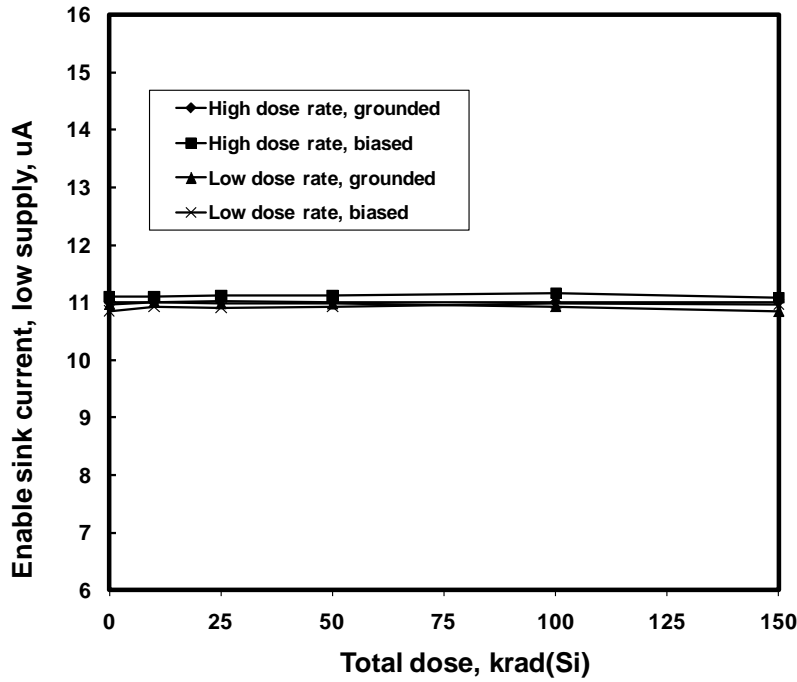
**Figure 4:** ISL70001SRH bandgap voltage as a function of total dose irradiation at low and high dose rate for the unbiased (all pins grounded) and the biased (per Figure 2) cases. The low dose rate was 0.01 rad(Si)/s and the high dose rate was 55 rad(Si)/s. Sample size for each cell was 5. Bandgap voltage is an informational parameter and is not formally specified.



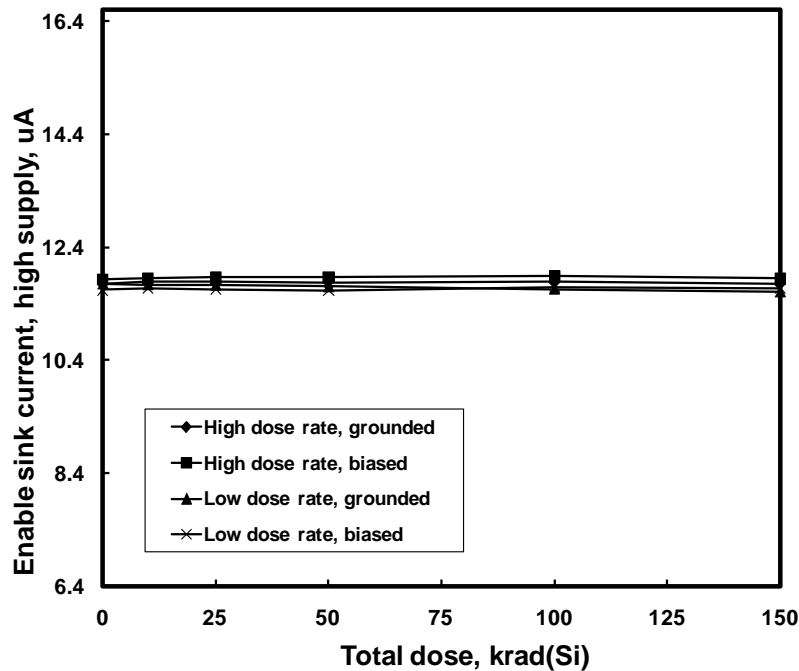
**Figure 5:** ISL70001SRH enable input LOW leakage current as a function of total dose irradiation at low and high dose rate for the unbiased (all pins grounded) and the biased (per Figure 2) cases. The low dose rate was 0.01 rad(Si)/s and the high dose rate was 55 rad(Si)/s. Sample size for each cell was 5. The SMD limits are -3 to 3 $\mu$ A post-irradiation.



**Figure 6:** ISL70001SRH enable input HIGH leakage current as a function of total dose irradiation at low and high dose rate for the unbiased (all pins grounded) and the biased (per Figure 2) cases. The low dose rate was 0.01 rad(Si)/s and the high dose rate was 55 rad(Si)/s. Sample size for each cell was 5. The SMD limits are -3 to 3 $\mu$ A post-irradiation.

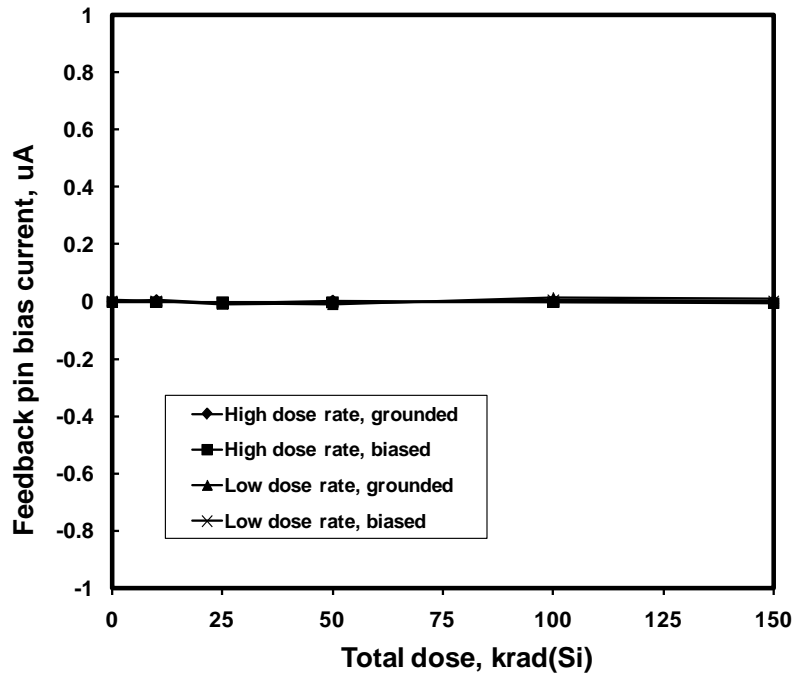


**Figure 7:** ISL70001SRH enable sink current (low supply) as a function of total dose irradiation at low and high dose rate for the unbiased (all pins grounded) and the biased (per Figure 2) cases. The low dose rate was 0.01 rad(Si)/s and the high dose rate was 55 rad(Si)/s. Sample size for each cell was 5. The SMD limits are 6.4 to 16.6 $\mu$ A post-irradiation.

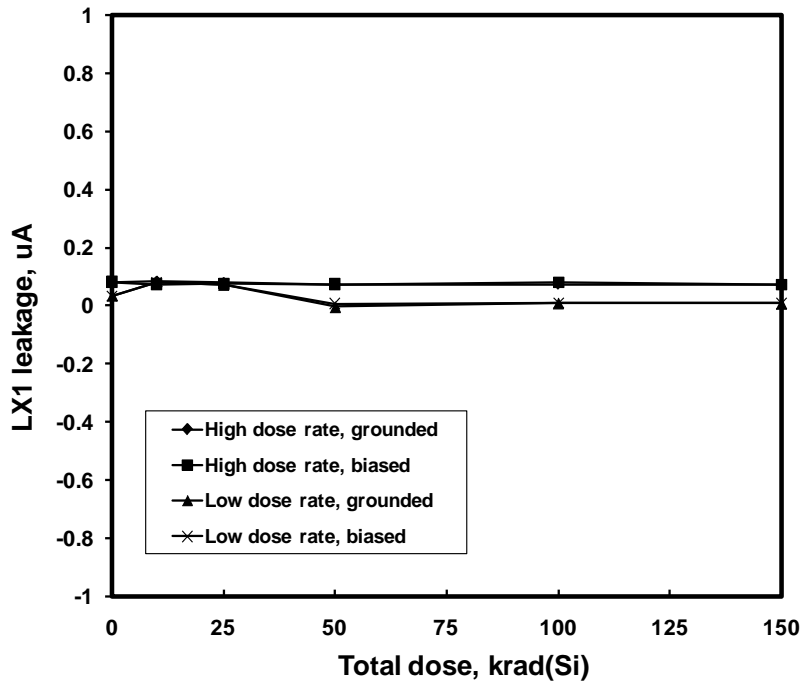


**Figure 8:** ISL70001SRH enable sink current (high supply) as a function of total dose irradiation at low and high dose rate for the unbiased (all pins grounded) and the biased (per Figure 2) cases. The low dose rate was 0.01 rad(Si)/s and the high dose rate was 55 rad(Si)/s. Sample size for each cell was 5. The SMD limits are 6.4 to 16.6 $\mu$ A post-irradiation.

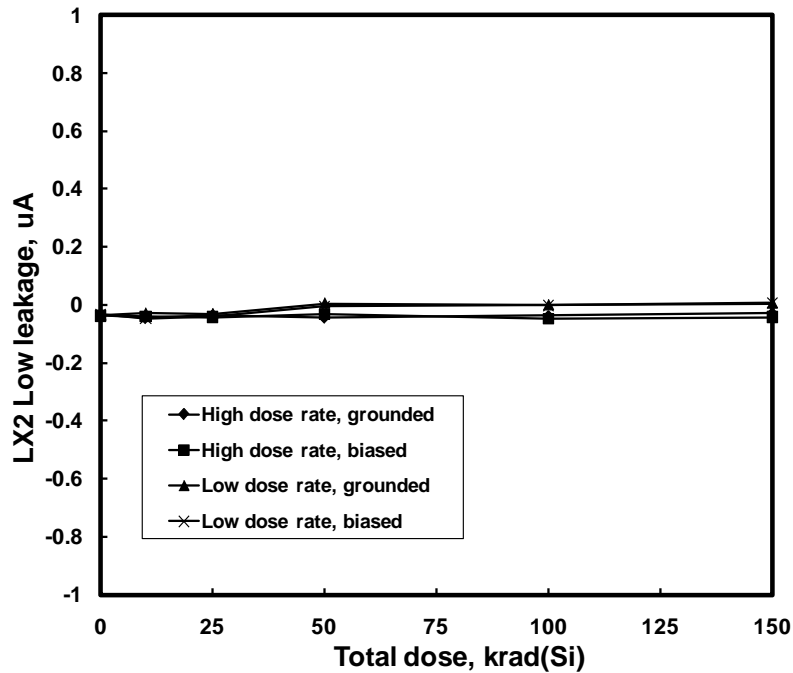




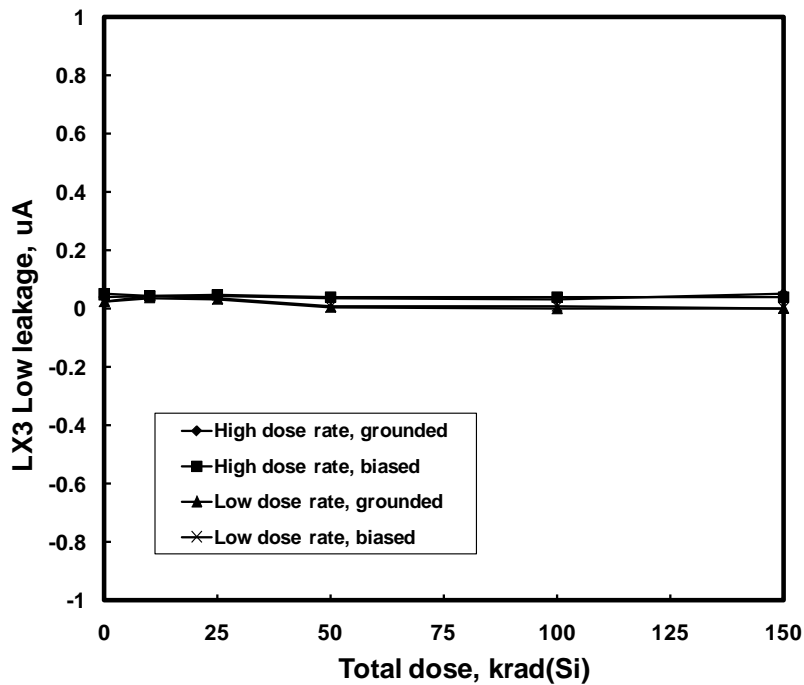
**Figure 9:** ISL70001SRH feedback input bias current as a function of total dose irradiation at low and high dose rate for the unbiased (all pins grounded) and the biased (per Figure 2) cases. The low dose rate was 0.01 rad(Si)/s and the high dose rate was 55 rad(Si)/s. Sample size for each cell was 5. The SMD limit is -1 to 1 $\mu$ A post-irradiation.



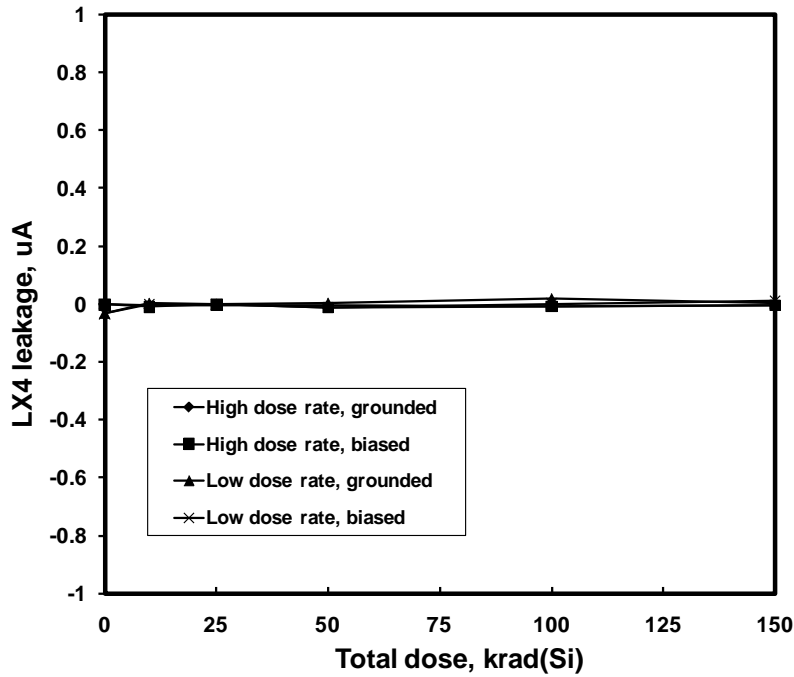
**Figure 10:** ISL70001SRH LX1 LOW leakage current as a function of total dose irradiation at low and high dose rate for the unbiased (all pins grounded) and the biased (per Figure 2) cases. The low dose rate was 0.01 rad(Si)/s and the high dose rate was 55 rad(Si)/s. Sample size for each cell was 5. The SMD limit is -1 $\mu$ A minimum post-irradiation.



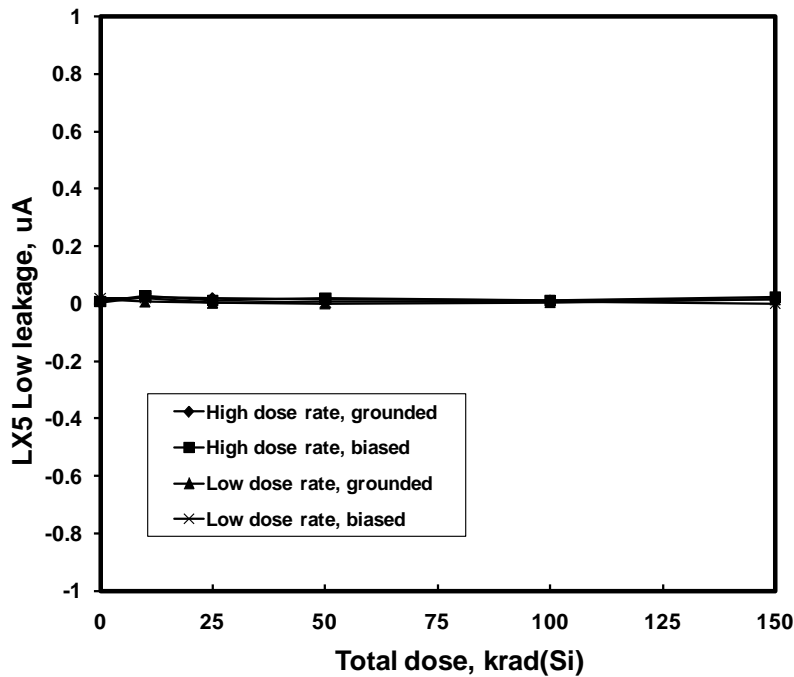
**Figure 11:** ISL70001SRH LX2 LOW leakage current as a function of total dose irradiation at low and high dose rate for the unbiased (all pins grounded) and the biased (per Figure 2) cases. The low dose rate was 0.01 rad(Si)/s and the high dose rate was 55 rad(Si)/s. Sample size for each cell was 5. The SMD limit is  $-1\mu\text{A}$  minimum post-irradiation.



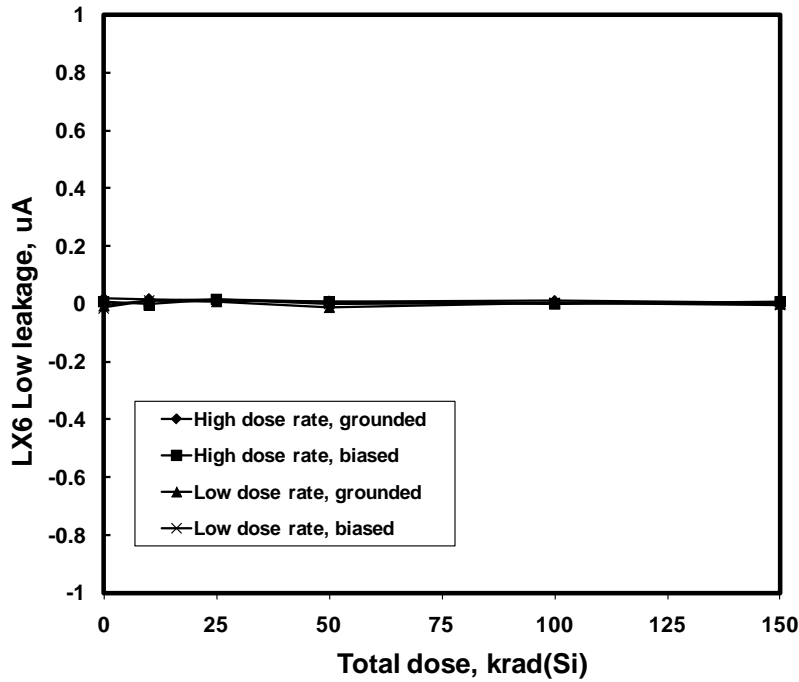
**Figure 12:** ISL70001SRH LX3 LOW leakage current as a function of total dose irradiation at low and high dose rate for the unbiased (all pins grounded) and the biased (per Figure 2) cases. The low dose rate was 0.01 rad(Si)/s and the high dose rate was 55 rad(Si)/s. Sample size for each cell was 5. The SMD limit is  $-1\mu\text{A}$  minimum post-irradiation.



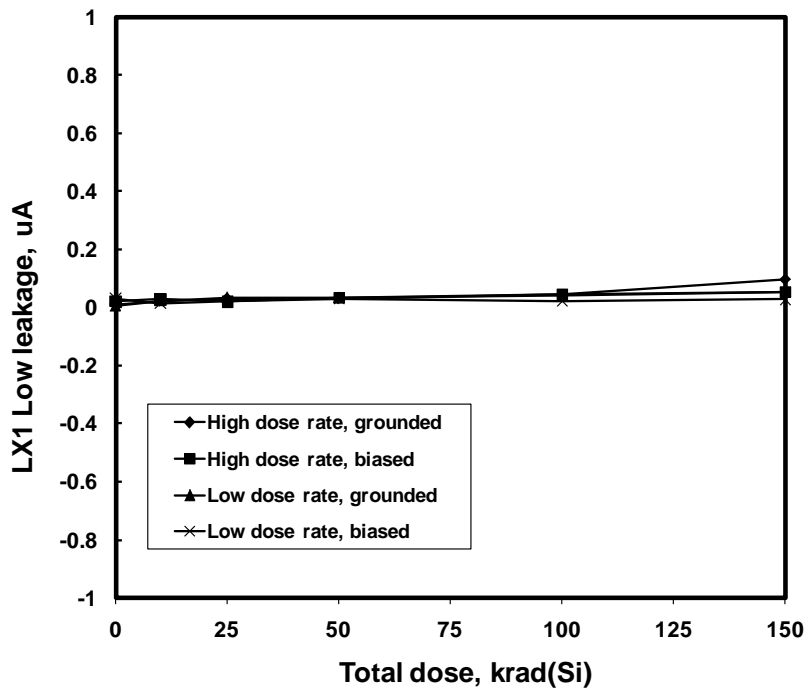
**Figure 13:** ISL70001SRH LX4 LOW leakage current as a function of total dose irradiation at low and high dose rate for the unbiased (all pins grounded) and the biased (per Figure 2) cases. The low dose rate was 0.01 rad(Si)/s and the high dose rate was 55 rad(Si)/s. Sample size for each cell was 5. The SMD limit is -1 $\mu$ A minimum post-irradiation.



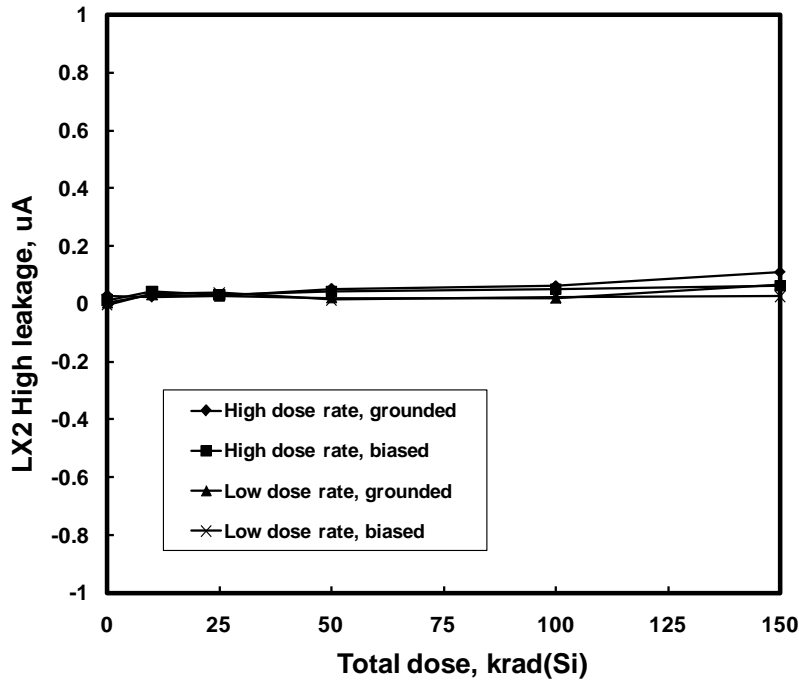
**Figure 14:** ISL70001SRH LX5 LOW leakage current as a function of total dose irradiation at low and high dose rate for the unbiased (all pins grounded) and the biased (per Figure 2) cases. The low dose rate was 0.01 rad(Si)/s and the high dose rate was 55 rad(Si)/s. Sample size for each cell was 5. The SMD limit is -1 $\mu$ A minimum post-irradiation.



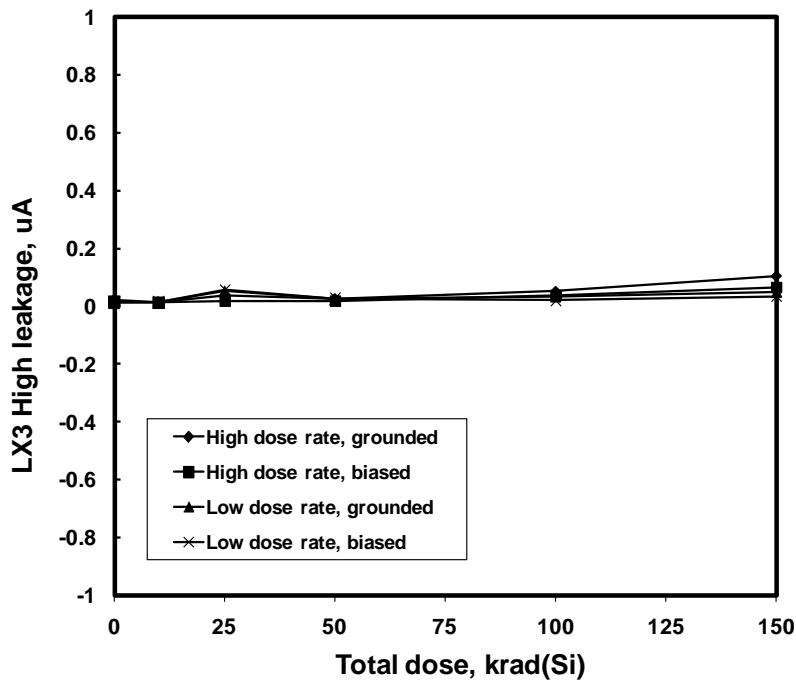
**Figure 15:** ISL70001SRH LX6 LOW leakage current as a function of total dose irradiation at low and high dose rate for the unbiased (all pins grounded) and the biased (per Figure 2) cases. The low dose rate was 0.01 rad(Si)/s and the high dose rate was 55 rad(Si)/s. Sample size for each cell was 5. The SMD limit is -1 $\mu$ A minimum post-irradiation.



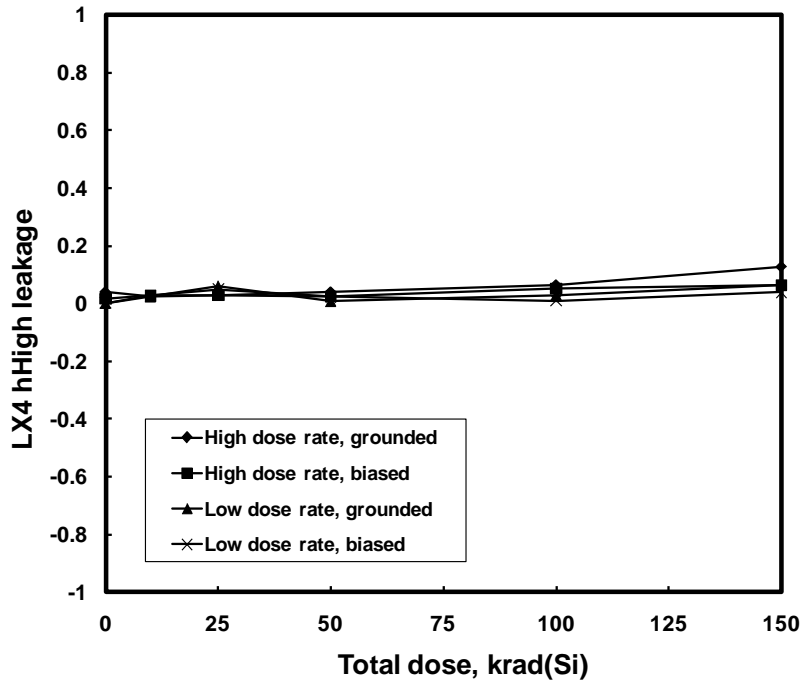
**Figure 16:** ISL70001SRH LX1 HIGH leakage current as a function of total dose irradiation at low and high dose rate for the unbiased (all pins grounded) and the biased (per Figure 2) cases. The low dose rate was 0.01 rad(Si)/s and the high dose rate was 55 rad(Si)/s. Sample size for each cell was 5. The SMD limit is 15 $\mu$ A maximum post-irradiation.



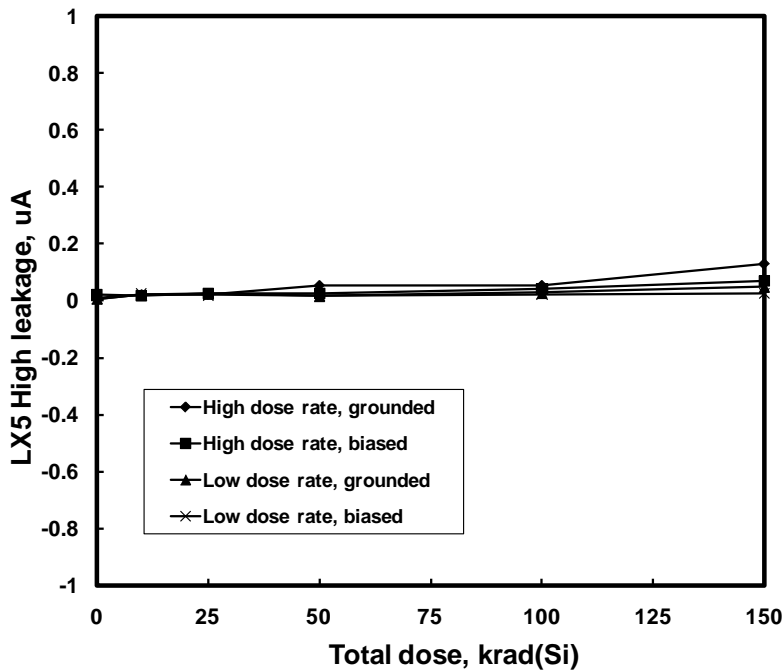
**Figure 17:** ISL70001SRH LX2 HIGH leakage current as a function of total dose irradiation at low and high dose rate for the unbiased (all pins grounded) and the biased (per Figure 2) cases. The low dose rate was 0.01 rad(Si)/s and the high dose rate was 55 rad(Si)/s. Sample size for each cell was 5. The SMD limit is 15 $\mu$ A maximum post-irradiation.



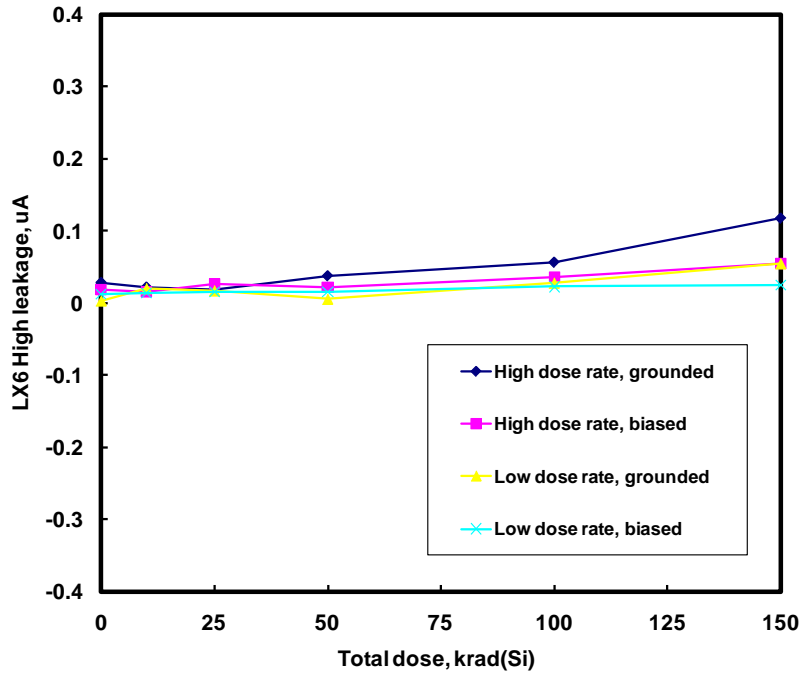
**Figure 18:** ISL70001SRH LX3 HIGH leakage current as a function of total dose irradiation at low and high dose rate for the unbiased (all pins grounded) and the biased (per Figure 2) cases. The low dose rate was 0.01 rad(Si)/s and the high dose rate was 55 rad(Si)/s. Sample size for each cell was 5. The SMD limit is 15 $\mu$ A maximum post-irradiation.



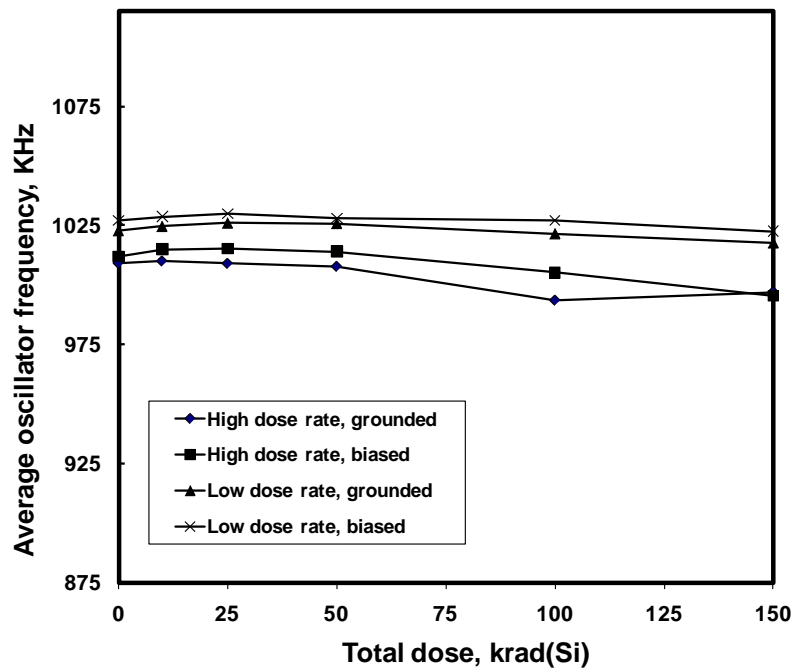
**Figure 19:** ISL70001SRH LX4 HIGH leakage current as a function of total dose irradiation at low and high dose rate for the unbiased (all pins grounded) and the biased (per Figure 2) cases. The low dose rate was 0.01 rad(Si)/s and the high dose rate was 55 rad(Si)/s. Sample size for each cell was 5. The SMD limit is 15 $\mu$ A maximum post-irradiation.



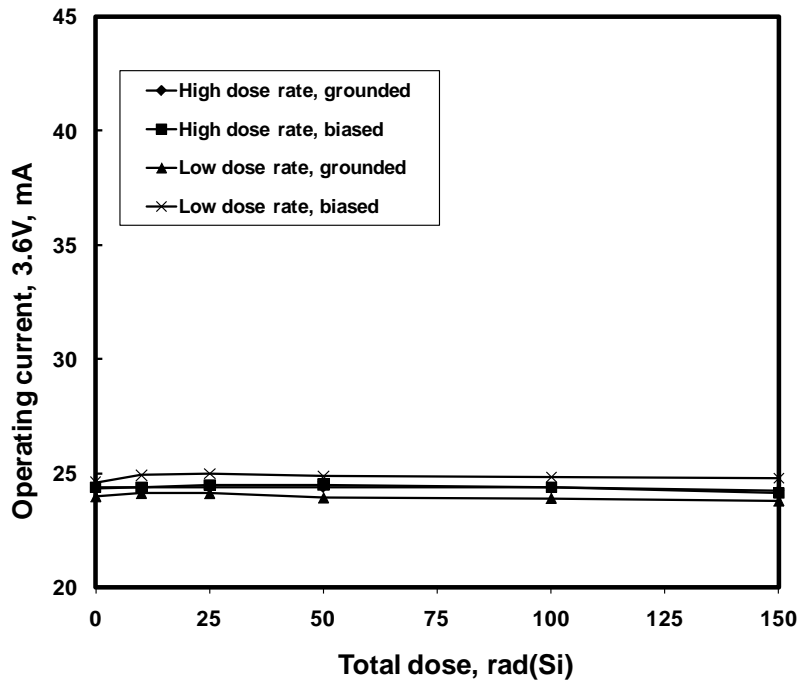
**Figure 20:** ISL70001SRH LX5 HIGH leakage current as a function of total dose irradiation at low and high dose rate for the unbiased (all pins grounded) and the biased (per Figure 2) cases. The low dose rate was 0.01 rad(Si)/s and the high dose rate was 55 rad(Si)/s. Sample size for each cell was 5. The SMD limit is 15 $\mu$ A maximum post-irradiation.



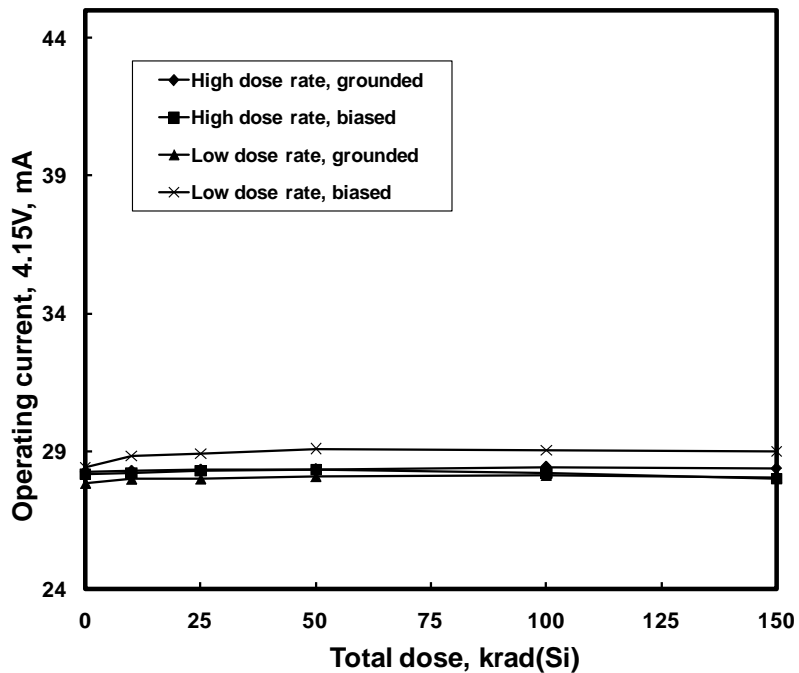
**Figure 21:** ISL70001SRH LX6 HIGH leakage current as a function of total dose irradiation at low and high dose rate for the unbiased (all pins grounded) and the biased (per Figure 2) cases. The low dose rate was 0.01 rad(Si)/s and the high dose rate was 55 rad(Si)/s. Sample size for each cell was 5. The SMD limit is 15 $\mu$ A maximum post-irradiation.



**Figure 22:** ISL70001SRH average oscillator frequency as a function of total dose irradiation at low and high dose rate for the unbiased (all pins grounded) and the biased (per Figure 2) cases. The low dose rate was 0.01 rad(Si)/s and the high dose rate was 55 rad(Si)/s. Sample size for each cell was 5. The SMD limits are 850 – 1150KHz post-irradiation.

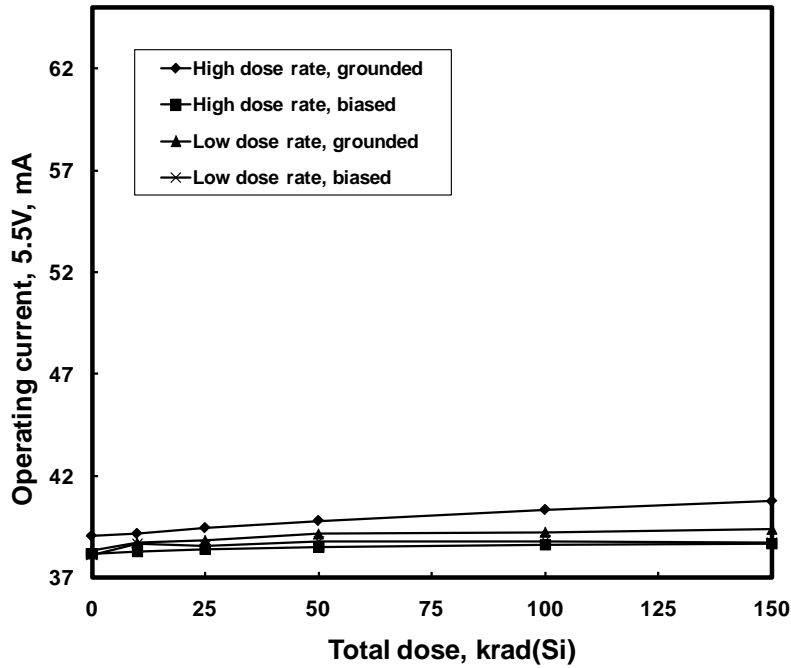


**Figure 23:** ISL70001SRH operating current at 3.6V supply voltage as a function of total dose irradiation at low and high dose rate for the unbiased (all pins grounded) and the biased (per Figure 2) cases. The low dose rate was 0.01 rad(Si)/s and the high dose rate was 55 rad(Si)/s. Sample size for each cell was 5. The SMD limit is 45mA maximum post-irradiation.

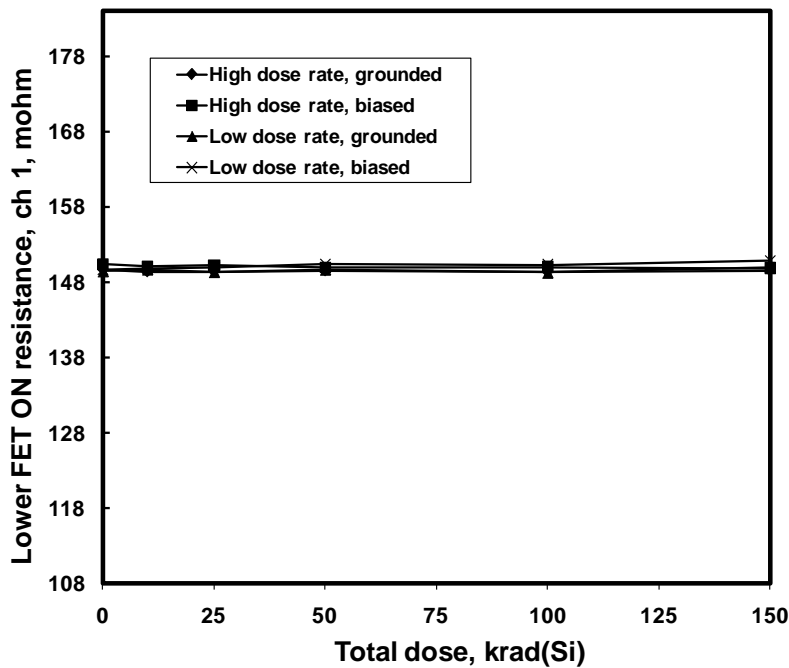


**Figure 24:** ISL70001SRH operating current at 4.15V supply voltage as a function of total dose irradiation at low and high dose rate for the unbiased (all pins grounded) and the biased (per Figure 2) cases. The low dose rate was 0.01 rad(Si)/s and the high dose rate was 55 rad(Si)/s. Sample size for each cell was 5. Operating current at 4.14V is an informational parameter and is not formally specified.

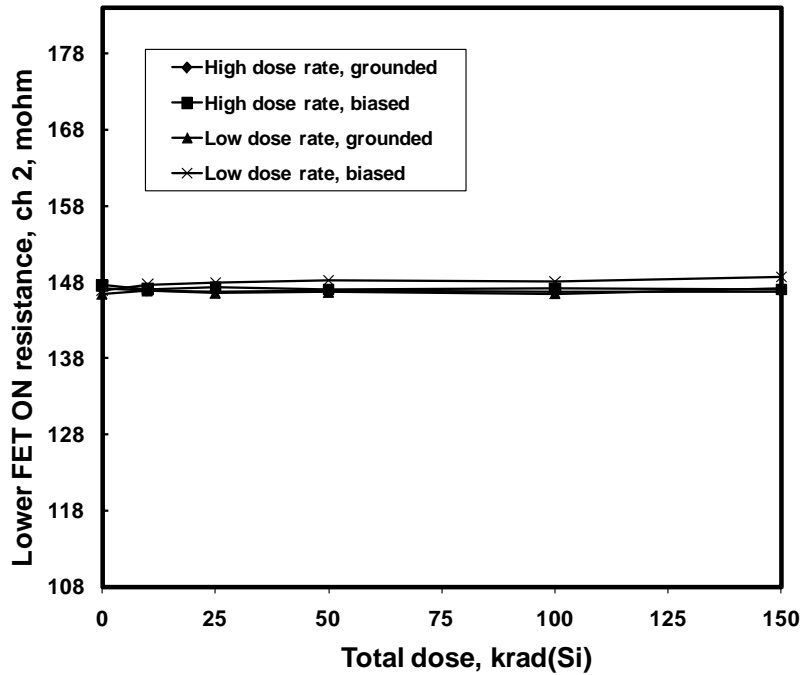




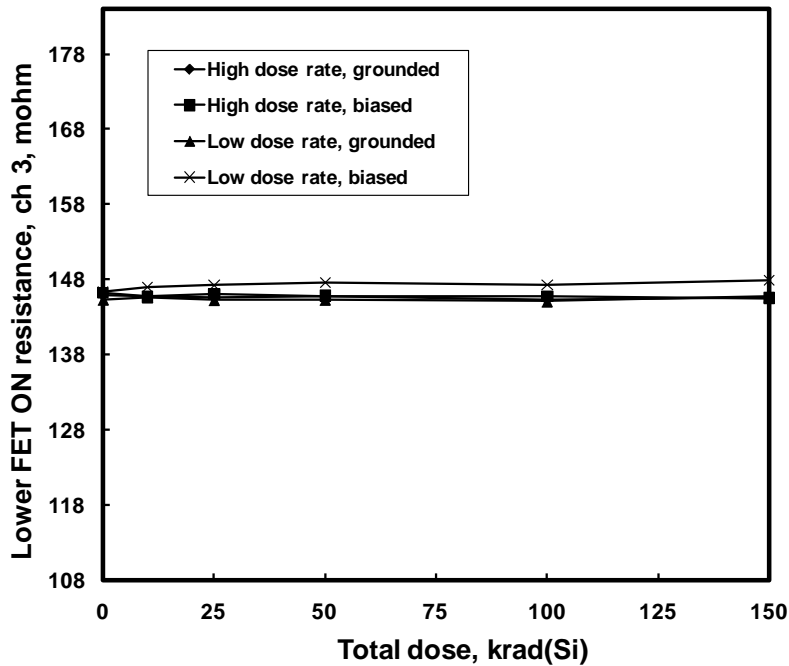
**Figure 25:** ISL70001SRH operating current at 5.5V supply voltage as a function of total dose irradiation at low and high dose rate for the unbiased (all pins grounded) and the biased (per Figure 2) cases. The low dose rate was 0.01 rad(Si)/s and the high dose rate was 55 rad(Si)/s. Sample size for each cell was 5. The SMD limit is 65mA maximum post-irradiation.



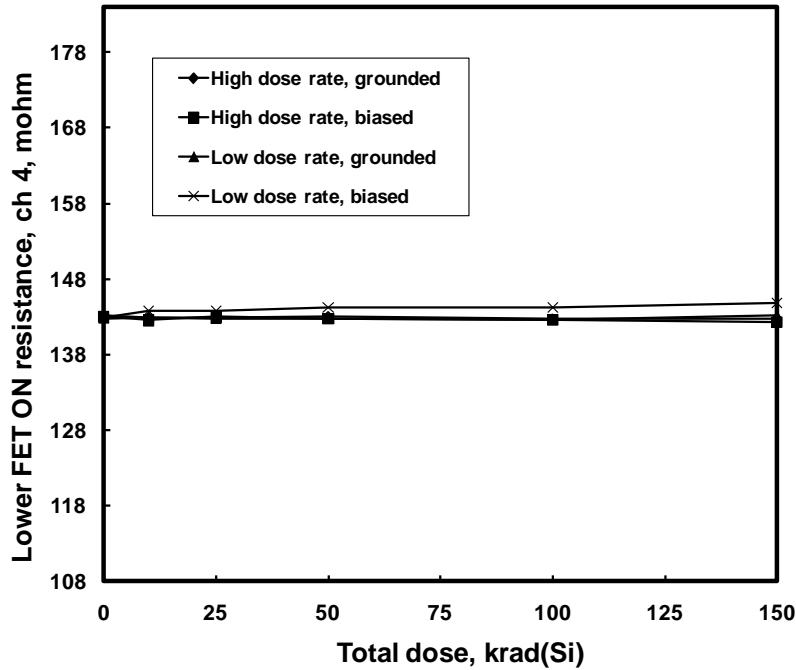
**Figure 26:** ISL70001SRH channel 1 lower FET Rds(ON) resistance as a function of total dose irradiation at low and high dose rate for the unbiased (all pins grounded) and the biased (per Figure 2) cases. The low dose rate was 0.01 rad(Si)/s and the high dose rate was 55 rad(Si)/s. Sample size for each cell was 5. The SMD limit is 108-184 milliohms post-irradiation.



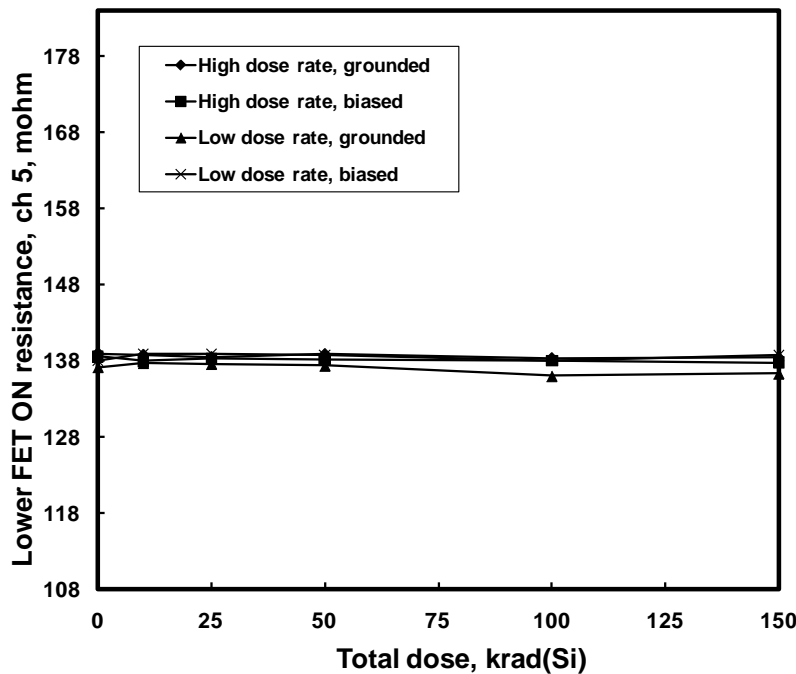
**Figure 27:** ISL70001SRH channel 2 lower FET Rds(ON) resistance as a function of total dose irradiation at low and high dose rate for the unbiased (all pins grounded) and the biased (per Figure 2) cases. The low dose rate was 0.01 rad(Si)/s and the high dose rate was 55 rad(Si)/s. Sample size for each cell was 5. The SMD limit is 108-184 milliohms post-irradiation.



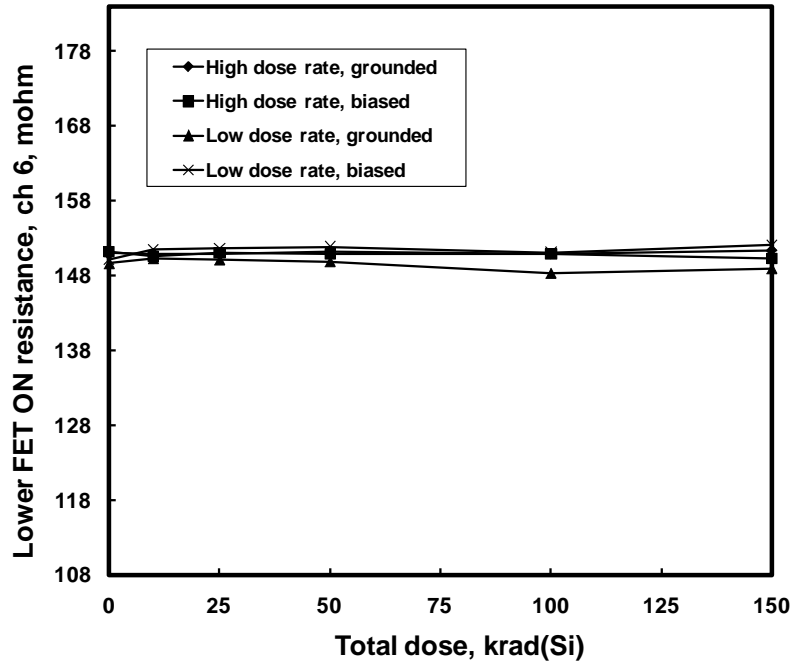
**Figure 28:** ISL70001SRH channel 3 lower FET Rds(ON) resistance as a function of total dose irradiation at low and high dose rate for the unbiased (all pins grounded) and the biased (per Figure 2) cases. The low dose rate was 0.01 rad(Si)/s and the high dose rate was 55 rad(Si)/s. Sample size for each cell was 5. The SMD limit is 108-184 milliohms post-irradiation.



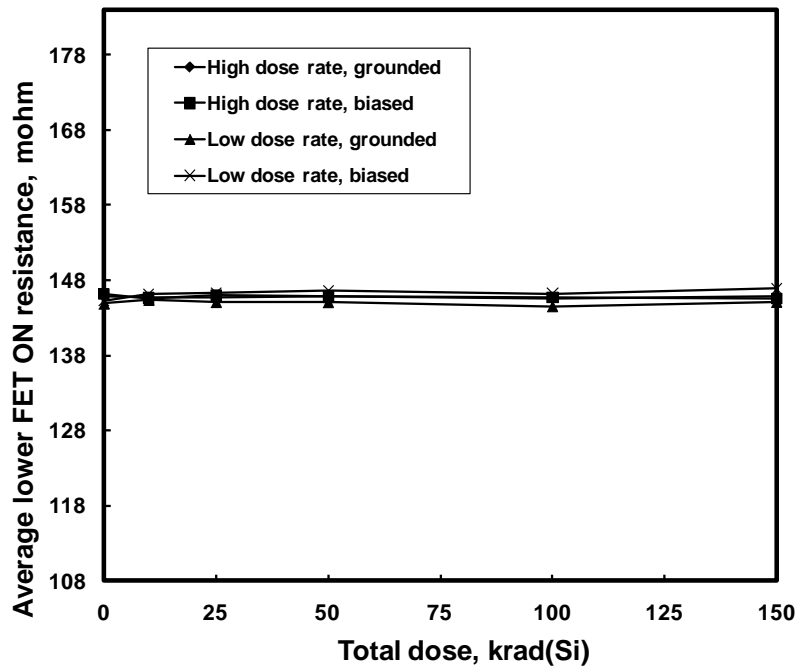
**Figure 29:** ISL70001SRH channel 4 lower FET Rds(ON) resistance as a function of total dose irradiation at low and high dose rate for the unbiased (all pins grounded) and the biased (per Figure 2) cases. The low dose rate was 0.01 rad(Si)/s and the high dose rate was 55 rad(Si)/s. Sample size for each cell was 5. The SMD limit is 108-184 milliohms post-irradiation.



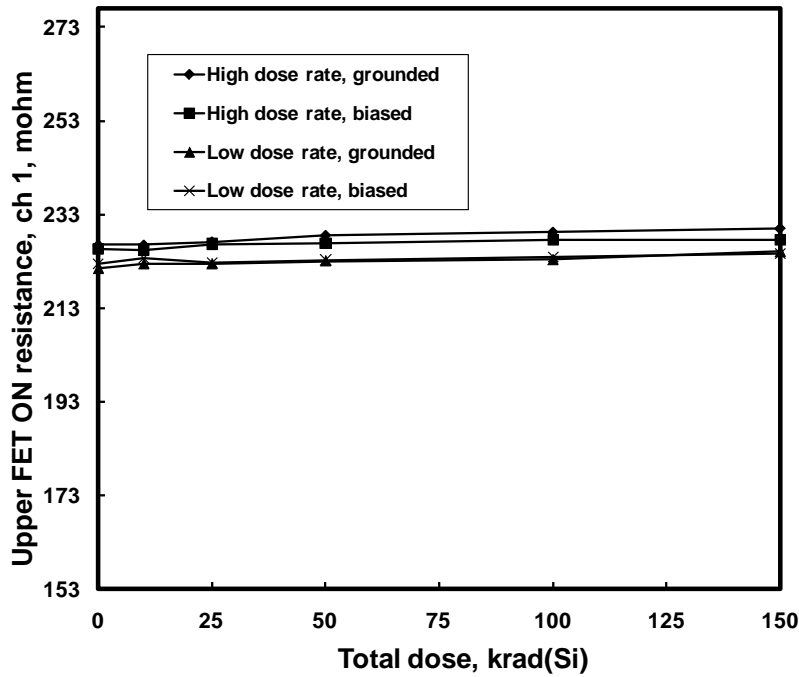
**Figure 30:** ISL70001SRH channel 5 lower FET Rds(ON) resistance as a function of total dose irradiation at low and high dose rate for the unbiased (all pins grounded) and the biased (per Figure 2) cases. The low dose rate was 0.01 rad(Si)/s and the high dose rate was 55 rad(Si)/s. Sample size for each cell was 5. The SMD limit is 108-184 milliohms post-irradiation.



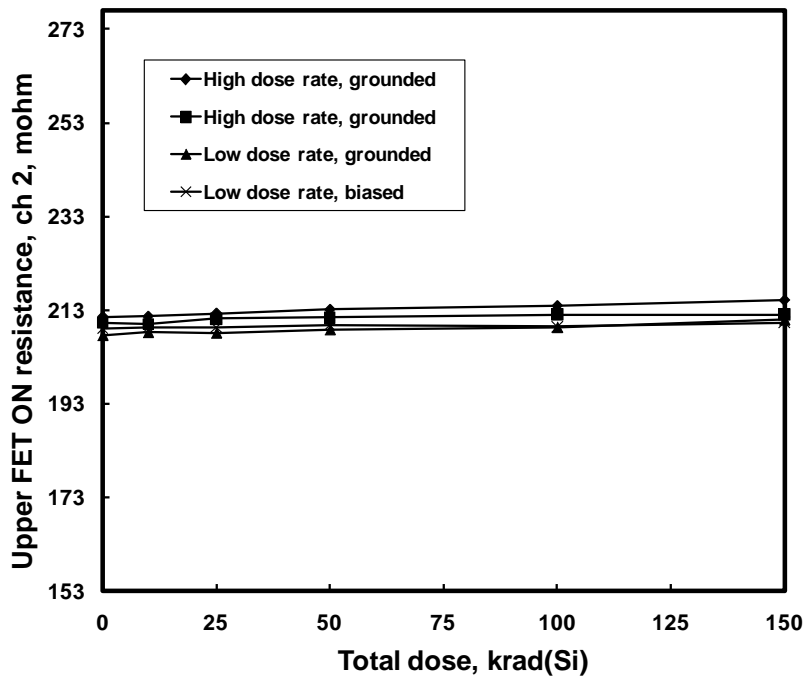
**Figure 31:** ISL70001SRH channel 6 lower FET Rds(ON) resistance as a function of total dose irradiation at low and high dose rate for the unbiased (all pins grounded) and the biased (per Figure 2) cases. The low dose rate was 0.01 rad(Si)/s and the high dose rate was 55 rad(Si)/s. Sample size for each cell was 5. The SMD limit is 108-184 milliohms post-irradiation.



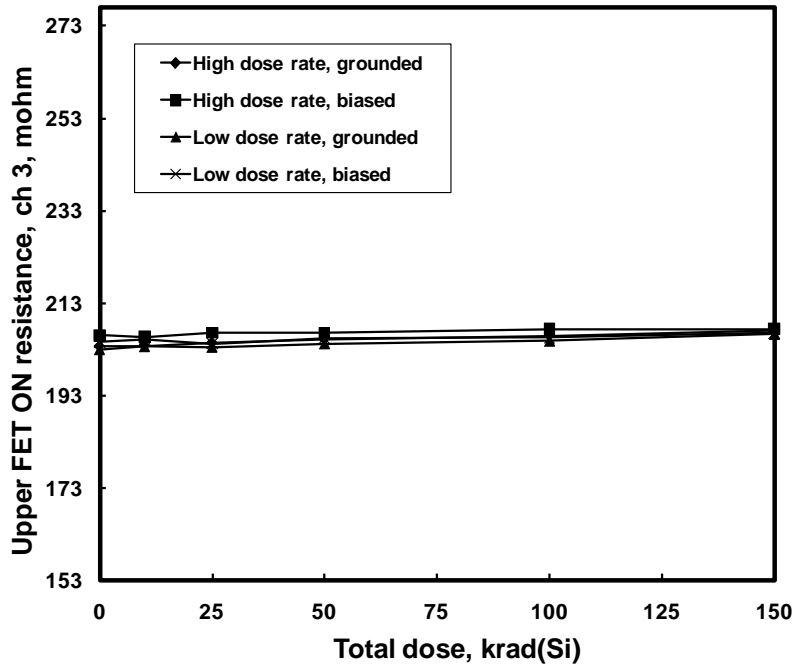
**Figure 32:** ISL70001SRH average lower FET Rds(ON) resistance as a function of total dose irradiation at low and high dose rate for the unbiased (all pins grounded) and the biased (per Figure 2) cases. The low dose rate was 0.01 rad(Si)/s and the high dose rate was 55 rad(Si)/s. Sample size for each cell was 5. Average lower FET Rds(on) resistance is an informational parameter and is not formally specified.



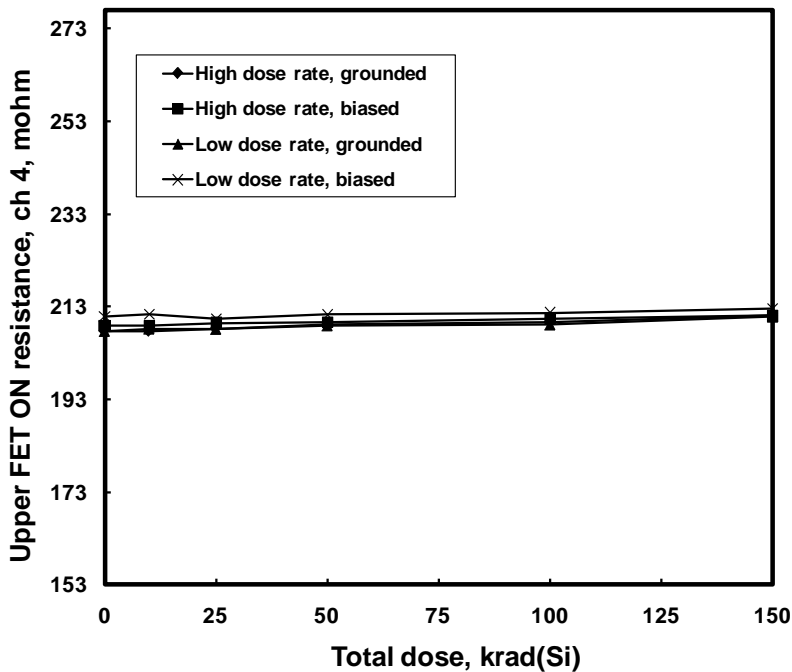
**Figure 33:** ISL70001SRH channel 1 upper FET Rds(ON) resistance as a function of total dose irradiation at low and high dose rate for the unbiased (all pins grounded) and the biased (per Figure 2) cases. The low dose rate was 0.01 rad(Si)/s and the high dose rate was 55 rad(Si)/s. Sample size for each cell was 5. The SMD limit is 153-277 milliohms post-irradiation.



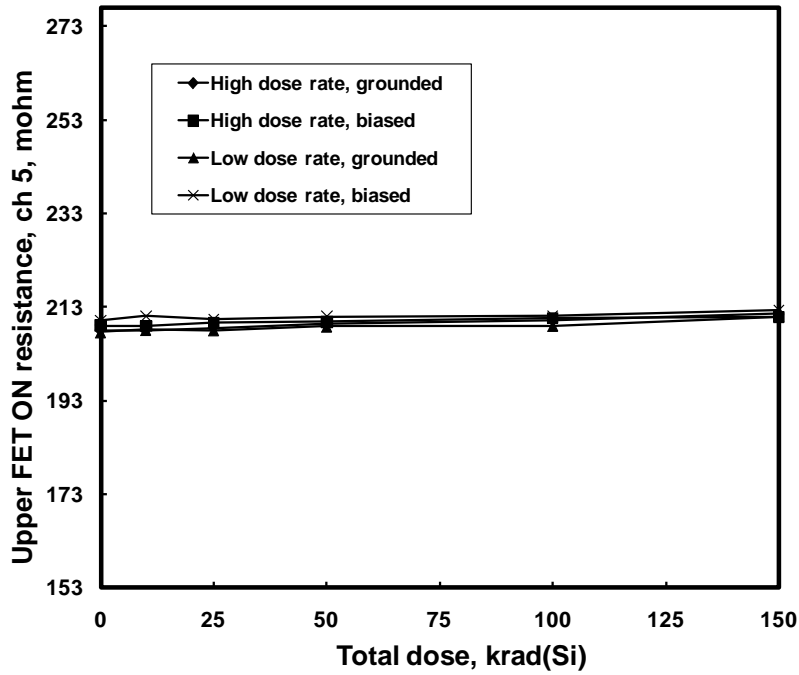
**Figure 34:** ISL70001SRH channel 2 upper FET Rds(ON) resistance as a function of total dose irradiation at low and high dose rate for the unbiased (all pins grounded) and the biased (per Figure 2) cases. The low dose rate was 0.01 rad(Si)/s and the high dose rate was 55 rad(Si)/s. Sample size for each cell was 5. The SMD limit is 153-277 milliohms post-irradiation.



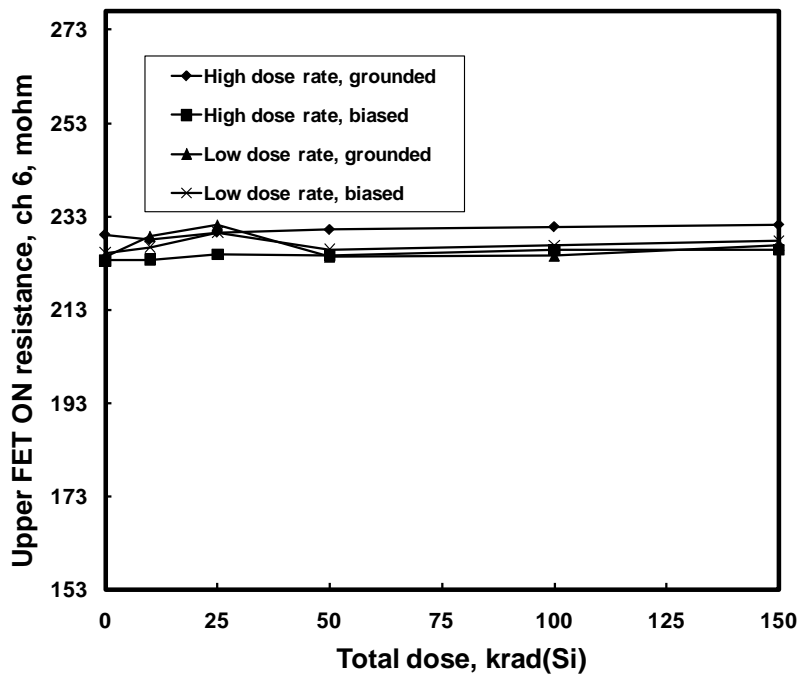
**Figure 35:** ISL70001SRH channel 3 upper FET Rds(ON) resistance as a function of total dose irradiation at low and high dose rate for the unbiased (all pins grounded) and the biased (per Figure 2) cases. The low dose rate was 0.01 rad(Si)/s and the high dose rate was 55 rad(Si)/s. Sample size for each cell was 5. The SMD limit is 153-277 milliohms post-irradiation.



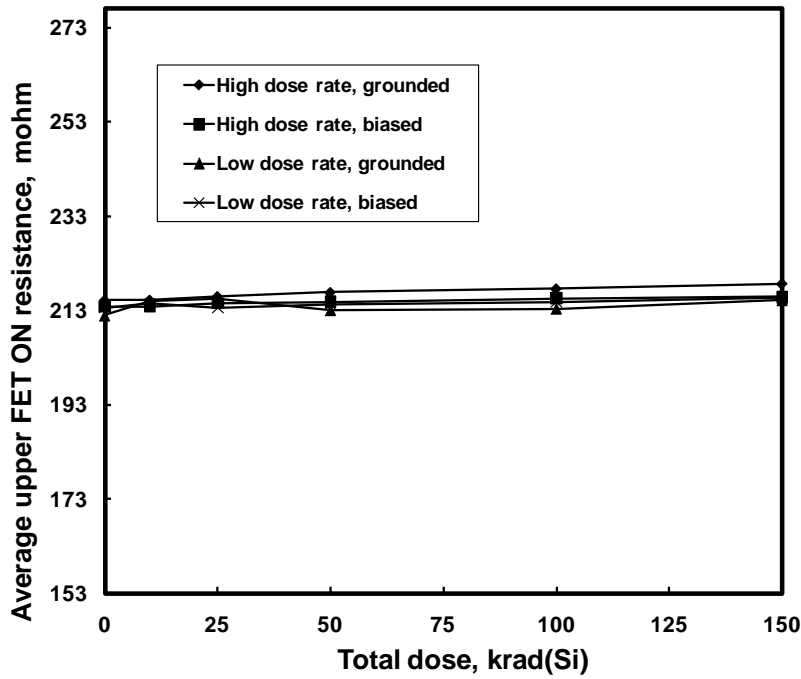
**Figure 36:** ISL70001SRH channel 4 upper FET Rds(ON) resistance as a function of total dose irradiation at low and high dose rate for the unbiased (all pins grounded) and the biased (per Figure 2) cases. The low dose rate was 0.01 rad(Si)/s and the high dose rate was 55 rad(Si)/s. Sample size for each cell was 5. The SMD limit is 153-277 milliohms post-irradiation.



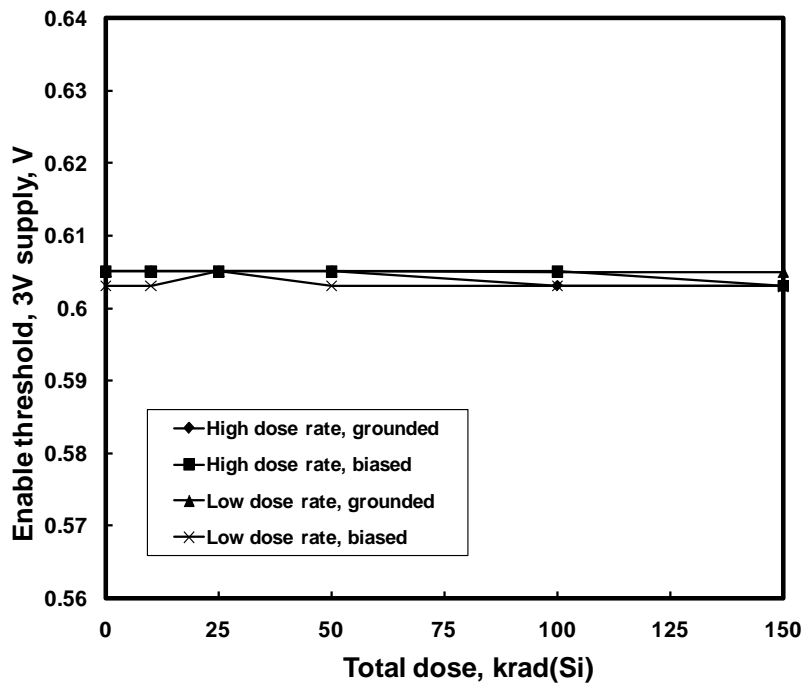
**Figure 37:** ISL70001SRH channel 5 upper FET Rds(ON) resistance as a function of total dose irradiation at low and high dose rate for the unbiased (all pins grounded) and the biased (per Figure 2) cases. The low dose rate was 0.01 rad(Si)/s and the high dose rate was 55 rad(Si)/s. Sample size for each cell was 5. The SMD limit is 153-277 milliohms post-irradiation.



**Figure 38:** ISL70001SRH channel 6 upper FET Rds(ON) resistance as a function of total dose irradiation at low and high dose rate for the unbiased (all pins grounded) and the biased (per Figure 2) cases. The low dose rate was 0.01 rad(Si)/s and the high dose rate was 55 rad(Si)/s. Sample size for each cell was 5. The SMD limit is 153-277 milliohms post-irradiation.

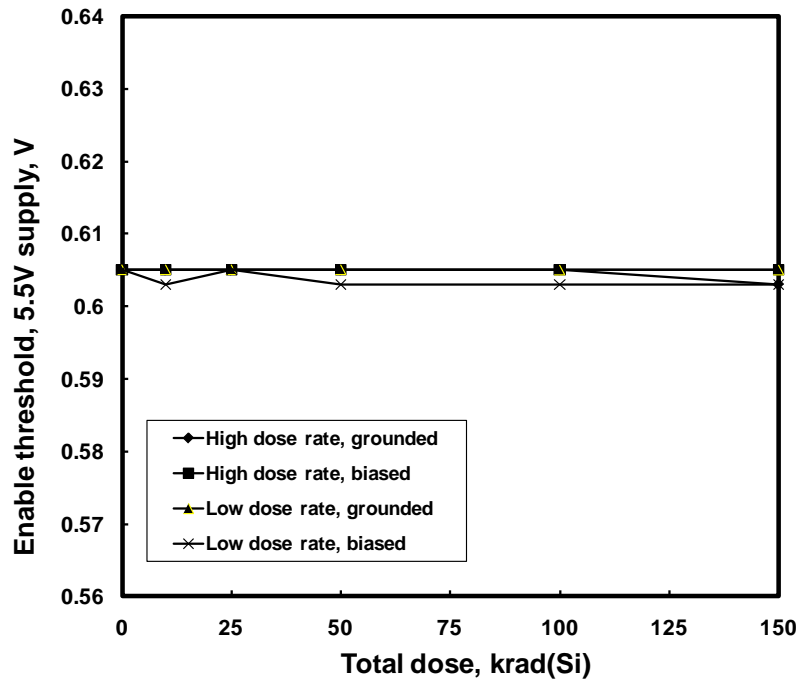


**Figure 39:** ISL70001SRH average upper FET Rds(ON) resistance as a function of total dose irradiation at low and high dose rate for the unbiased (all pins grounded) and the biased (per Figure 2) cases. The low dose rate was 0.01 rad(Si)/s and the high dose rate was 55 rad(Si)/s. Sample size for each cell was 5. Average upper FET Rds(on) resistance is an informational parameter and is not formally specified.

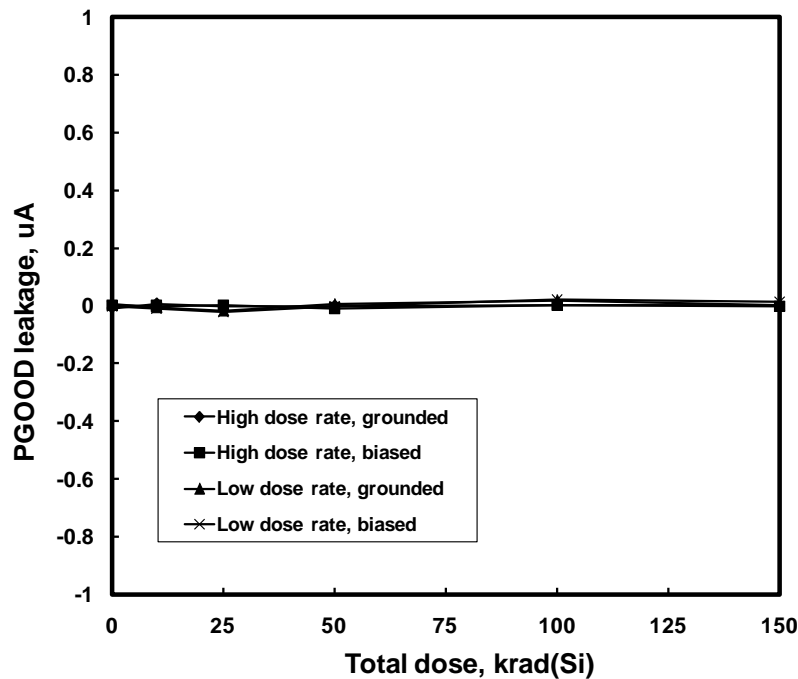


**Figure 40:** ISL70001SRH enable threshold voltage, 3V supply voltage, as a function of total dose irradiation at low and high dose rate for the unbiased (all pins grounded) and the biased (per Figure 2) cases. The low dose rate was 0.01 rad(Si)/s and the high dose rate was 55 rad(Si)/s. Sample size for each cell was 5. The SMD limit is 0.56 - 0.64V post-irradiation.

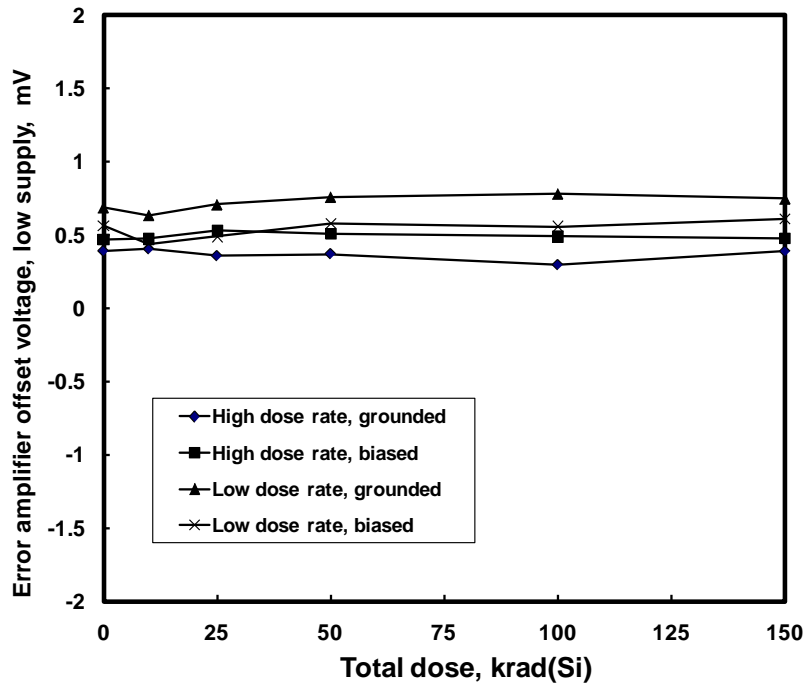




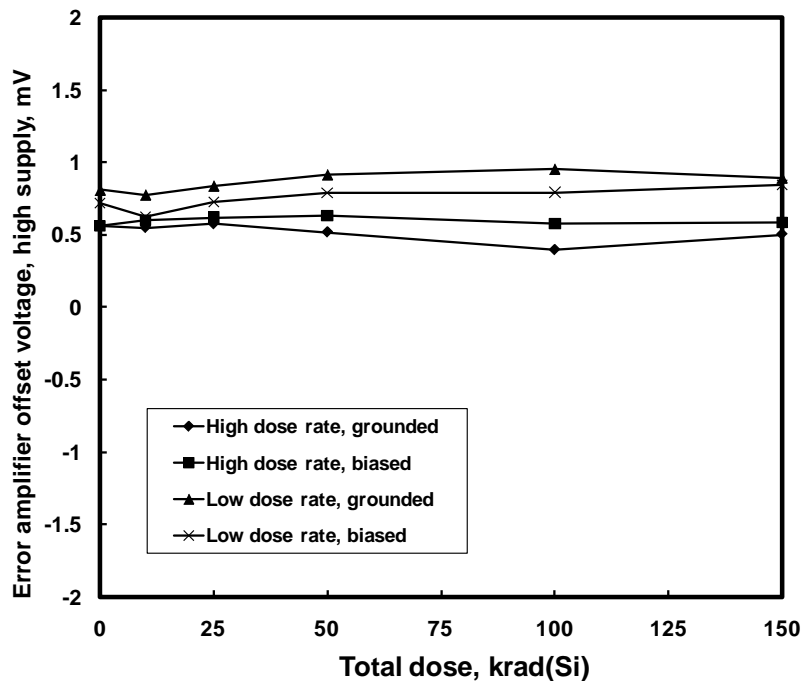
**Figure 41:** ISL70001SRH enable threshold voltage, 5.5V supply voltage, as a function of total dose irradiation at low and high dose rate for the unbiased (all pins grounded) and the biased (per Figure 2) cases. The low dose rate was 0.01 rad(Si)/s and the high dose rate was 55 rad(Si)/s. Sample size for each cell was 5. The SMD limit is 0.56 - 0.64V post-irradiation.



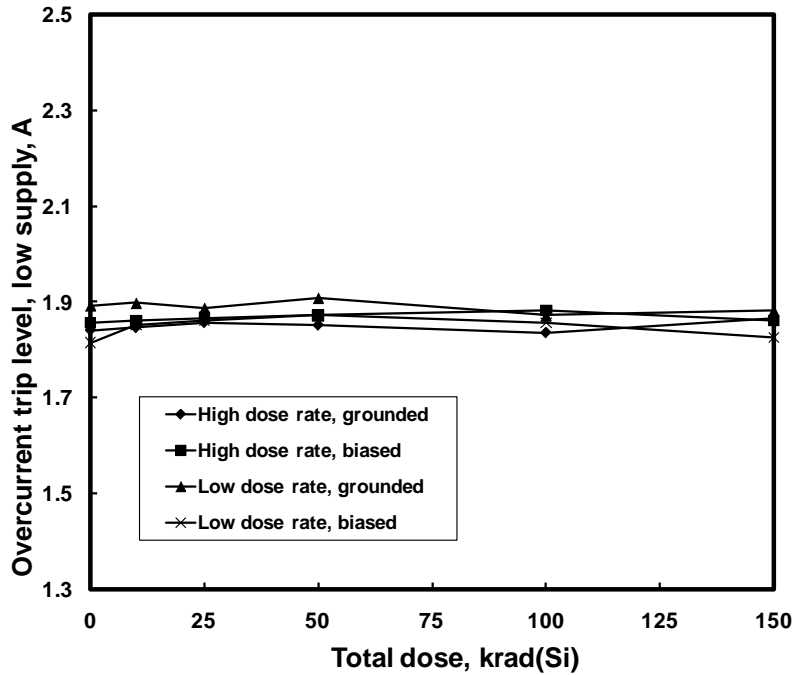
**Figure 42:** ISL70001SRH PGOOD input leakage current as a function of total dose irradiation at low and high dose rate for the unbiased (all pins grounded) and the biased (per Figure 2) cases. The low dose rate was 0.01 rad(Si)/s and the high dose rate was 55 rad(Si)/s. Sample size for each cell was 5. The SMD limit is 1 $\mu$ A maximum post-irradiation.



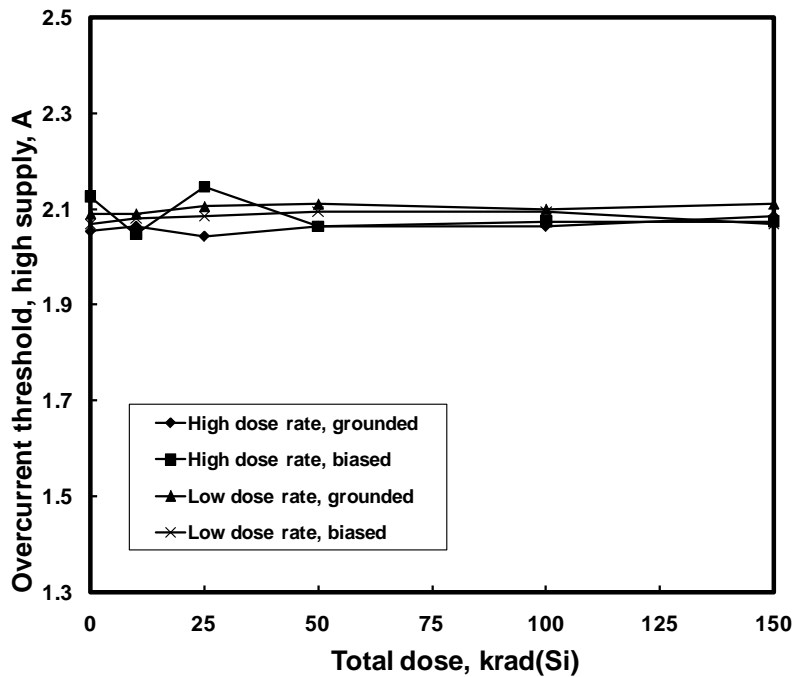
**Figure 43:** ISL70001SRH error amplifier offset voltage (low supply) as a function of total dose irradiation at low and high dose rate for the unbiased (all pins grounded) and the biased (per Figure 2) cases. The low dose rate was 0.01 rad(Si)/s and the high dose rate was 55 rad(Si)/s. Sample size for each cell was 5. Error amplifier offset voltage is an informational parameter and is not formally specified.



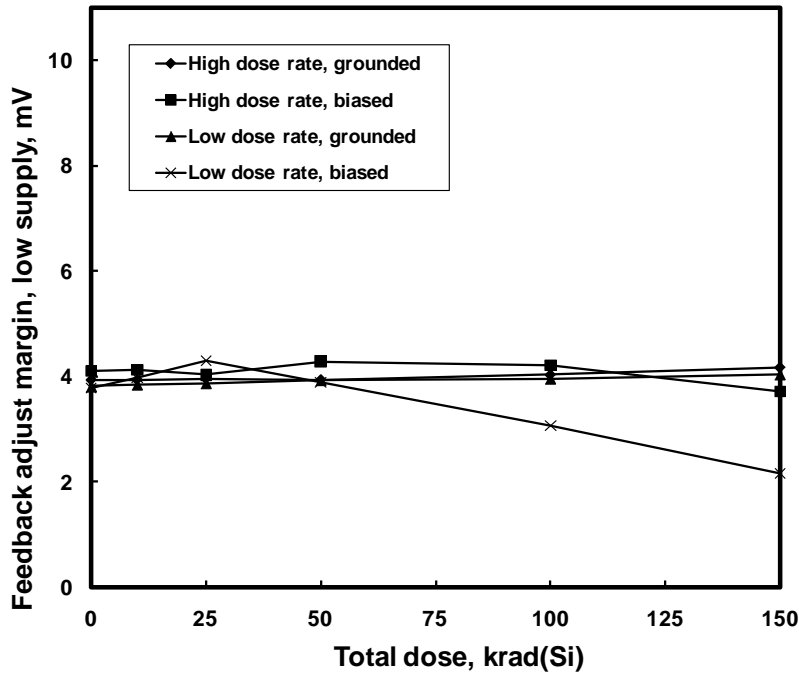
**Figure 44:** ISL70001SRH error amplifier offset voltage (high supply) as a function of total dose irradiation at low and high dose rate for the unbiased (all pins grounded) and the biased (per Figure 2) cases. The low dose rate was 0.01 rad(Si)/s and the high dose rate was 55 rad(Si)/s. Sample size for each cell was 5. Error amplifier offset voltage is an informational parameter and is not formally specified.



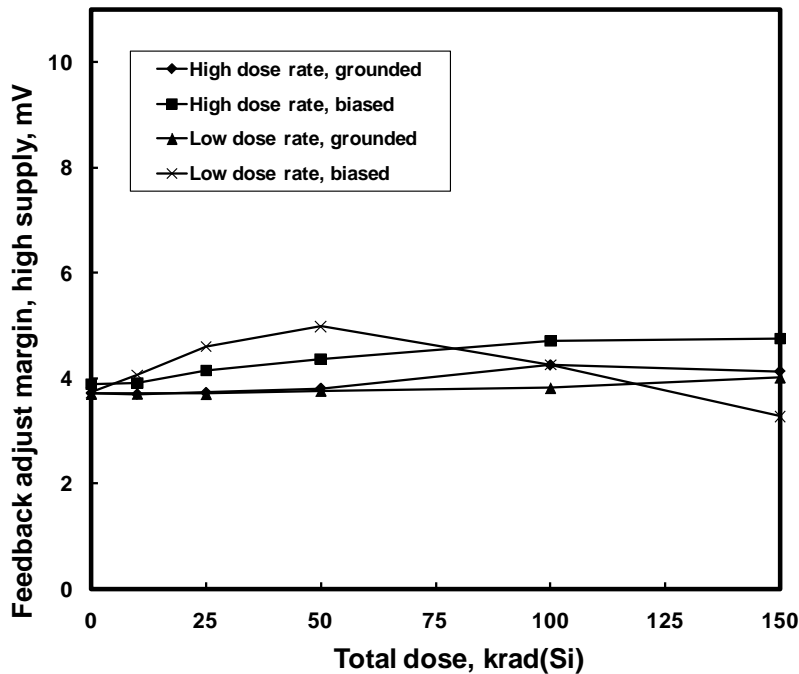
**Figure 45:** ISL70001SRH overcurrent limit threshold (low supply) as a function of total dose irradiation at low and high dose rate for the unbiased (all pins grounded) and the biased (per Figure 2) cases. The low dose rate was 0.01 rad(Si)/s and the high dose rate was 55 rad(Si)/s. Sample size for each cell was 5. The SMD limits are 1.3 – 2.5A post-irradiation.



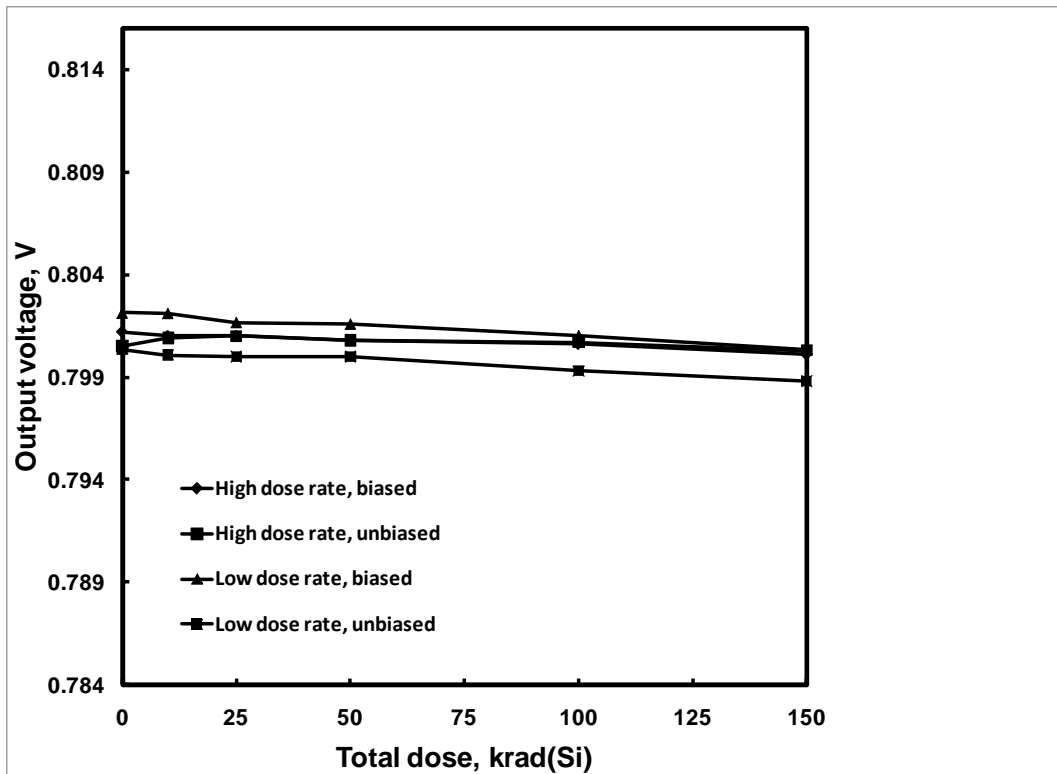
**Figure 46:** ISL70001SRH overcurrent limit threshold (high supply) as a function of total dose irradiation at low and high dose rate for the unbiased (all pins grounded) and the biased (per Figure 2) cases. The low dose rate was 0.01 rad(Si)/s and the high dose rate was 55 rad(Si)/s. Sample size for each cell was 5. The SMD limits are 1.3 – 2.5A post-irradiation.



**Figure 47:** ISL70001SRH feedback adjust margin (low supply) as a function of total dose irradiation at low and high dose rate for the unbiased (all pins grounded) and the biased (per Figure 2) cases. The low dose rate was 0.01 rad(Si)/s and the high dose rate was 55 rad(Si)/s. Sample size for each cell was 5. Feedback adjust margin is an informational parameter and is informally specified at 11mV maximum.



**Figure 48:** ISL70001SRH feedback adjust margin (high supply) as a function of total dose irradiation at low and high dose rate for the unbiased (all pins grounded) and the biased (per Figure 2) cases. The low dose rate was 0.01 rad(Si)/s and the high dose rate was 55 rad(Si)/s. Sample size for each cell was 5. Feedback adjust margin is an informational parameter and is informally specified at 11mV maximum.



**Figure 49:** ISL70001SRH output voltage (low supply) as a function of total dose irradiation at low and high dose rate for the unbiased (all pins grounded) and the biased (per Figure 2) cases. The low dose rate was 0.01 rad(Si)/s and the high dose rate was 55 rad(Si)/s. Sample size for each cell was 5. The SMD limits are +/-2% post-irradiation, which equals 0.784 to 0.816V.

## 6: Conclusion

This document reports the results of total dose testing of the ISL70001SRH hardened point of load (POL) regulator. Parts were tested at low and high dose rate under biased and unbiased conditions as outlined in MIL-STD-883 Test Method 1019.7, to a maximum total dose of 150 krad(Si) at both dose rates.

ATE characterization testing at downpoints showed no rejects to the SMD Group A limits. Variables data for selected parameters is presented in Figures 3 through 49.

As a determinant of low dose rate sensitivity, MIL-STD-883 Test Method 1019.7 specifies that a delta\_parameter calculation be performed for any parameters that exceed the Group A limits. These calculations were not required as there were no rejects against the Group A limits. Accordingly, the part is considered ELDRS-free up to the 100 krad(Si) total dose rating specified in the SMD. It should be noted that the ISL70001SRH pre- and post- irradiation limits are identical.

Similarly, no differences between biased and unbiased irradiation were noted, and the part is not considered bias sensitive.

## 7: Appendices

7.1: Reported parameters. Note all limits are over the full military temperature range of -55 to +125 degrees Centigrade.

Figure	Parameter	Limit, low	Limit, high	Units	Notes
3	Reference voltage	594	606	mV	
4	Bandgap voltage	none	none	mV	Information only
5	Enable LOW leakage	-3	3	μA	
6	Enable HIGH leakage	-3	3	μA	
7	Enable sink current, 3V Vdd	6.4	16.6	μA	
8	Enable sink current, 5V Vdd	6.4	16.6	μA	
9	FB pin bias current	-1	1	μA	
10	LX1 LOW leakage	-1		μA	
11	LX2 LOW leakage	-1		μA	
12	LX3 LOW leakage	-1		μA	
13	LX4 LOW leakage	-1		μA	
14	LX5 LOW leakage	-1		μA	
15	LX6 LOW leakage	-1		μA	
16	LX1 HIGH leakage		15	μA	
17	LX2 HIGH leakage		15	μA	
18	LX3 HIGH leakage		15	μA	
19	LX4 HIGH leakage		15	μA	
20	LX5 HIGH leakage		15	μA	
21	LX6 HIGH leakage		15	μA	
22	Oscillator frequency	850	1150	KHz	
23	Operating current, VDD=3.6V		45	mA	
24	Operating current, VDD=4.15V	none	none	mA	Information only
25	Operating current, VDD=5.5V		65	mA	
26	Lower FET Ron, ch1	108	184	mohm	
27	Lower FET Ron, ch2	108	184	mohm	
28	Lower FET Ron, ch3	108	184	mohm	
29	Lower FET Ron, ch4	108	184	mohm	
30	Lower FET Ron, ch5	108	184	mohm	
31	Lower FET Ron, ch6	108	184	mohm	
32	Lower FET average Ron	none	none	mohm	Information only
33	Upper FET Ron, ch1	153	277	mohm	
34	Upper FET Ron, ch2	153	277	mohm	
35	Upper FET Ron, ch3	153	277	mohm	
36	Upper FET Ron, ch4	153	277	mohm	
37	Upper FET Ron, ch5	153	277	mohm	
38	Upper FET Ron, ch6	153	277	mohm	
39	Upper FET average Ron	none	none	mohm	Information only
40	Enable threshold voltage, VDD=3V	0.56	0.64	V	

<b>41</b>	Enable threshold voltage, VDD=5.5V	0.56	0.64	V	
<b>42</b>	PGOOD input leakage		1	μA	
<b>43</b>	Error amplifier offset voltage, VDD=3V	none	none	mV	Information only
<b>44</b>	Error amplifier offset voltage, VDD=5.5V	none	none	mV	Information only
<b>45</b>	Overcurrent limit, VDD=3V	1.3	2.5	A	
<b>46</b>	Overcurrent limit, VDD=5.5V	1.3	2.5	A	
<b>47</b>	Feedback adjust margin, VDD=3V	none	none	mV	Information only
<b>48</b>	Feedback adjust margin, VDD=5.5V	none	none	mV	Information only
<b>49</b>	Output voltage, VDD=3V	0.784	0.816	V	For 800mV VOUT set point

Note 1: Limits are taken from Standard Microcircuit Drawing (SMD) 5962-09225.

## 8: Document revision history

Revision	Date	Pages	Comments
0	23 March 2010	All	Original issue
1	31 March 2010	29,30,31	Added table, clarified conclusion
2	10 June 2010	All	Added 150krad low dose rate data
3	16 August 2011	2	Added definition of ISL70001SEH