



Total dose testing of the HS-565BRH digital to analog converter

Nick van Vonno
Intersil Corporation

Revision 0
August 2010

Table of Contents

- 1. Introduction**
- 2. Reference Documents**
- 3. Part Description**
- 4. Test Description**
 - 4.1 Irradiation facility**
 - 4.2 Test fixturing**
 - 4.3 Characterization equipment and procedures**
 - 4.4 Experimental Matrix**
 - 4.5 Downpoints**
- 5 Results**
 - 5.1 Test results**
 - 5.2 Variables data**
- 6 Discussion**
- 7 Conclusion**
- 8 Appendices**
- 9 Document revision history**

1. Introduction

This report summarizes the results of a low and high dose rate total dose test of the HS-565BRH digital to analog converter. The test was conducted in order to determine the sensitivity of the part to the total dose environment and to low dose rate irradiation in particular.

2. Reference Documents

- MIL-STD-883G test method 1019.7
- MIL-PRF-38535 (QML)
- HS-565BRH data sheet, Intersil document FN4607.3
- DSCC Standard Microcircuit Drawing (SMD) 5962- 96755

3: Part Description

The HS-565BRH is a hardened 12-bit analog to digital converter (DAC). The part replaces the HS-565ARH which is obsolete and no longer available. The monolithic chip includes a precision voltage reference, a thin-film resistor R-2R ladder network, a reference control amplifier and twelve high-speed bipolar current switches. The part is implemented in a dielectrically isolated process which provides latchup-free operation and minimizes parasitic capacitance and leakage currents. Ground currents are also minimized, which produces a low and constant current through the ground terminal, reducing errors due to code-dependent ground currents. The HS-565BRH is laser trimmed at the die level for a maximum integral nonlinearity error of +/-0.25LSB at room temperature. In addition, the low noise on-chip buried Zener diode reference is trimmed both for absolute value and minimum temperature coefficient.

Detailed specifications for the part are contained in SMD 5962-96755. The Intersil Web site contains a link for downloading this drawing.

- QML Qualified per MIL-PRF-38535 requirements
- 100 krad (Si) total dose rating
- DAC and reference on a single chip
- Pin compatible with AD-565A and HI-565A
- Settles to 0.50 LSB in 500ns maximum
- Monotonicity guaranteed over temperature
- 0.50 LSB Maximum nonlinearity guaranteed over temperature
- Low gain drift 50ppm/°C (maximum, DAC plus reference)
- ±0.75 LSB accuracy guaranteed over temperature

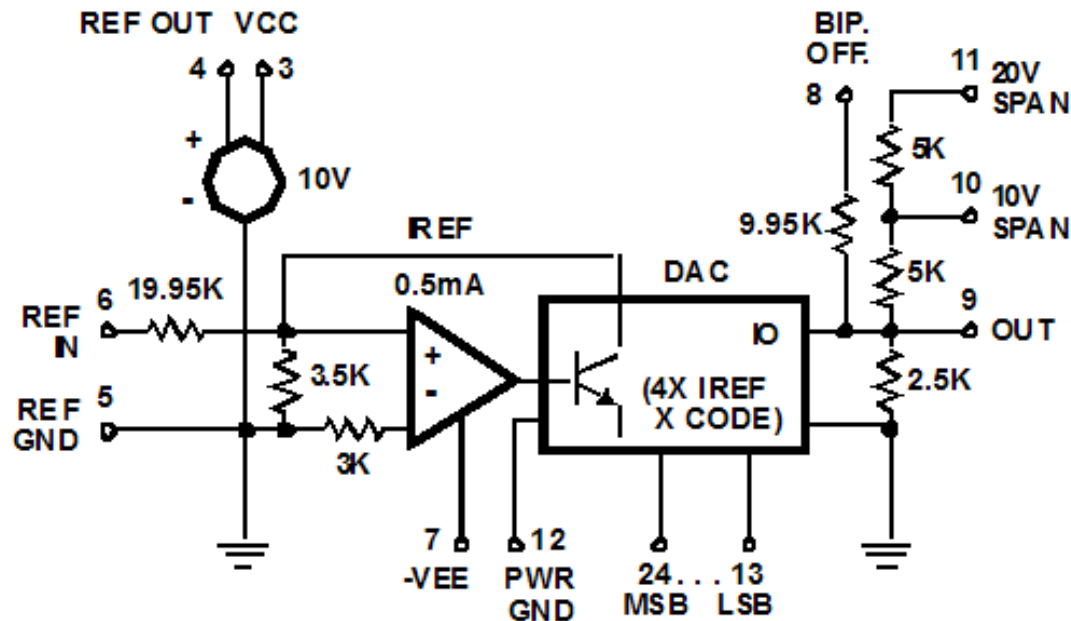

Figure 1: HS-565BRH block diagram.

4: Test Description

4.1 Irradiation Facilities

High dose rate testing of the HS-565BRH was performed using a Gammacell 220 ⁶⁰Co irradiator located in the Palm Bay, Florida Intersil facility. Low dose rate testing was performed on a subcontract basis at White Sands Missile Range (White Sands, NM). The use of an off-site irradiator necessitated detailed precautions to control the packing temperature during shipment to avoid annealing effects. This was accomplished by the use of Styrofoam shipping containers, Gelpack cold packs and miniaturized strip chart recorders to provide a continuous temperature monitor.

The high dose rate irradiations were done at 55rad(Si)/s and the low dose rate work was performed at .010rad(Si)/s, both per MIL-STD-883 Method 1019.7. Dosimetry for both tests was performed using Far West Technology radiochromic dosimeters and on-site readout equipment.

4.2 Test Fixturing

Figure 2 shows the configuration used for biased irradiation in conformance with Standard Microcircuit Drawing (SMD) 5962-96755. This configuration was used for both low and high dose rate irradiation. The unbiased irradiation was carried out with all pins grounded.

MKT. PART #: HI1-565ARH

MASK #: 12531/38631

FIGURE #: 133

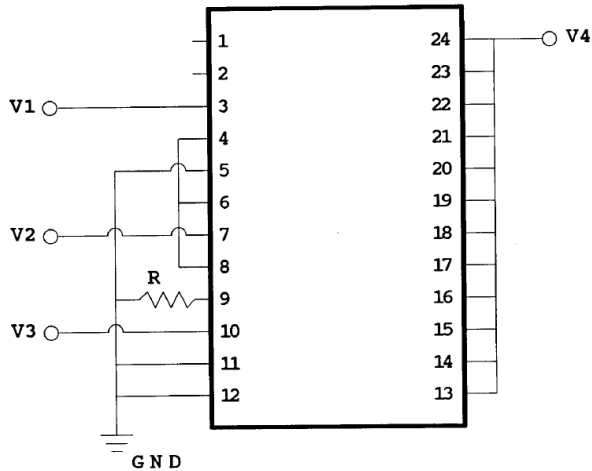

V1 = +15 volts

V2 = -15 volts

V3 = +10 volts

V4 = +5 volts

R = 50 ohms

Title:
RAD HARD FIGURE

Specification Type: DOCS

Specification Number :233032-001-133

Issue :0

Page :1 of 1

These Drawings and Specifications are the Property of Intersil Corporation and shall not be used, reproduced or copied without Written Permission

Figure 2: Irradiation bias configuration for the HS-565BRH per Standard Microcircuit Drawing (SMD) 5962-96755, as used for both low and high dose rate biased irradiation.

4.3 Characterization equipment and procedures

All electrical testing was performed outside the irradiator using the production automated test equipment (ATE) with datalogging of all parameters at each downpoint. Downpoint electrical testing was performed at room temperature.

4.5 Experimental matrix

The experimental matrix consisted of four cells: five samples irradiated at high dose rate with all pins grounded, five samples irradiated at high dose rate under bias, five samples irradiated at low dose rate with all pins grounded and five samples irradiated at low dose rate under bias. One control unit was used. This experimental approach was in close compliance with the guidelines of MIL-STD-883 Test Method 1019.7 for diagnostic ELDRS testing.

Samples of the HS-565BRH were drawn from wafer 12 of production lot DPE8AK and were packaged in the standard hermetic 24-pin ceramic flatpack (CFP) production package. Samples were processed through the standard burnin cycle before irradiation, as required by MIL-STD-883, and were screened to the SMD 5962-96755 limits at room, low and high temperatures before the test.

4.6 Downpoints

Downpoints for the tests were zero, 50krad(Si), 100krad(Si) and 150krad(Si) for the high dose rate test and zero, 10krad(Si), 25krad(Si), 50krad(Si), 100krad(Si), 125krad(Si) and 150krad(Si) for the low dose rate test.

5: Results

5.1 Test results

The low and high dose rate tests of the HS-565BRH are complete and showed no reject devices after irradiation to 150krad(Si) at low and high dose rate), screening to the SMD post-irradiation limits.

5.2 Variables data

The plots in Figures 3 through 26 show data at all downpoints. The plots show the median of key parameters as a function of total dose for each of the four irradiation conditions. We chose to plot the median (as opposed to for example mean and standard deviation) because of the relatively small sample sizes involved. All parts showed good stability over irradiation, with no observed low dose rate sensitivity. Appendix 1 summarizes key parameters of the device that have been plotted in Figures 3 – 26. Terminology is in accordance with the applicable SMD 5962-96755. Refer to the Discussion section for further analysis.

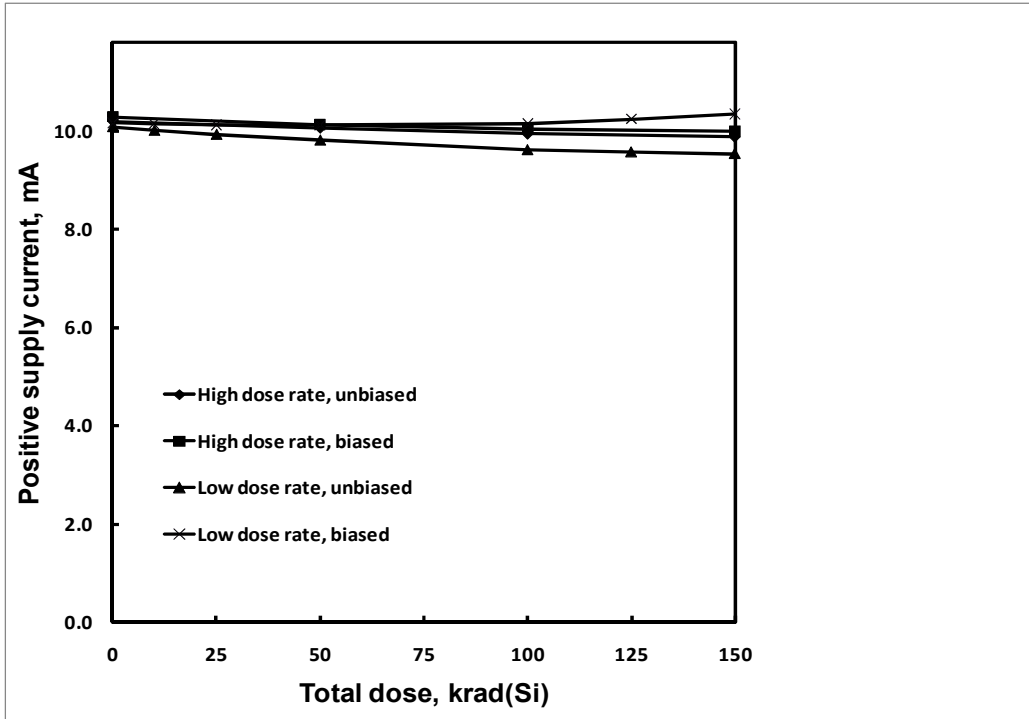

Figure 3: HS-565BRH positive power supply current as a function of total dose irradiation at low and high dose rate. The low dose rate was 0.01rad(Si)/s and the high dose rate was 55rad(Si)/s. Sample size for each cell was 5. The SMD limit for this parameter is 11.8mA maximum post-irradiation.

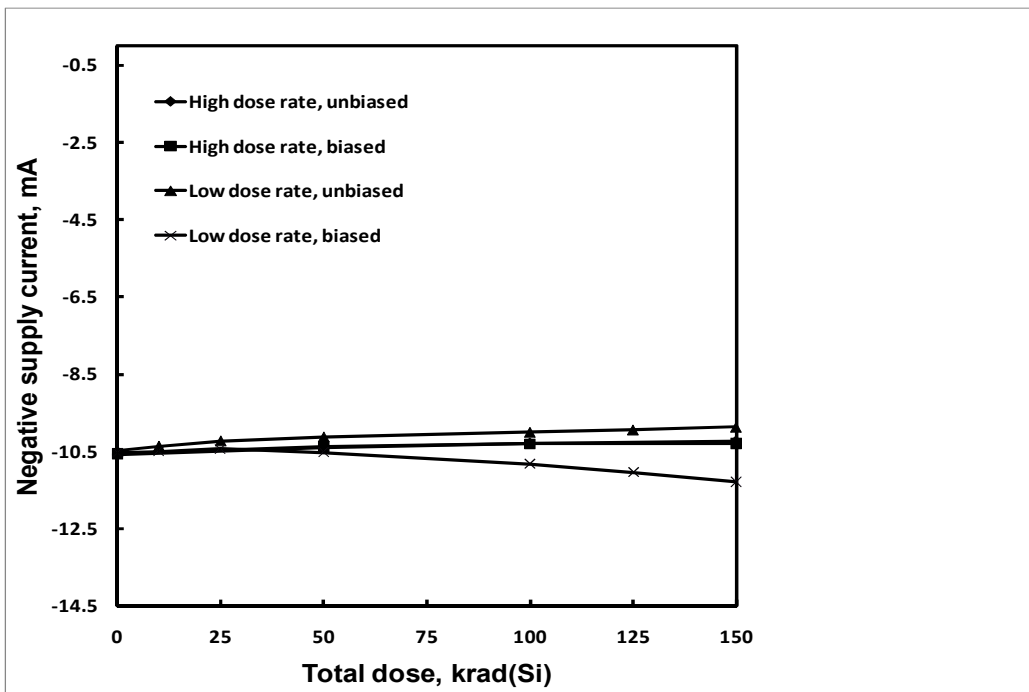

Figure 4: HS-565BRH negative power supply current as a function of total dose irradiation at low and high dose rate. The low dose rate was 0.01rad(Si)/s and the high dose rate was 55rad(Si)/s. Sample size for each cell was 5. The SMD limit for this parameter is -14.5mA maximum post-irradiation.

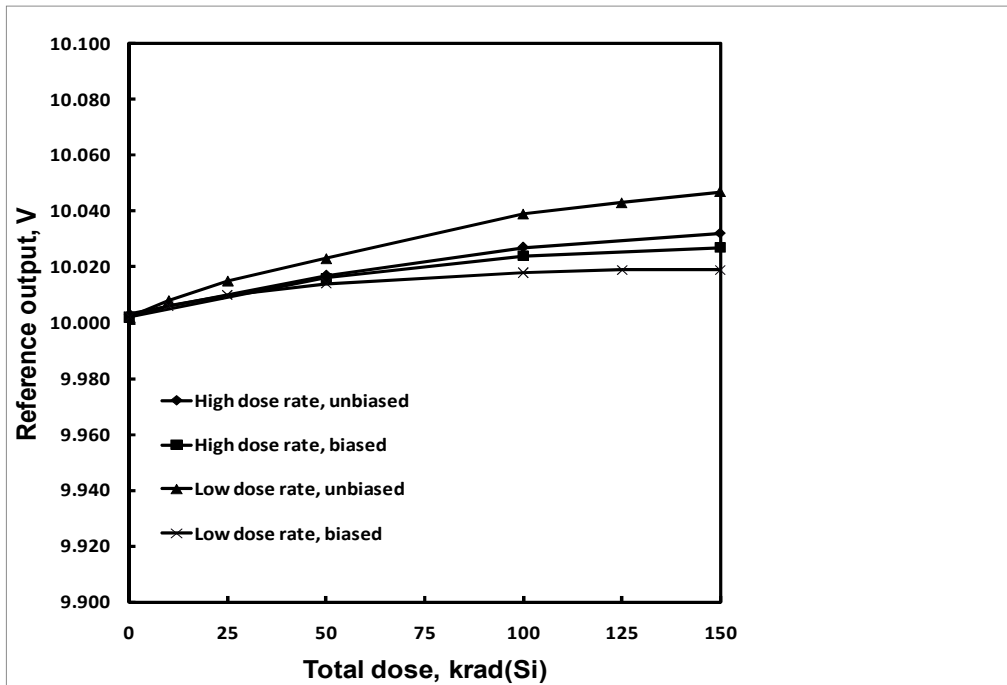

Figure 5: HS-565BRH voltage reference output voltage as a function of total dose irradiation at low and high dose rate. The low dose rate was 0.01rad(Si)/s and the high dose rate was 55rad(Si)/s. Sample size for each cell was 5. The SMD limits for this parameter are 9.9V to 10.1V post-irradiation.

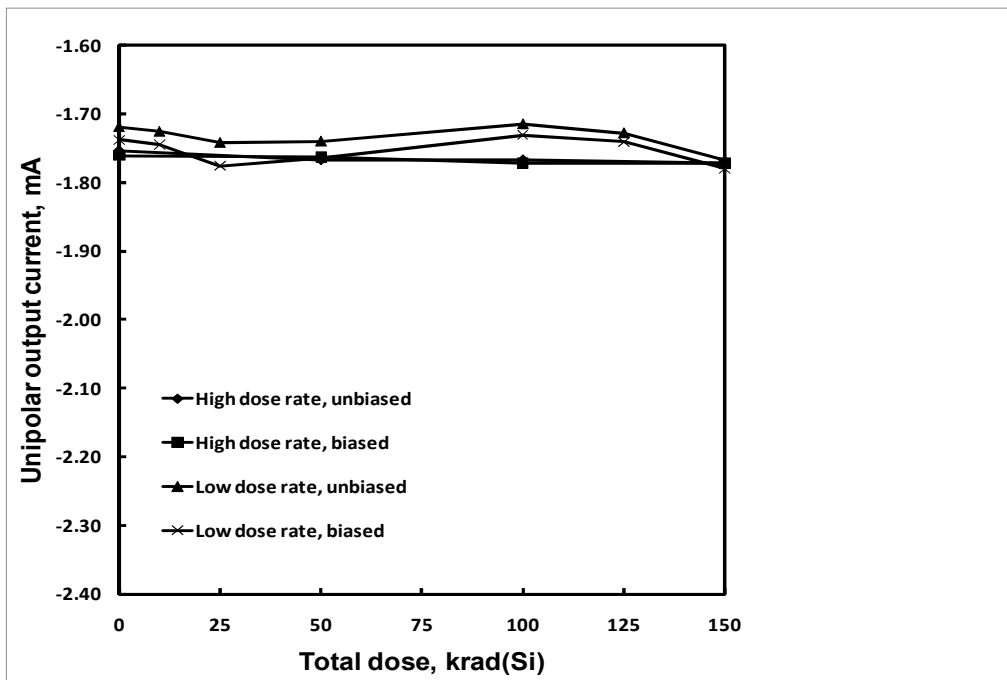

Figure 6: HS-565BRH unipolar output current as a function of total dose irradiation at low and high dose rate. The low dose rate was 0.01rad(Si)/s and the high dose rate was 55rad(Si)/s. Sample size for each cell was 5. The SMD limits for this parameter are -2.4mA to -1.6mA post-irradiation.

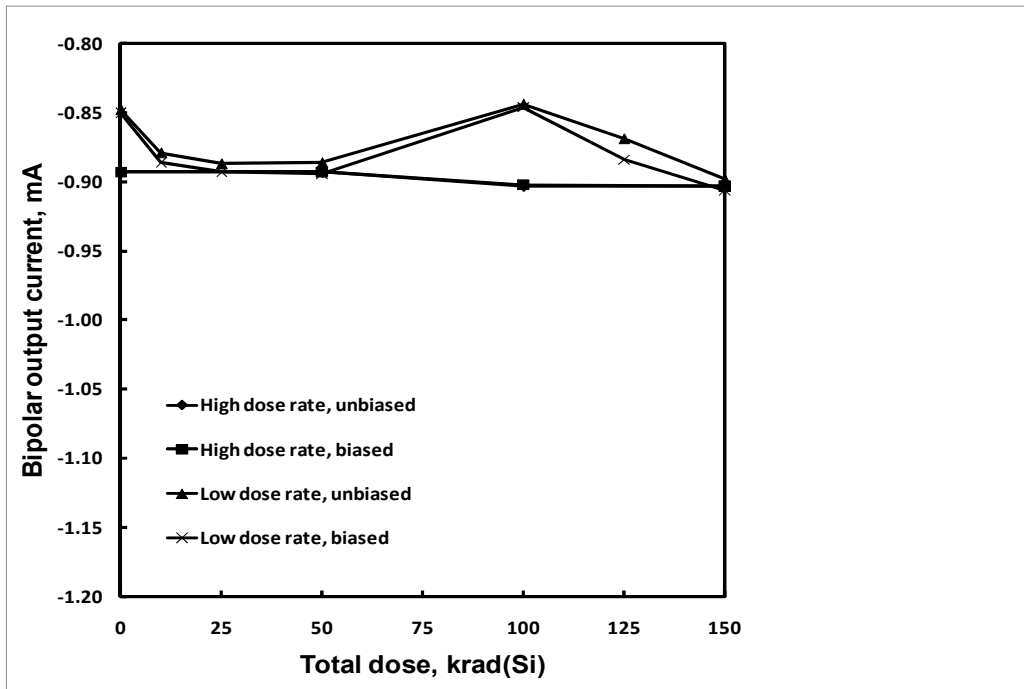

Figure 7: HS-565BRH bipolar output current as a function of total dose irradiation at low and high dose rate. The low dose rate was 0.01rad(Si)/s and the high dose rate was 55rad(Si)/s. Sample size for each cell was 5. The SMD limits for this parameter are -1.2mA to -0.8mA post-irradiation.

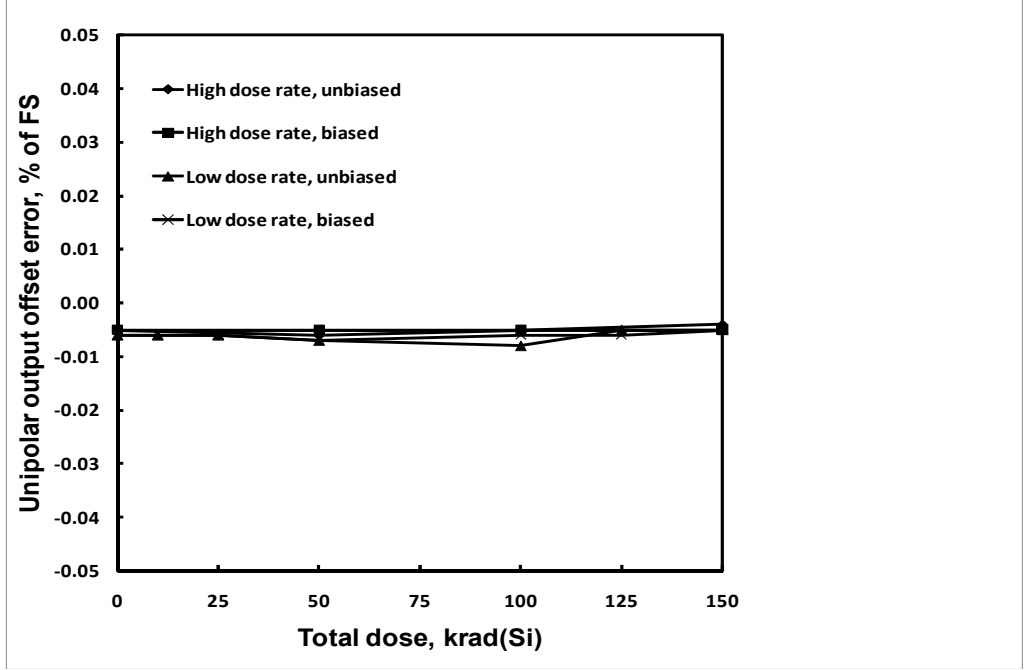

Figure 8: HS-565BRH unipolar output offset error as a function of total dose irradiation at low and high dose rate. The low dose rate was 0.01rad(Si)/s and the high dose rate was 55rad(Si)/s. Sample size for each cell was 5. The SMD limits for this parameter are -0.05% of full scale to 0.05% of full scale post-irradiation.

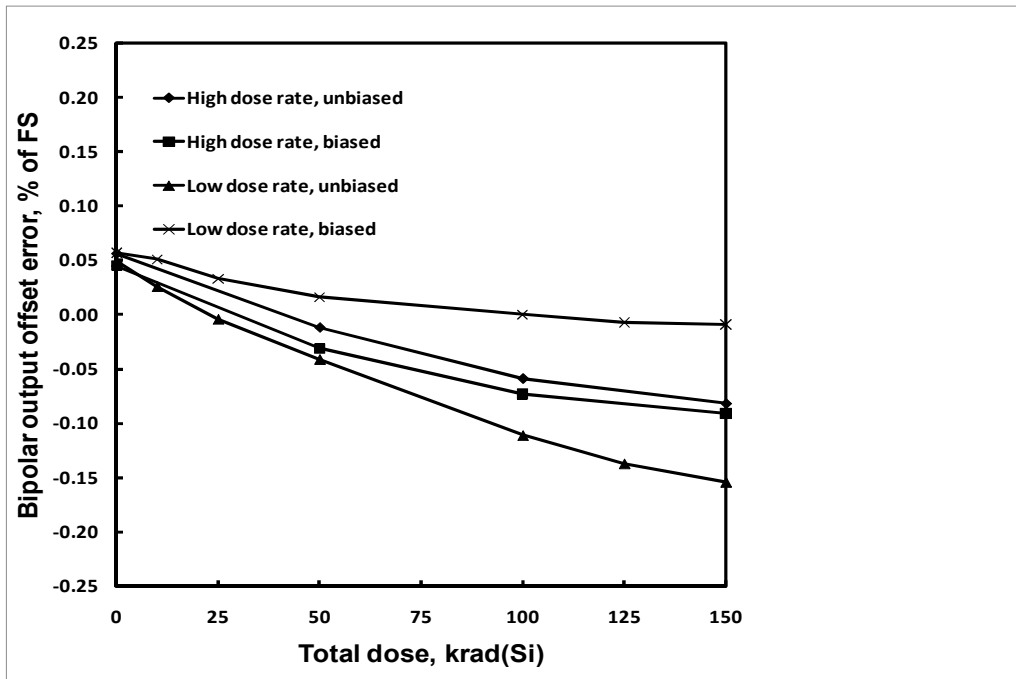

Figure 9: HS-565BRH bipolar output offset error as a function of total dose irradiation at low and high dose rate. The low dose rate was 0.01rad(Si)/s and the high dose rate was 55rad(Si)/s. Sample size for each cell was 5. The SMD limits for this parameter are -0.25% of full scale to 0.25% of full scale post-irradiation.

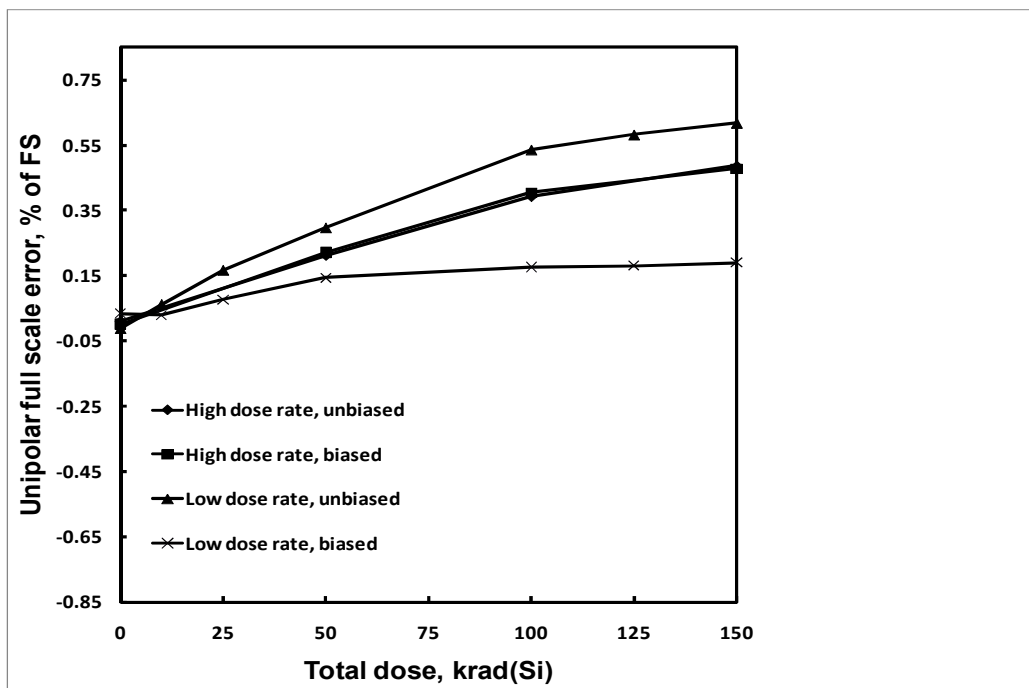

Figure 10: HS-565BRH unipolar full scale error as a function of total dose irradiation at low and high dose rate. The low dose rate was 0.01rad(Si)/s and the high dose rate was 55rad(Si)/s. Sample size for each cell was 5. The SMD limits for this parameter are -0.85% of full scale to 0.85% of full scale post-irradiation.

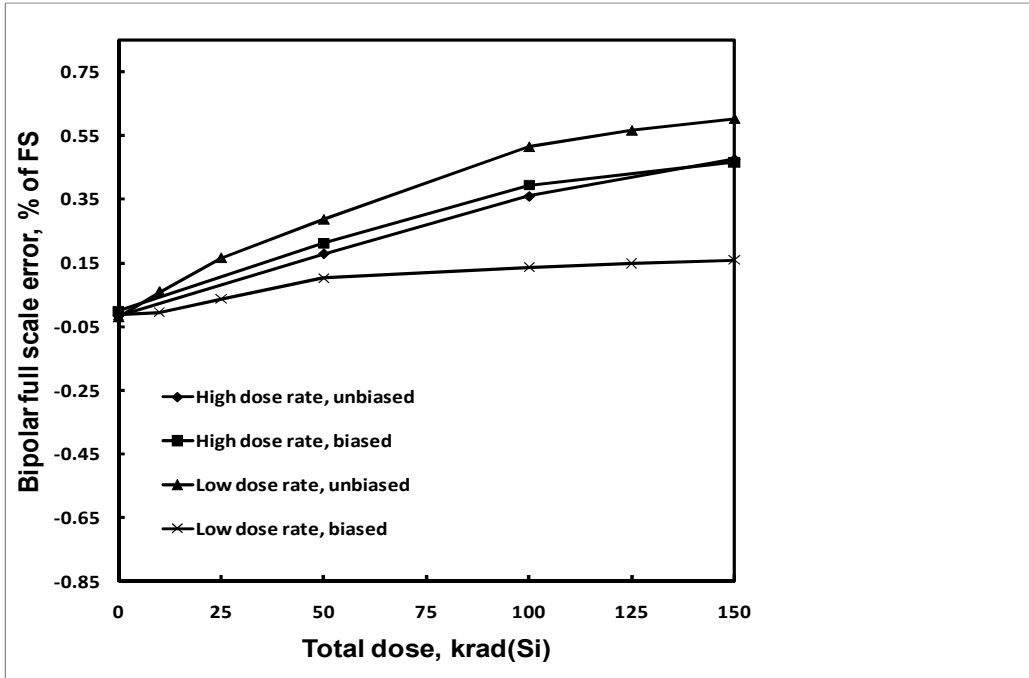

Figure 11: HS-565BRH bipolar full scale error as a function of total dose irradiation at low and high dose rate. The low dose rate was 0.01rad(Si)/s and the high dose rate was 55rad(Si)/s. The SMD limits for this parameter are -0.85% of full scale to 0.85% of full scale post-irradiation.

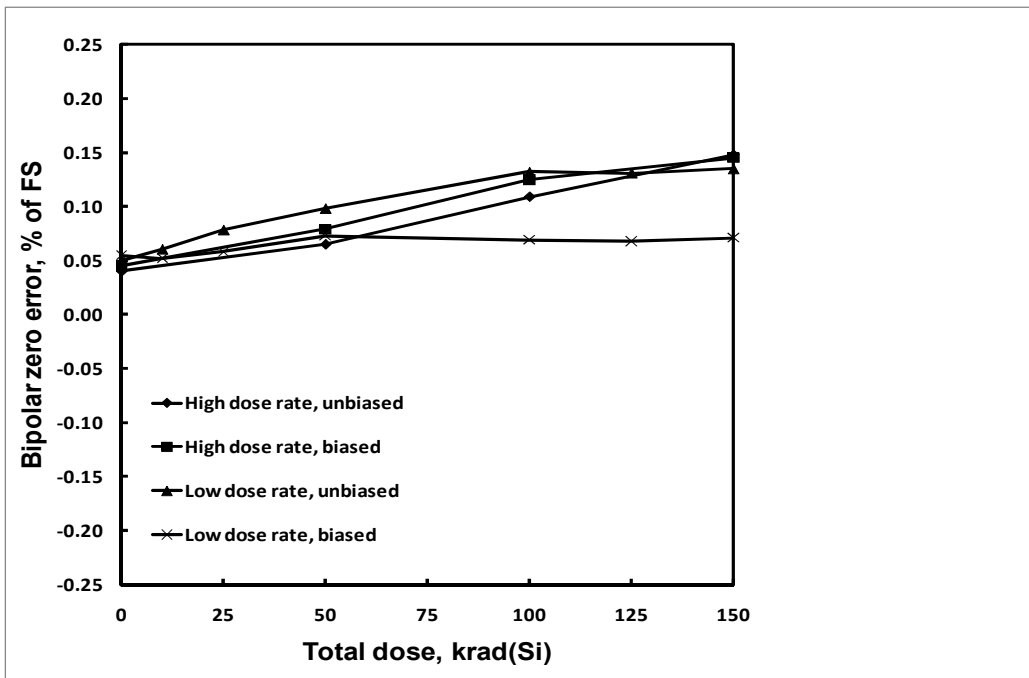

Figure 12: HS-565BRH bipolar zero error as a function of total dose irradiation at low dose rate of 0.01rad(Si)/s, unbiased irradiation. The SMD limits for this parameter are -0.25% of full scale to 0.25% of full scale post-irradiation.

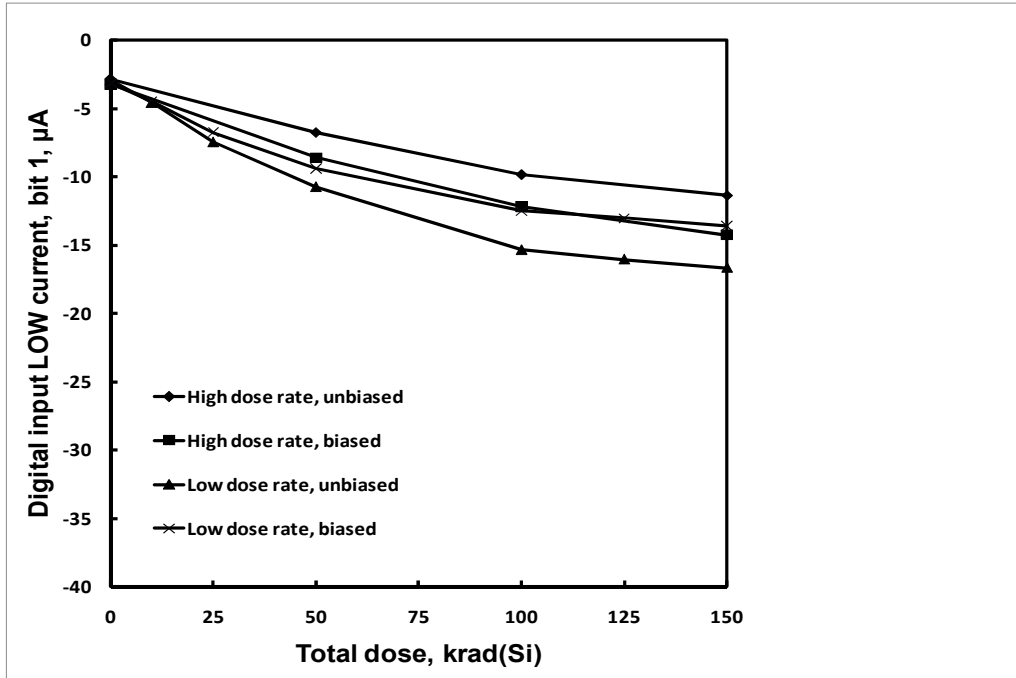

Figure 13: HS-565BRH digital input LOW current, bit 1, as a function of total dose irradiation at low dose rate of 0.01rad(Si)/s, biased irradiation. The SMD limit for this parameter is -40µA maximum post-irradiation.

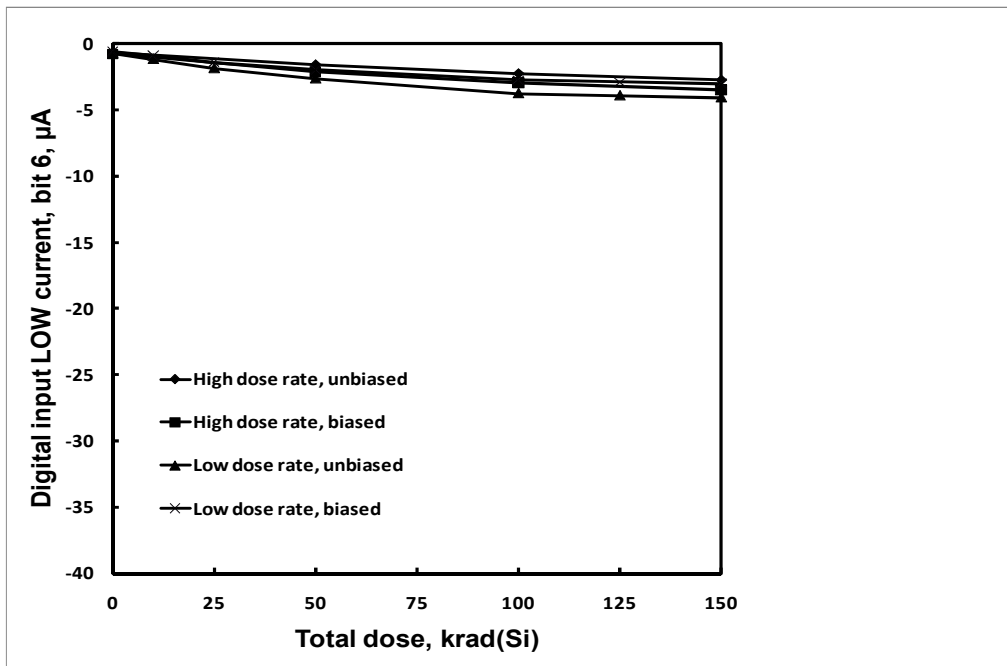

Figure 14: HS-565BRH digital input LOW current, bit 6, as a function of total dose irradiation at low dose rate of 0.01rad(Si)/s, biased irradiation. The SMD limit for this parameter is -40µA maximum post-irradiation.

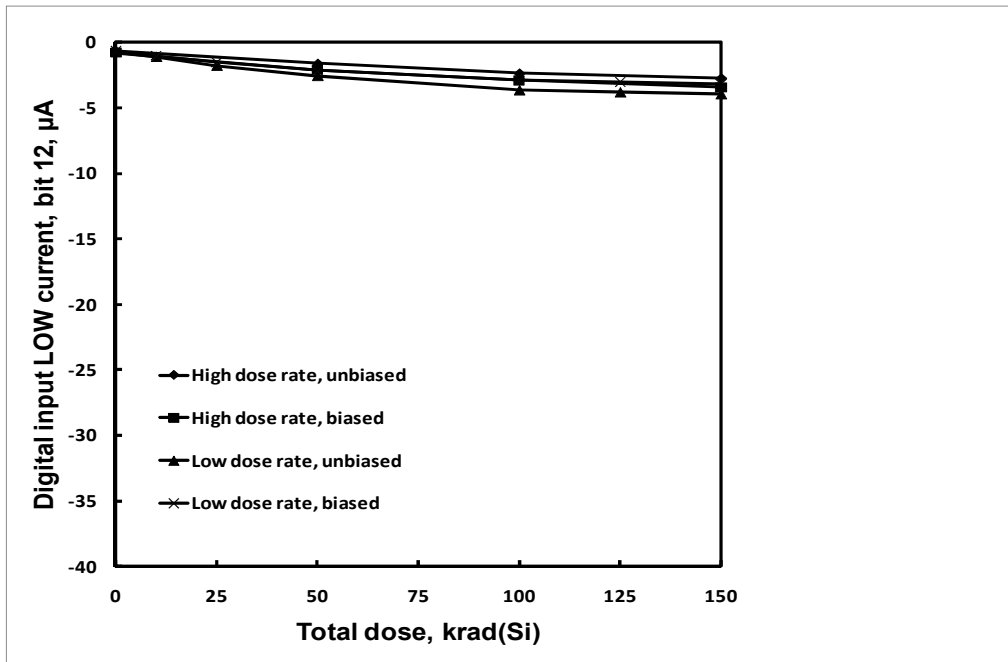

Figure 15: HS-565BRH digital input LOW current, bit 12, as a function of total dose irradiation at low dose rate of 0.01rad(Si)/s, biased irradiation. The SMD limit for this parameter is -40µA maximum post-irradiation.

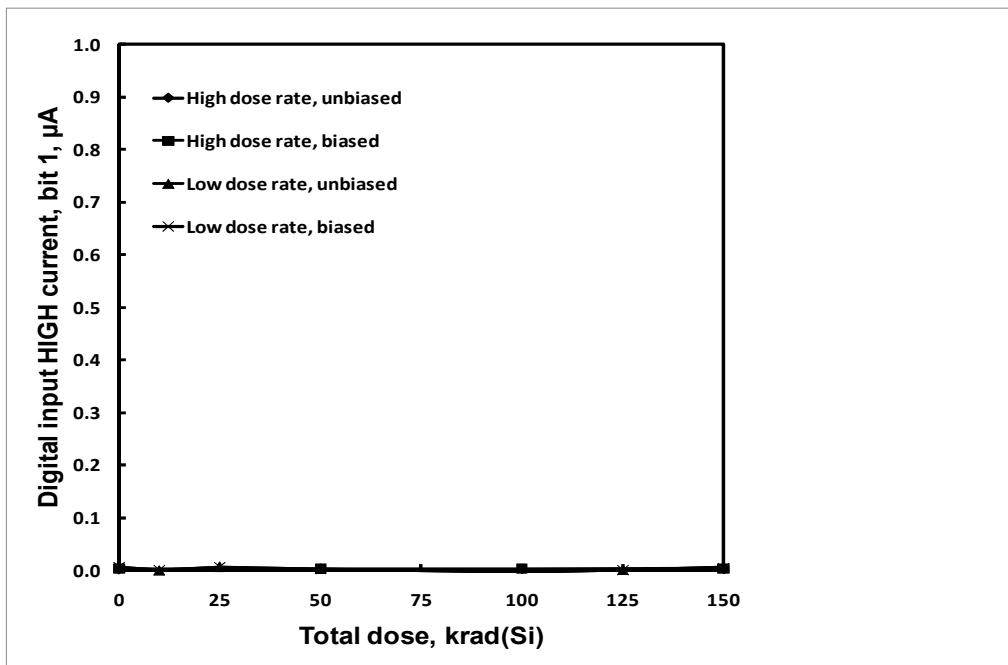

Figure 16: HS-565BRH digital input HIGH current, bit 1, as a function of total dose irradiation at low dose rate of 0.01rad(Si)/s, biased irradiation. The SMD limit for this parameter is 1µA maximum post-irradiation. All four curves are coincident with the X-axis.

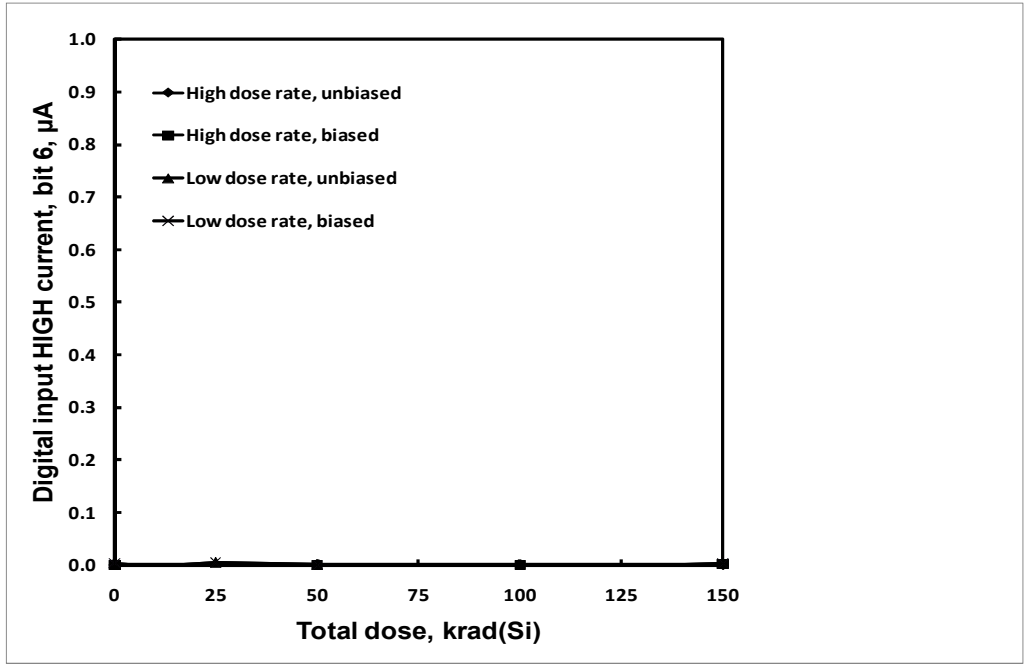

Figure 17: HS-565BRH digital input HIGH current, bit 6, as a function of total dose irradiation at low dose rate of 0.01rad(Si)/s, biased irradiation. The SMD limit for this parameter is 1µA maximum post-irradiation. All four curves are coincident with the X-axis.

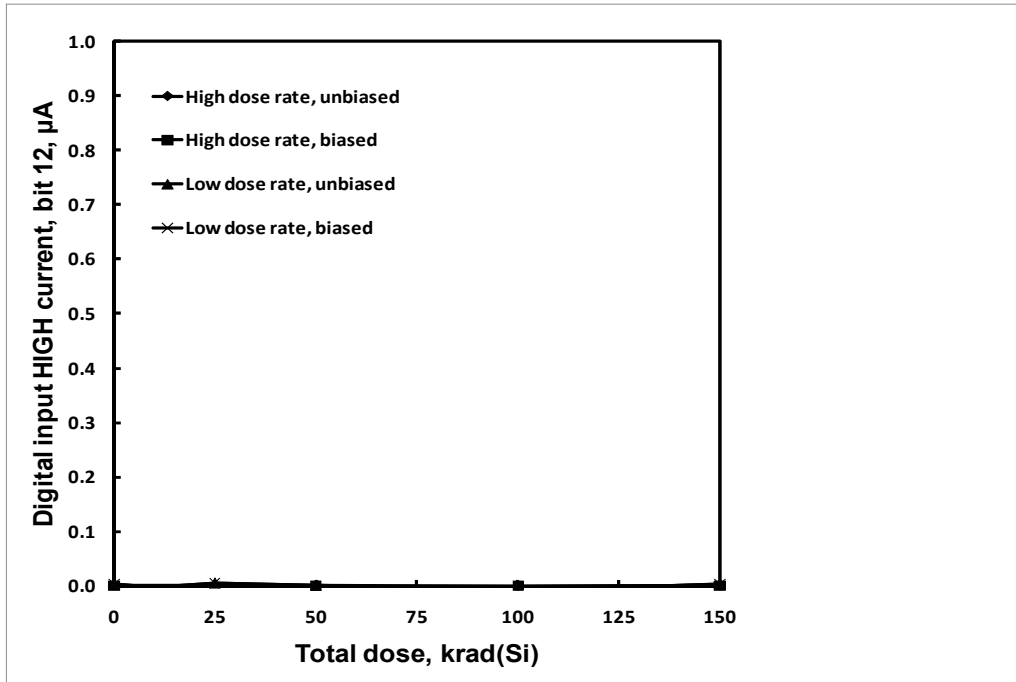

Figure 18: HS-565BRH digital input HIGH current, bit 12, as a function of total dose irradiation at low dose rate of 0.01rad(Si)/s, biased irradiation. The SMD limit for this parameter is 1µA maximum post-irradiation. All four curves are coincident with the X-axis.

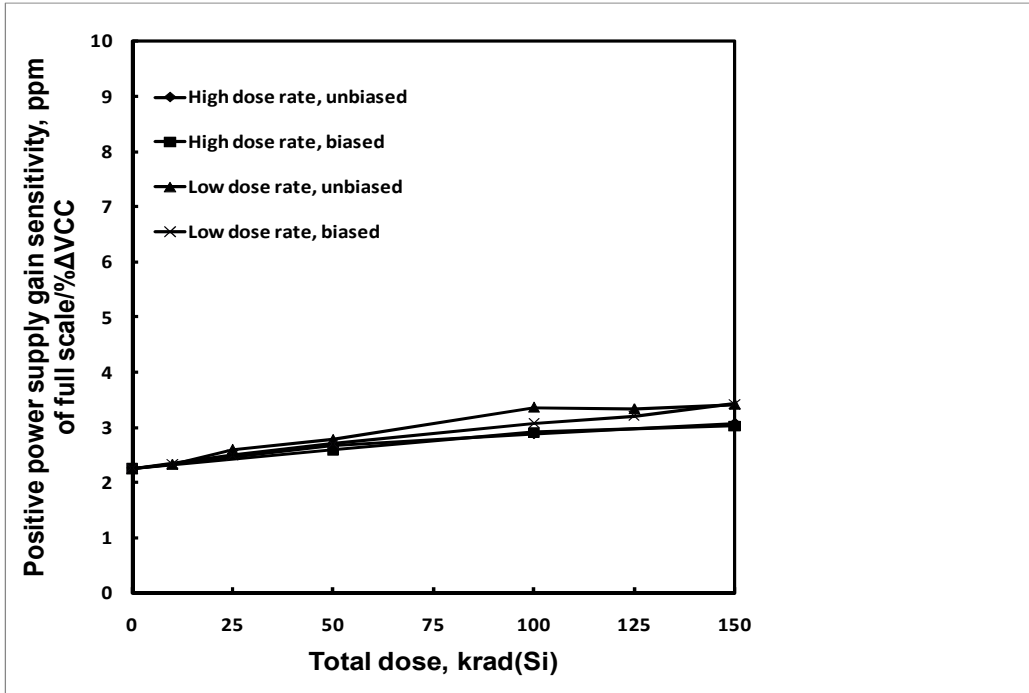

Figure 19: HS-565BRH positive power supply gain sensitivity as a function of total dose irradiation at low and high dose rate. The low dose rate was .01rad(Si)/s and the high dose rate was 55rad(Si)/s. Sample size for each cell was 5. The SMD limit for this parameter is 10 ppm of full scale/% ΔV_{CC} maximum post-irradiation.

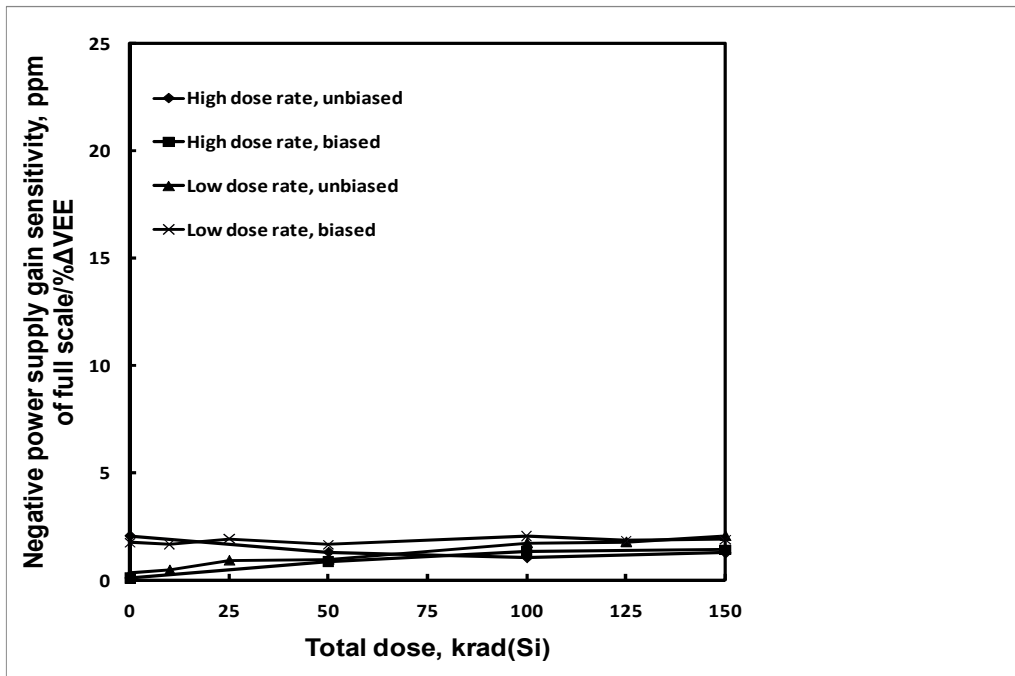

Figure 20: HS-565BRH negative power supply gain sensitivity as a function of total dose irradiation at low and high dose rate. The low dose rate was .01rad(Si)/s and the high dose rate was 55rad(Si)/s. Sample size for each cell was 5. The SMD limit for this parameter is 25 ppm of full scale/% ΔV_{CC} maximum post-irradiation.

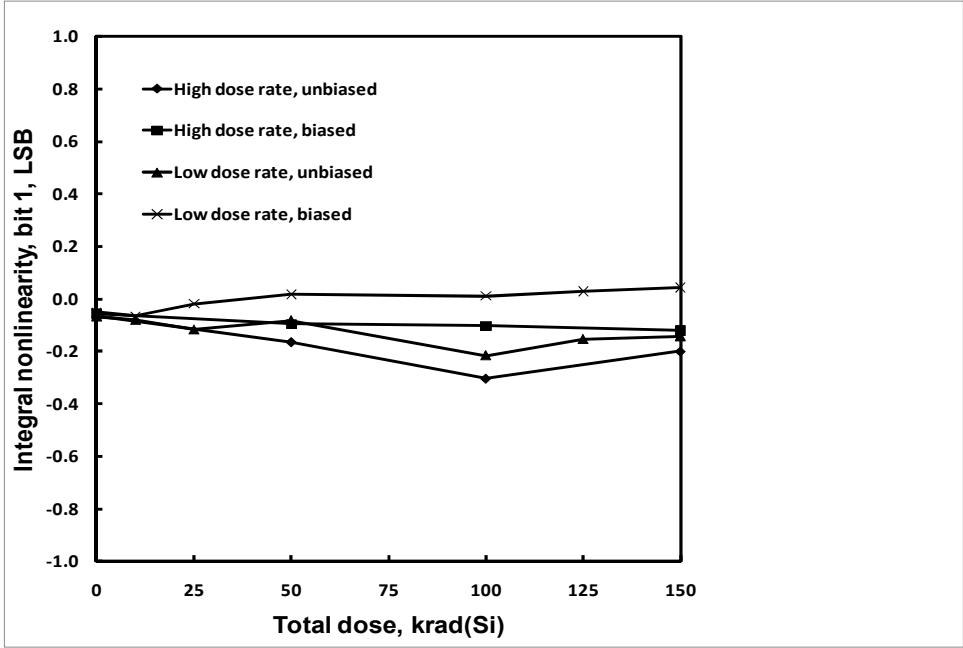

Figure 21: HS-565BRH integral nonlinearity, bit 1, as a function of total dose irradiation at low and high dose rate. The low dose rate was .01rad(Si)/s and the high dose rate was 55rad(Si)/s. Sample size for each cell was 5. The SMD limit for this parameter is -1LSB to 1LSB post-irradiation.

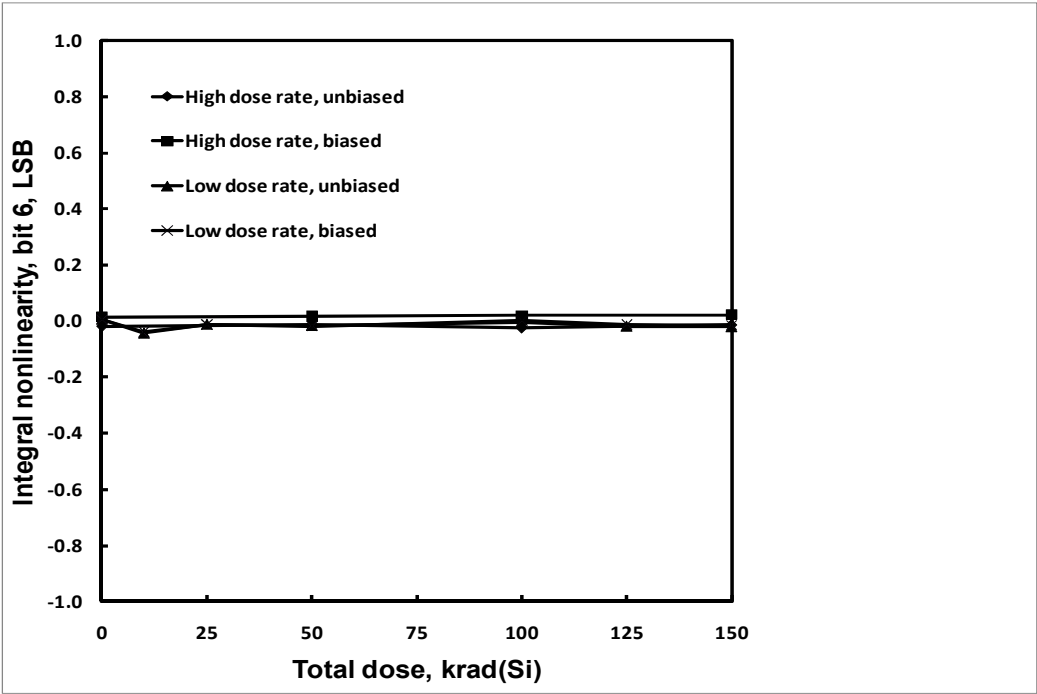

Figure 22: HS-565BRH integral nonlinearity, bit 6, as a function of total dose irradiation at low and high dose rate. The low dose rate was .01rad(Si)/s and the high dose rate was 55rad(Si)/s. Sample size for each cell was 5. The SMD limit for this parameter is -1LSB to 1LSB post-irradiation.

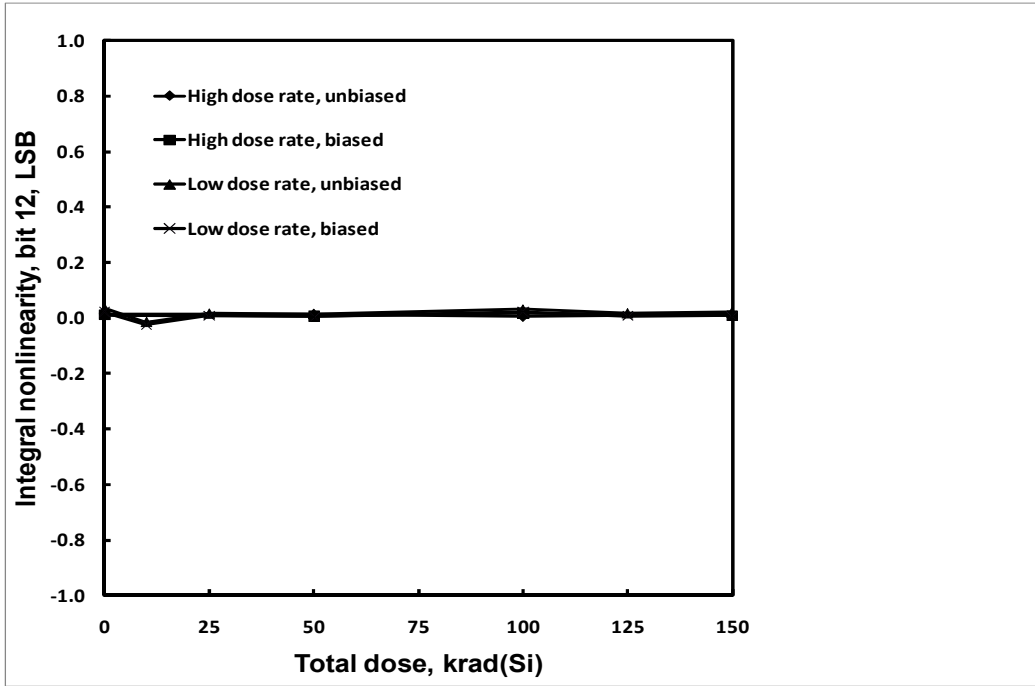

Figure 23: HS-565BRH integral nonlinearity, bit 12, as a function of total dose irradiation at low and high dose rate. The low dose rate was .01rad(Si)/s and the high dose rate was 55rad(Si)/s. Sample size for each cell was 5. The SMD limit for this parameter is -1LSB to 1LSB post-irradiation.

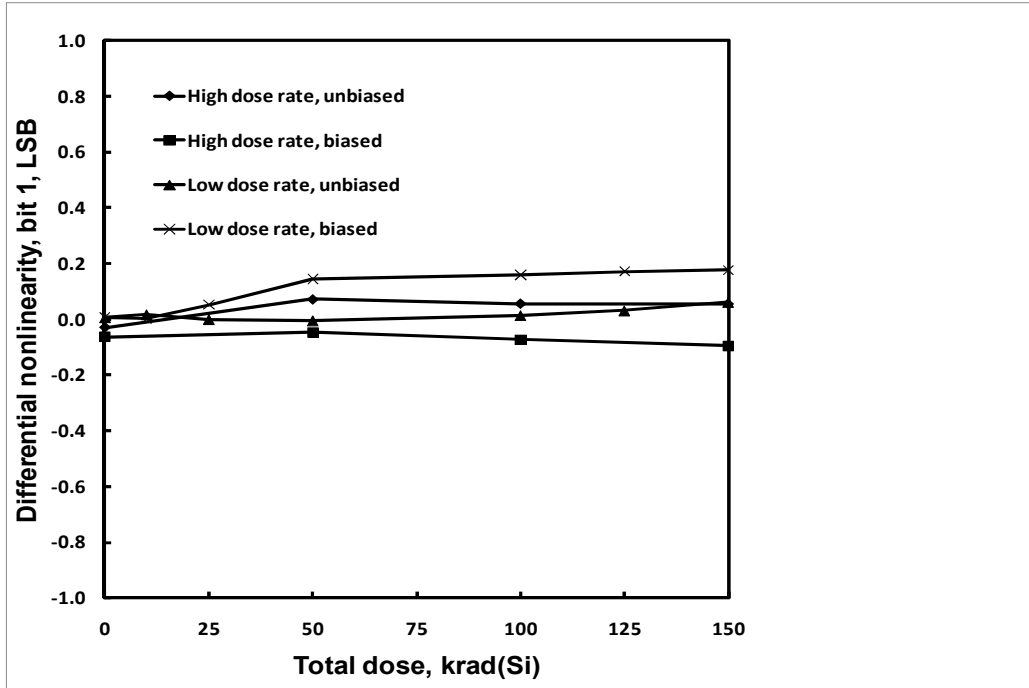

Figure 24: HS-565BRH differential nonlinearity, bit 1, as a function of total dose irradiation at low and high dose rate. The low dose rate was .01rad(Si)/s and the high dose rate was 55rad(Si)/s. Sample size for each cell was 5. The SMD limit for this parameter is -1LSB to 1LSB post-irradiation.

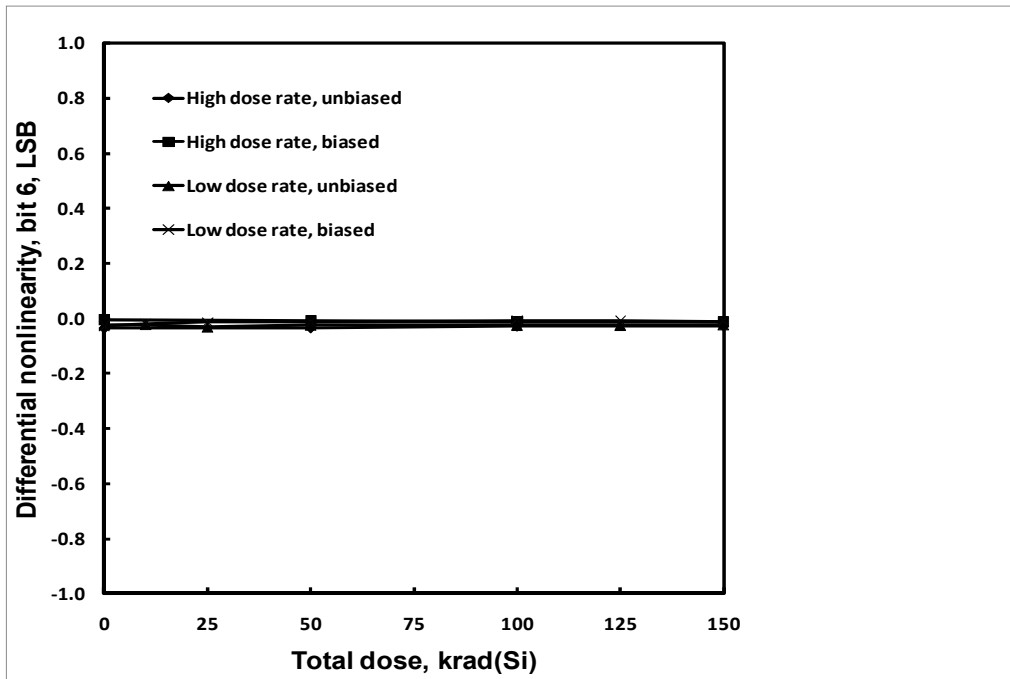

Figure 25: HS-565BRH differential nonlinearity, bit 6, as a function of total dose irradiation at low and high dose rate. The low dose rate was .01rad(Si)/s and the high dose rate was 55rad(Si)/s. Sample size for each cell was 5. The SMD limit for this parameter is -1LSB to 1LSB post-irradiation.

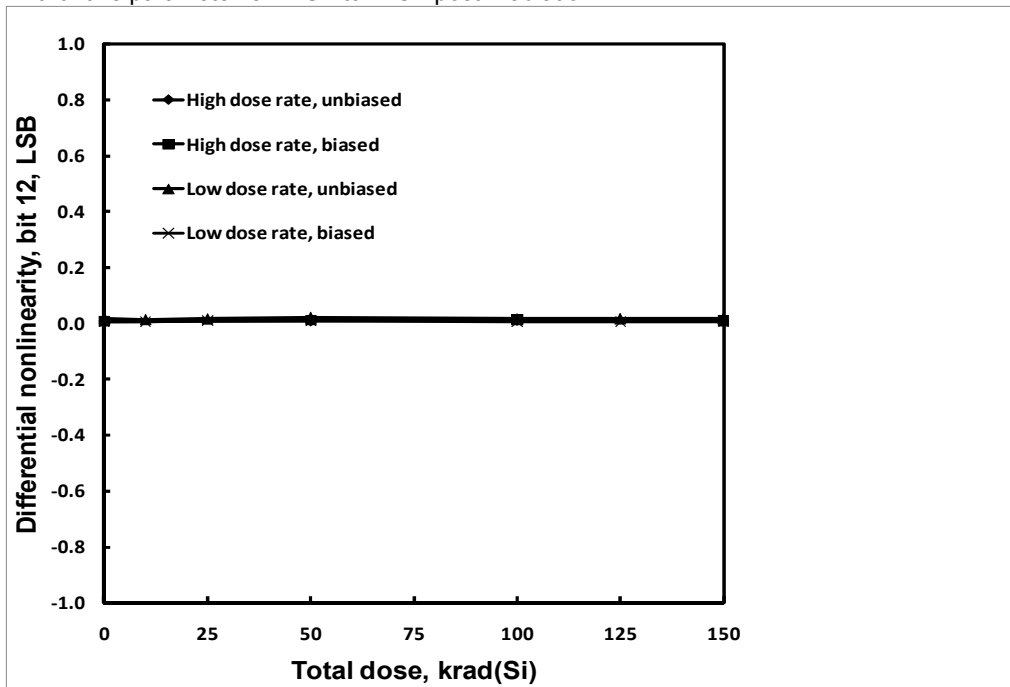

Figure 26: HS-565BRH differential nonlinearity, bit 12, as a function of total dose irradiation at low and high dose rate. The low dose rate was .01rad(Si)/s and the high dose rate was 55rad(Si)/s. Sample size for each cell was 5. The SMD limit for this parameter is -1LSB to 1LSB post-irradiation.

6: Discussion

ATE characterization of the samples at all downpoints showed no rejects tot the SMD post-irradiation limits. The data is plotted in figures 3 to 26 and showed good stability over total dose irradiation. The HS-565BRH displayed moderate low dose rate sensitivity in the reference voltage, bipolar output offset error, unipolar full scale error and bipolar full scale error parameters. The worst-case values encountered for these parameters were well within the applicable post-irradiation SMD limits. All other plotted parameters show little and sometimes no difference between the high and low dose rate response. Accordingly, the part is considered moderately low dose rate sensitive up to the 100krad(Si) data sheet total dose rating. No bias sensitivity was noted.

7: Conclusion

This document reports the results of a total dose test of the HS-565BRH 12-bit digital to analog converter (DAC). Samples were tested under biased and unbiased conditions to a maximum total dose of 150krad(Si) at high and low dose rate.

The HS-565BRH displayed moderate low dose rate sensitivity, notably in the reference voltage, bipolar output offset error, unipolar full scale error and bipolar full scale error parameters. The worst-case values encountered for these parameters were well within the applicable post-irradiation SMD limits. Accordingly, the part is considered moderately low dose rate sensitive up to the 100krad(Si) data sheet total dose rating.

No differences between biased and unbiased irradiation were noted, and the part is not considered bias sensitive.

7: Appendices

Appendix 1: Plotted parameters and limits.

Parameter	Symbol	Limits		Units	Figure
		minimum	maximum		
Positive supply current	ICC		+11.8	mA	3
Negative supply current	IEE		-14.5	mA	4
Reference voltage	VREF_OUT	9.9	10.1	V	5
Unipolar output current	IOUT1	-2.4	-1.6	mA	6
Bipolar output current	IOUT2	-1.2	-0.8	mA	7
Unipolar output offset error	VOS	-0.05	+0.05	% FS	8
Bipolar output offset error	BPOE	-0.05	+0.05	% FS	9
Unipolar full scale error	AE	-0.85	+0.85	% FS	10
Bipolar full scale error	BP AE	-0.85	+0.85	% FS	11
Bipolar zero error	BPZE	-0.25	+0.25	% FS	12
Digital input LOW current, bit 1	IIL1		-40	μ A	13
Digital input LOW current, bit 6	IIL6		-40	μ A	14
Digital input LOW current, bit 12	IIL12		-40	μ A	15
Digital input HIGH current, bit 1	IIH1		1	μ A	16
Digital input HIGH current, bit 6	IIH6		1	μ A	17
Digital input HIGH current, bit 12	IIH12		1	μ A	18
Positive power supply gain sensitivity	+PSS		10	Note 1	19
Negative power supply gain sensitivity	-PSS		25	Note 1	20
Integral nonlinearity, bit 1	ILE1	-1	+1	LSB	21
Integral nonlinearity, bit 6	ILE6	-1	+1	LSB	22
Integral nonlinearity, bit 12	ILE12	-1	+1	LSB	23
Differential nonlinearity, bit 1	DLE1	-1	+1	LSB	24
Differential nonlinearity, bit 6	DLE6	-1	+1	LSB	25
Differential nonlinearity, bit 12	DLE12	-1	+1	LSB	26

Note 1: Units for these two parameters are ppm of full scale/% Δ V_{cc}.

8: Document revision history

Revision	Date	Pages	Comments
0	August 2010	All	Original issue