



## **Total dose testing of the HS-OP470ARH radiation hardened quad operational amplifier**

**Nick van Vonno**  
**Intersil Corporation**

Revision 0  
December 2010

### **Table of Contents**

- 1. Introduction**
- 2. Reference Documents**
- 3. Part Description**
- 4. Test Description**
  - 4.1 Irradiation facility**
  - 4.2 Test fixturing**
  - 4.3 Characterization equipment and procedures**
  - 4.4 Experimental Matrix**
  - 4.5 Downpoints**
- 5 Results**
  - 5.1 Test results**
  - 5.2 Variables data**
- 6 Discussion**
- 7 Conclusion**
- 8 Appendices**
- 9 Document revision history**

## 1. Introduction

This report reports the results of a low and high dose rate total dose test of the HS-OP470ARH quad operational amplifier. The test was conducted in order to determine the sensitivity of the part to the total dose environment and to determine if dose rate and bias sensitivity exist.

## 2. Reference Documents

MIL-STD-883G test method 1019.7

HS-OP470ARH data sheet

DSCC Standard Microcircuit Drawing (SMD) 5962-98533

## 3: Part Description

The HS-OP470ARH is a radiation hardened, monolithic quad operational amplifier designed to provide reliable performance in harsh radiation environments. Its excellent noise characteristics coupled with a unique array of dynamic specifications make this amplifier well suited for satellite system applications. Dielectrically isolated bipolar processing makes this device immune to Single Event Latch-up.

The HS-OP470ARH shows minimal change in input offset voltage after exposure to 100Krad(Si) gamma radiation, with only a minor increase in input bias current. Complementing these specifications is a post radiation open loop gain in excess of 40kV/V. The part uses an industry standard pinout, allowing for interchangeability with most other quad operational amplifiers.

Specifications for Rad Hard QML devices are controlled by the Defense Supply Center in Columbus (DSCC). Detailed electrical specifications are contained in SMD 5962-98533. A "hot-link" is provided on the Intersil homepage for access to the SMD.

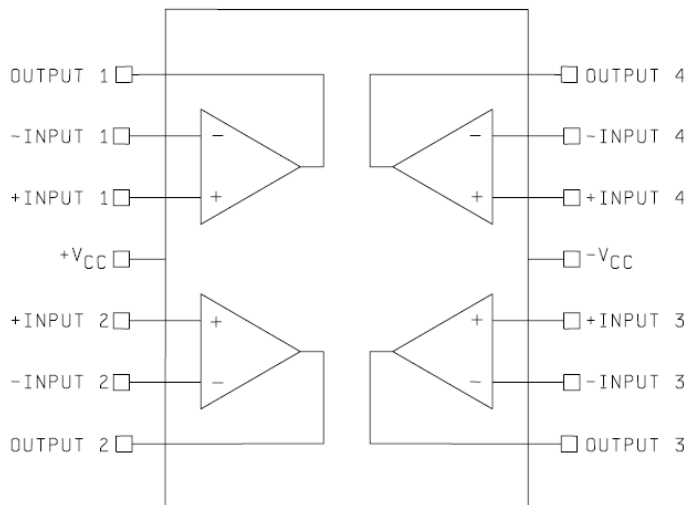

Fig. 1: HS-OP470ARH block diagram.

## 4: Test Description

### 4.1 Irradiation Facilities

High dose rate testing was performed using a Gammacell 220 <sup>60</sup>Co irradiator located in the Palm Bay, Florida Intersil facility. Low dose rate testing was performed on a subcontract basis at White Sands Missile Range (WSMR) Survivability, Vulnerability and Assessment Directorate (SVAD), White Sands, NM, using a vault-type <sup>60</sup>Co irradiator. The high dose rate irradiations were done at 55rad(Si)/s and the low dose rate work was performed at 0.010rad(Si)/s, both per MIL-STD-883 Method 1019.7.

### 4.2 Test Fixturing

Table 1, below, shows the configuration used for biased irradiation in conformance with Standard Microcircuit Drawing (SMD) 5962-98533.

Test	Ground	V+	V-	OUT to -IN, each amplifier
Radiation exposure	Pins 3, 5, 10, 12	Pin 4	Pin11	Pins 1 to 2, 7 to 6, 8 to 9, 14 to 13

**Table 1:** Irradiation bias configuration for the HS-OP470ARH per Standard Microcircuit Drawing (SMD) 5962-98533. ( $T_A = +25^{\circ}\text{C} \pm 5^{\circ}\text{C}$ ,  $V+ = 15\text{V} \pm 0.5\text{V}$ ,  $V- = -15\text{V} \pm 0.5\text{V}$ )

### 4.3 Characterization equipment and procedures

All electrical testing was performed outside the irradiator using the production automated test equipment (ATE) with datalogging at each downpoint. Downpoint electrical testing was performed at room temperature. Performing low dose rate testing at a remote site introduces some challenges, and shipping had to be done in a foam container with a frozen Gelpack™ along with a strip chart temperature recorder in order to remain well within the temperature limits imposed by MIL-STD-883 Test Method 1019.7. Close coordination between the two organizations is required, and support by WSMR is gratefully acknowledged.

### 4.4 Experimental matrix

Total dose irradiations proceeded in accordance with the guidelines of MIL-STD-883 Test Method 1019.7. The experimental matrix consisted of five samples irradiated at high dose rate with all pins grounded, five samples irradiated at high dose rate under bias, five samples irradiated at low dose rate with all pins grounded and five samples irradiated at low dose rate under bias. One control unit was used.

Samples of the HS-OP470ARH die were drawn from production lot DCEVVNA and were packaged in the standard hermetic 14-pin solder-sealed flatpack (CDFP4-F14) production package. Samples were processed through the standard burnin cycle before irradiation, as required by MIL-STD-883, and were screened to the SMD 5962-98533 limits at room, low and high temperatures prior to the test.

## 4.5 Downpoints

Downpoints were 0, 10, 25, 50, 100 and 150krad(Si) for the high dose rate test and 0, 10, 25, 50, 100, 125 and 150krad(Si) for the low dose rate test.

## 5: Results

### 5.1 Test results

Testing to 150krad(Si) at both dose rates of the HS-OP470ARH is complete.

The input offset voltage was stable and was well within the +/-2.6mV SMD post-irradiation specification at the 150krad(Si) downpoint. The positive input bias current was outside the +/-630nA post-irradiation limit for the biased low dose rate samples at the 25krad(Si) downpoint and was then stable out to the 150krad(Si) level. The positive input bias current was stable out to 150krad(Si) for the grounded low dose rate samples and for the grounded and biased high dose rate samples. We believe the biased low dose rate samples were overstressed during irradiation before the 25krad(Si) level and thus consider the data for these samples to be artifactual. The input offset current represents the difference between the two input bias current values and was hence out of specification for the biased low dose rate samples as well.

Open-loop gain and output current showed some degradation but was within the SMD post-irradiation limits after 150krad(Si). Common mode rejection ratio, power supply rejection ratio, output voltage swing and power supply current were all stable. Rise and fall time and overshoot were stable, while slew rate showed some decrease but was well within the SMD limits at the 150krad(Si) level.

The part is implemented in the Intersil EBHF process. This work is the first Intersil low dose rate vs. high dose rate test of this process. The HS-OP470ARH data showed little, if any, low dose rate or bias sensitivity, with the low dose rate biased condition marginally worst-case for some parameters. The EBHF process uses a multilayer nitride over Silox passivation structure consisting of 12000Å of silicon dioxide ('Silox') and 3500Å of silicon nitride, with the nitride the upper layer and the Silox in contact with the chip. Passivation structure, composition and deposition process have been shown to strongly affect the low and high dose rate response of the resulting parts. This result is in disagreement with data for Intersil RSG parts, which uses single-layer Silox passivation. In these parts the grounded low dose rate condition was generally found to be worst case.

### 5.2 Variables data

The plots in Figures 2 through 91 show data for at all downpoints. The plots show the median of key parameters as a function of total dose for each of the four irradiation conditions. We chose to plot the median for these parameters due to the relatively small sample sizes involved.

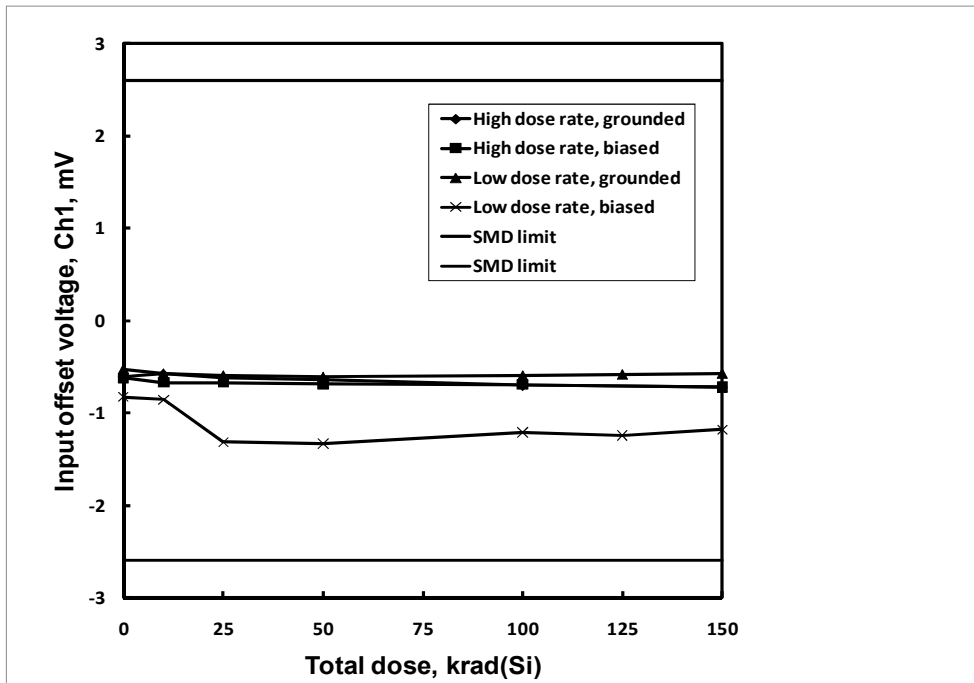

**Fig. 2:** HS-OP470ARH input offset voltage, channel 1, as a function of total dose irradiation at low and high dose rate for the unbiased (all pins grounded) and the biased (per Table 1) cases. The low dose rate was 0.01rad(Si)/s and the high dose rate 55rad(Si)/s. Sample size for each cell was 5. The post-irradiation SMD limits are -2.6mV to +2.6mV.

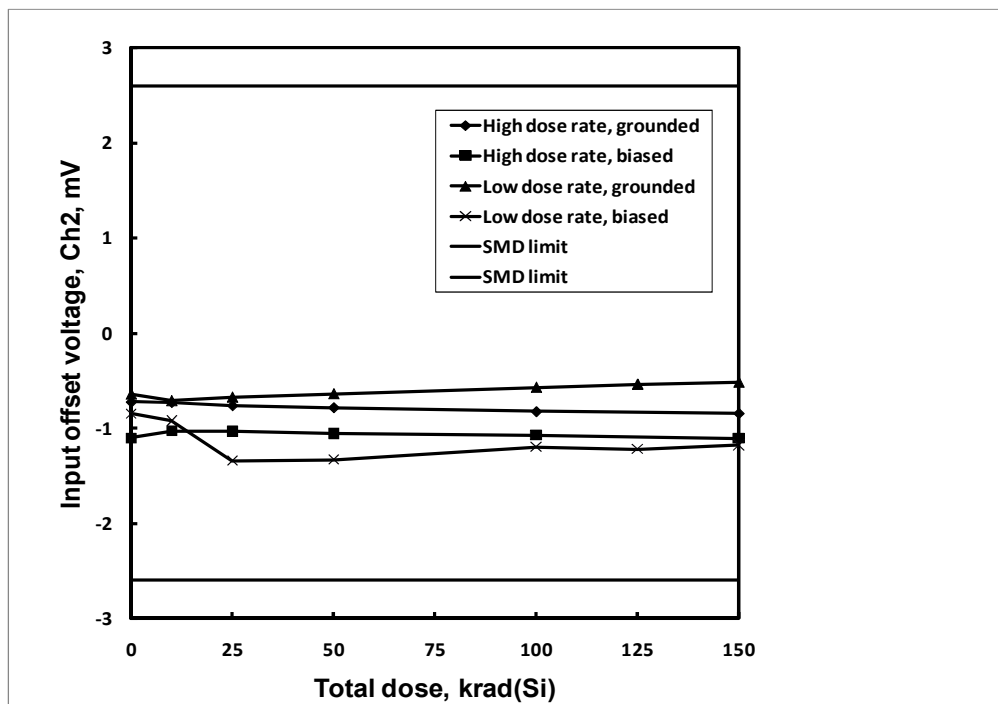

**Fig. 3:** HS-OP470ARH input offset voltage, channel 2, as a function of total dose irradiation at low and high dose rate for the unbiased (all pins grounded) and the biased (per Table 1) cases. The low dose rate was 0.01rad(Si)/s and the high dose rate 55rad(Si)/s. Sample size for each cell was 5. The post-irradiation SMD limits are -2.6mV to +2.6mV.

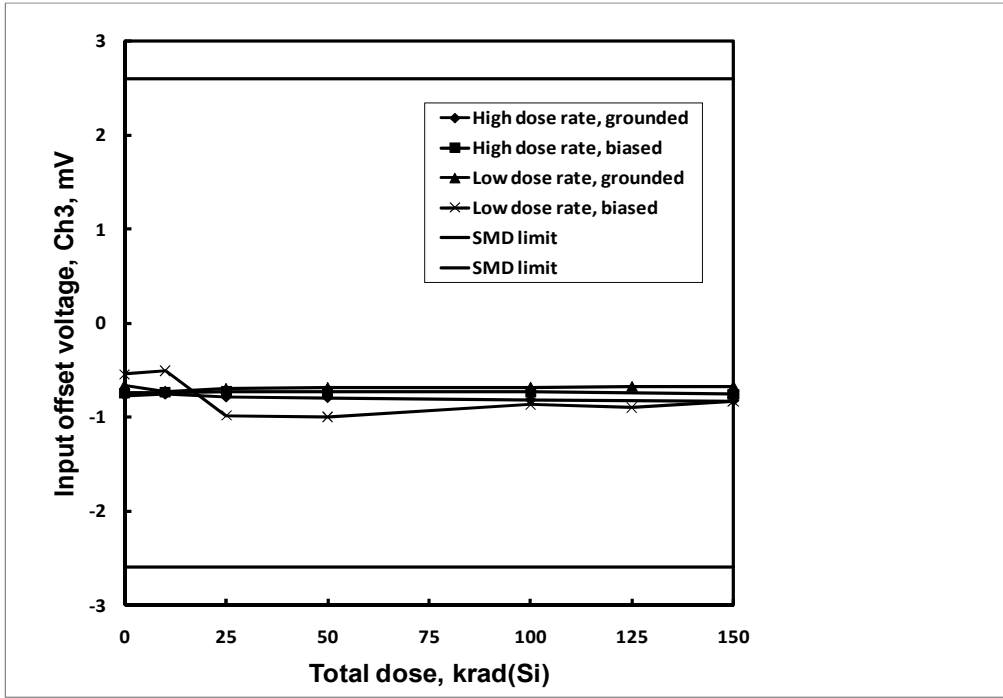

Fig. 4: HS-OP470ARH input offset voltage, channel 3, as a function of total dose irradiation at low and high dose rate for the unbiased and biased cases. The post-irradiation SMD limits are -2.6mV to +2.6mV.

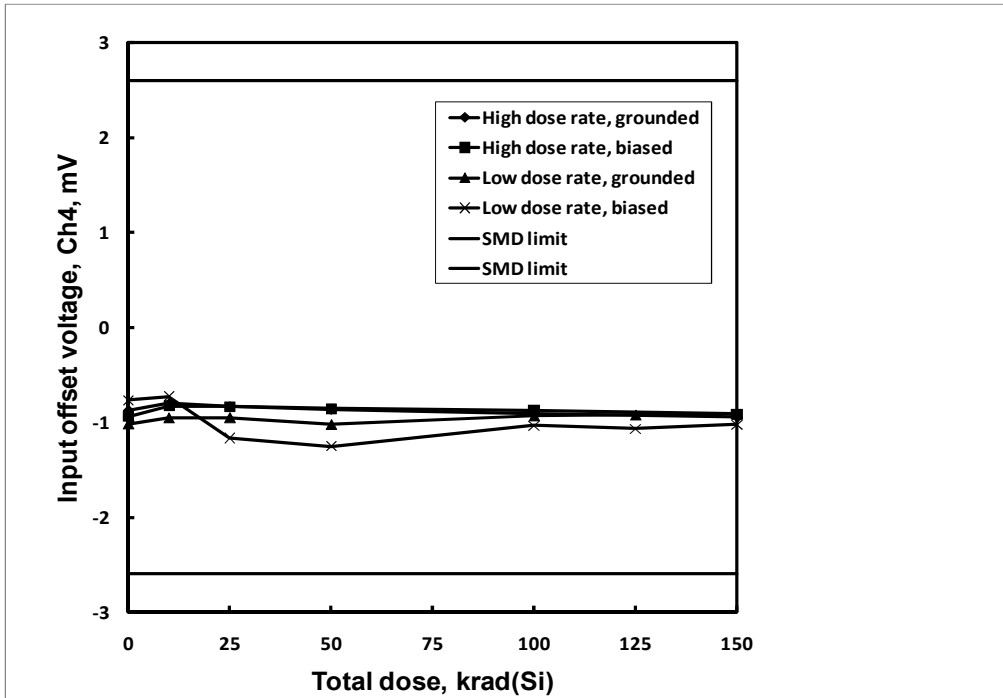

Fig. 5: HS-OP470ARH input offset voltage, channel 4, as a function of total dose irradiation at low and high dose rate for the unbiased and biased cases. The post-irradiation SMD limits are -2.6mV to +2.6mV.

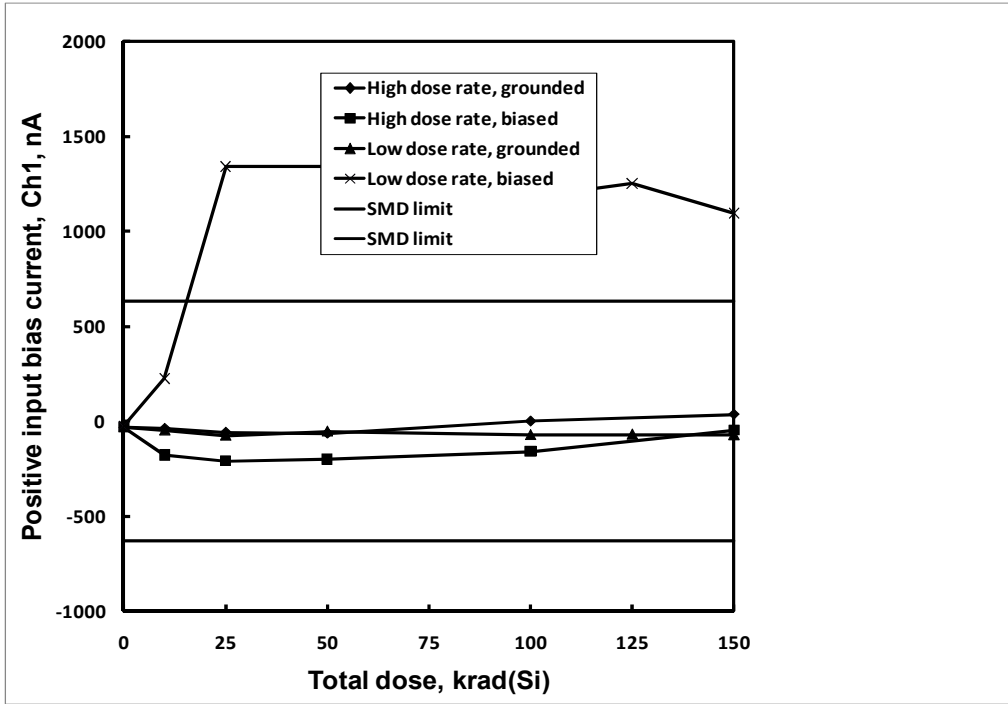

Fig. 6: HS-OP470ARH positive input bias current, channel 1, as a function of total dose irradiation at low and high dose rate for the unbiased and biased cases. The post-irradiation SMD limits are -630nA to +630nA.

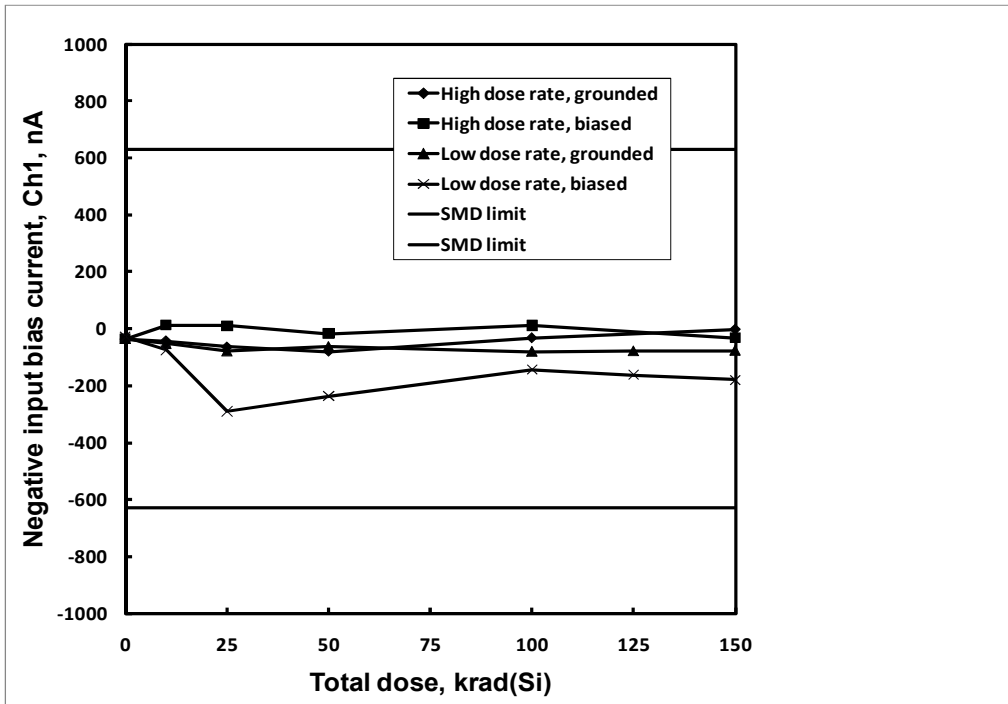

Fig. 7: HS-OP470ARH negative input bias current, channel 1, as a function of total dose irradiation at low and high dose rate for the unbiased and biased cases. The post-irradiation SMD limits are -630nA to +630nA.

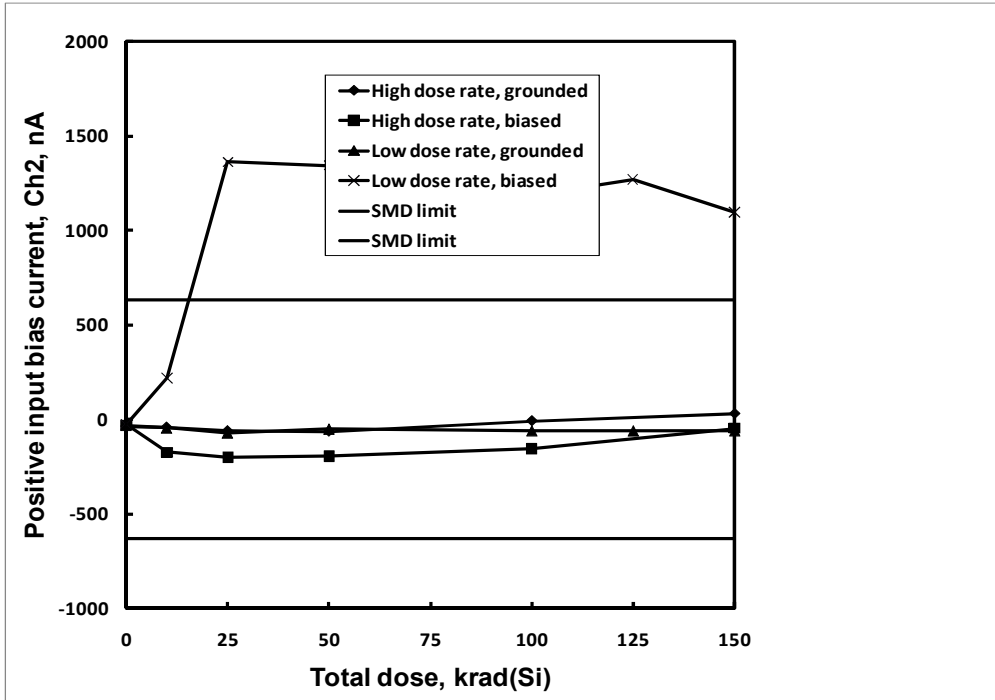

Fig. 8: HS-OP470ARH positive input bias current, channel 2, as a function of total dose irradiation at low and high dose rate for the unbiased and biased cases. The post-irradiation SMD limits are -630nA to +630nA.

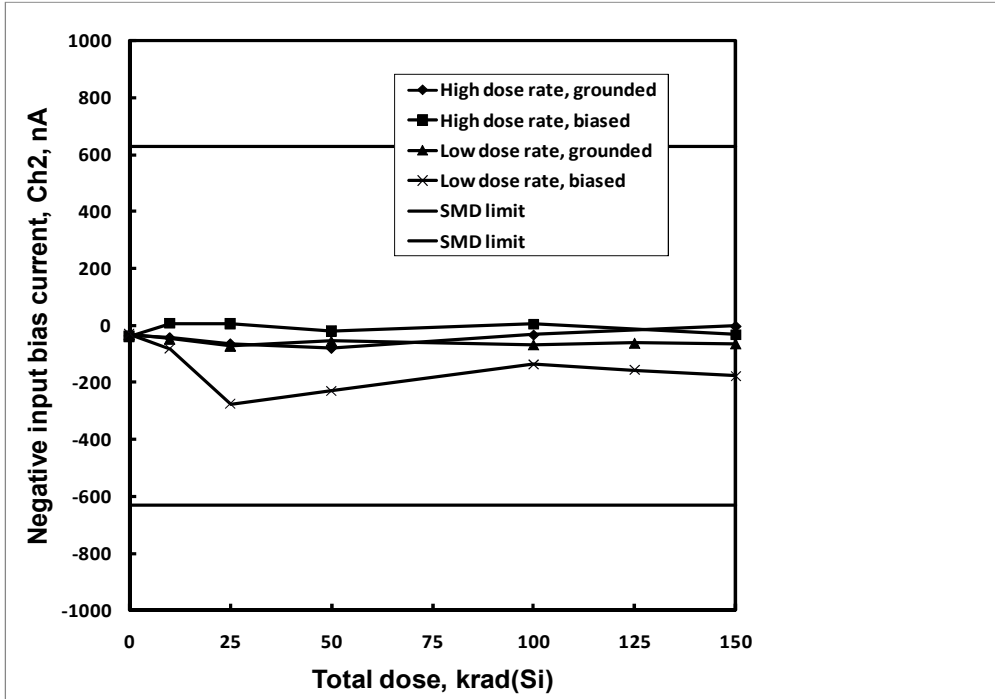

Fig. 9: HS-OP470ARH negative input bias current, channel 2, as a function of total dose irradiation at low and high dose rate for the unbiased and biased cases. The post-irradiation SMD limits are -630nA to +630nA.



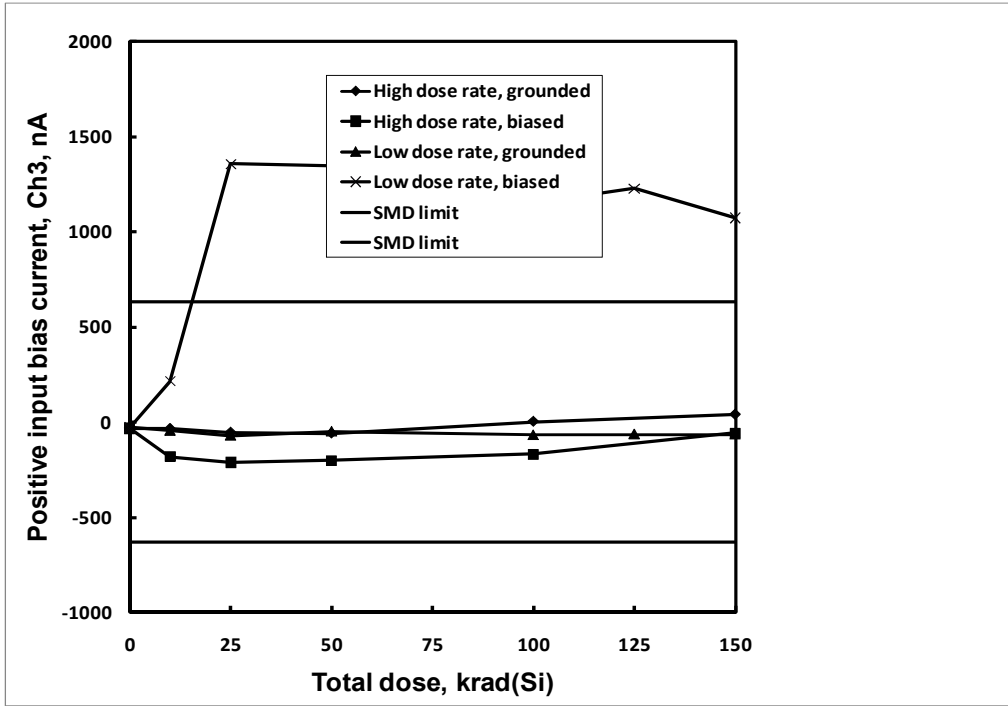

Fig. 10: HS-OP470ARH positive input bias current, channel 3, as a function of total dose irradiation at low and high dose rate for the unbiased and biased cases. The post-irradiation SMD limits are -630nA to +630nA.

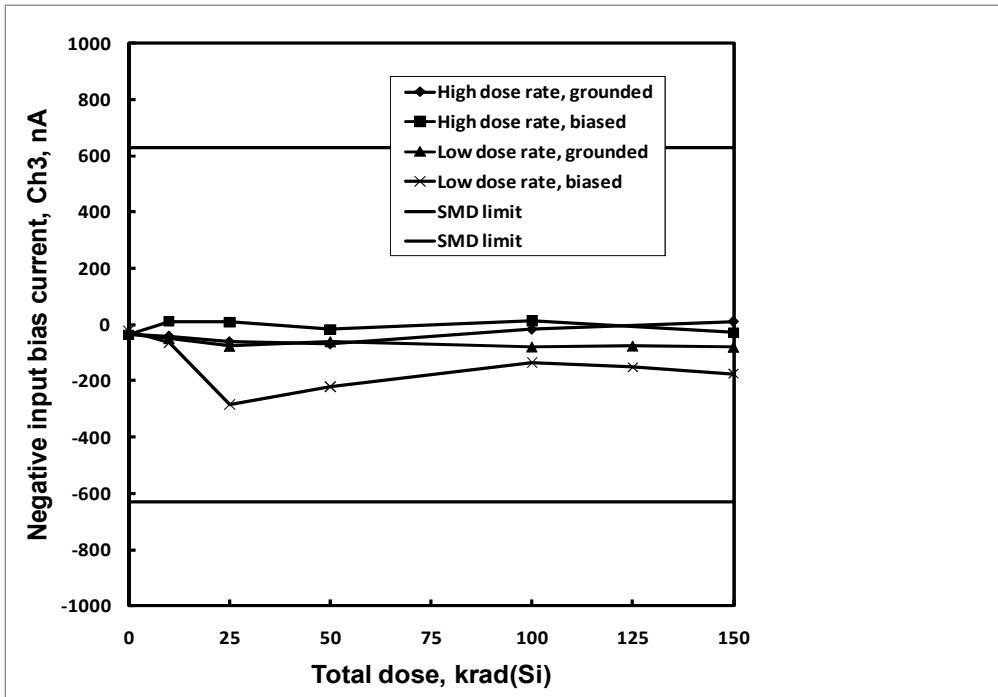

Fig. 11: HS-OP470ARH negative input bias current, channel 3, as a function of total dose irradiation at low and high dose rate for the unbiased and biased cases. The post-irradiation SMD limits are -630nA to +630nA.

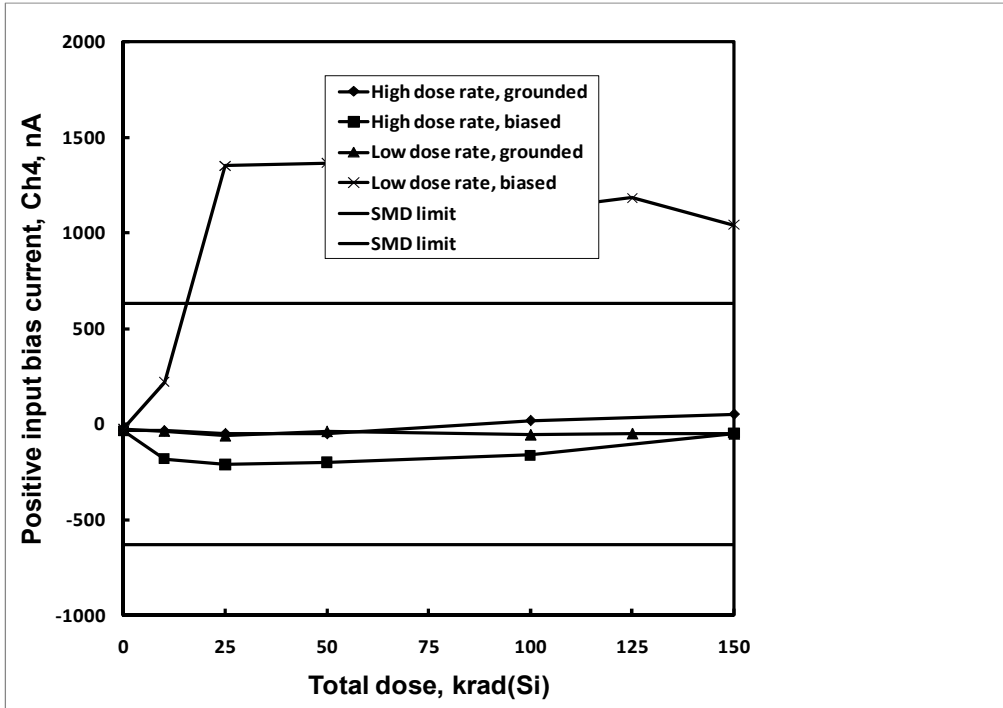

Fig. 12: HS-OP470ARH positive input bias current, channel 4, as a function of total dose irradiation at low and high dose rate for the unbiased and biased cases. The post-irradiation SMD limits are -630nA to +630nA.

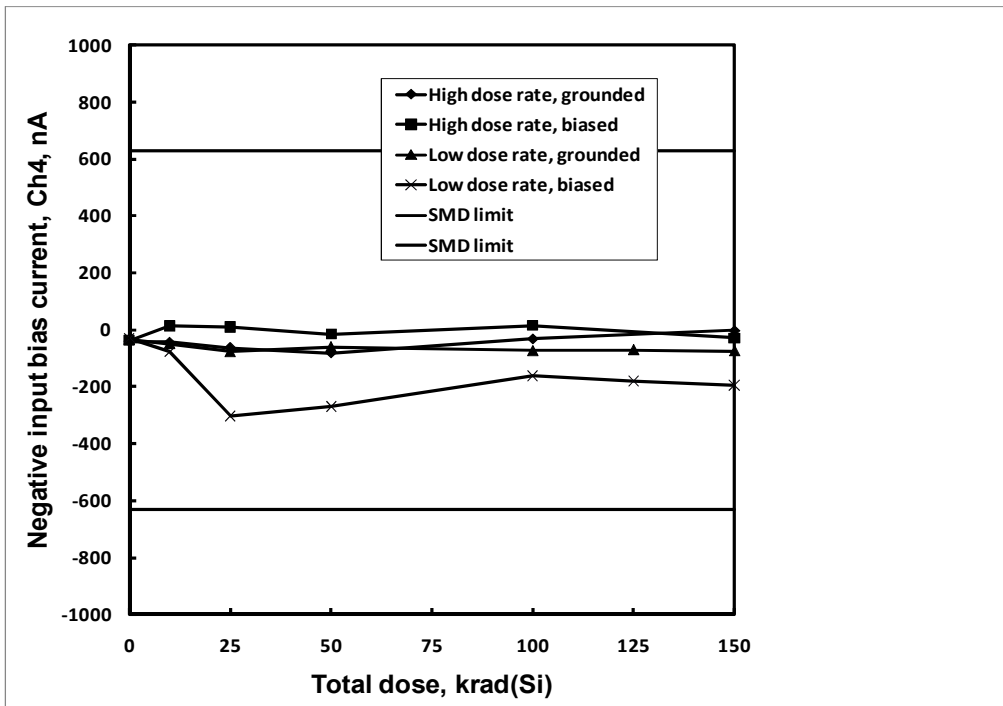

Fig. 13: HS-OP470ARH negative input bias current, channel 4, as a function of total dose irradiation at low and high dose rate for the unbiased and biased cases. The post-irradiation SMD limits are -630nA to +630nA.

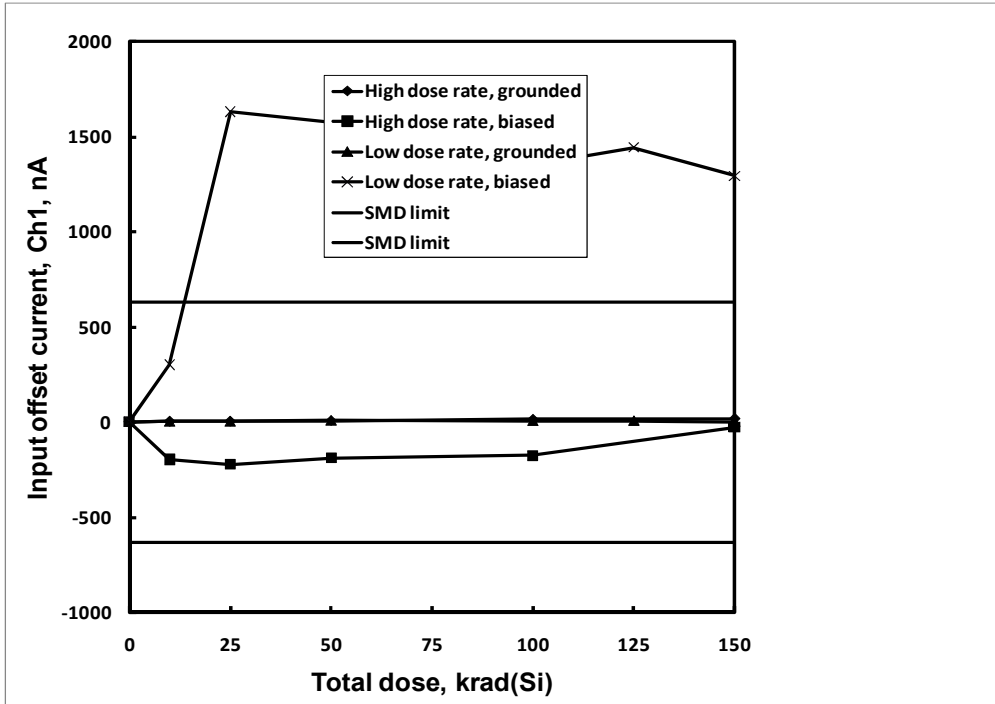

Fig. 14: HS-OP470ARH input offset current, channel 1, as a function of total dose irradiation at low and high dose rate for the unbiased and biased cases. The post-irradiation SMD limits are -630nA to +630nA.

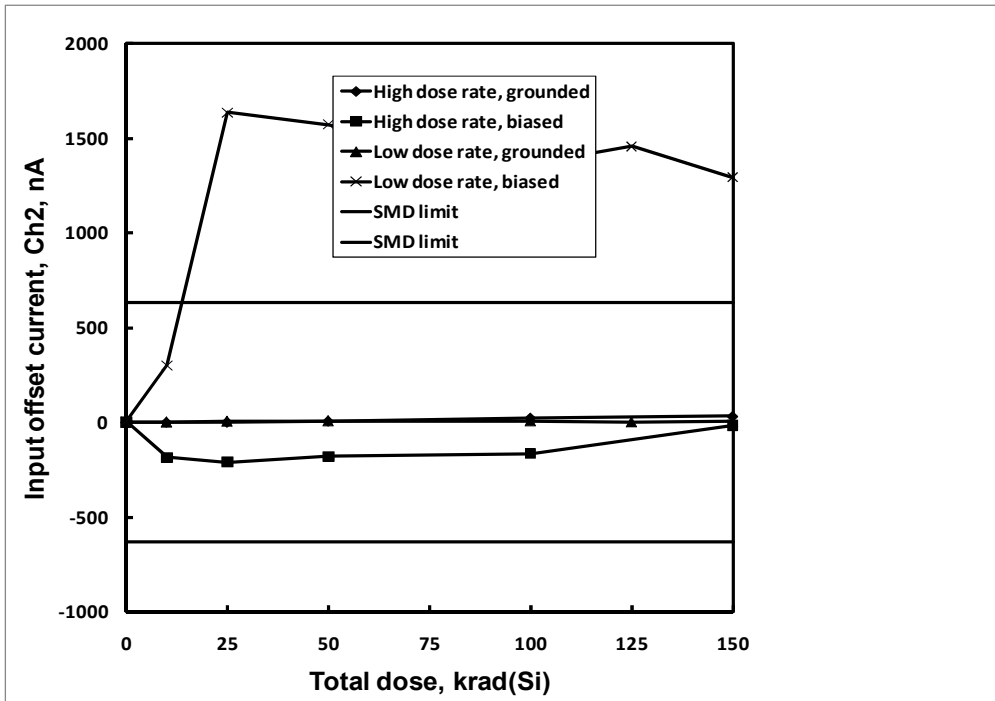

Fig. 15: HS-OP470ARH input offset current, channel 2, as a function of total dose irradiation at low and high dose rate for the unbiased and biased cases. The post-irradiation SMD limits are -630nA to +630nA.

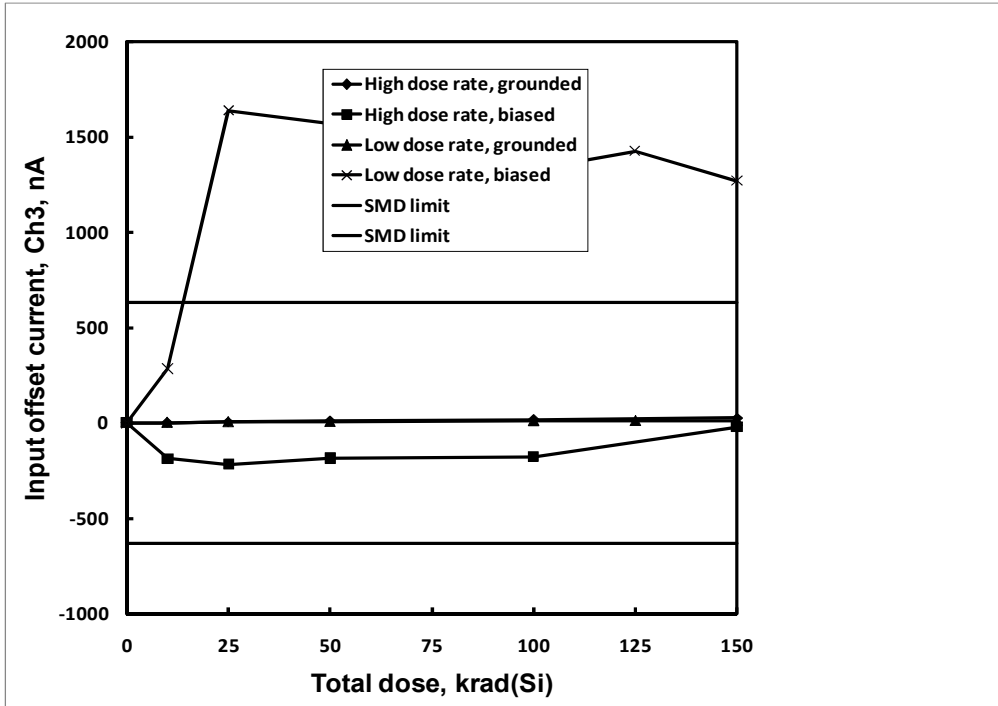

Fig. 16: HS-OP470ARH input offset current, channel 3, as a function of total dose irradiation at low and high dose rate for the unbiased and biased cases. The post-irradiation SMD limits are -630nA to +630nA.

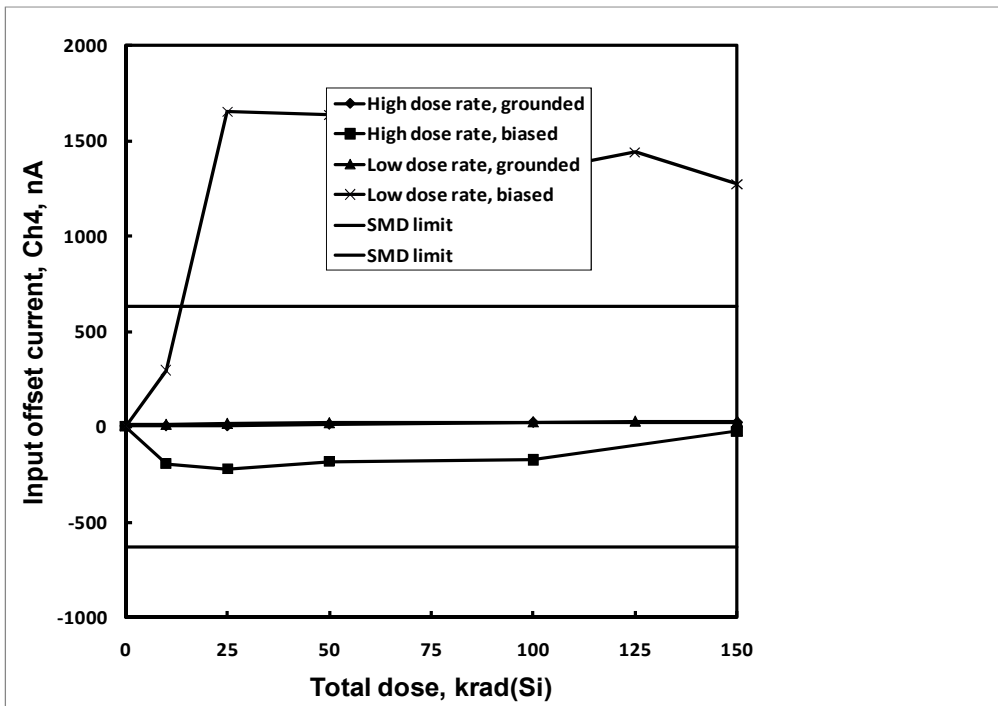

Fig. 17: HS-OP470ARH input offset current, channel 4, as a function of total dose irradiation at low and high dose rate for the unbiased and biased cases. The post-irradiation SMD limits are -630nA to +630nA.

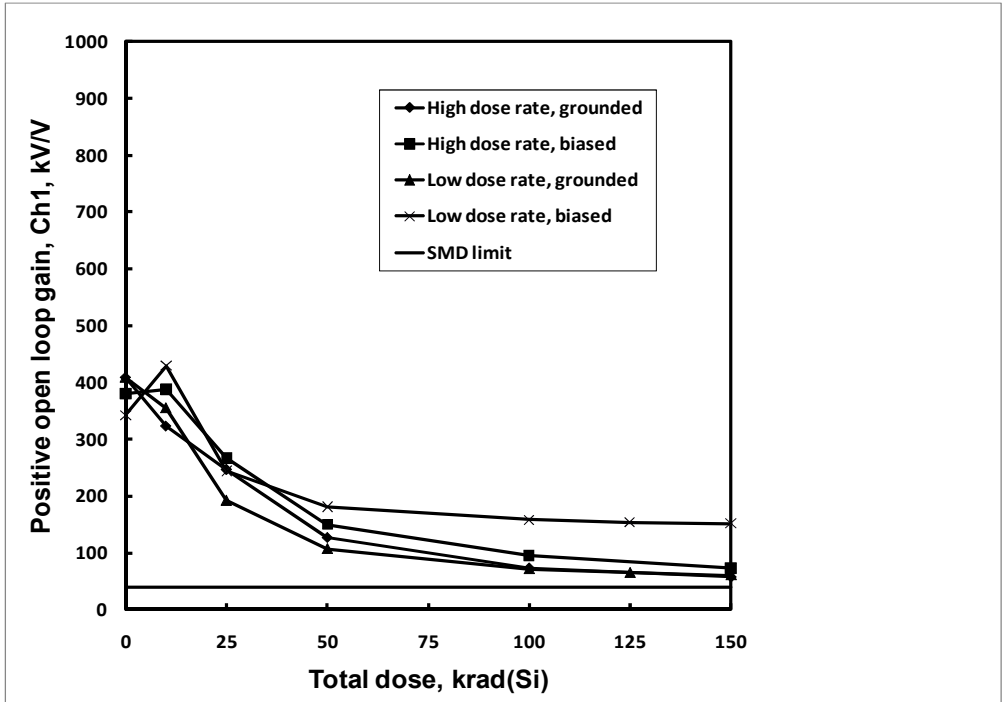

Fig. 18: HS-OP470ARH positive large signal open-loop voltage gain, channel 1, as a function of total dose irradiation at low and high dose rate for the unbiased and biased cases. The post-irradiation SMD limit is 40kV/V (92dB) minimum.

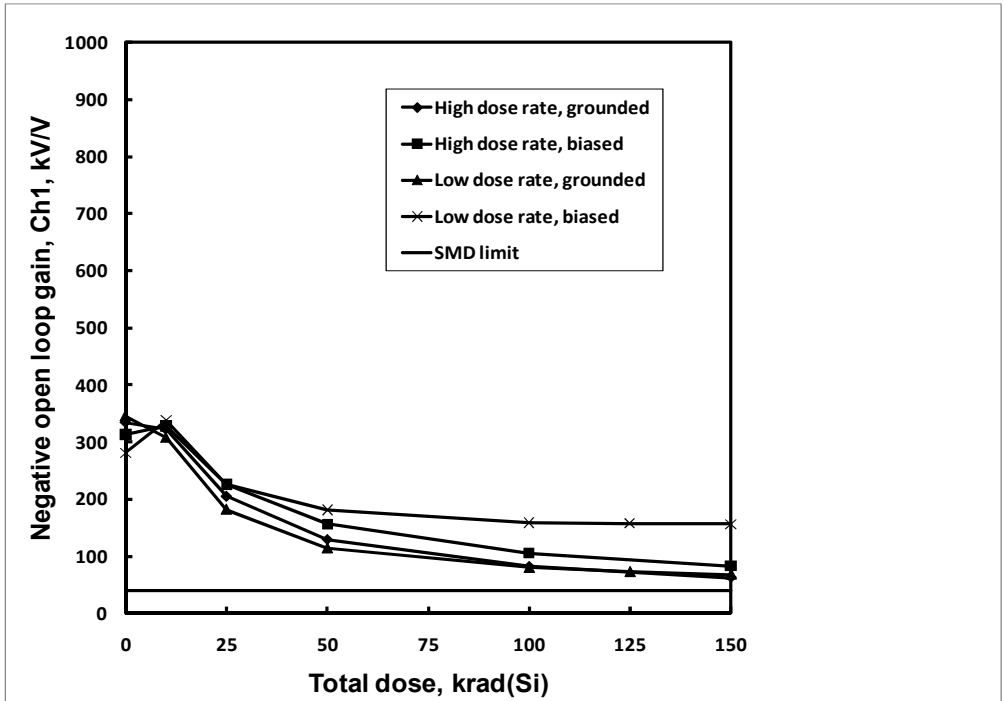

Fig. 19: HS-OP470ARH negative large signal open-loop voltage gain, channel 1, as a function of total dose irradiation at low and high dose rate for the unbiased and biased cases. The post-irradiation SMD limit is 40kV/V (92dB) minimum.

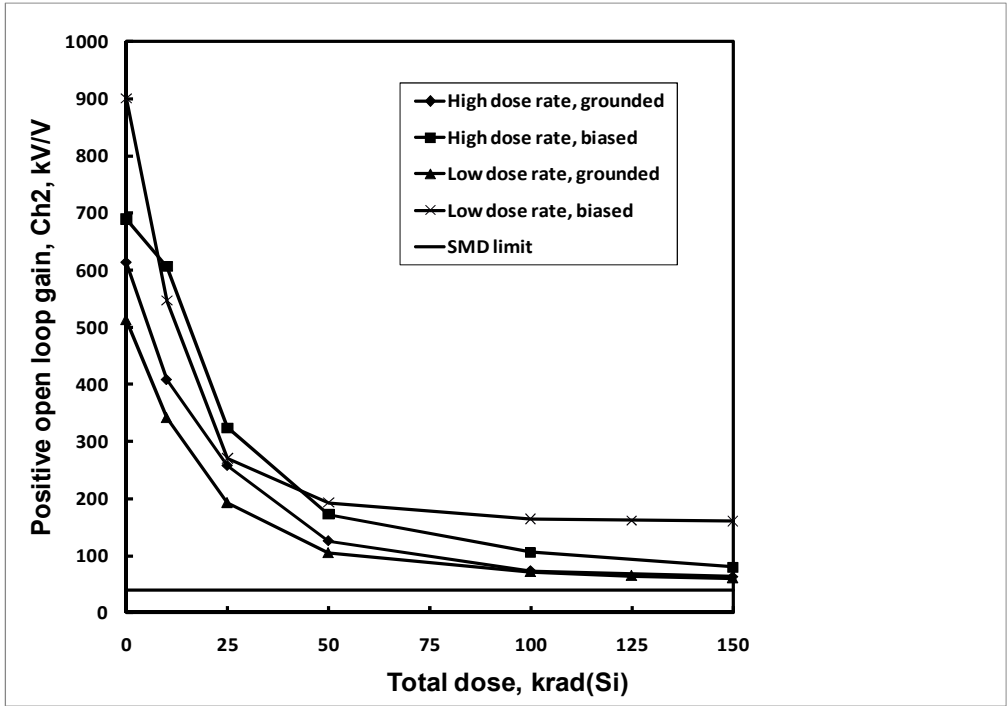

Fig. 20: HS-OP470ARH positive large signal open-loop voltage gain, channel 2, as a function of total dose irradiation at low and high dose rate for the unbiased and biased cases. The post-irradiation SMD limit is 40kV/V (92dB) minimum.

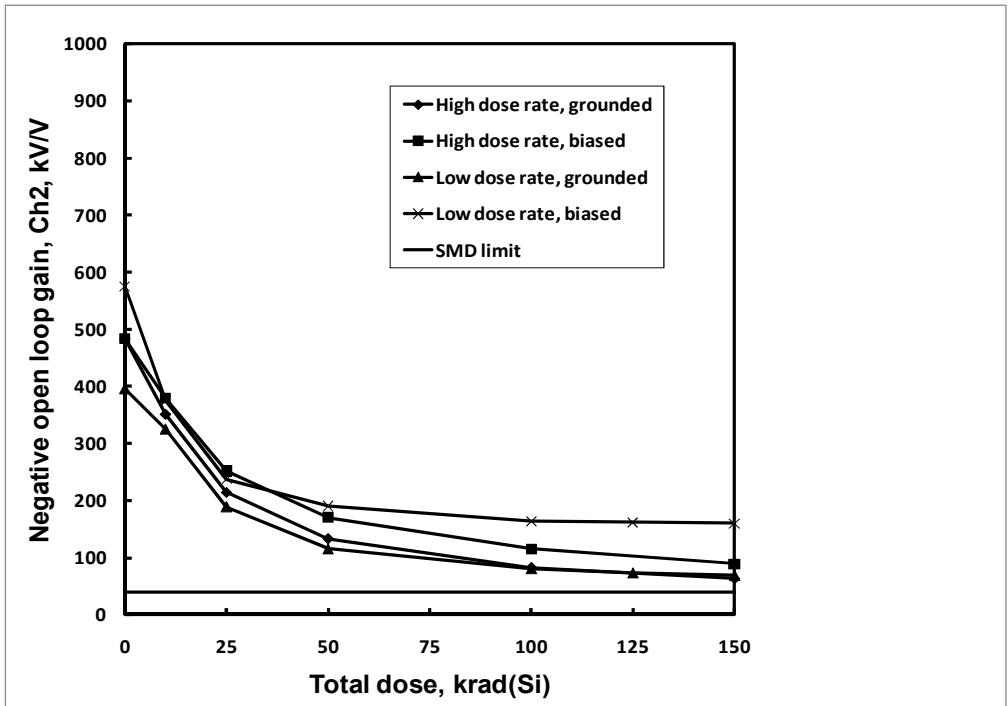

Fig. 21: HS-OP470ARH negative large signal open-loop voltage gain, channel 2, as a function of total dose irradiation at low and high dose rate for the unbiased and biased cases. The post-irradiation SMD limit is 40kV/V (92dB) minimum.

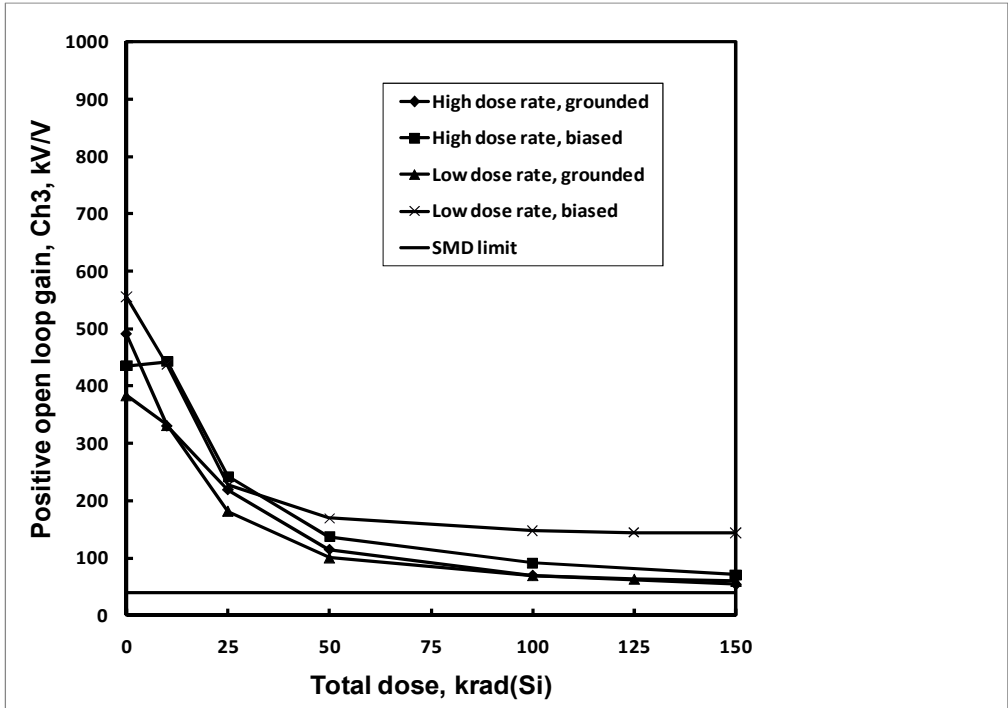

Fig. 22: HS-OP470ARH positive large signal open-loop voltage gain, channel 3, as a function of total dose irradiation at low and high dose rate for the unbiased and biased cases. The post-irradiation SMD limit is 40kV/V (92dB) minimum.

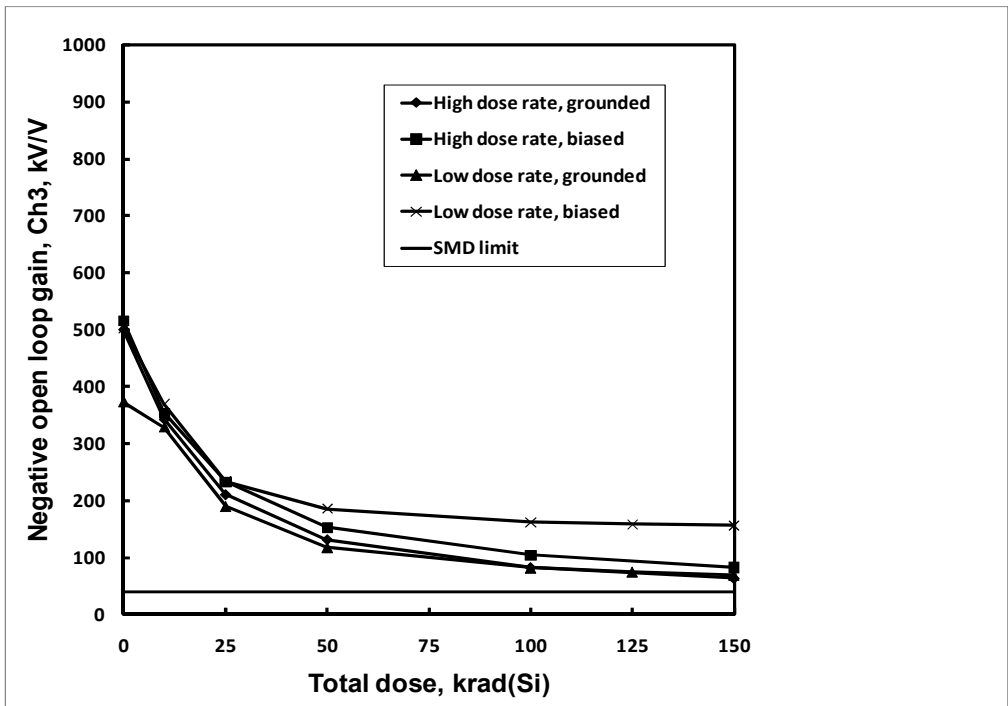

Fig. 23: HS-OP470ARH negative large signal open-loop voltage gain, channel 3, as a function of total dose irradiation at low and high dose rate for the unbiased and biased cases. The post-irradiation SMD limit is 40kV/V (92dB) minimum.

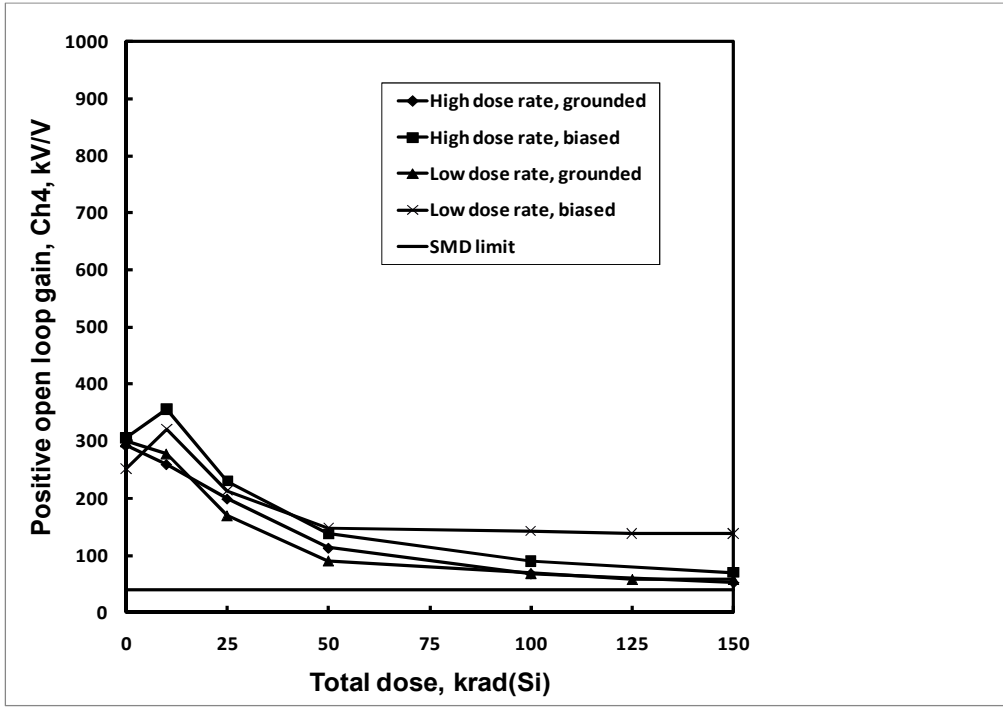

Fig. 24: HS-OP470ARH positive large signal open-loop voltage gain, channel 4, as a function of total dose irradiation at low and high dose rate for the unbiased and biased cases. The post-irradiation SMD limit is 40kV/V (92dB) minimum.

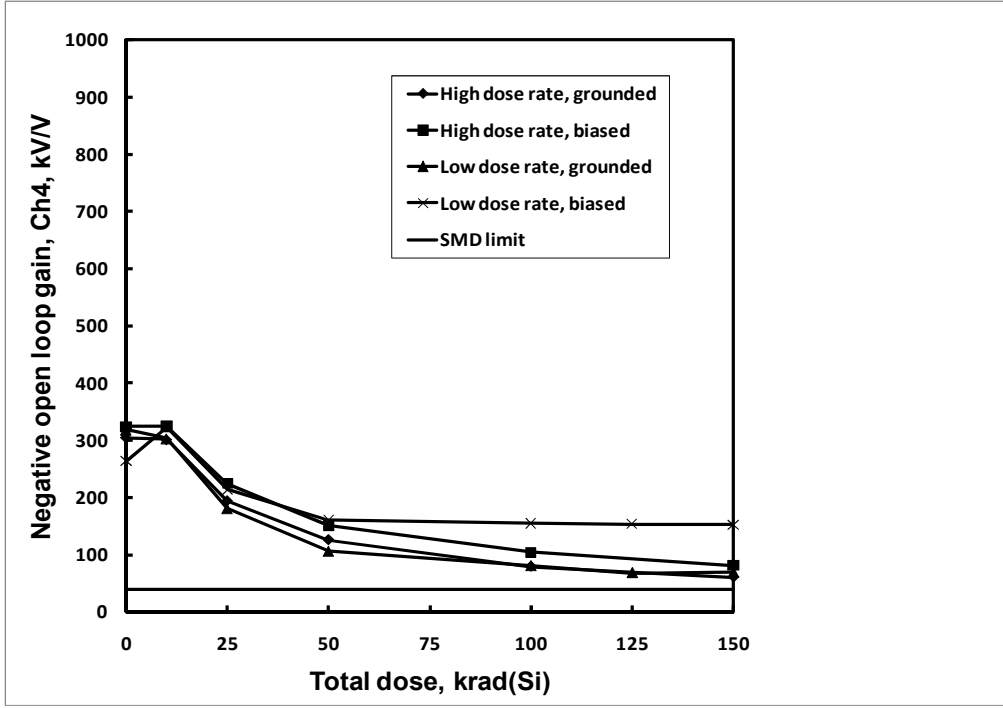

Fig. 25: HS-OP470ARH negative large signal open-loop voltage gain, channel 4, as a function of total dose irradiation at low and high dose rate for the unbiased and biased cases. The post-irradiation SMD limit is 40kV/V (92dB) minimum.



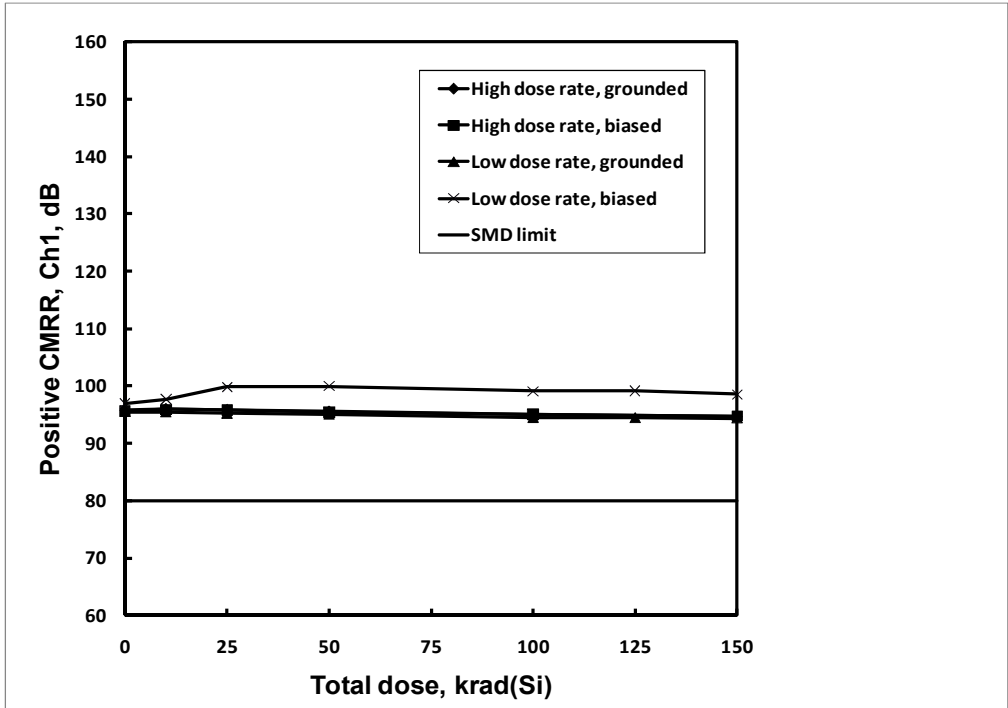

Fig. 26: HS-OP470ARH positive common-mode rejection ratio, channel 1, as a function of total dose irradiation at low and high dose rate for the unbiased and biased cases. The post-irradiation SMD limit is 80dB minimum.

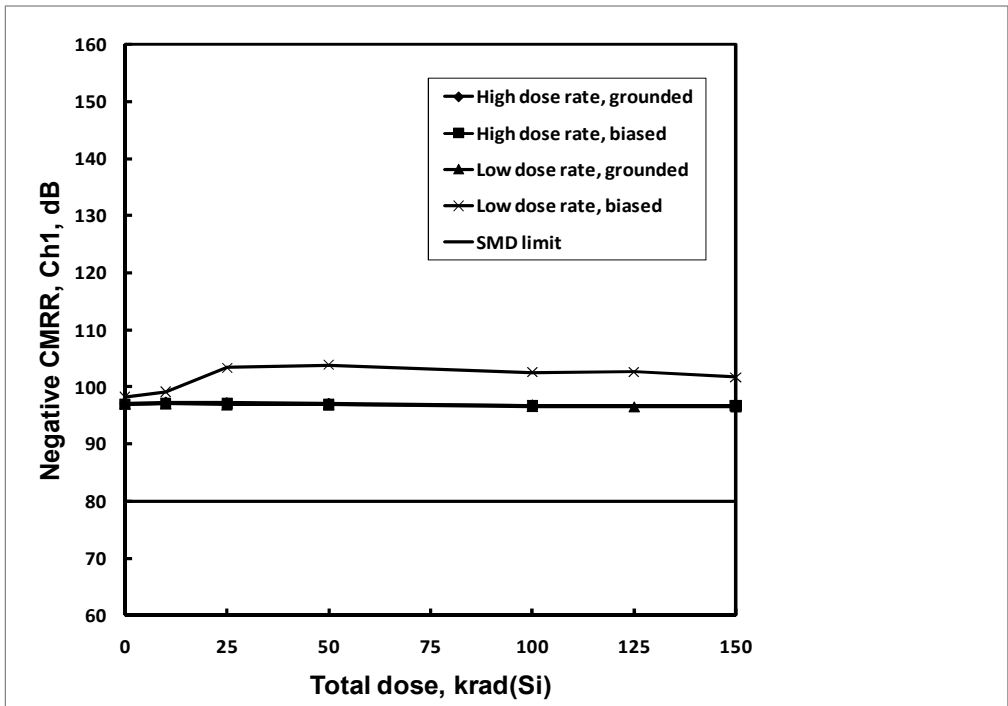

Fig. 27: HS-OP470ARH negative common-mode rejection ratio, channel 1, as a function of total dose irradiation at low and high dose rate for the unbiased and biased cases. The post-irradiation SMD limit is 80dB minimum.

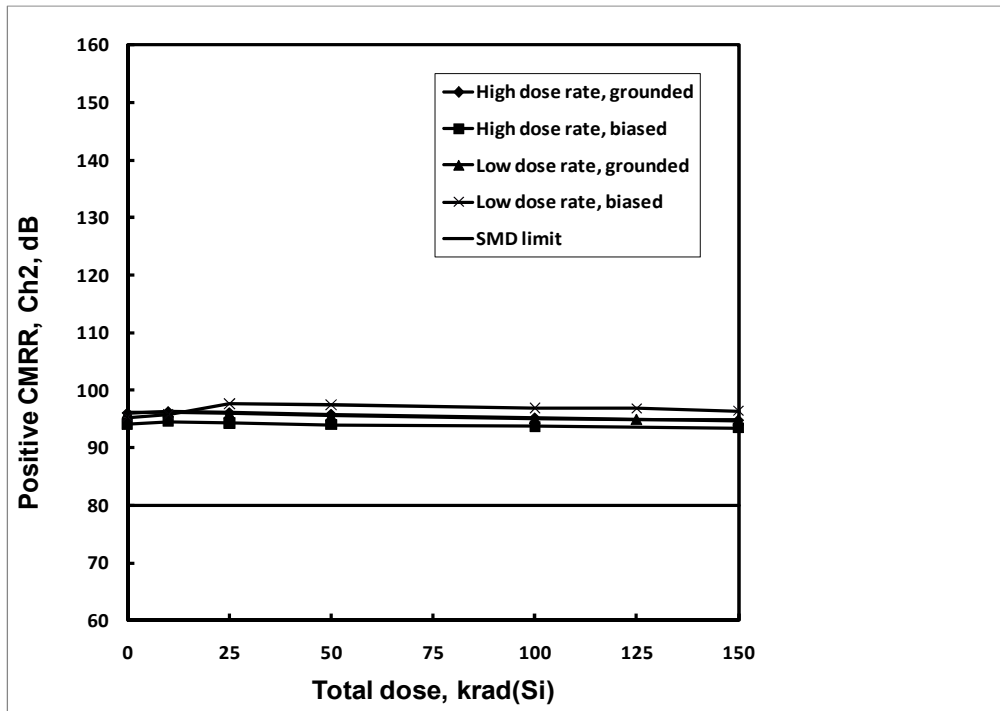

Fig. 28: HS-OP470ARH positive common-mode rejection ratio, channel 2, as a function of total dose irradiation at low and high dose rate for the unbiased and biased cases. The post-irradiation SMD limit is 80dB minimum.

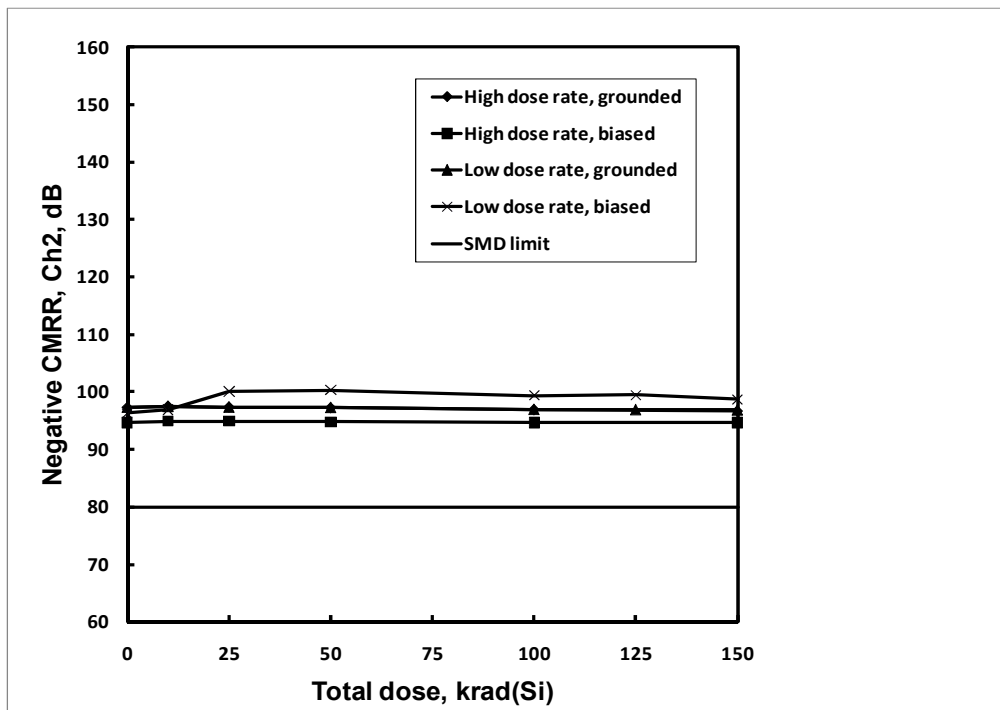

Fig. 29: HS-OP470ARH negative common-mode rejection ratio, channel 2, as a function of total dose irradiation at low and high dose rate for the unbiased and biased cases. The post-irradiation SMD limit is 80dB minimum.

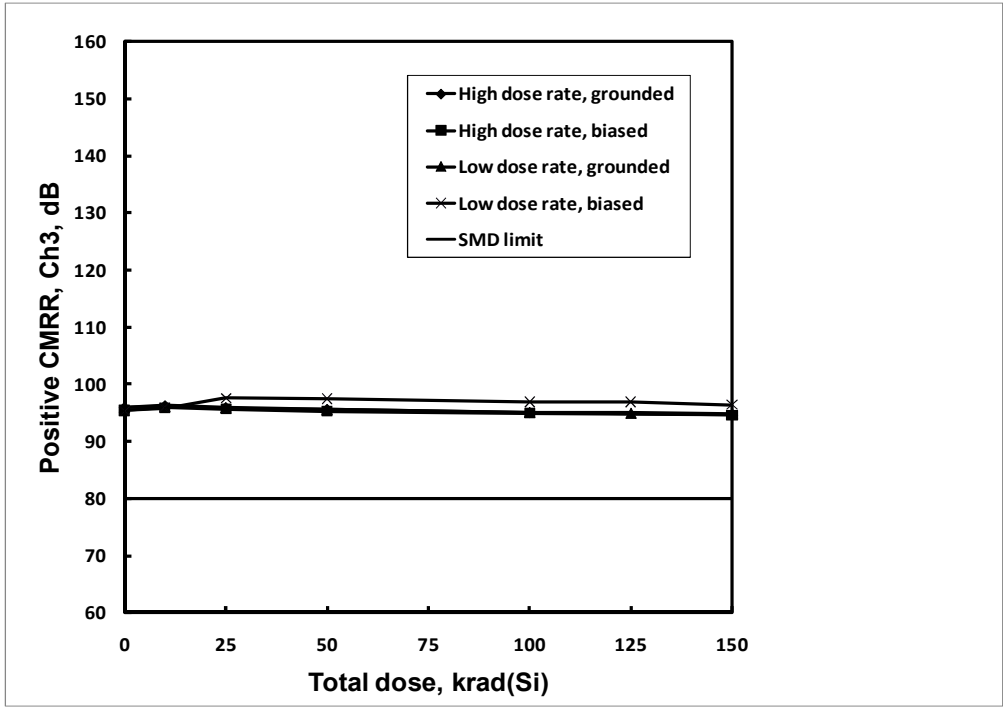

Fig. 30: HS-OP470ARH positive common-mode rejection ratio, channel 3, as a function of total dose irradiation at low and high dose rate for the unbiased and biased cases. The post-irradiation SMD limit is 80dB minimum.

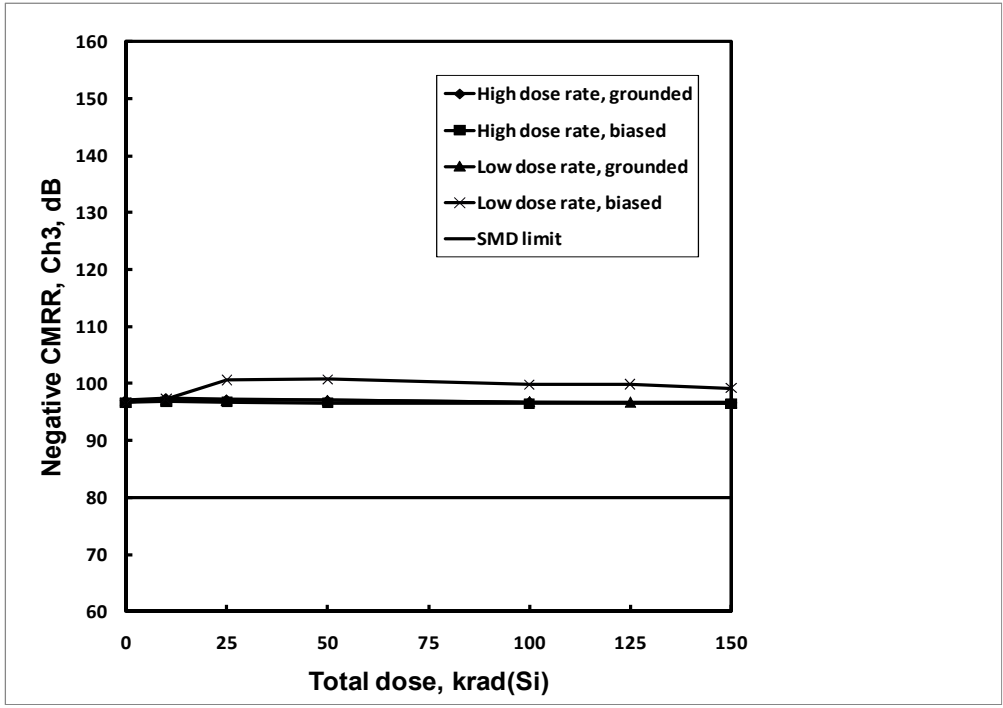

Fig. 31: HS-OP470ARH negative common-mode rejection ratio, channel 3, as a function of total dose irradiation at low and high dose rate for the unbiased and biased cases. The post-irradiation SMD limit is 80dB minimum.

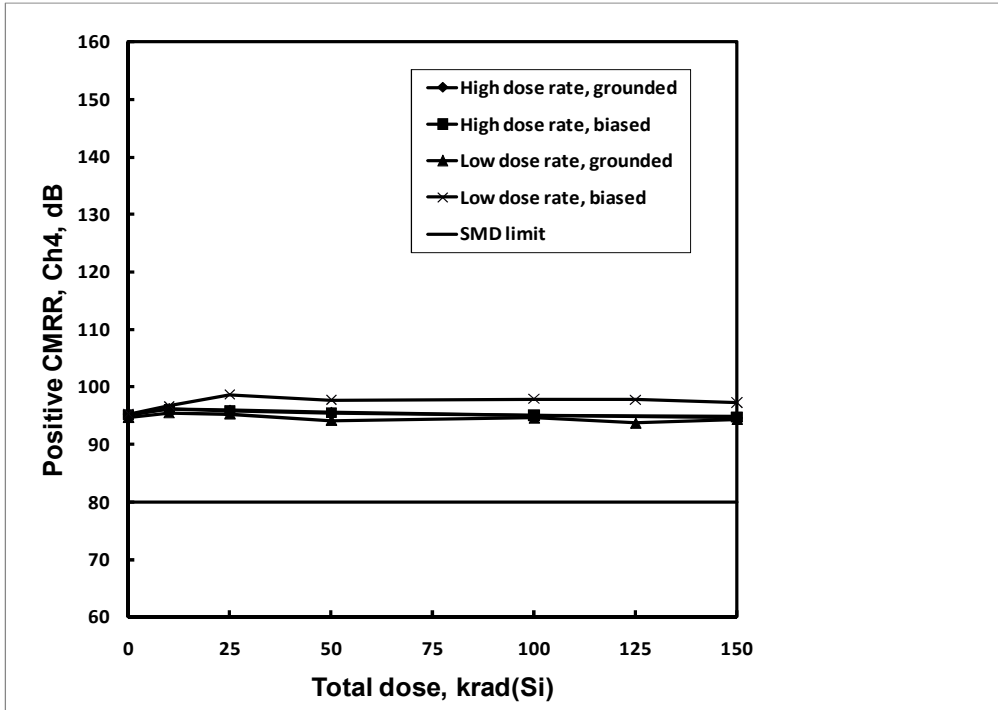

Fig. 32: HS-OP470ARH positive common-mode rejection ratio, channel 4, as a function of total dose irradiation at low and high dose rate for the unbiased and biased cases. The post-irradiation SMD limit is 80dB minimum.

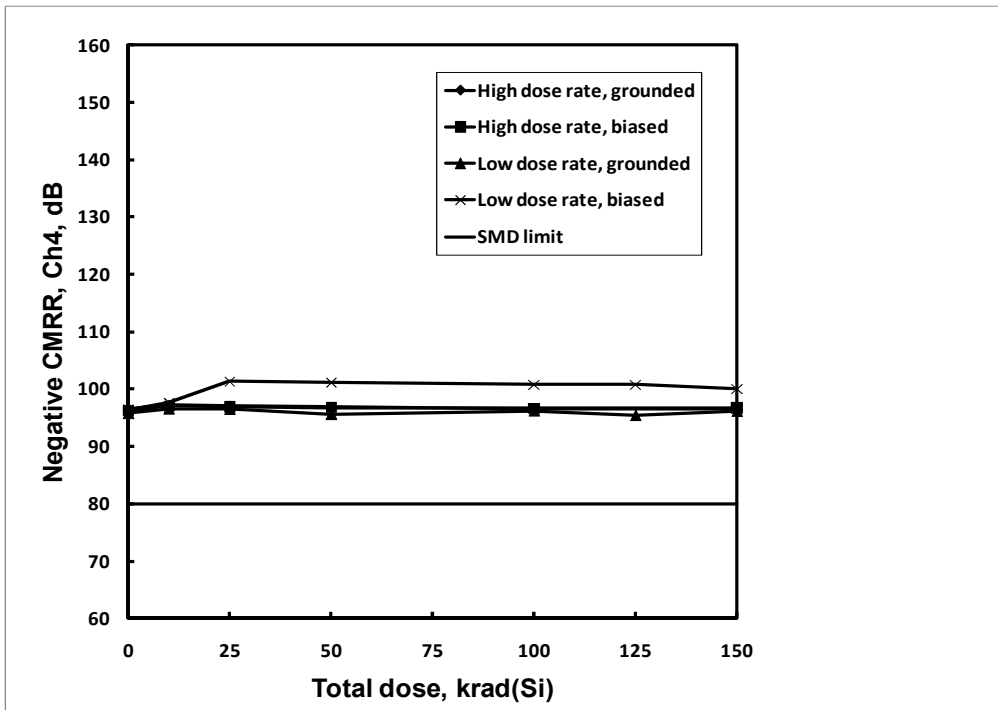

Fig. 33: HS-OP470ARH negative common-mode rejection ratio, channel 4, as a function of total dose irradiation at low and high dose rate for the unbiased and biased cases. The post-irradiation SMD limit is 80dB minimum.

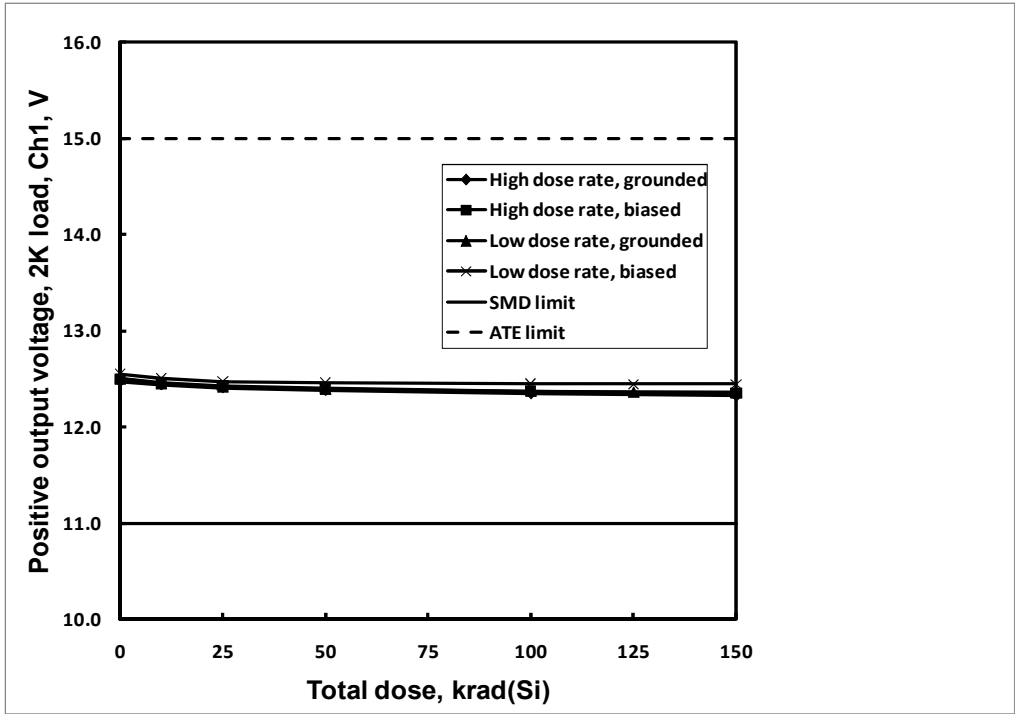

Fig. 34: HS-OP470ARH positive output voltage swing, 2K load, channel 1, as a function of total dose irradiation at low and high dose rate for the unbiased and biased cases. The post-irradiation SMD limit is 11V minimum. The 15V bound is an ATE limit.

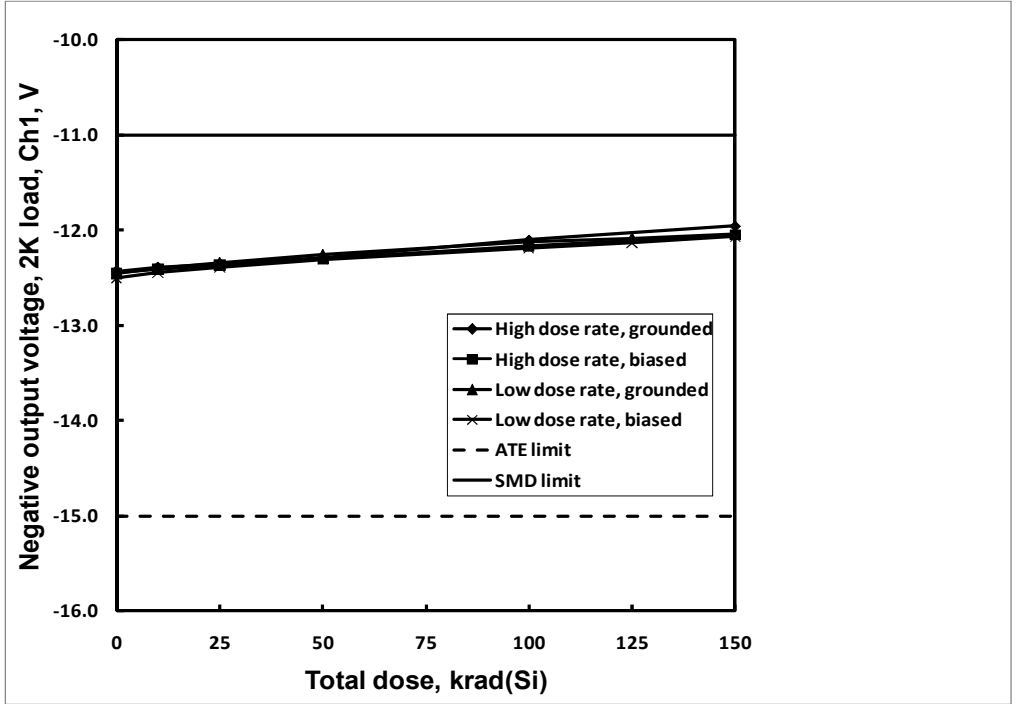
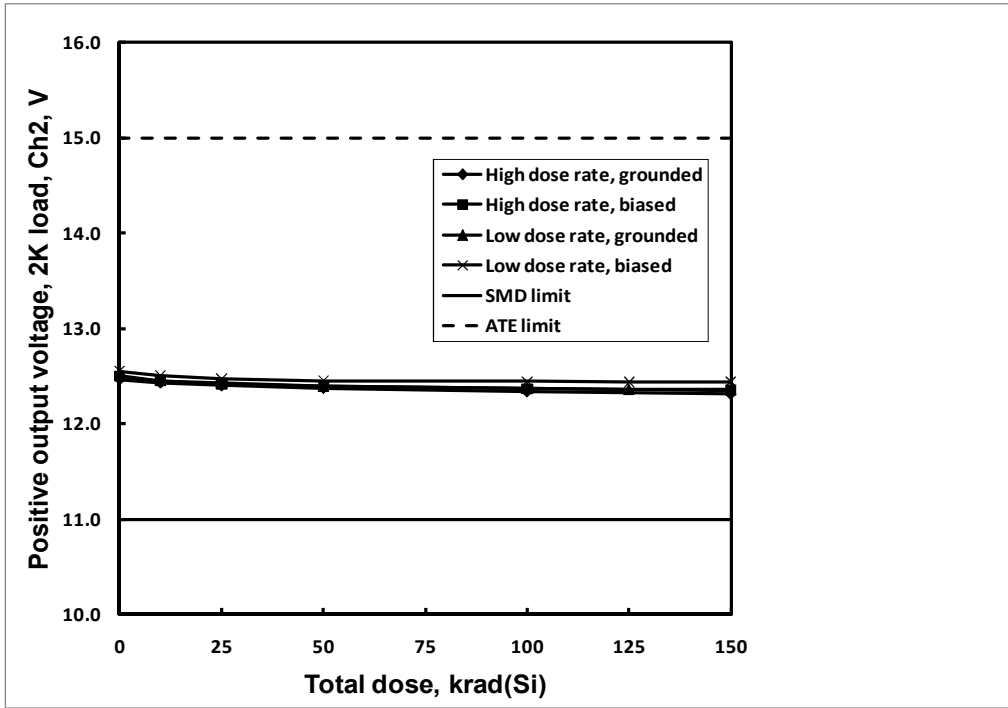
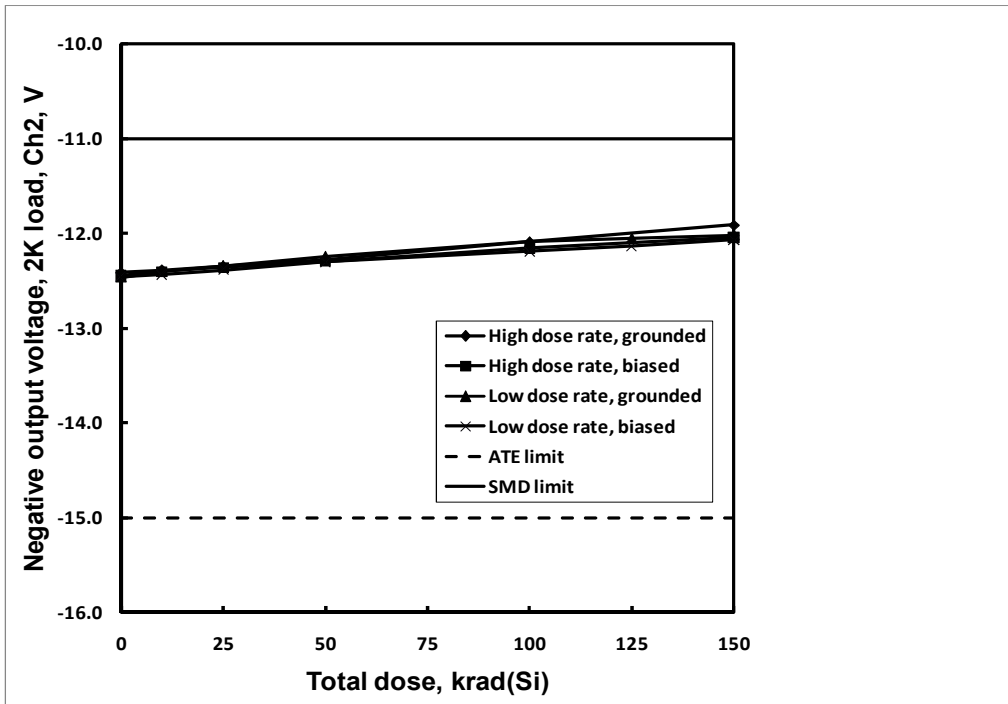

Fig. 35: HS-OP470ARH negative output voltage swing, 2K load, channel 1, as a function of total dose irradiation at low and high dose rate for the unbiased and biased cases. The post-irradiation SMD limit is -11V minimum. The -15V bound is an ATE limit.



**Fig. 36:** HS-OP470ARH positive output voltage swing, 2K load, channel 2, as a function of total dose irradiation at low and high dose rate for the unbiased and biased cases. The post-irradiation SMD limit is 11V minimum. The 15V bound is an ATE limit.



**Fig. 37:** HS-OP470ARH negative output voltage swing, 2K load, channel 2, as a function of total dose irradiation at low and high dose rate for the unbiased and biased cases. The post-irradiation SMD limit is -11V minimum. The -15V bound is an ATE limit.

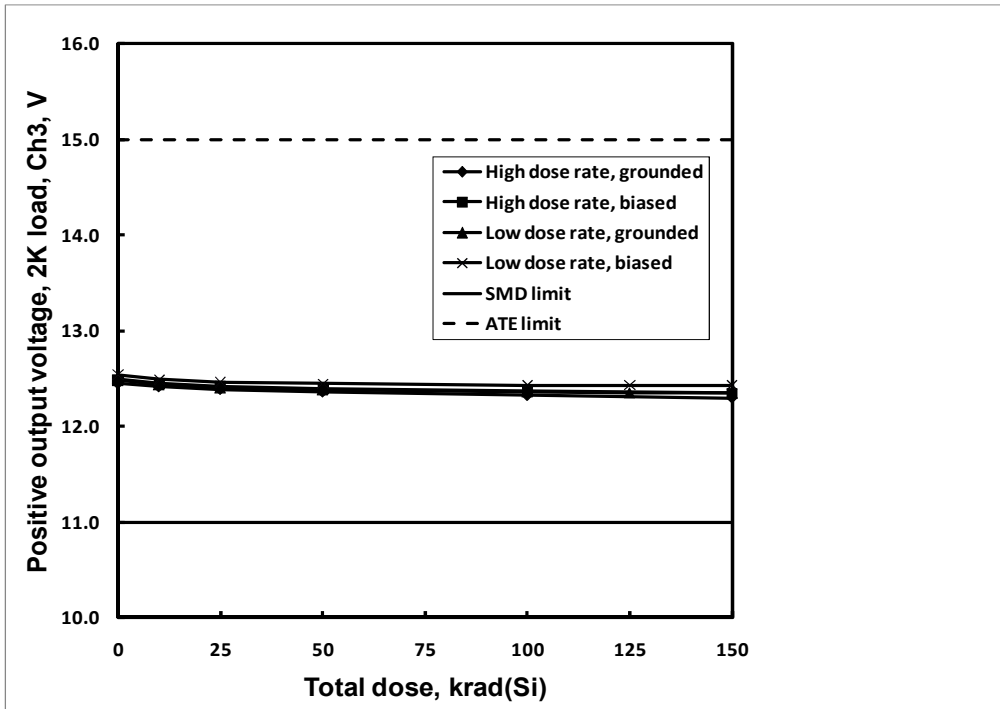

Fig. 38: HS-OP470ARH positive output voltage swing, 2K load, channel 3, as a function of total dose irradiation at low and high dose rate for the unbiased and biased cases. The post-irradiation SMD limit is 11V minimum. The 15V bound is an ATE limit.

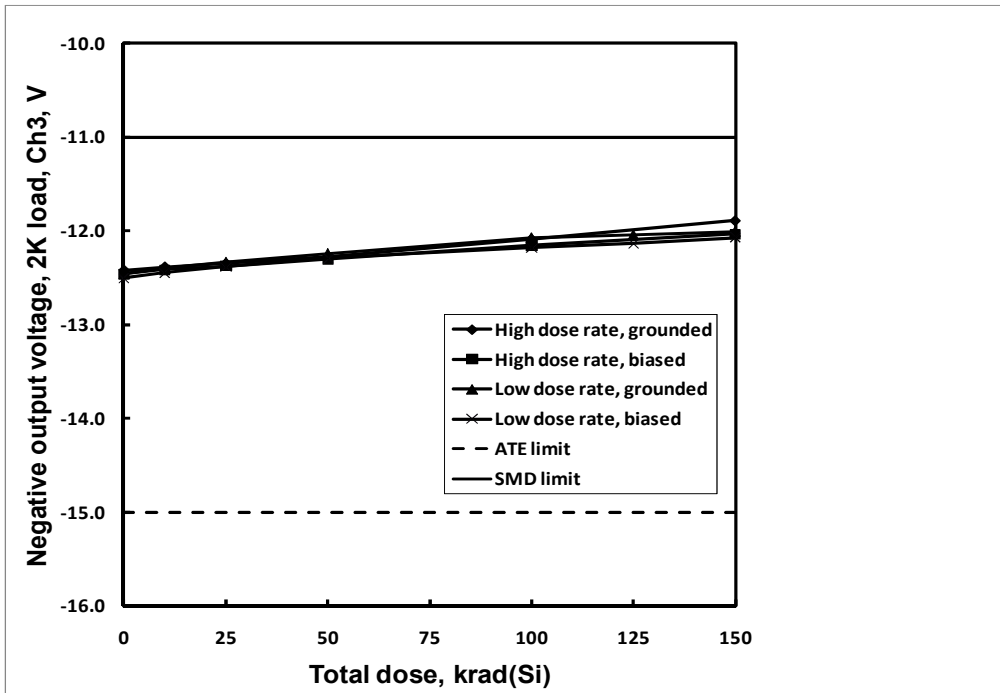

Fig. 39: HS-OP470ARH negative output voltage swing, 2K load, channel 3, as a function of total dose irradiation at low and high dose rate for the unbiased and biased cases. The post-irradiation SMD limit is -11V minimum. The -15V bound is an ATE limit.

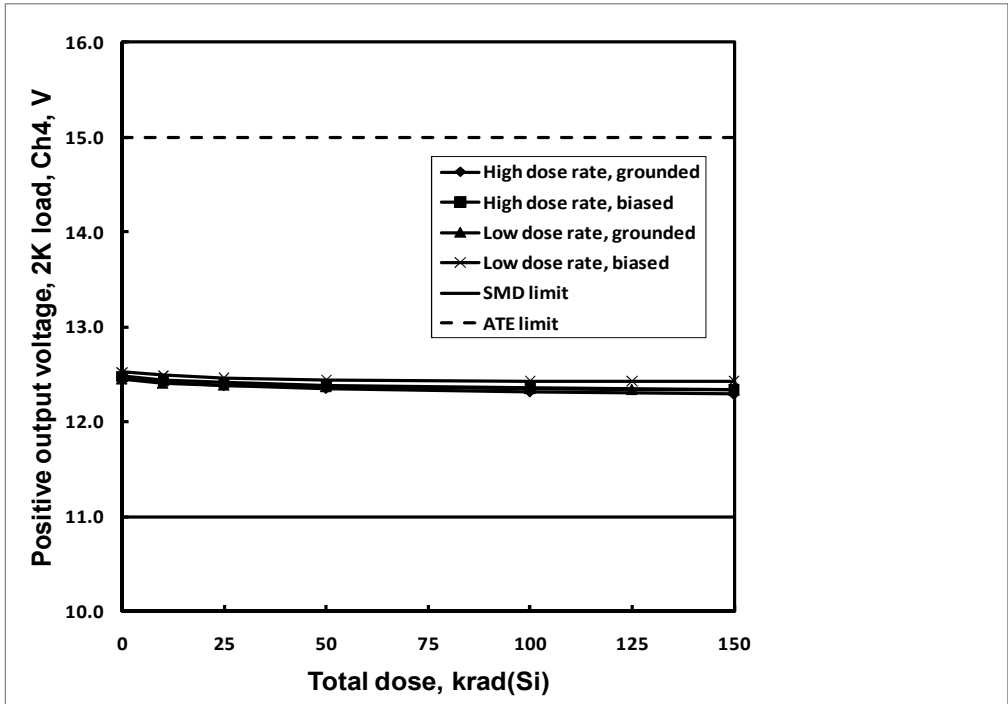

Fig. 40: HS-OP470ARH positive output voltage swing, 2K load, channel 4, as a function of total dose irradiation at low and high dose rate for the unbiased and biased cases. The post-irradiation SMD limit is 11V minimum. The 15V bound is an ATE limit.

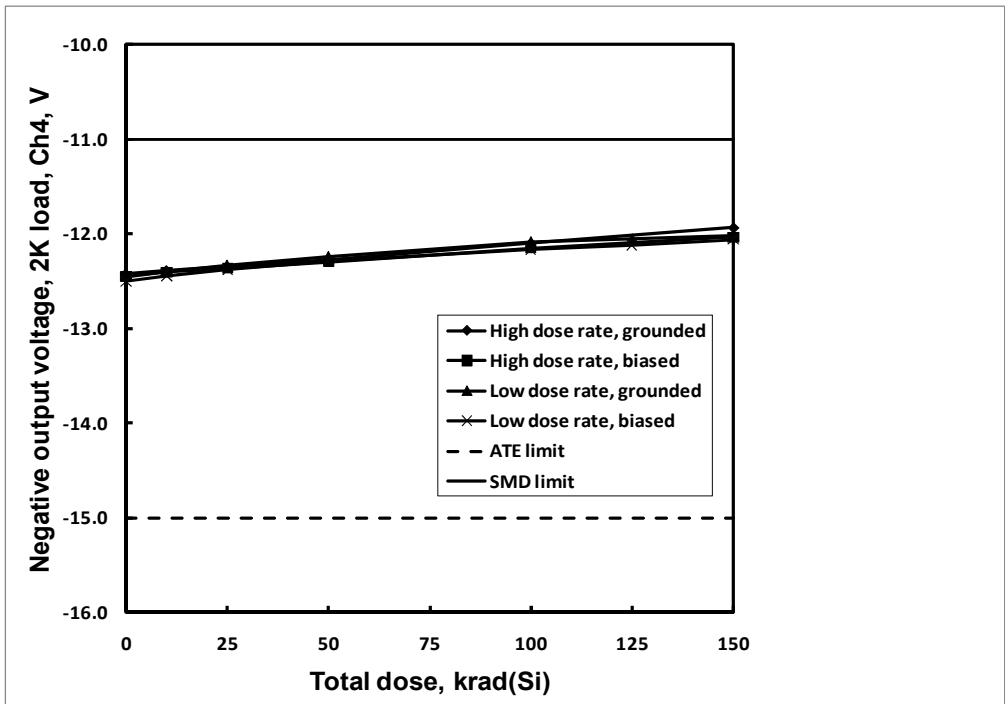

Fig. 41: HS-OP470ARH negative output voltage swing, 2K load, channel 4, as a function of total dose irradiation at low and high dose rate for the unbiased and biased cases. The post-irradiation SMD limit is -11V minimum. The -15V bound is an ATE limit.



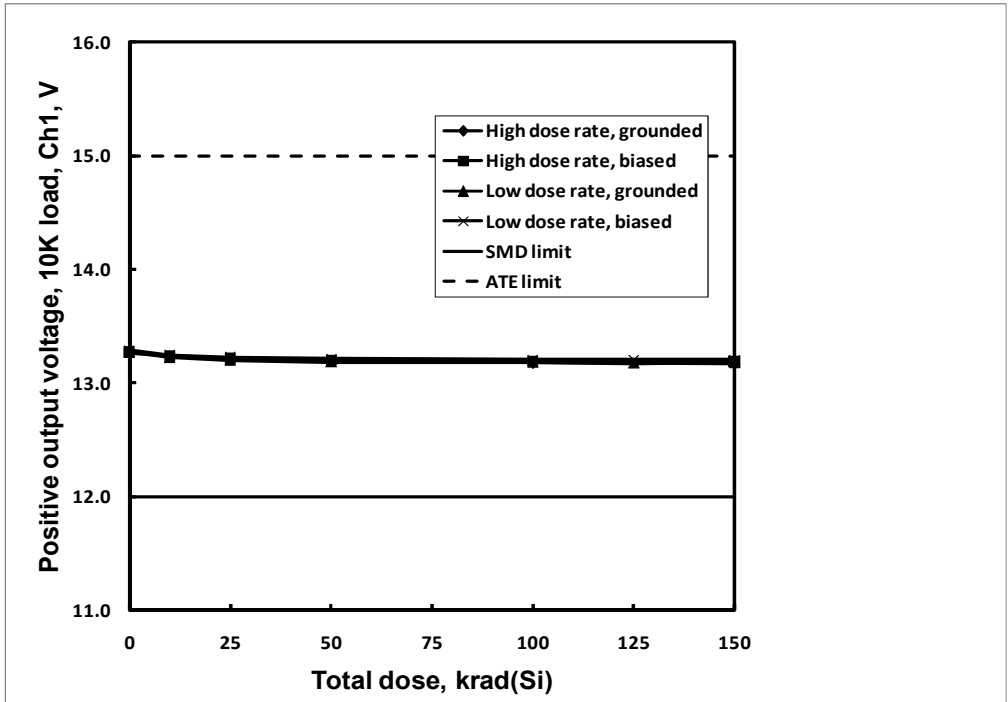

Fig. 42: HS-OP470ARH positive output voltage swing, 10K load, channel 1, as a function of total dose irradiation at low and high dose rate for the unbiased and biased cases. The post-irradiation SMD limit is 12V minimum. The 15V bound is an ATE limit.

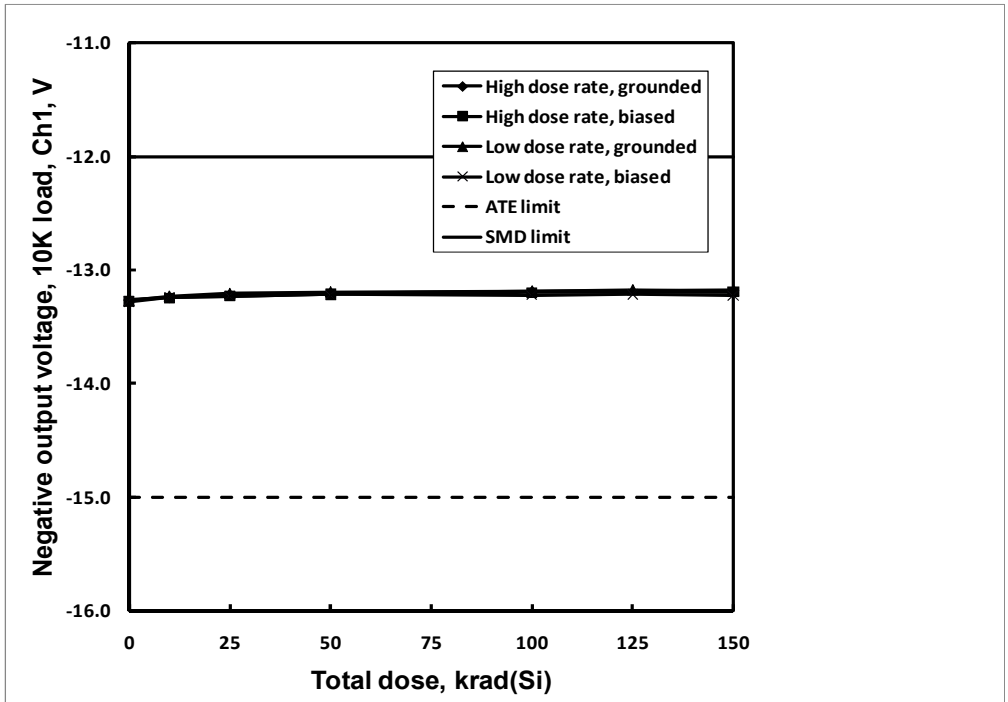

Fig. 43: HS-OP470ARH negative output voltage swing, 10K load, channel 1, as a function of total dose irradiation at low and high dose rate for the unbiased and biased cases. The post-irradiation SMD limit is -12V minimum. The -15V bound is an ATE limit.

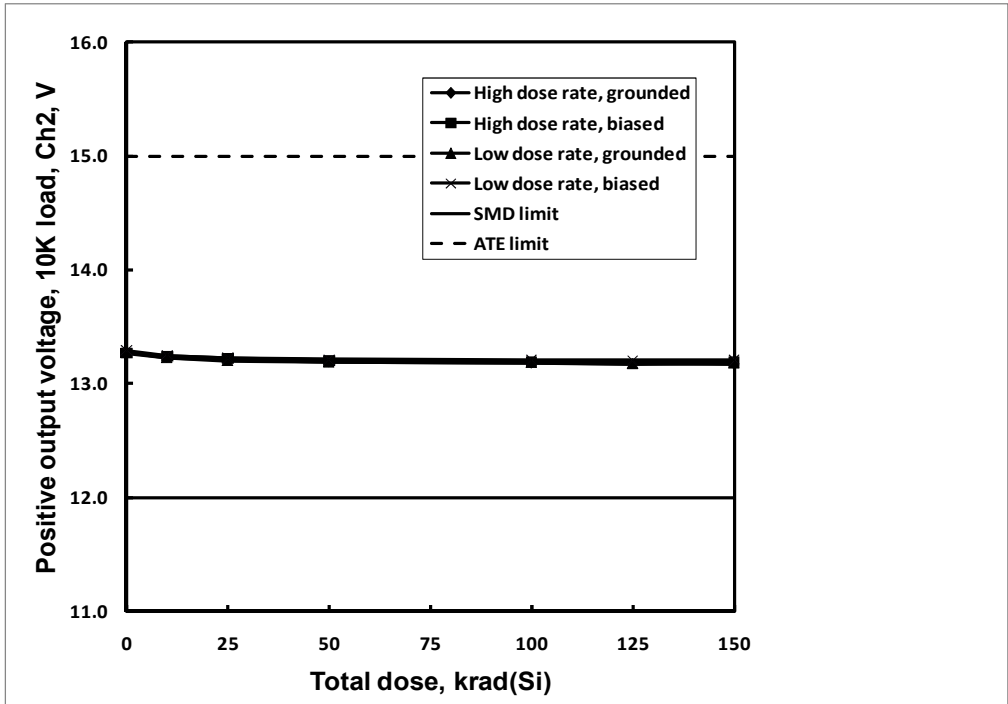

Fig. 44: HS-OP470ARH positive output voltage swing, 10K load, channel 2, as a function of total dose irradiation at low and high dose rate for the unbiased and biased cases. The post-irradiation SMD limit is 12V minimum. The 15V bound is an ATE limit.

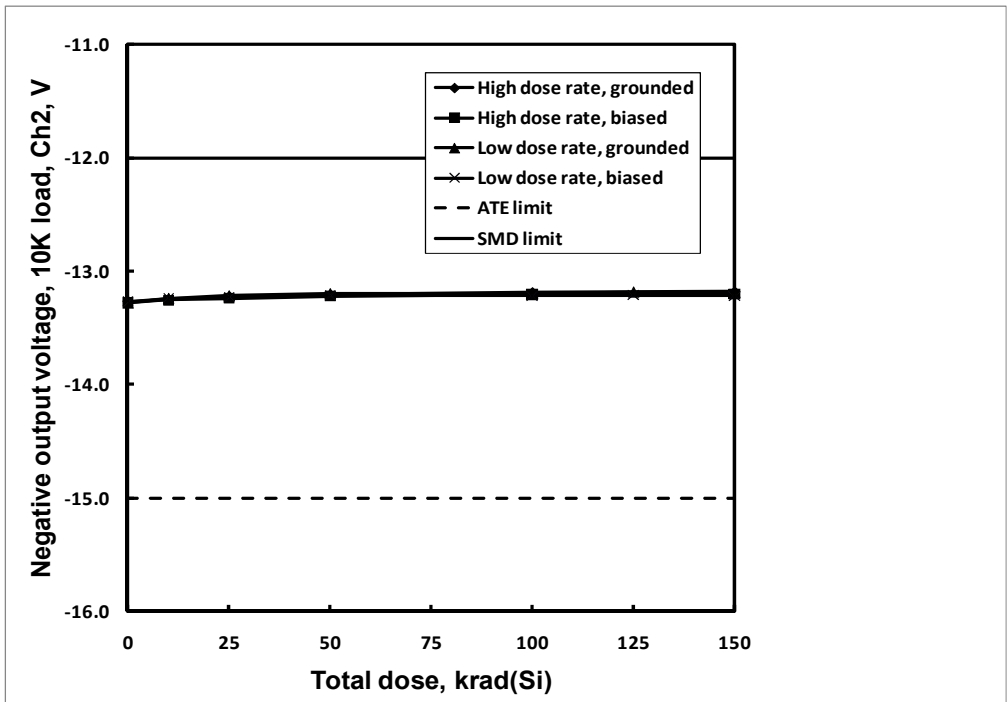

Fig. 45: HS-OP470ARH negative output voltage swing, 10K load, channel 2, as a function of total dose irradiation at low and high dose rate for the unbiased and biased cases. The post-irradiation SMD limit is -12V minimum. The -15V bound is an ATE limit.

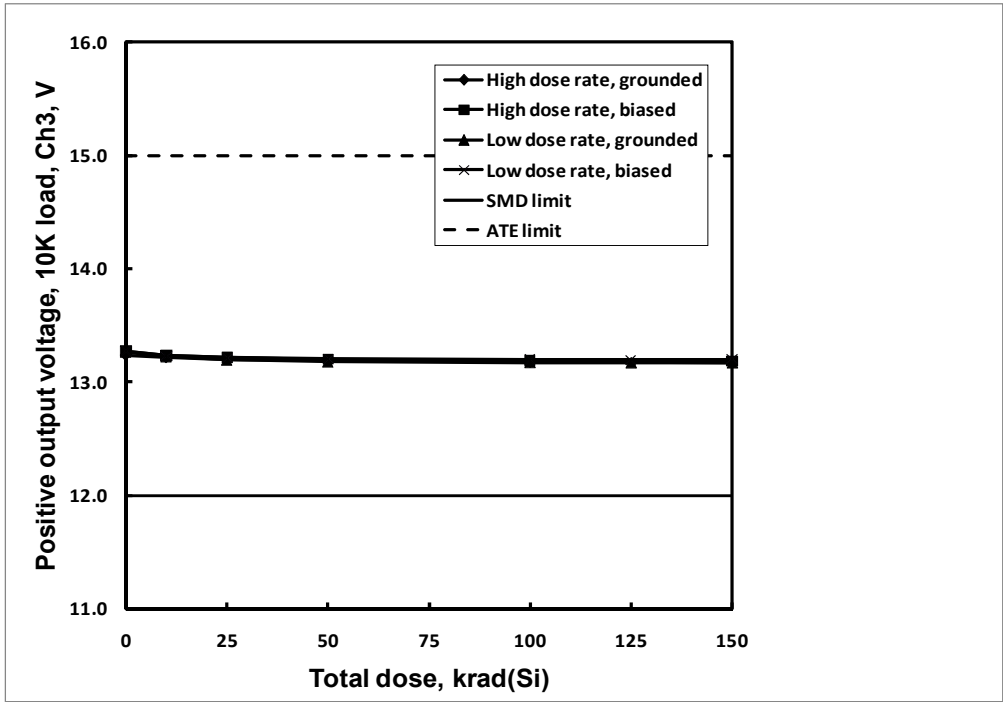

Fig. 46: HS-OP470ARH positive output voltage swing, 10K load, channel 3, as a function of total dose irradiation at low and high dose rate for the unbiased and biased cases. The post-irradiation SMD limit is 12V minimum. The 15V bound is an ATE limit.

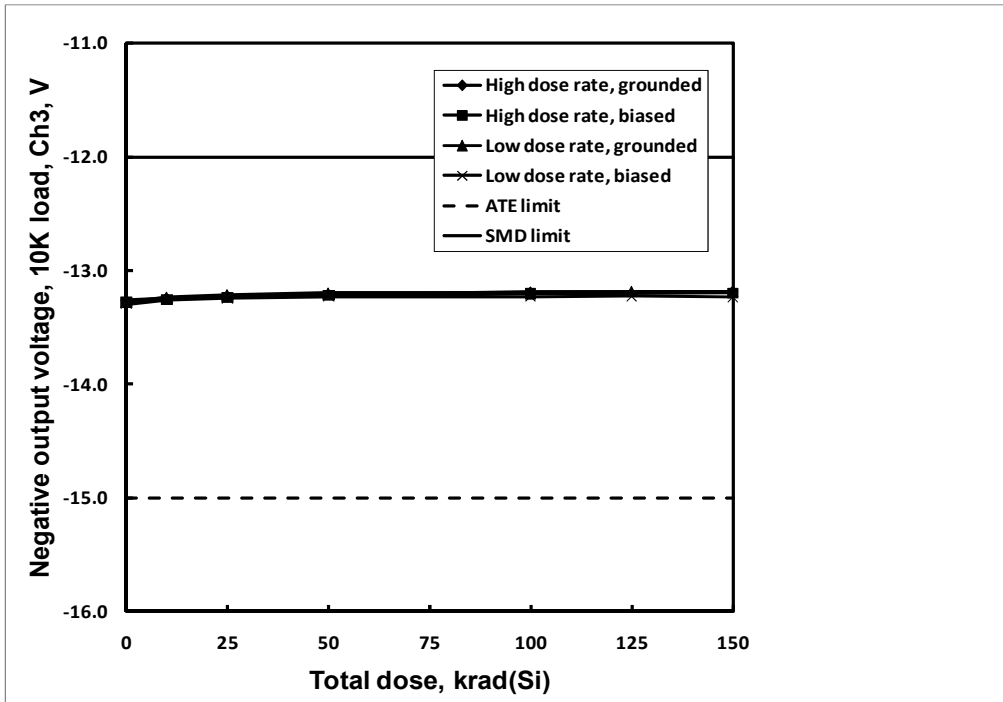

Fig. 47: HS-OP470ARH negative output voltage swing, 10K load, channel 3, as a function of total dose irradiation at low and high dose rate for the unbiased and biased cases. The post-irradiation SMD limit is -12V minimum. The -15V bound is an ATE limit.

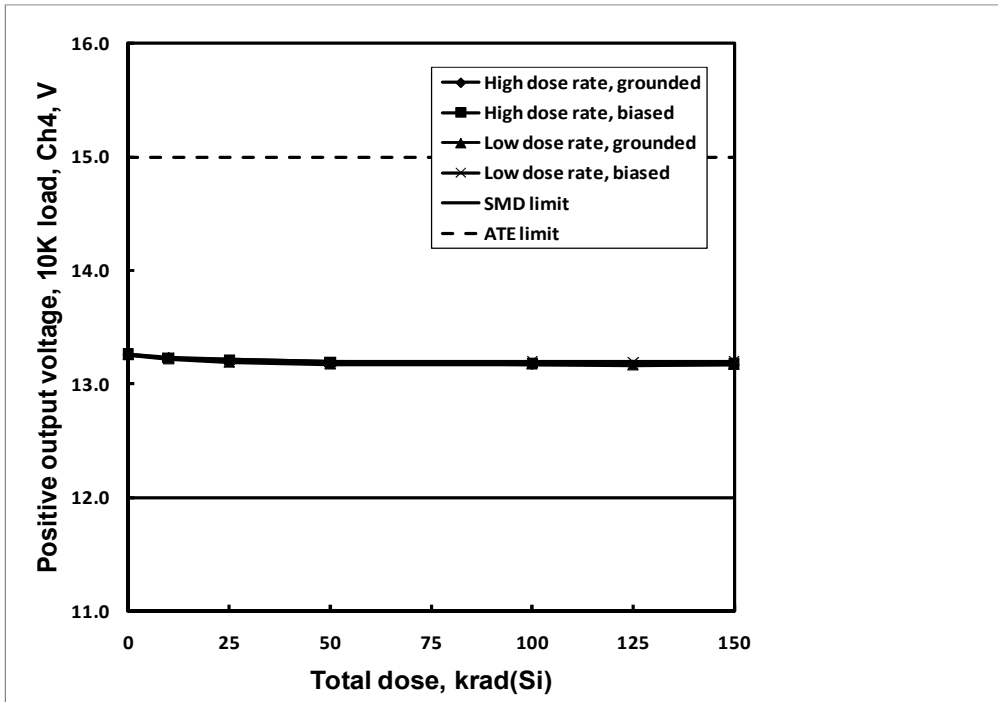

Fig. 48: HS-OP470ARH positive output voltage swing, 10K load, channel 4, as a function of total dose irradiation at low and high dose rate for the unbiased and biased cases. The post-irradiation SMD limit is 12V minimum. The 15V bound is an ATE limit.

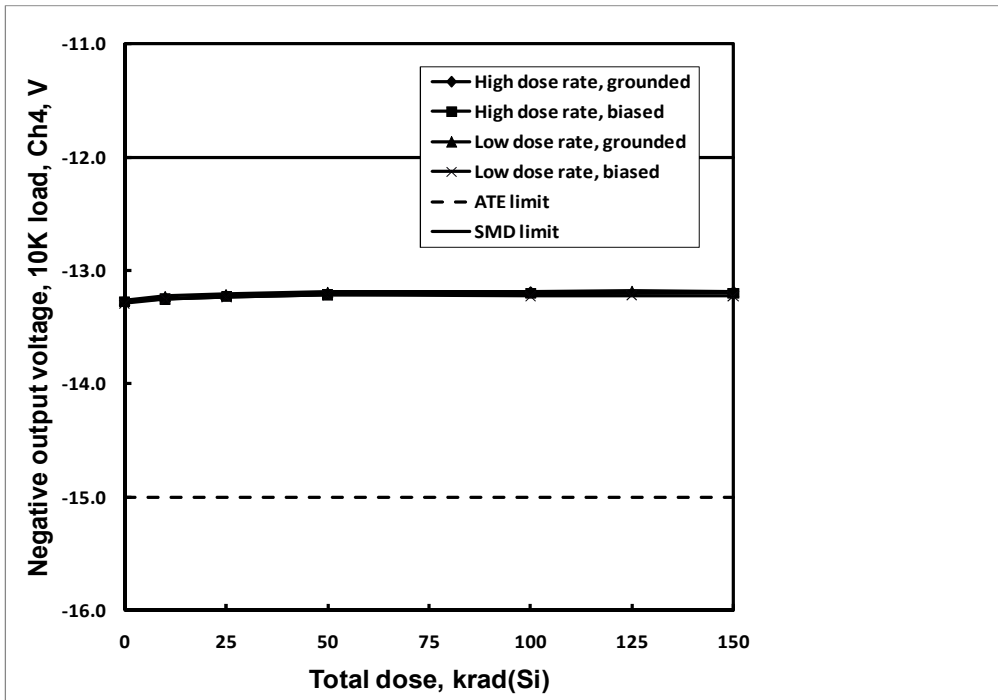

Fig. 49: HS-OP470ARH positive output voltage swing, 10K load, channel 4, as a function of total dose irradiation at low and high dose rate for the unbiased and biased cases. The post-irradiation SMD limit is -12V minimum. The -15V bound is an ATE limit.

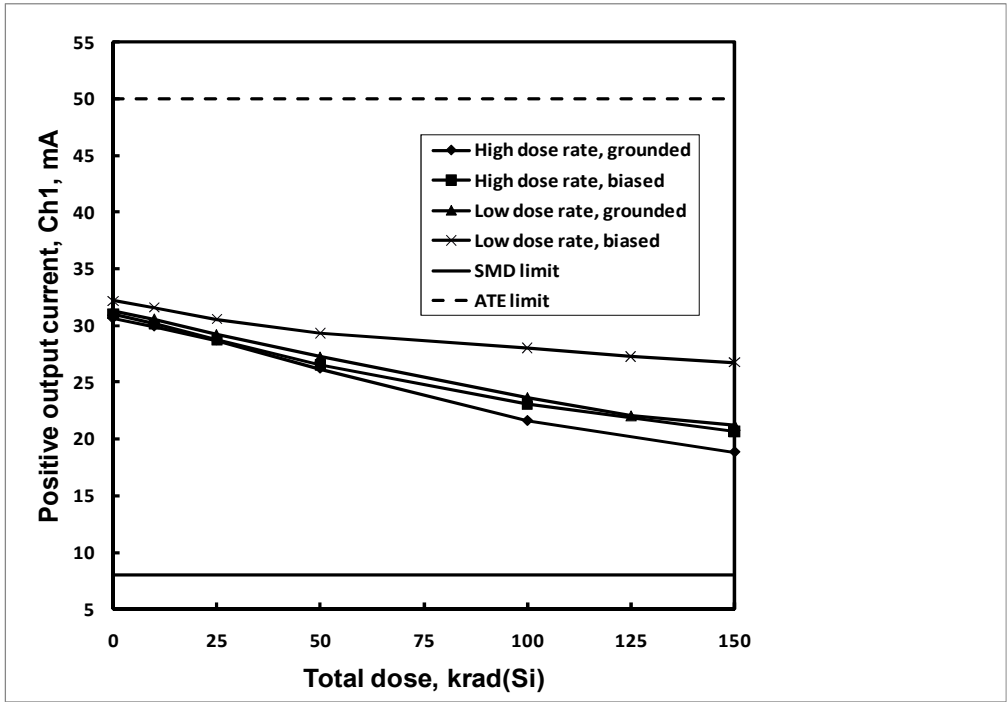

Fig. 50: HS-OP470ARH positive output current, channel 1, as a function of total dose irradiation at low and high dose rate for the unbiased and biased cases. The post-irradiation SMD limit is 8mA minimum. The 50mA bound is an ATE limit.

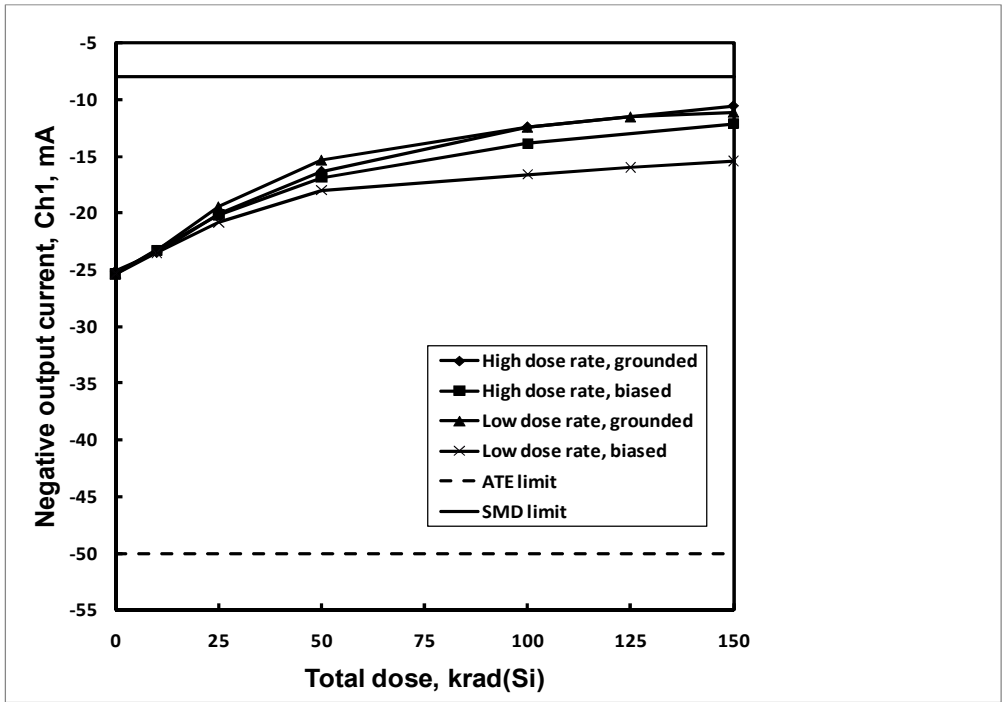

Fig. 51: HS-OP470ARH negative output current, channel 1, as a function of total dose irradiation at low and high dose rate for the unbiased and biased cases. The post-irradiation SMD limit is -8mA minimum. The -50mA bound is an ATE limit.

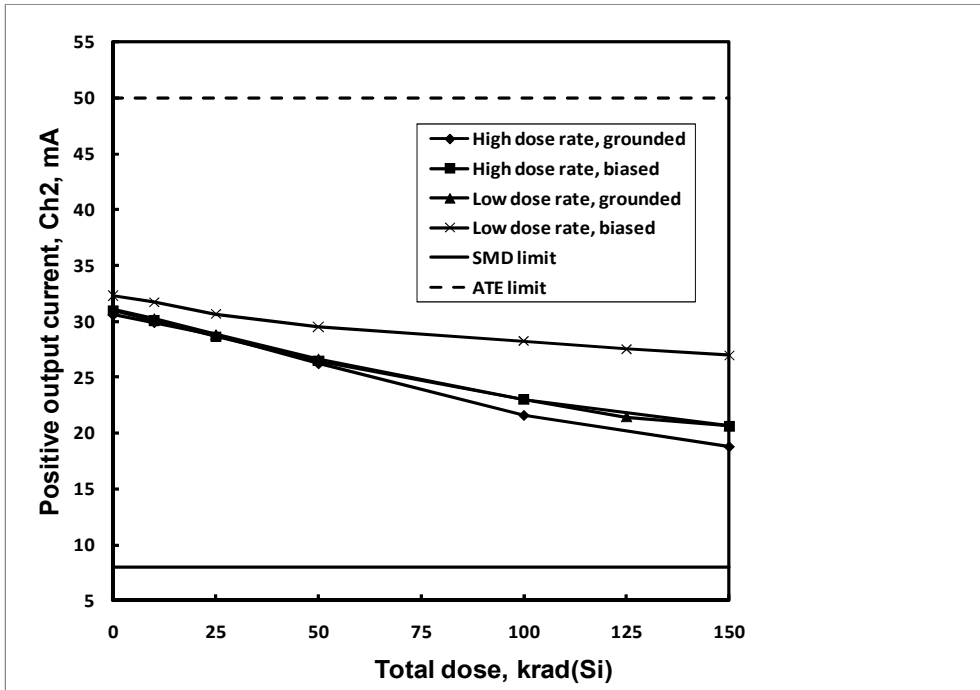

Fig. 52: HS-OP470ARH positive output current, channel 2, as a function of total dose irradiation at low and high dose rate for the unbiased and biased cases. The post-irradiation SMD limit is 8mA minimum. The 50mA bound is an ATE limit.

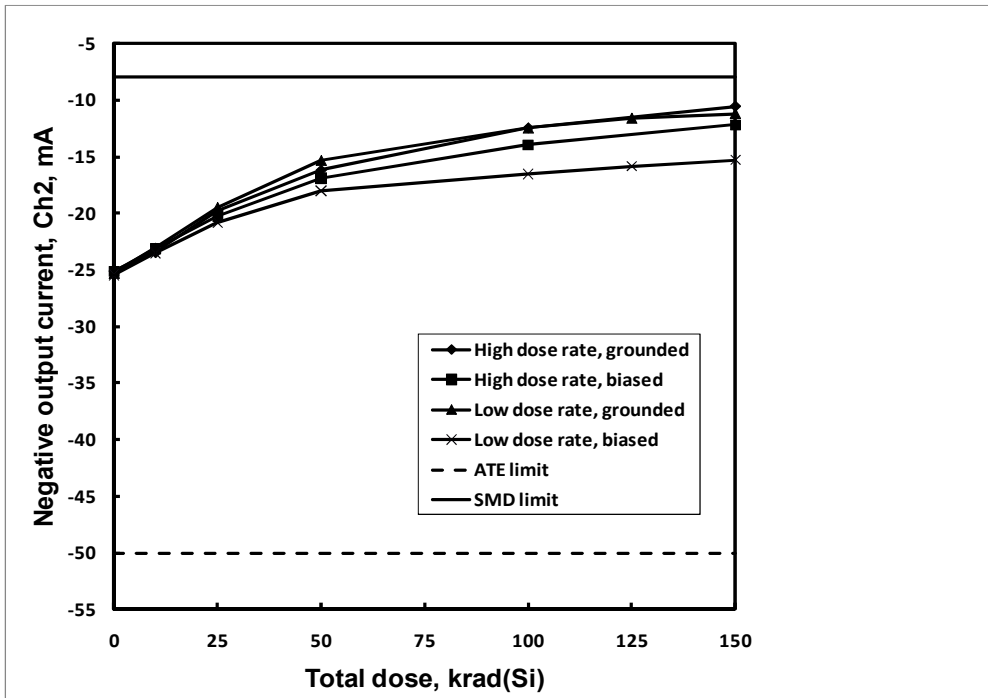

Fig. 53: HS-OP470ARH negative output current, channel 2, as a function of total dose irradiation at low and high dose rate for the unbiased and biased cases. The post-irradiation SMD limit is -8mA minimum. The -50mA bound is an ATE limit.

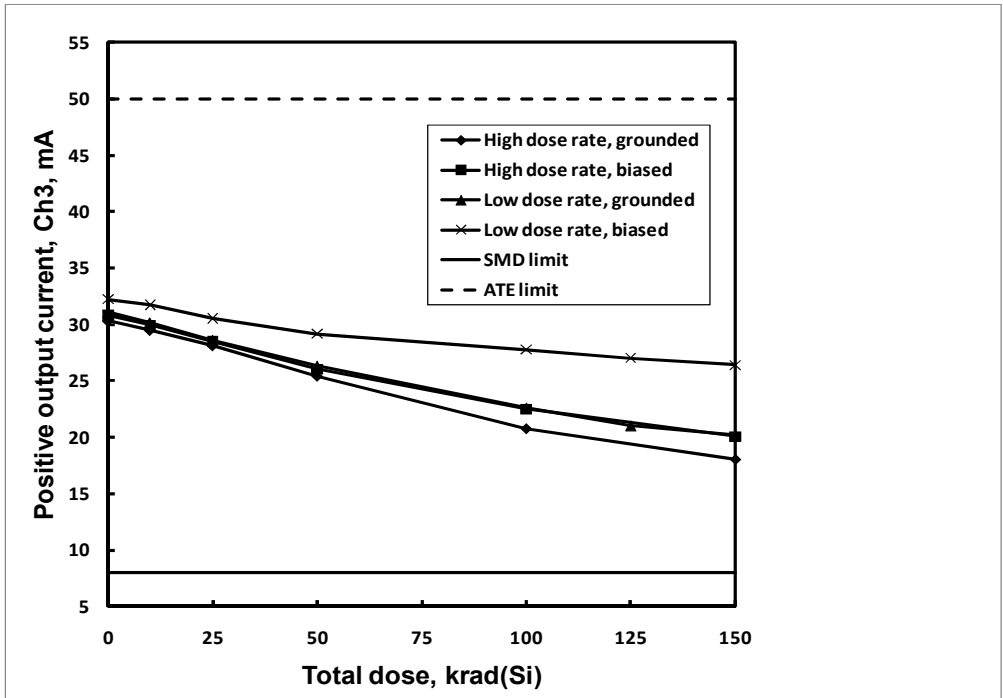

Fig. 54: HS-OP470ARH positive output current, channel 3, as a function of total dose irradiation at low and high dose rate for the unbiased and biased cases. The post-irradiation SMD limit is 8mA minimum. The 50mA bound is an ATE limit.

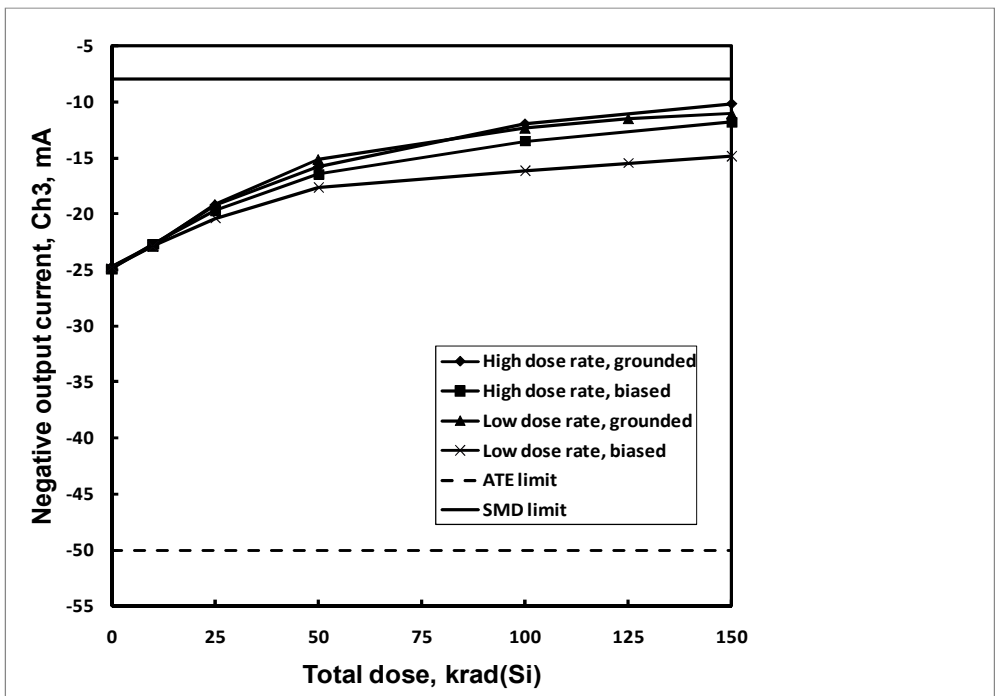

Fig. 55: HS-OP470ARH negative output current, channel 3, as a function of total dose irradiation at low and high dose rate for the unbiased and biased cases. The post-irradiation SMD limit is -8mA minimum. The -50mA bound is an ATE limit.

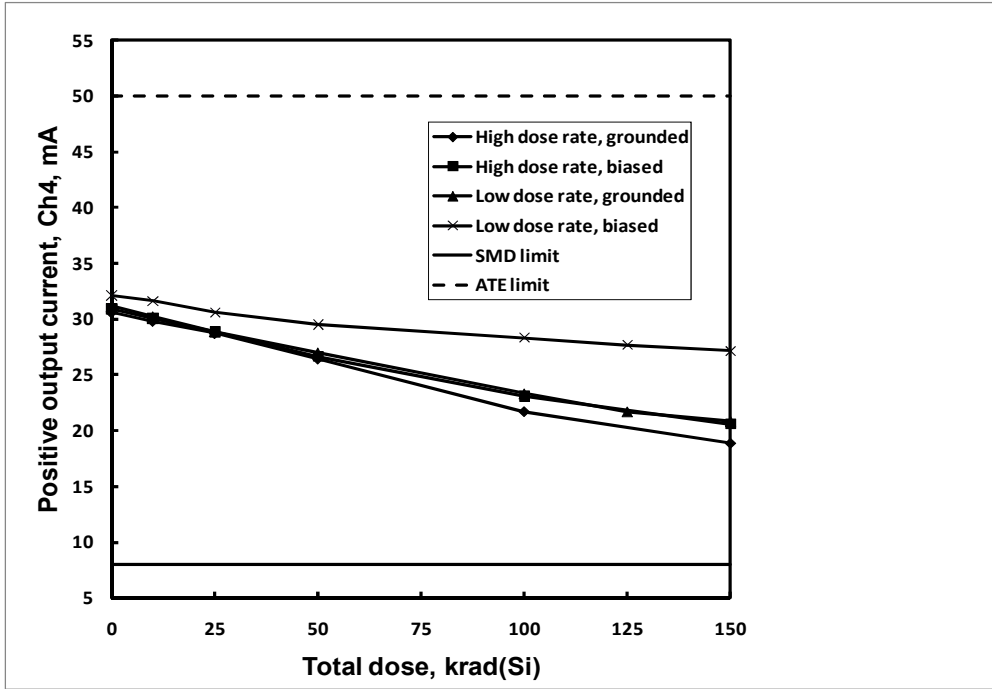

Fig. 56: HS-OP470ARH positive output current, channel 4, as a function of total dose irradiation at low and high dose rate for the unbiased and biased cases. The post-irradiation SMD limit is 8mA minimum. The 50mA bound is an ATE limit.

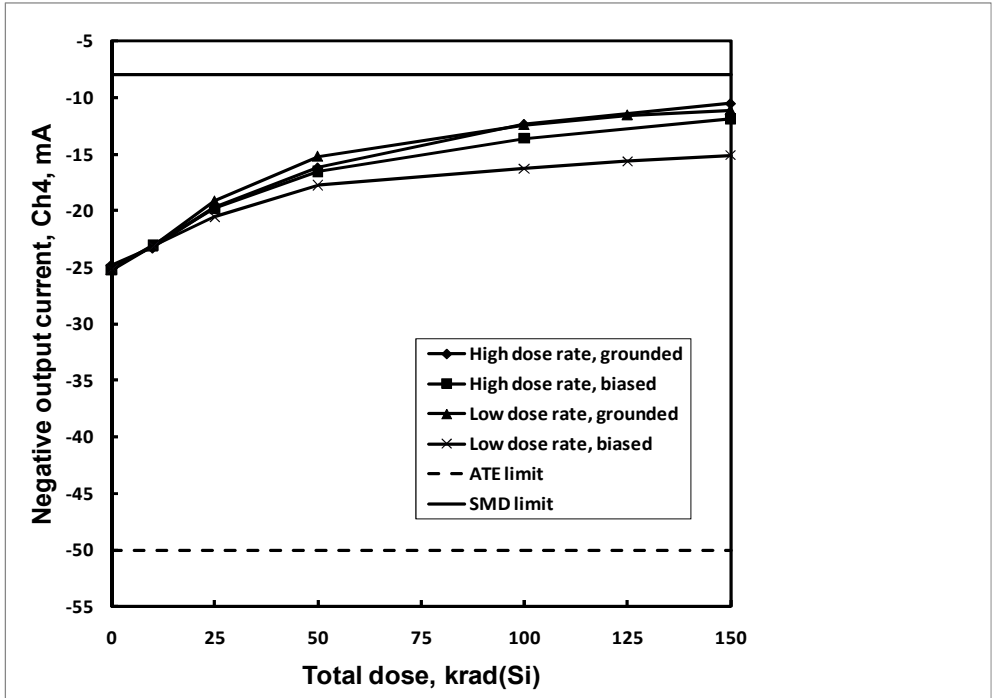
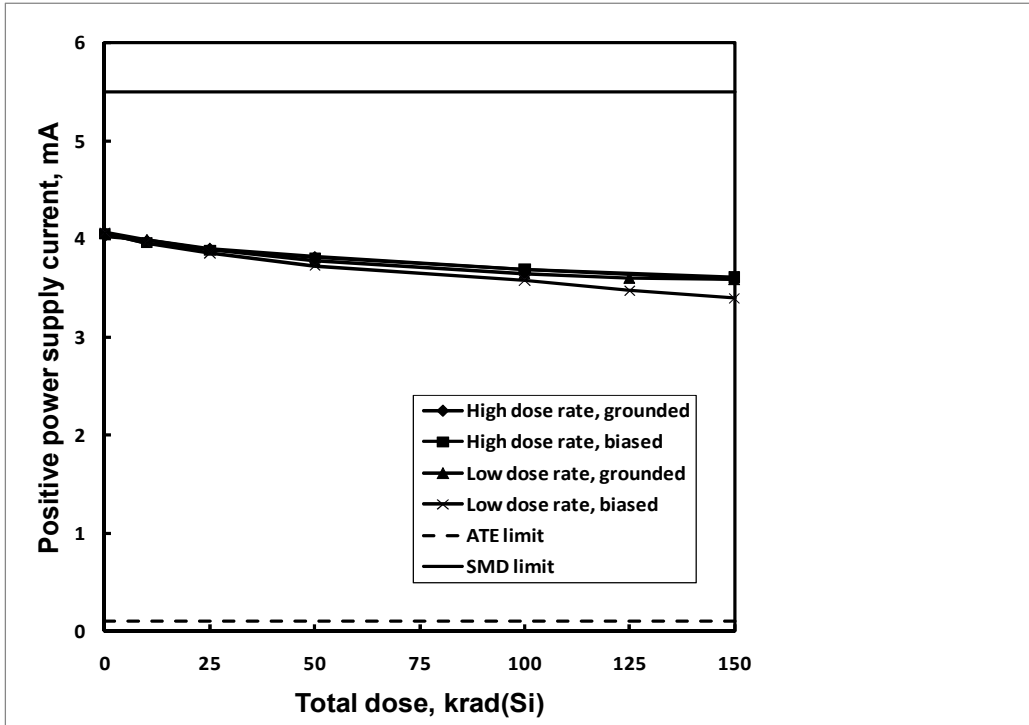
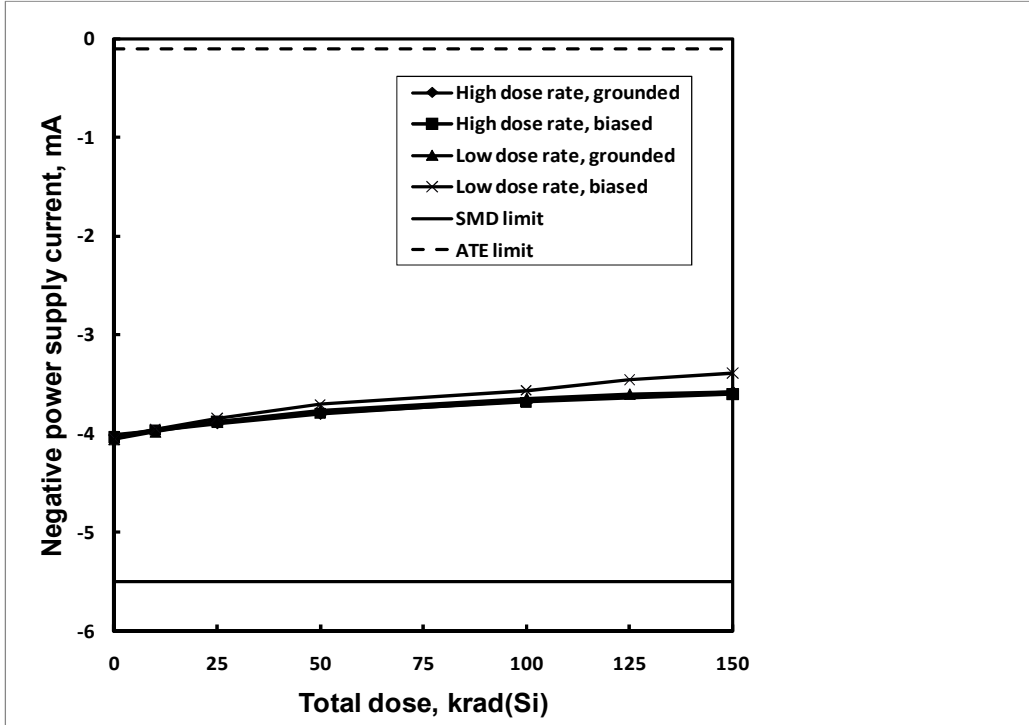

Fig. 57: HS-OP470ARH negative output current, channel 4, as a function of total dose irradiation at low and high dose rate for the unbiased and biased cases. The post-irradiation SMD limit is -8mA minimum. The -50mA bound is an ATE limit.





**Fig. 58:** HS-OP470ARH positive power supply current as a function of total dose irradiation at low and high dose rate for the unbiased and biased cases. The post-irradiation SMD limit is 5.5mA maximum. The 0.1mA bound is an ATE limit.



**Fig. 59:** HS-OP470ARH negative power supply current as a function of total dose irradiation at low and high dose rate for the unbiased and biased cases. The post-irradiation SMD limit is -5.5mA maximum. The -0.1mA bound is an ATE limit.

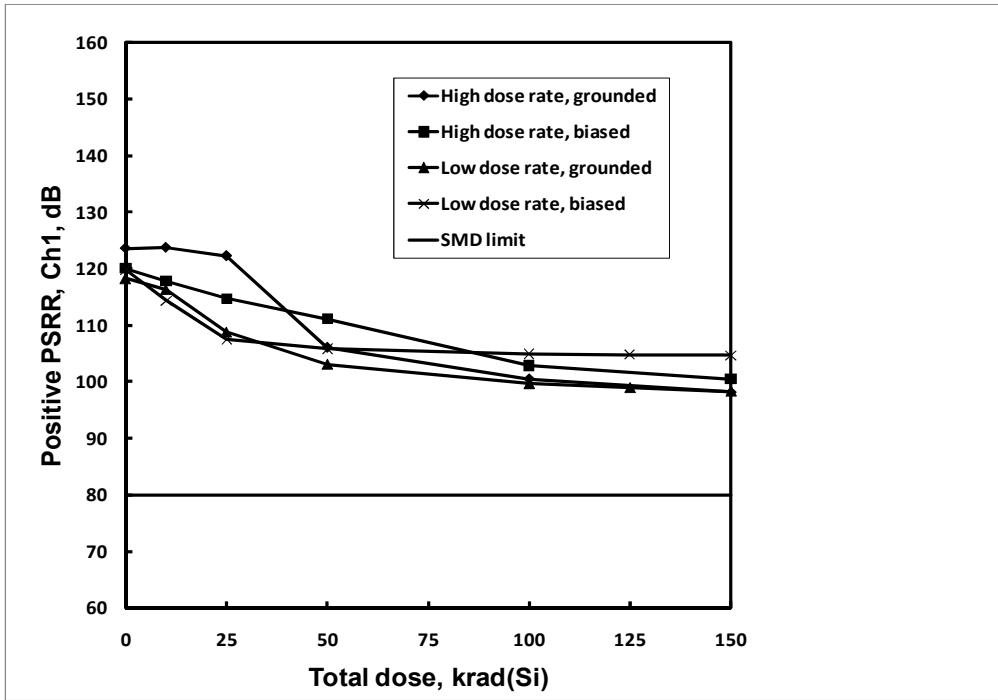

Fig. 60: HS-OP470ARH positive power supply rejection ratio, channel 1, as a function of total dose irradiation at low and high dose rate for the unbiased and biased cases. The post-irradiation SMD limit is 80dB minimum.

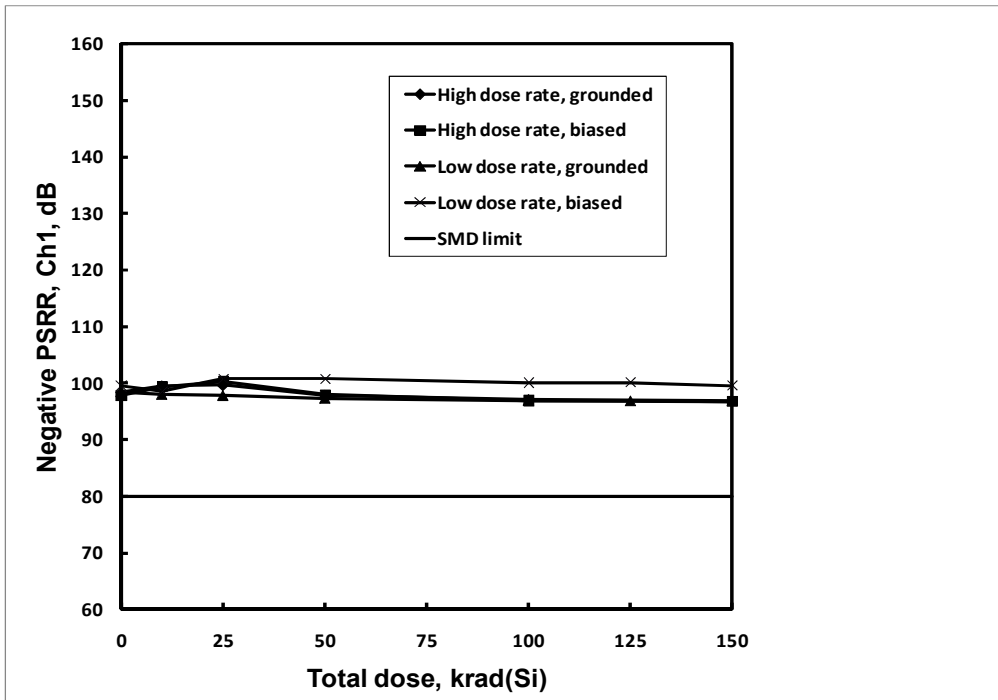
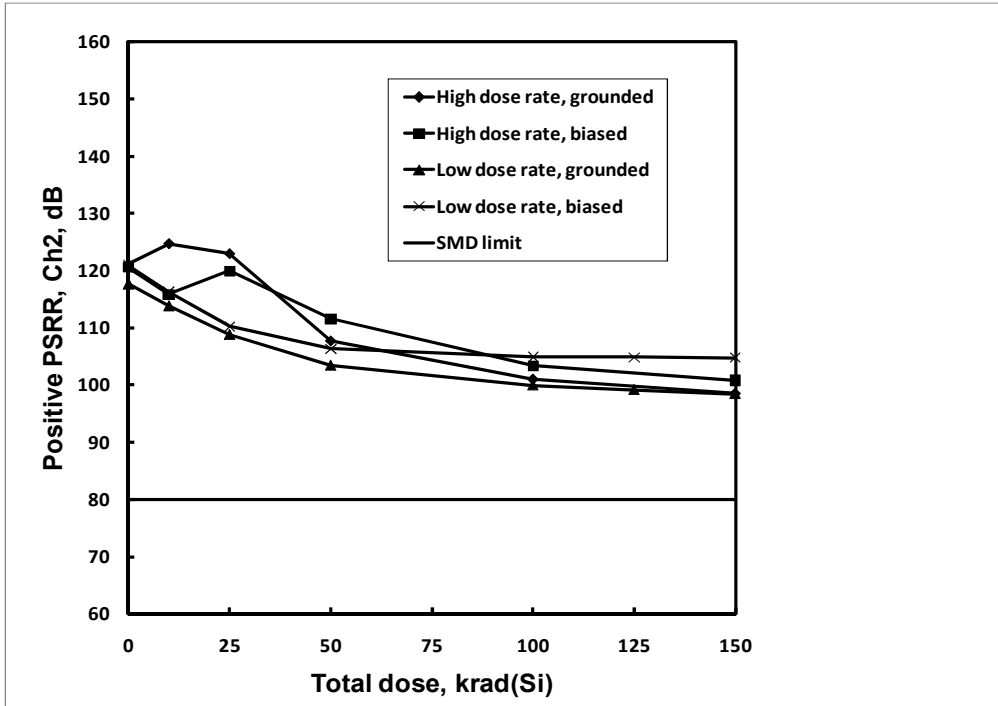
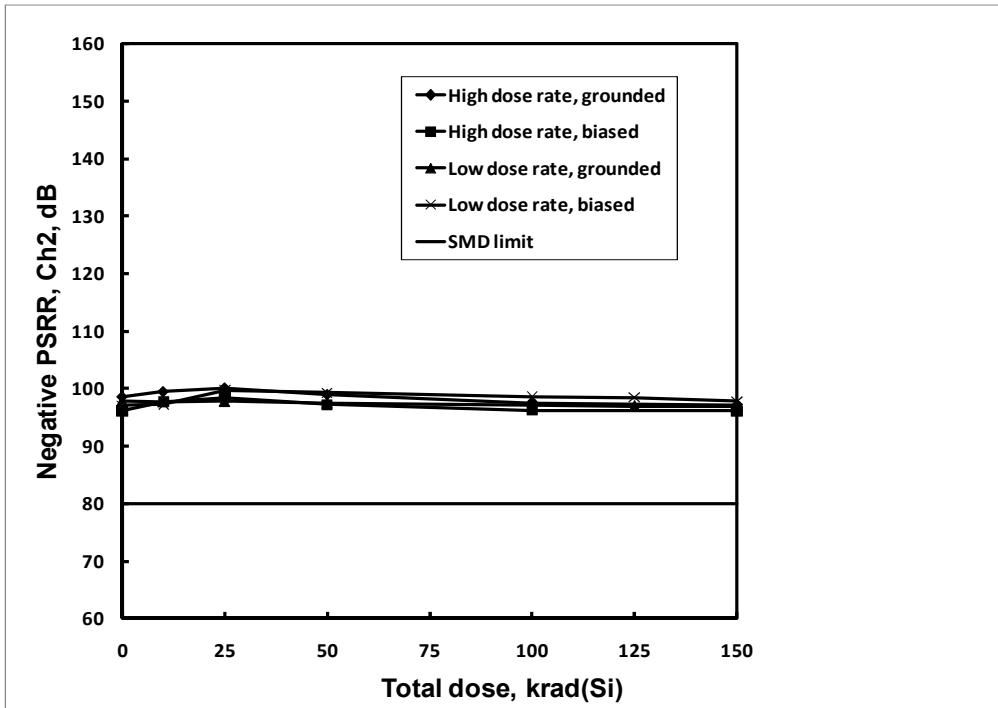

Fig. 61: HS-OP470ARH negative power supply rejection ratio, channel 1, as a function of total dose irradiation at low and high dose rate for the unbiased and biased cases. The post-irradiation SMD limit is 80dB minimum.



**Fig. 62:** HS-OP470ARH positive power supply rejection ratio, channel 2, as a function of total dose irradiation at low and high dose rate for the unbiased and biased cases. The post-irradiation SMD limit is 80dB minimum.



**Fig. 63:** HS-OP470ARH negative power supply rejection ratio, channel 2, as a function of total dose irradiation at low and high dose rate for the unbiased and biased cases. The post-irradiation SMD limit is 80dB minimum.

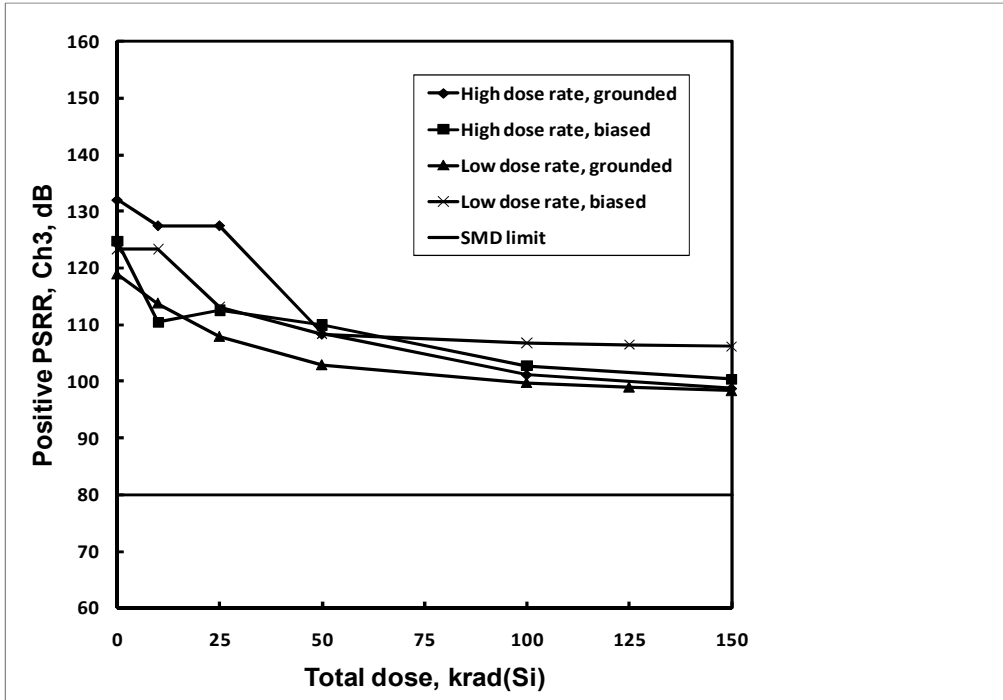

Fig. 64: HS-OP470ARH positive power supply rejection ratio, channel 3, as a function of total dose irradiation at low and high dose rate for the unbiased and biased cases. The post-irradiation SMD limit is 80dB minimum.

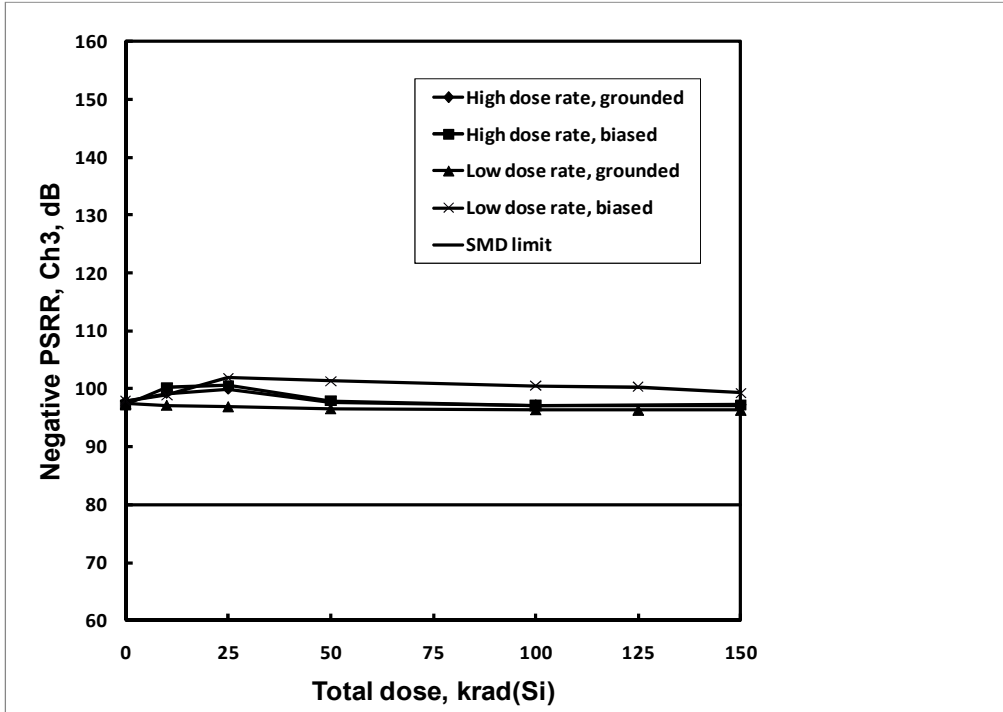

Fig. 65: HS-OP470ARH negative power supply rejection ratio, channel 3, as a function of total dose irradiation at low and high dose rate for the unbiased and biased cases. The post-irradiation SMD limit is 80dB minimum.

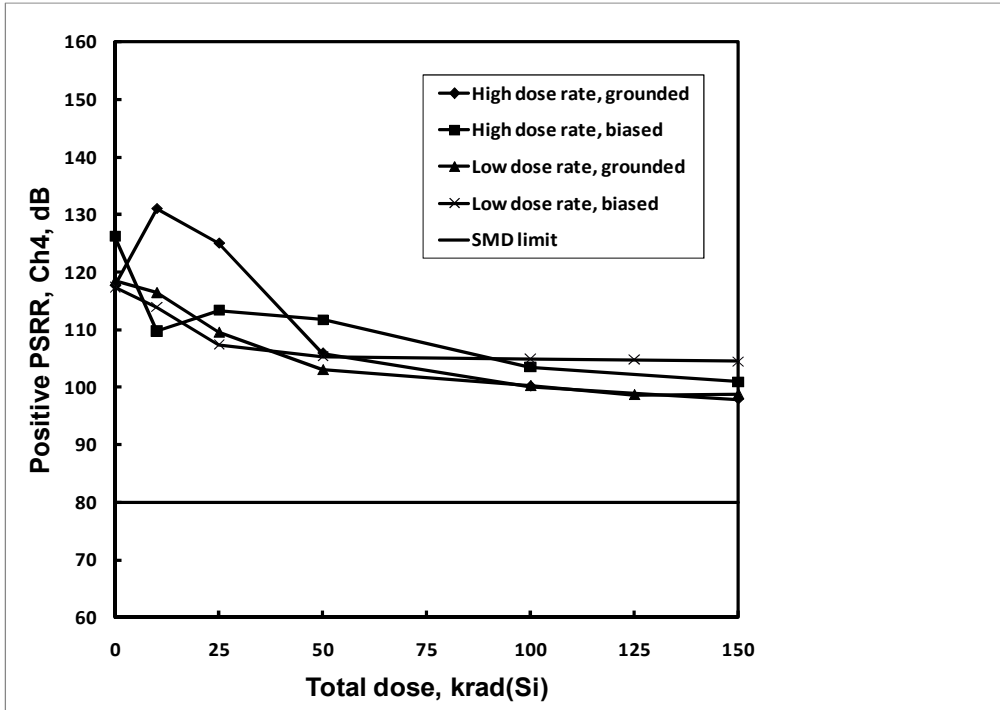

Fig. 66: HS-OP470ARH positive power supply rejection ratio, channel 4, as a function of total dose irradiation at low and high dose rate for the unbiased and biased cases. The post-irradiation SMD limit is 80dB minimum.

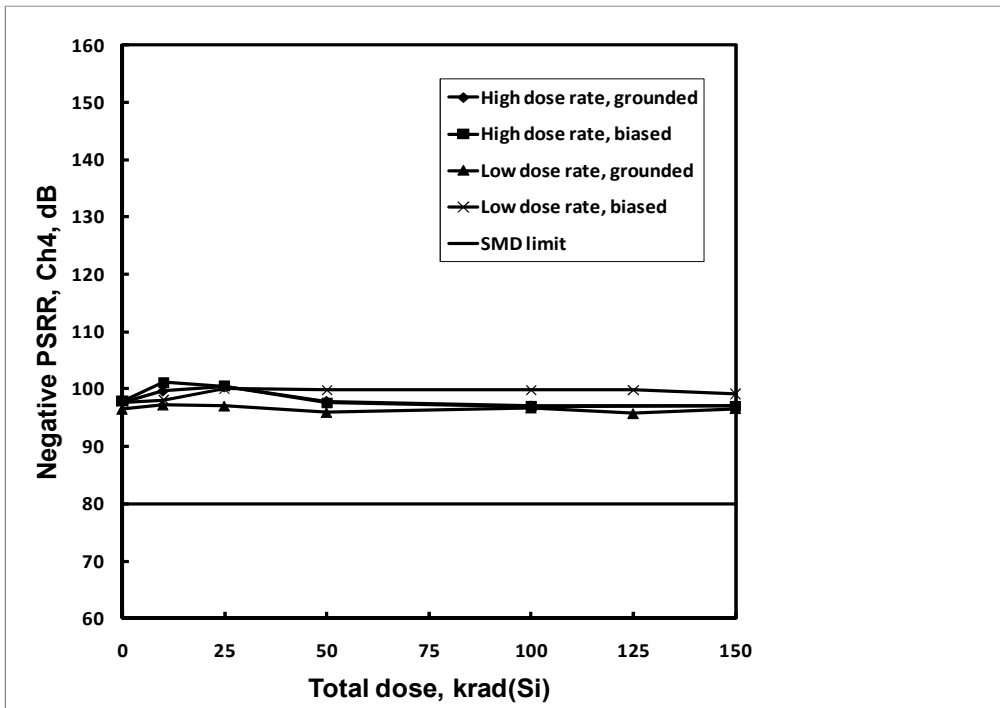

Fig. 67: HS-OP470ARH negative power supply rejection ratio, channel 4, as a function of total dose irradiation at low and high dose rate for the unbiased and biased cases. The post-irradiation SMD limit is 80dB minimum.

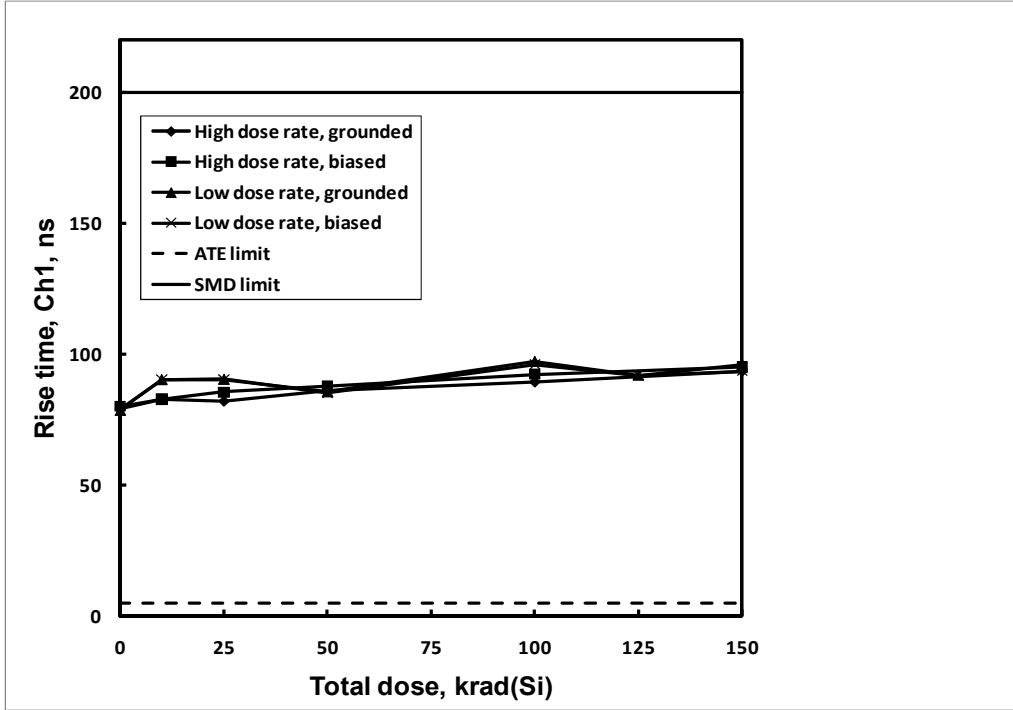

Fig. 68: HS-OP470ARH rise time, channel 1, as a function of total dose irradiation at low and high dose rate for the unbiased and biased cases. The post-irradiation SMD limit is 200ns maximum. The 5ns bound is an ATE limit.

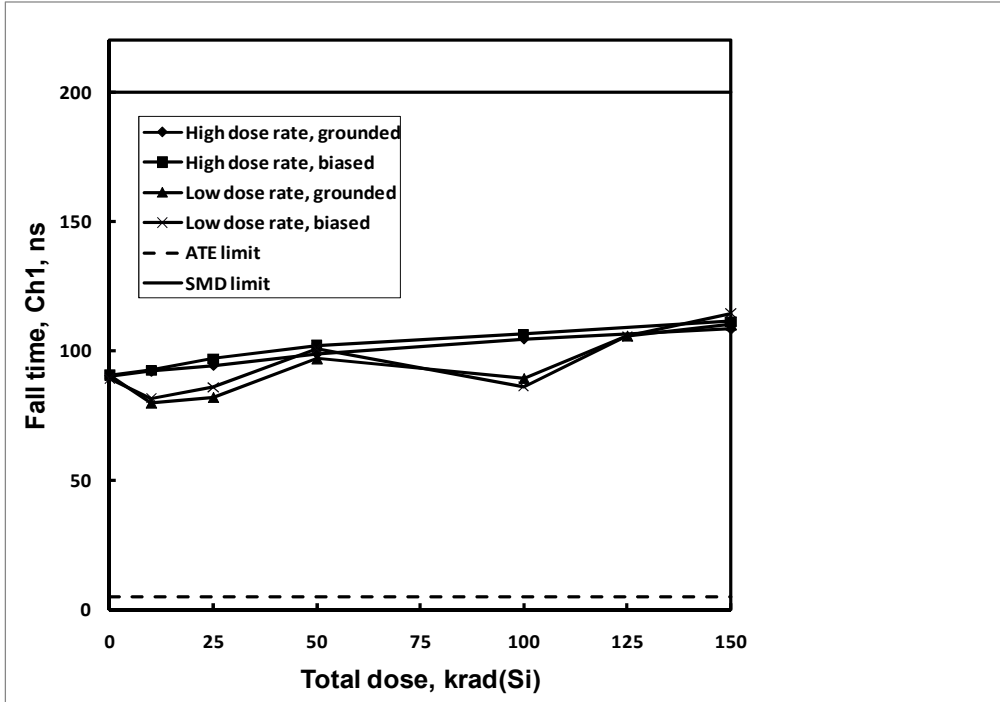

Fig. 69: HS-OP470ARH fall time, channel 1, as a function of total dose irradiation at low and high dose rate for the unbiased and biased cases. The post-irradiation SMD limit is 200ns maximum. The 5ns bound is an ATE limit.

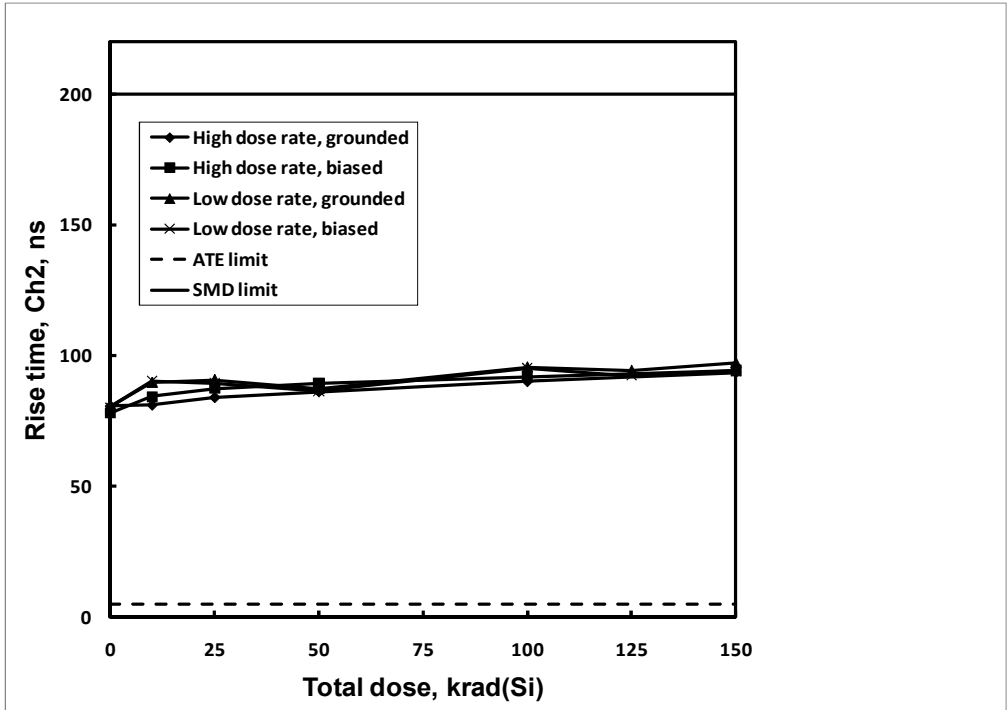

Fig. 70: HS-OP470ARH rise time, channel 2, as a function of total dose irradiation at low and high dose rate for the unbiased and biased cases. The post-irradiation SMD limit is 200ns maximum. The 5ns bound is an ATE limit.

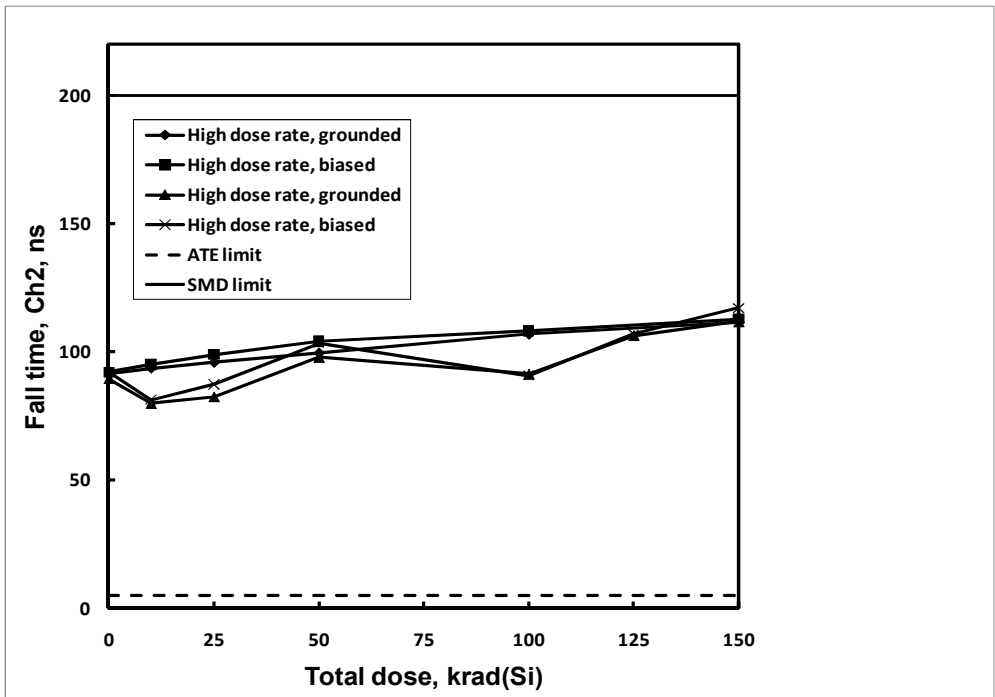

Fig. 71: HS-OP470ARH fall time, channel 2, as a function of total dose irradiation at low and high dose rate for the unbiased and biased cases. The post-irradiation SMD limit is 200ns maximum. The 5ns bound is an ATE limit.

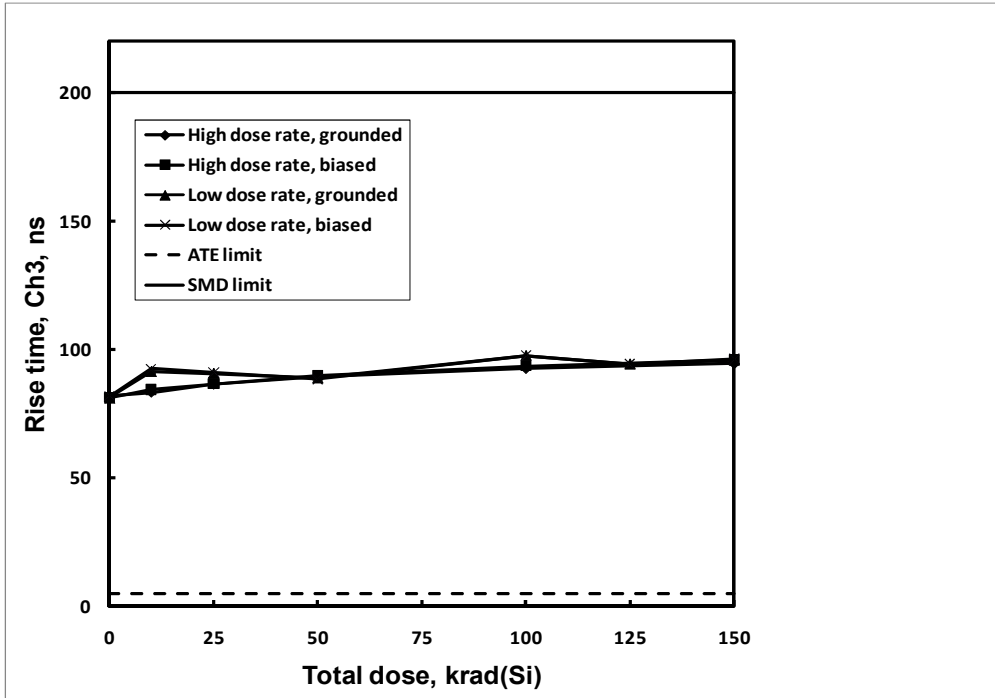

Fig. 72: HS-OP470ARH rise time, channel 3, as a function of total dose irradiation at low and high dose rate for the unbiased and biased cases. The post-irradiation SMD limit is 200ns maximum. The 5ns bound is an ATE limit.

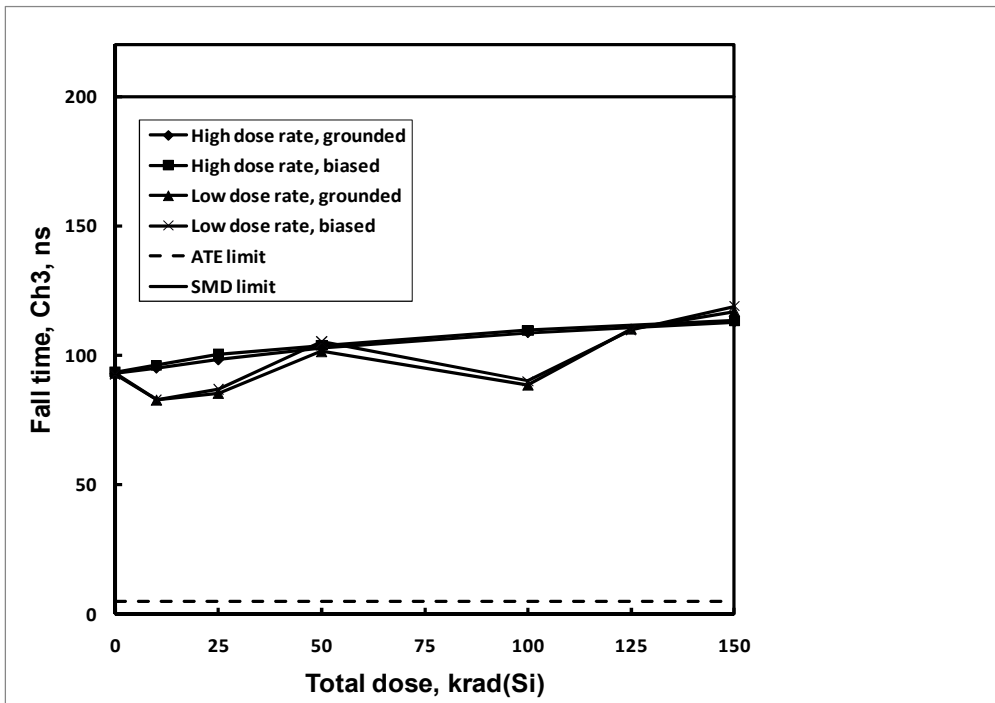
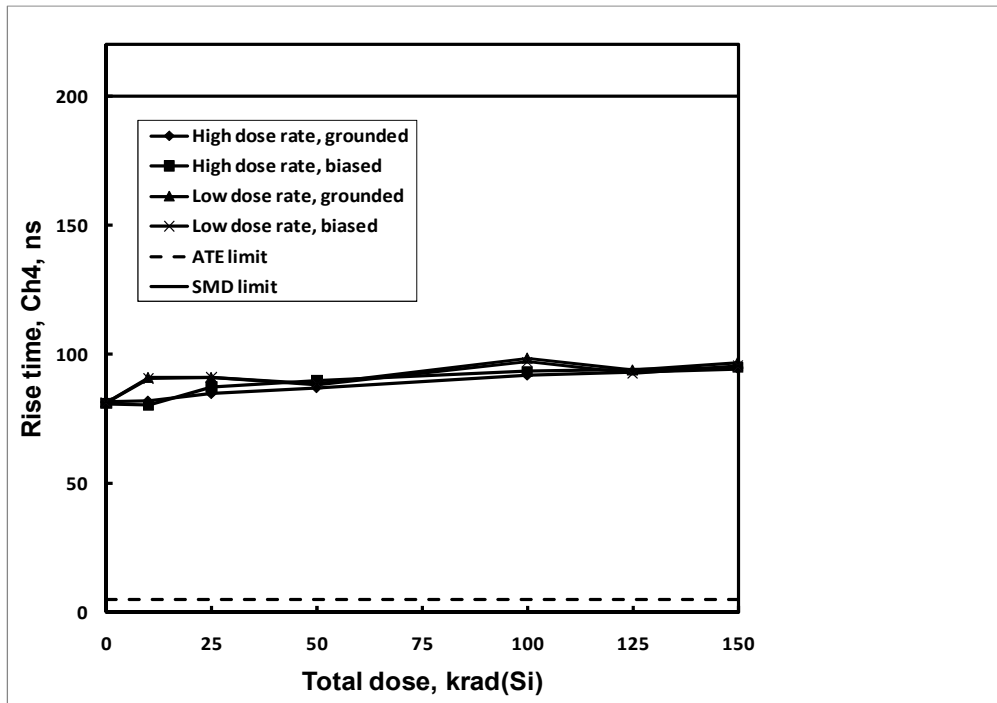
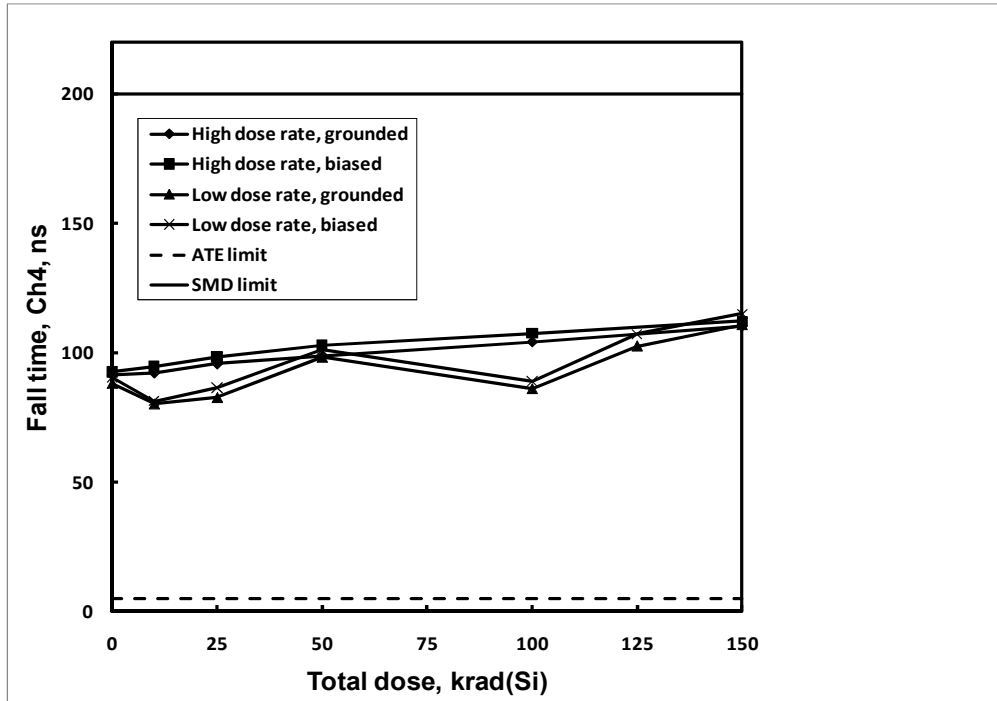

Fig. 73: HS-OP470ARH fall time, channel 3, as a function of total dose irradiation at low and high dose rate for the unbiased and biased cases. The post-irradiation SMD limit is 200ns maximum. The 5ns bound is an ATE limit.





**Fig. 74:** HS-OP470ARH rise time, channel 4, as a function of total dose irradiation at low and high dose rate for the unbiased and biased cases. The post-irradiation SMD limit is 200ns maximum. The 5ns bound is an ATE limit.



**Fig. 75:** HS-OP470ARH fall time, channel 4, as a function of total dose irradiation at low and high dose rate for the unbiased and biased cases. The post-irradiation SMD limit is 200ns maximum. The 5ns bound is an ATE limit.

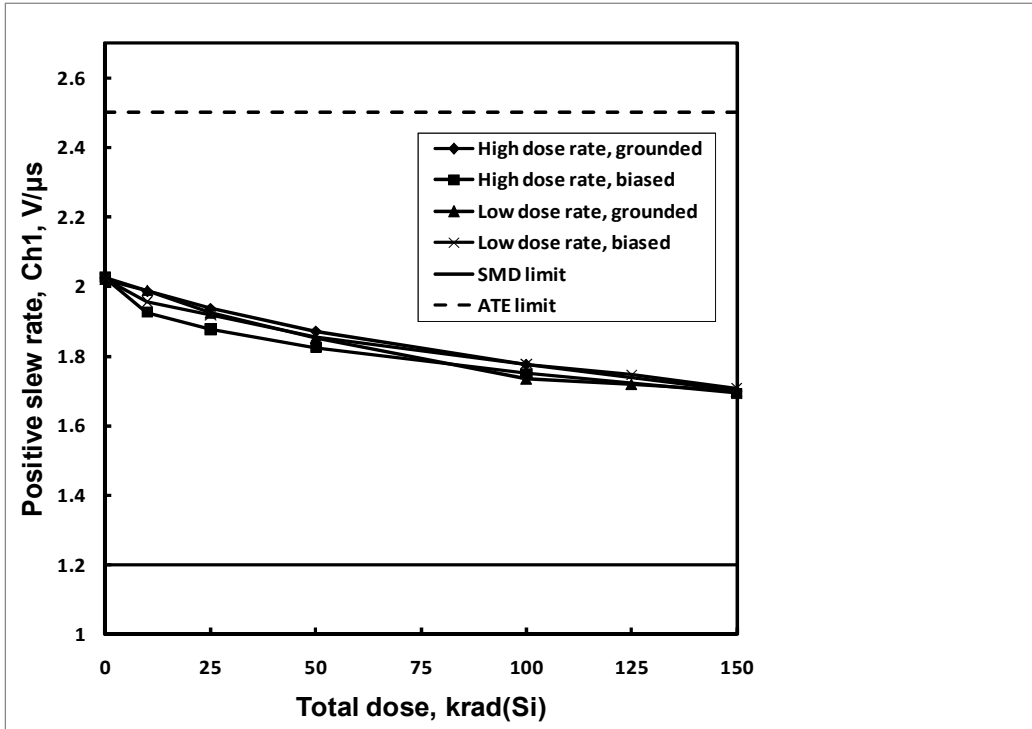

Fig. 76: HS-OP470ARH positive slew rate, channel 1, as a function of total dose irradiation at low and high dose rate for the unbiased and biased cases. The post-irradiation SMD limit is 1.2V/μs minimum. The 2.5V/μs bound is an ATE limit.

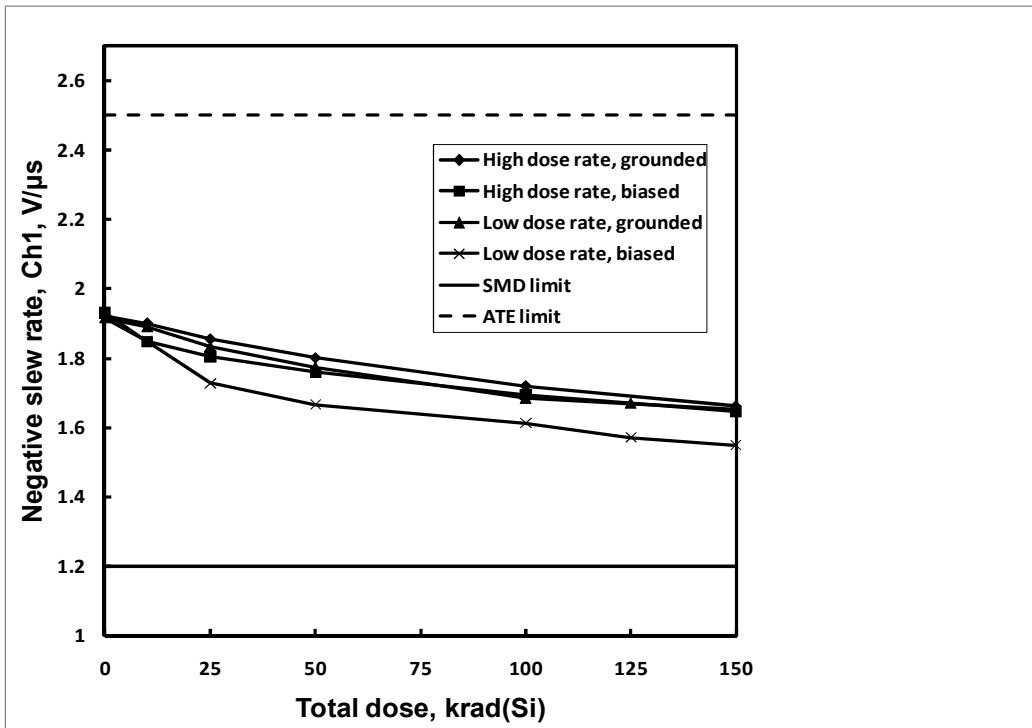

Fig. 77: HS-OP470ARH negative slew rate, channel 1, as a function of total dose irradiation at low and high dose rate for the unbiased and biased cases. The post-irradiation SMD limit is 1.2V/μs minimum. The 2.5V/μs bound is an ATE limit.

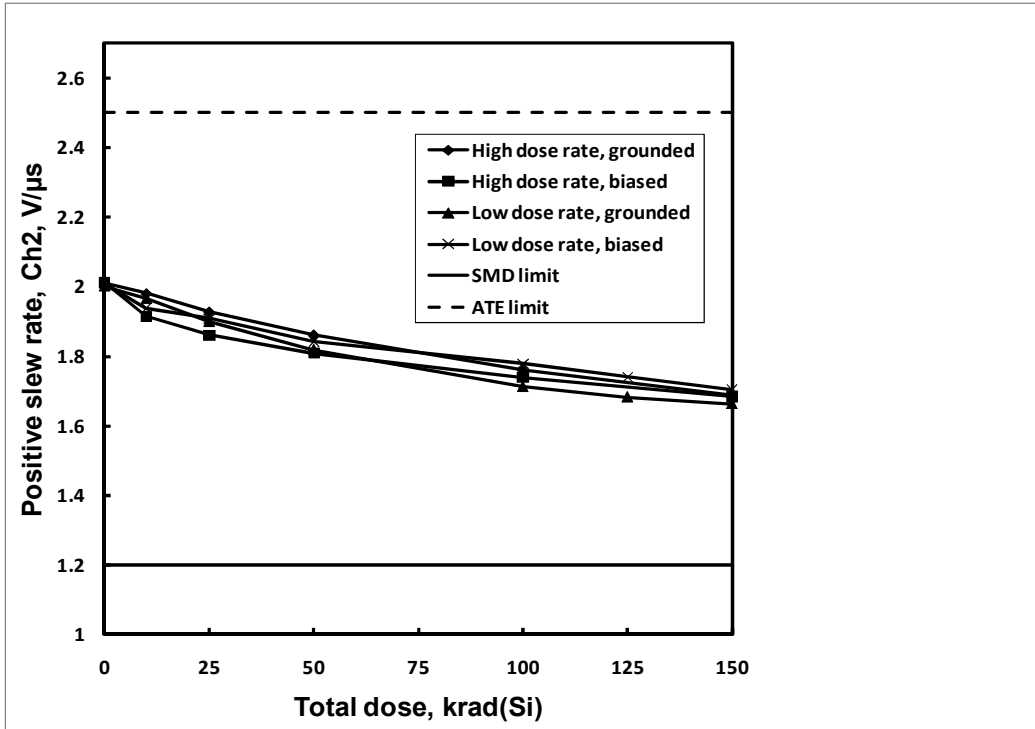

Fig. 78: HS-OP470ARH positive slew rate, channel 2, as a function of total dose irradiation at low and high dose rate for the unbiased and biased cases. The post-irradiation SMD limit is 1.2V/μs minimum. The 2.5V/μs bound is an ATE limit.

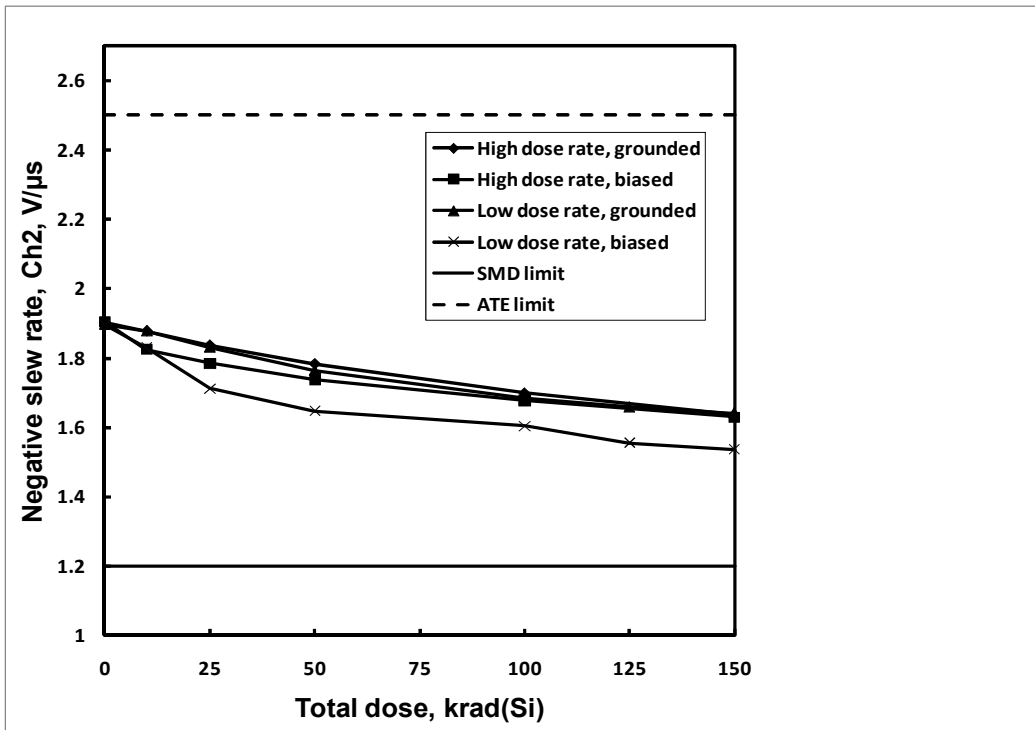

Fig. 79: HS-OP470ARH negative slew rate, channel 2, as a function of total dose irradiation at low and high dose rate for the unbiased and biased cases. The post-irradiation SMD limit is 1.2V/μs minimum. The 2.5V/μs bound is an ATE limit.

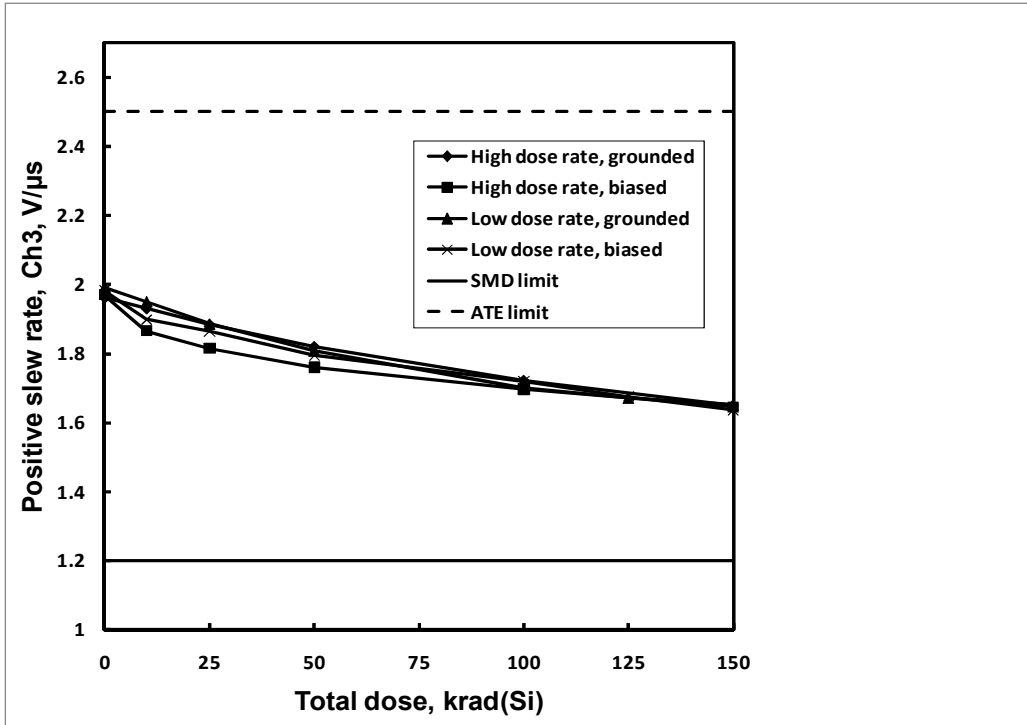

Fig. 80: HS-OP470ARH positive slew rate, channel 3, as a function of total dose irradiation at low and high dose rate for the unbiased and biased cases. The post-irradiation SMD limit is 1.2V/μs minimum. The 2.5V/μs bound is an ATE limit.

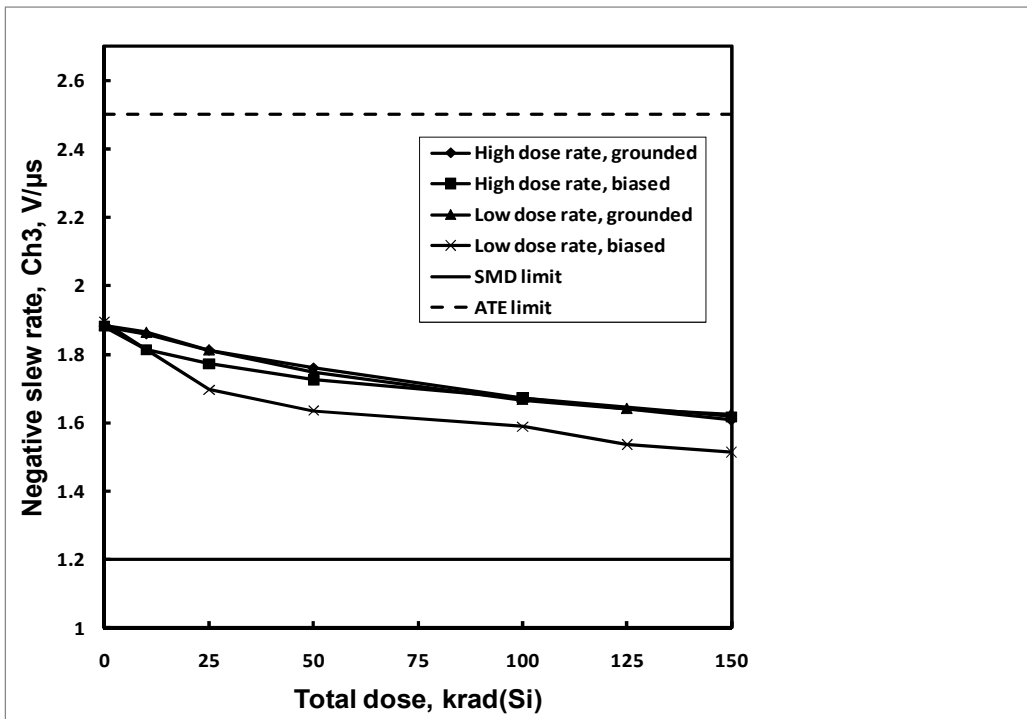

Fig. 81: HS-OP470ARH negative slew rate, channel 3, as a function of total dose irradiation at low and high dose rate for the unbiased and biased cases. The post-irradiation SMD limit is 1.2V/μs minimum. The 2.5V/μs bound is an ATE limit.

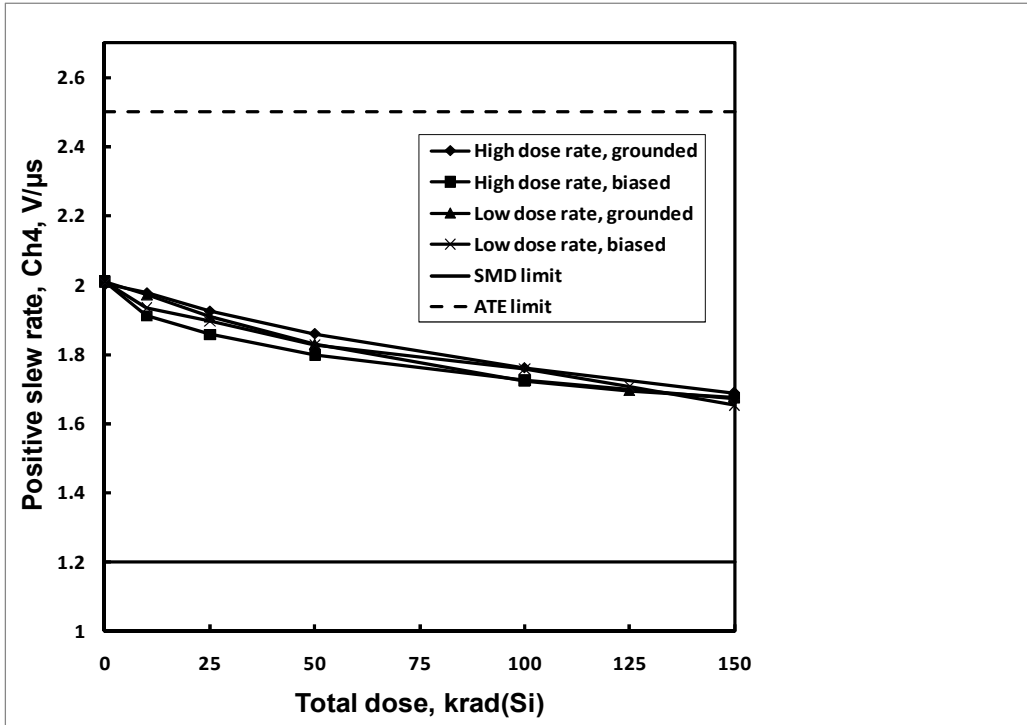

Fig. 82: HS-OP470ARH positive slew rate, channel 4, as a function of total dose irradiation at low and high dose rate for the unbiased and biased cases. The post-irradiation SMD limit is 1.2V/μs minimum. The 2.5V/μs bound is an ATE limit.

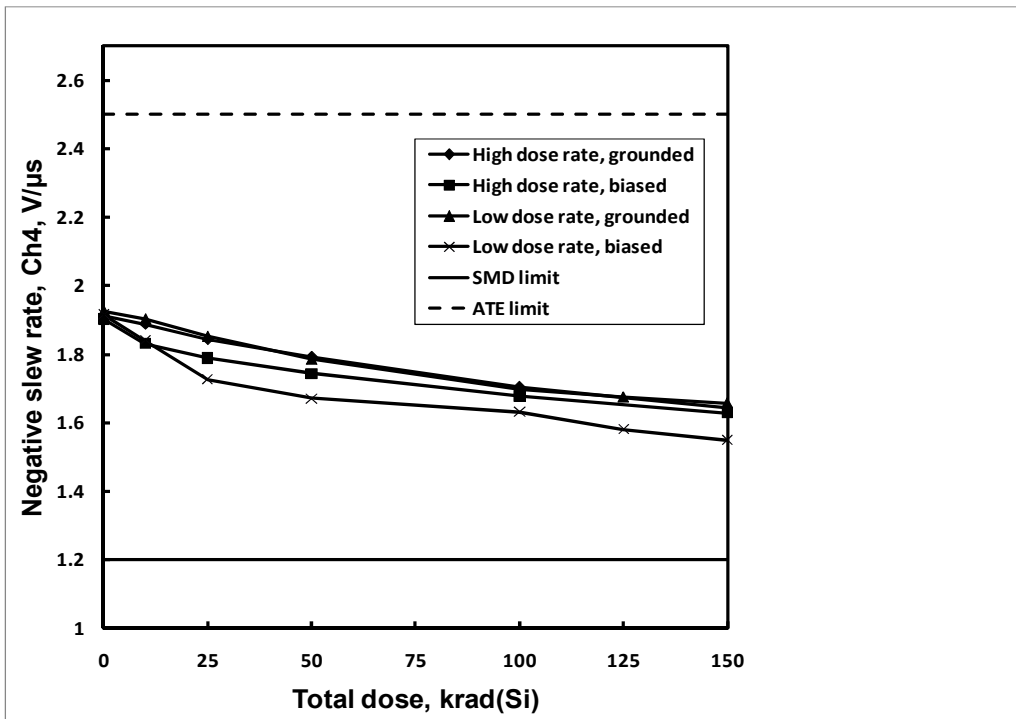

Fig. 83: HS-OP470ARH negative slew rate, channel 4, as a function of total dose irradiation at low and high dose rate for the unbiased and biased cases. The post-irradiation SMD limit is 1.2V/μs minimum. The 2.5V/μs bound is an ATE limit.

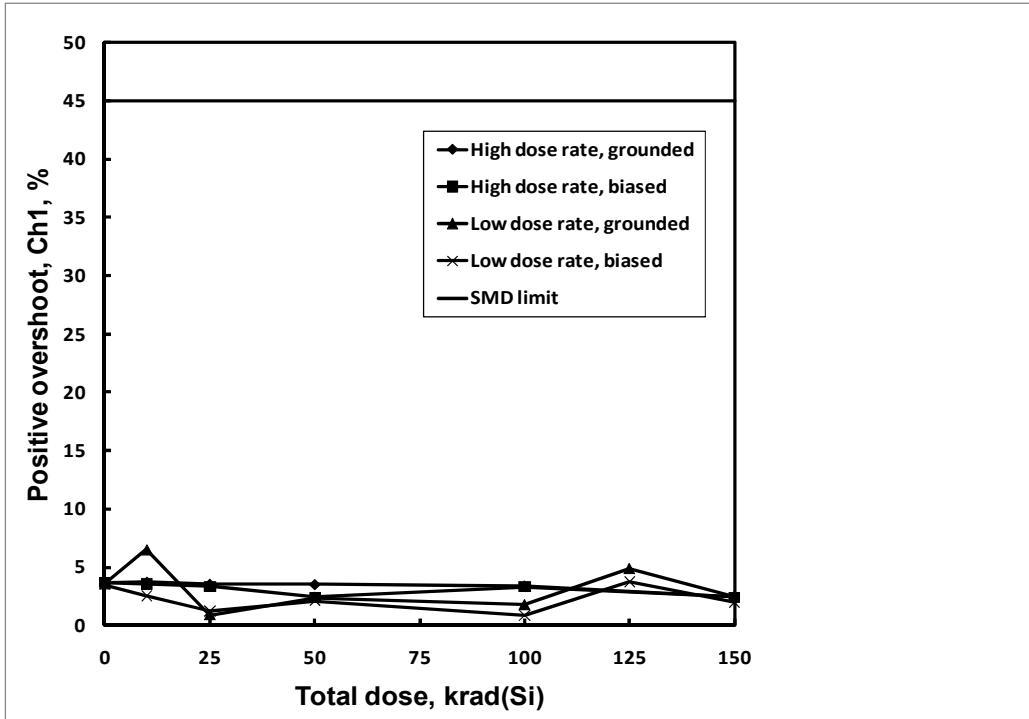

Fig. 84: HS-OP470ARH positive overshoot, channel 1, as a function of total dose irradiation at low and high dose rate for the unbiased and biased cases. The post-irradiation SMD limit is 45% maximum.

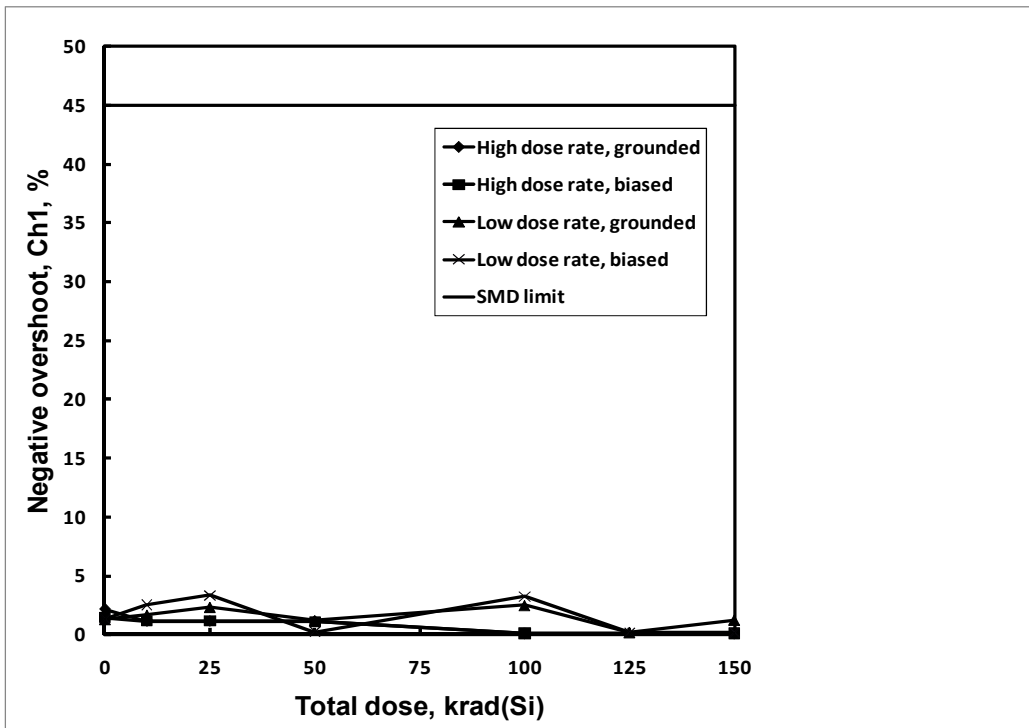

Fig. 85: HS-OP470ARH negative overshoot, channel 1, as a function of total dose irradiation at low and high dose rate for the unbiased and biased cases. The post-irradiation SMD limit is 45% maximum.

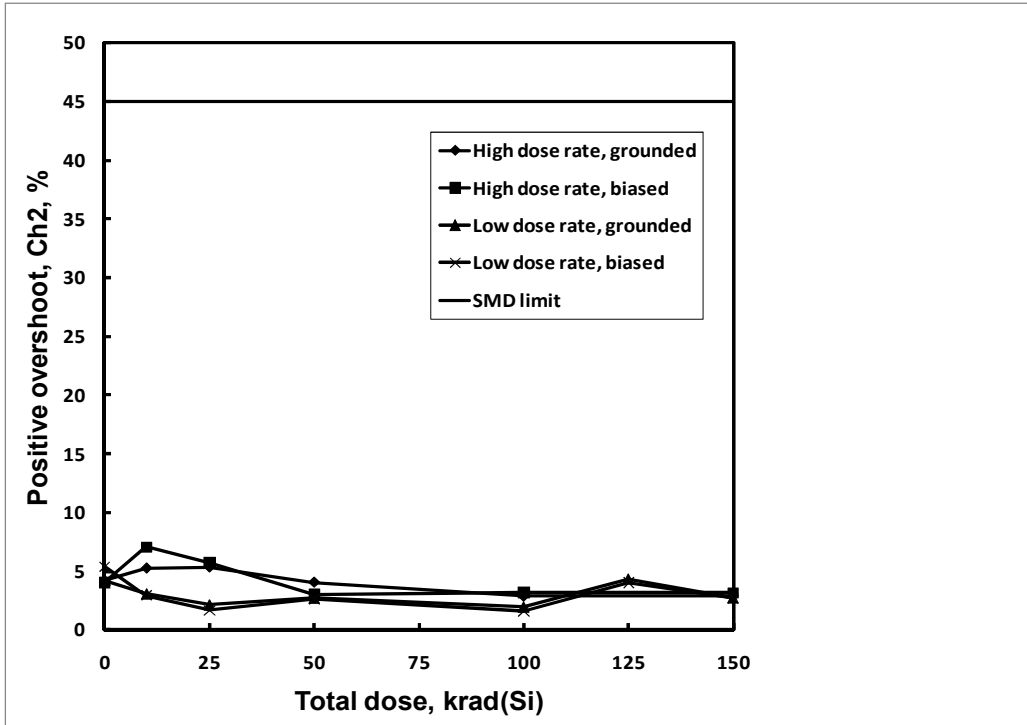

Fig. 86: HS-OP470ARH positive overshoot, channel 2, as a function of total dose irradiation at low and high dose rate for the unbiased and biased cases. The post-irradiation SMD limit is 45% maximum.

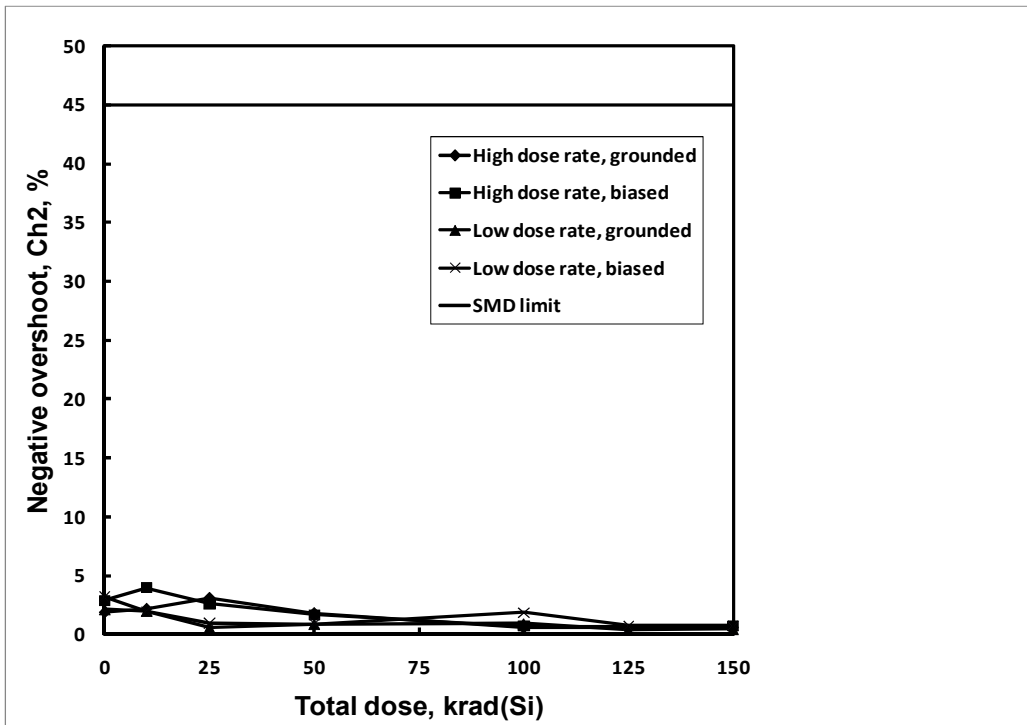

Fig. 87: HS-OP470ARH negative overshoot, channel 2, as a function of total dose irradiation at low and high dose rate for the unbiased and biased cases. The post-irradiation SMD limit is 45% maximum.

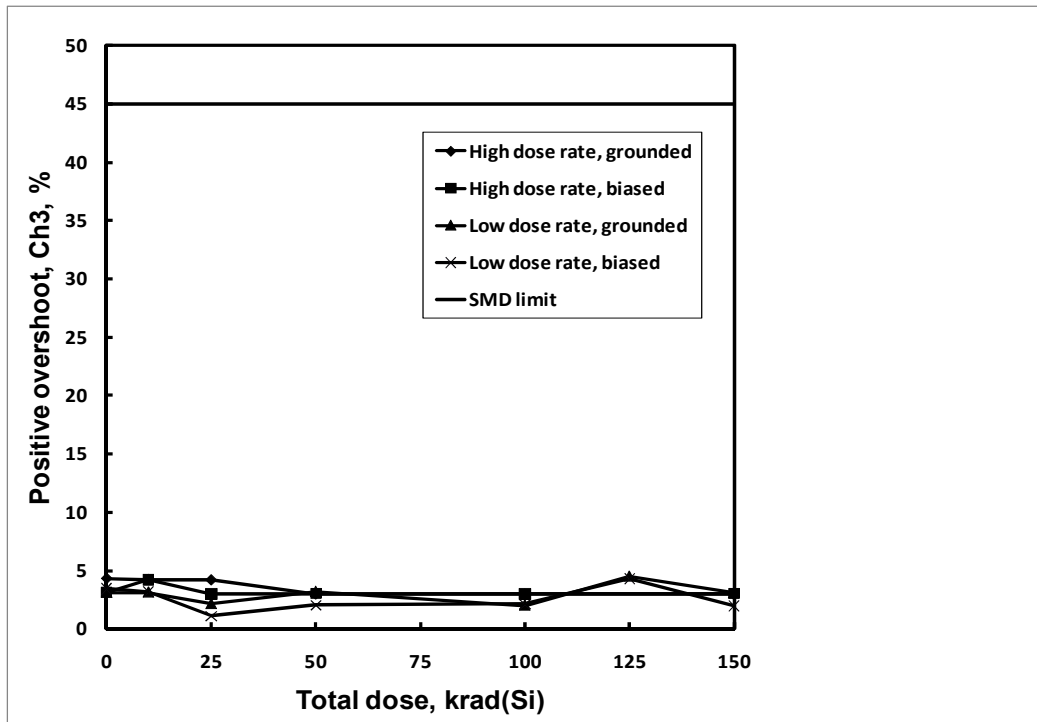

Fig. 88: HS-OP470ARH positive overshoot, channel 3, as a function of total dose irradiation at low and high dose rate for the unbiased and biased cases. The post-irradiation SMD limit is 45% maximum.

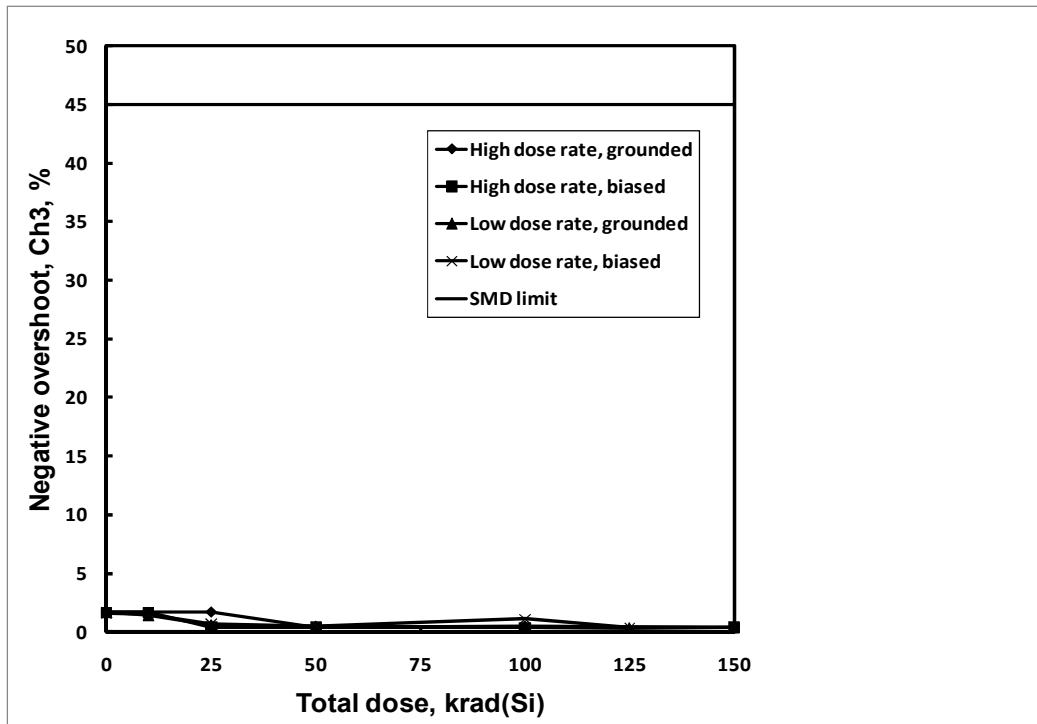

Fig. 89: HS-OP470ARH negative overshoot, channel 3, as a function of total dose irradiation at low and high dose rate for the unbiased and biased cases. The post-irradiation SMD limit is 45% maximum.



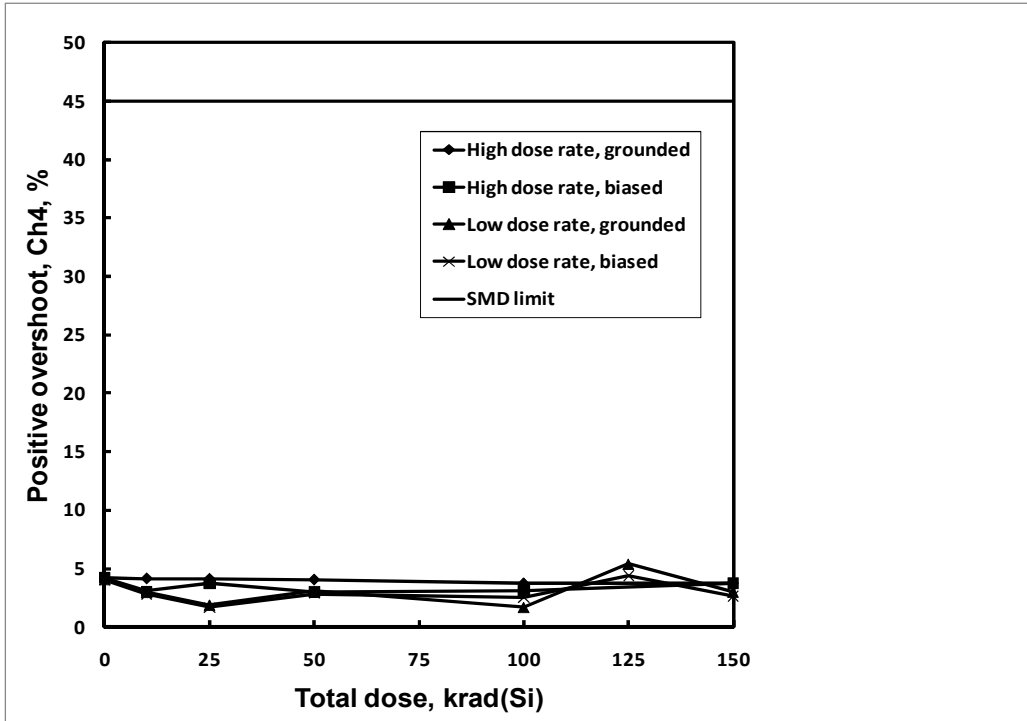

Fig. 90: HS-OP470ARH positive overshoot, channel 4, as a function of total dose irradiation at low and high dose rate for the unbiased and biased cases. The post-irradiation SMD limit is 45% maximum.

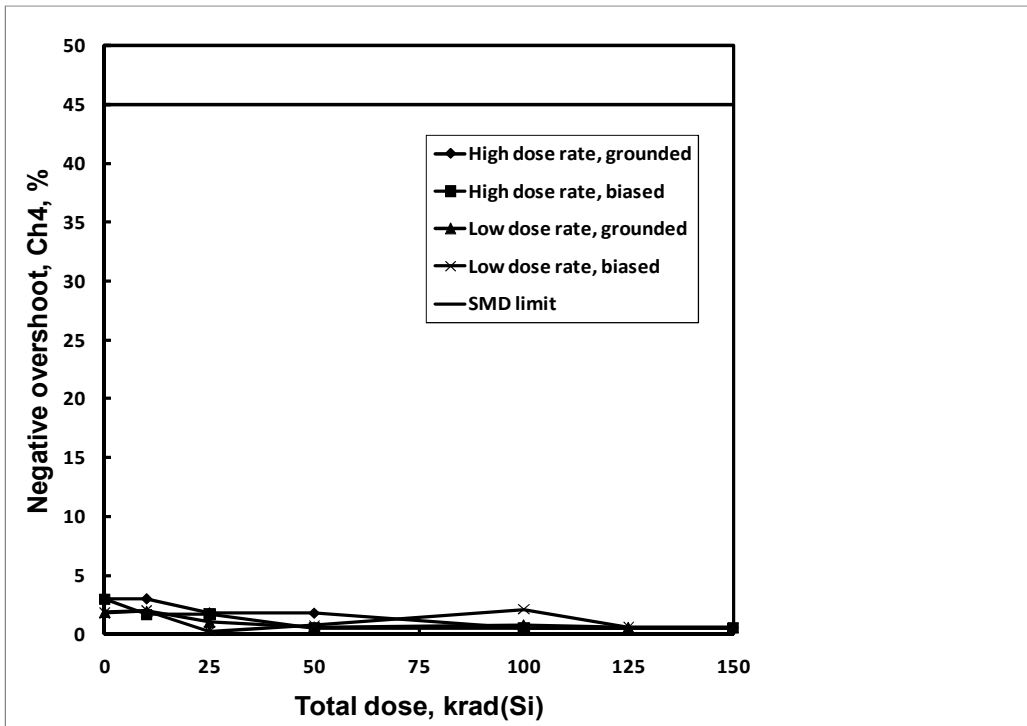

Fig. 91: HS-OP470ARH negative overshoot, channel 4, as a function of total dose irradiation at low and high dose rate for the unbiased and biased cases. The post-irradiation SMD limit is 45% maximum.

## 6: Conclusion

This document reports results of a total dose test of the HS-OP470ARH quad operational amplifier. Parts were tested at low and high dose rate under biased and unbiased conditions as outlined in MIL-STD-883 Test Method 1019.7, to a maximum total dose of 150krad(Si).

The input offset voltage was stable and was well within the +/-2.6mV SMD post-irradiation specification at the 150krad(Si) downpoint. The positive input bias current was outside the +/-630nA post-irradiation limit for the biased low dose rate samples at the 25krad(Si) downpoint and was then stable out to the 150krad(Si) level. The positive input bias current was stable out to 150krad(Si) for the grounded low dose rate samples and for the grounded and biased high dose rate samples. We believe the biased low dose rate samples were overstressed during irradiation before the 25krad(Si) level and thus consider the data for these samples to be artifactual. The input offset current represents the difference between the two input bias current values and was hence out of specification for the biased low dose rate samples as well.

Open-loop gain and output current showed some degradation but was within the SMD post-irradiation limits after 150krad(Si). Common mode rejection ratio, power supply rejection ratio, output voltage swing and power supply current were all stable. Rise and fall time and overshoot were stable, while slew rate showed some decrease but was well within the SMD limits at the 150krad(Si) level.

The part is implemented in the Intersil EBHF process. This work is the first Intersil low dose rate vs. high dose rate test of this process. The HS-OP470ARH data showed little, if any, low dose rate or bias sensitivity, with the low dose rate biased condition marginally worst-case for some parameters. The EBHF process uses a multilayer nitride over Silox passivation structure consisting of 12000Å of silicon dioxide ('Silox') and 3500Å of silicon nitride, with the nitride the upper layer and the Silox in contact with the chip. Passivation structure, composition and deposition process have been shown to strongly affect the low and high dose rate response of the resulting parts. This result is in disagreement with data for Intersil RSG parts, which uses single-layer Silox passivation. In these parts the grounded low dose rate condition was generally found to be worst case.

## 7: Appendices

### 7.1: Reported parameters, SMD limits and figure numbers.

Fig.	Parameter	Limit, low	Limit, high	Units	Notes
2	Input offset voltage	-2.6	+2.6	mV	Channel 1
3	Input offset voltage	-2.6	+2.6	mV	Channel 2
4	Input offset voltage	-2.6	+2.6	mV	Channel 3
5	Input offset voltage	-2.6	+2.6	mV	Channel 4
6	Positive input bias current	-630	+630	nA	Channel 1
7	Negative input bias current	-630	+630	nA	Channel 1
8	Positive input bias current	-630	+630	nA	Channel 2
9	Negative input bias current	-630	+630	nA	Channel 2
10	Positive input bias current	-630	+630	nA	Channel 3
11	Negative input bias current	-630	+630	nA	Channel 3
12	Positive input bias current	-630	+630	nA	Channel 4
13	Negative input bias current	-630	+630	nA	Channel 4
14	Input offset current	-630	+630	nA	Channel 1
15	Input offset current	-630	+630	nA	Channel 2
16	Input offset current	-630	+630	nA	Channel 3
17	Input offset current	-630	+630	nA	Channel 4
18	Positive large signal voltage gain	40		kV/V	Channel 1
19	Negative large signal voltage gain	40		kV/V	Channel 1
20	Positive large signal voltage gain	40		kV/V	Channel 2
21	Negative large signal voltage gain	40		kV/V	Channel 2
22	Positive large signal voltage gain	40		kV/V	Channel 3
23	Negative large signal voltage gain	40		kV/V	Channel 3
24	Positive large signal voltage gain	40		kV/V	Channel 4
25	Negative large signal voltage gain	40		kV/V	Channel 4
26	Positive common mode rejection ratio	80		dB	Channel 1
27	Negative common mode rejection ratio	80		dB	Channel 1
28	Positive common mode rejection ratio	80		dB	Channel 2
29	Negative common mode rejection ratio	80		dB	Channel 2
30	Positive common mode rejection ratio	80		dB	Channel 3
31	Negative common mode rejection ratio	80		dB	Channel 3
32	Positive common mode rejection ratio	80		dB	Channel 4
33	Negative common mode rejection ratio	80		dB	Channel 4
34	Positive output voltage swing	+11		V	Channel 1, 2K load
35	Negative output voltage swing	-11		V	Channel 1, 2K load
36	Positive output voltage swing	+11		V	Channel 2, 2K load
37	Negative output voltage swing	-11		V	Channel 2, 2K load
38	Positive output voltage swing	+11		V	Channel 3, 2K load
39	Negative output voltage swing	-11		V	Channel 3, 2K load
40	Positive output voltage swing	+11		V	Channel 4, 2K load
41	Negative output voltage swing	-11		V	Channel 4, 2K load
42	Positive output voltage swing	+12		V	Channel 1, 10K load
43	Negative output voltage swing	-12		V	Channel 1, 10K load
44	Positive output voltage swing	+12		V	Channel 2, 10K load

45	Negative output voltage swing	-12		V	Channel 2, 10K load
46	Positive output voltage swing	+12		V	Channel 3, 10K load
47	Negative output voltage swing	-12		V	Channel 3, 10K load
48	Positive output voltage swing	+12		V	Channel 4, 10K load
49	Negative output voltage swing	-12		V	Channel 4, 10K load
50	Positive output current	+8		mA	Channel 1
51	Negative output current	-8		mA	Channel 1
52	Positive output current	+8		mA	Channel 2
53	Negative output current	-8		mA	Channel 2
54	Positive output current	+8		mA	Channel 3
55	Negative output current	-8		mA	Channel 3
56	Positive output current	+8		mA	Channel 4
57	Negative output current	-8		mA	Channel 4
58	Positive power supply current		+5.5	mA	
59	Negative power supply current		-5.5	mA	
60	Positive power supply rejection ratio	80		dB	Channel 1
61	Negative power supply rejection ratio	80		dB	Channel 1
62	Positive power supply rejection ratio	80		dB	Channel 2
63	Negative power supply rejection ratio	80		dB	Channel 2
64	Positive power supply rejection ratio	80		dB	Channel 3
65	Negative power supply rejection ratio	80		dB	Channel 3
66	Positive power supply rejection ratio	80		dB	Channel 4
67	Negative power supply rejection ratio	80		dB	Channel 4
68	Rise time	200		ns	Channel 1
69	Fall time	200		ns	Channel 1
70	Rise time	200		ns	Channel 2
71	Fall time	200		ns	Channel 2
72	Rise time	200		ns	Channel 3
73	Fall time	200		ns	Channel 3
74	Rise time	200		ns	Channel 4
75	Fall time	200		ns	Channel 4
76	Positive slew rate	1.2		V/ $\mu$ s	Channel 1
77	Negative slew rate	1.2		V/ $\mu$ s	Channel 1
78	Positive slew rate	1.2		V/ $\mu$ s	Channel 2
79	Negative slew rate	1.2		V/ $\mu$ s	Channel 2
80	Positive slew rate	1.2		V/ $\mu$ s	Channel 3
81	Negative slew rate	1.2		V/ $\mu$ s	Channel 3
82	Positive slew rate	1.2		V/ $\mu$ s	Channel 4
83	Negative slew rate	1.2		V/ $\mu$ s	Channel 4
84	Positive overshoot	45		%	Channel 1
85	Negative overshoot	45		%	Channel 1
86	Positive overshoot	45		%	Channel 2
87	Negative overshoot	45		%	Channel 2
88	Positive overshoot	45		%	Channel 3
89	Negative overshoot	45		%	Channel 3
90	Positive overshoot	45		%	Channel 4
91	Negative overshoot	45		%	Channel 4

Note 1: Limits are taken from Standard Microcircuit Drawing (SMD) 5962-98533.

### 8: Document revision history

Revision	Date	Pages	Comments
0	1 December 2010	All	Original issue