



Total dose testing of the HS-139RH quad voltage comparator

Nick van Vonno
Intersil Corporation

Revision 1
June 2010

Table of Contents

- 1. Introduction**
- 2. Reference Documents**
- 3. Part Description**
- 4. Test Description**
 - 4.1 Irradiation facility**
 - 4.2 Test fixturing**
 - 4.3 Characterization equipment and procedures**
 - 4.4 Experimental Matrix**
 - 4.5 Downpoints**
- 5 Results**
 - 5.1 Test results**
 - 5.2 Variables data**
- 6 Discussion**
- 7 Conclusion**
- 8 Appendices**
- 9 Document revision history**

1. Introduction

This report summarizes the results of a low and high dose rate total dose test of the HS-139RH quad voltage comparator. The test was conducted in order to determine the sensitivity of the part to the total dose environment and to low dose rate irradiation in particular.

2. Reference Documents

- MIL-STD-883G test method 1019.7
- MIL-PRF-38535 (QML)
- HS-139RH data sheet, Intersil document
- DSCC Standard Microcircuit Drawing (SMD) 5962-98613

3: Part Description

The radiation hardened HS-139RH consists of four independent single or dual supply voltage comparators on a single monolithic substrate. The common mode input voltage range includes ground, even when operated from a single supply, and the low supply current makes these comparators suitable for low power applications. The HS-139RH is designed to directly interface with TTL and CMOS logic circuitry.

The HS-139RH is fabricated on Intersil's dielectrically isolated Rad Hard Silicon Gate (RSG) process, which provides immunity to latch-up from any cause and the capability of highly reliable performance in the total dose and single-event effects (SEE) radiation environments.

The HS-139RH is produced in conformance with MIL-PRF-38535 (QML). Specifications for radiation hardness assured (RHA) QML devices are controlled by the Defense Supply Center (DSCC) in Columbus, OH. The SMD numbers listed in the ordering information must be used when ordering. Detailed electrical specifications for the HS-139RH are contained in SMD 5962-98613.

- Electrically screened to DSCC SMD # 5962-98613
- QML qualified per MIL-PRF-38535 requirements
- Radiation Environment:
 - Latch-up free under any conditions
 - Total dose (maximum) 3×10^5 rad(Si) (50 – 300 rad(Si)/s)
- 100V output voltage withstand capability
- ESD protection to >3000V
- Differential input voltage range equal to the supply voltage
- Input offset voltage (V_{IO}) 2mV (maximum)
- Quiescent supply current 2mA (maximum)
- Pb-free (RoHS compliant)

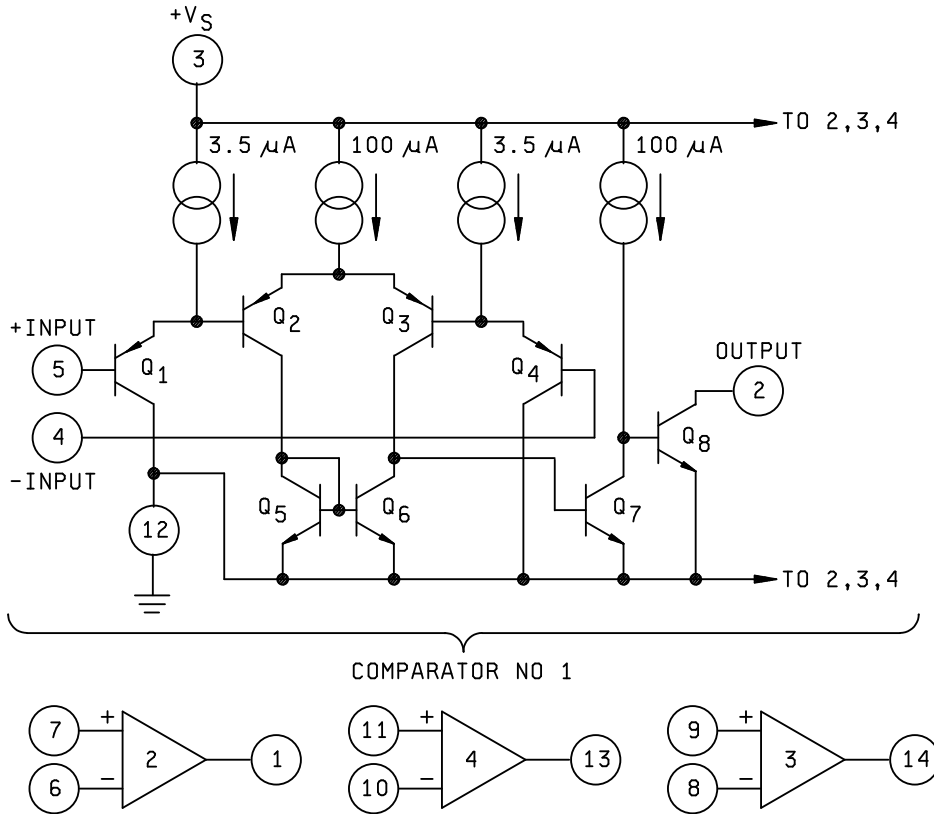

Figure 1: HS-139RH block diagram.

4: Test Description

4.1 Irradiation Facilities

High dose rate testing was performed using a Gammacell 220 ⁶⁰Co irradiator located in the Palm Bay, Florida Intersil facility. Low dose rate testing was performed on a subcontract basis at White Sands Missile Range (White Sands, NM). The use of an off-site irradiator necessitated detailed precautions to control the packing temperature during shipment to avoid annealing effects. This was accomplished by the use of Styrofoam shipping containers, Gelpack cold packs and miniaturized strip chart recorders to provide a continuous temperature monitor.

The high dose rate irradiations were done at 55rad(Si)/s and the low dose rate work was performed at .010rad(Si)/s, both per MIL-STD-883 Method 1019.7. Dosimetry for both tests was performed using Far West Technology radiochromic dosimeters and on-site readout equipment.

4.2 Test Fixturing

Figure 2 shows the configuration used for biased irradiation in conformance with Standard Microcircuit Drawing (SMD) 5962-98613. This configuration was used for both low and high dose rate irradiation. The unbiased low dose rate irradiation was carried out with all pins grounded.

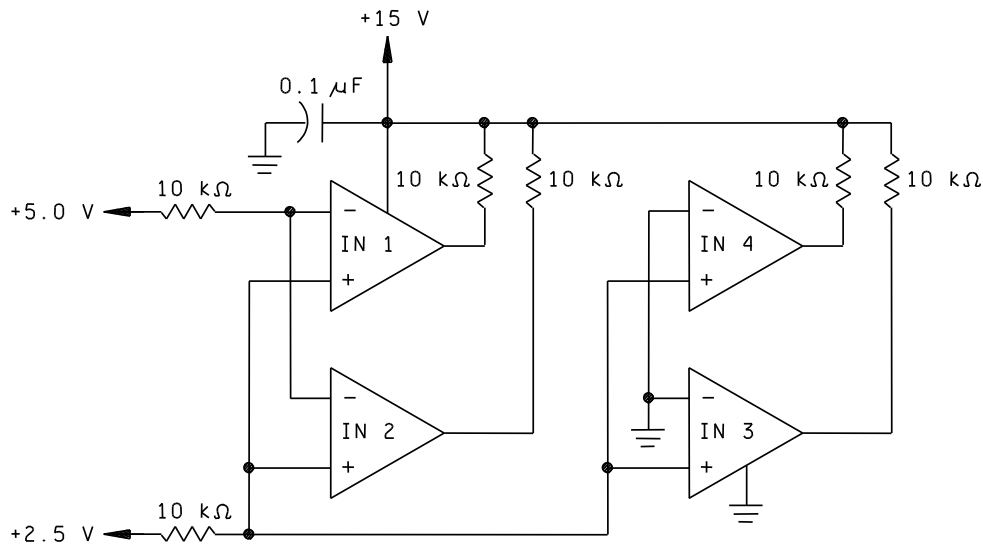

Figure 2: Irradiation bias configuration for the HS-139RH per Standard Microcircuit Drawing (SMD) 5962-98613, as used for both low and high dose rate biased irradiation.

4.3 Characterization equipment and procedures

All electrical testing was performed outside the irradiator using the production automated test equipment (ATE) with datalogging of all parameters at each downpoint. Downpoint electrical testing was performed at room temperature.

4.5 Experimental matrix

The experimental matrix consisted of four cells: five samples irradiated at high dose rate with all pins grounded, five samples irradiated at high dose rate under bias, five samples irradiated at low dose rate with all pins grounded and five samples irradiated at low dose rate under bias. One control unit was used. This experimental approach was in close compliance with the guidelines of MIL-STD-883 Test Method 1019.7 for diagnostic ELDRS testing.

Samples of the HS-139RH were drawn from production run PDCP2TFA, wafer 7, and were packaged in the standard hermetic 14-pin ceramic flatpack (CFP) production package. Samples were processed through the standard burnin cycle before irradiation, as required by MIL-STD-883, and were screened to the SMD 5962-98613 limits at room, low and high temperatures before the test.

4.6 Downpoints

Downpoints were zero, 50krad(Si), 100krad(Si) and 150krad(Si) for the high dose rate test and zero, 10krad(Si), 25krad(Si), 50krad(Si), 100krad(Si), 125krad(Si) and 150krad(Si) for the low dose rate test.

5: Results

5.1 Test results

The low and high dose rate tests of the HS-139RH are complete and showed no reject devices after irradiation to 150krad(Si) at low and high dose rate), screening to the SMD post-irradiation limits.

5.2 Variables data

The plots in Figures 3 through 23 show data at all downpoints. The plots show the median of 8 key parameters as a function of total dose for each of the four irradiation conditions. We chose to plot the median (as opposed to for example mean and standard deviation) because of the relatively small sample sizes involved. All parts showed good stability over irradiation, with no observed low dose rate sensitivity. Table 1, below, summarizes key parameters of the device that have been plotted in Figures 3 – 23. Terminology is in accordance with the applicable SMD 5962-98613. Refer to the Discussion section for further analysis.

Figures 12 through 15 explore possible channel sensitivity of the input bias current variation as a function of total dose. The figures plot the input bias current for all four channels as a function of dose for the 5V and 30V supply cases and for the biased and unbiased cases, all at low dose rate. We chose low dose rate for this analysis as the input bias parameter is the most sensitive to this condition. No systemic channel sensitivity was noted.

Table 1: Plotted parameters and limits.

Parameter	Symbol	Limits		Units
		minimum	maximum	
Total supply current	+Is		3	mA
Input offset voltage	Voff		8	mV
Input bias current	lib		1000	nA
Input offset current	lio		600	nA
Saturation voltage	Vsat1		400	mV
Saturation voltage	Vsat2		800	mV
Output sink current	losk	6		mA
Response time	tPLH		7	μs
Response time	tPHL		7	μs

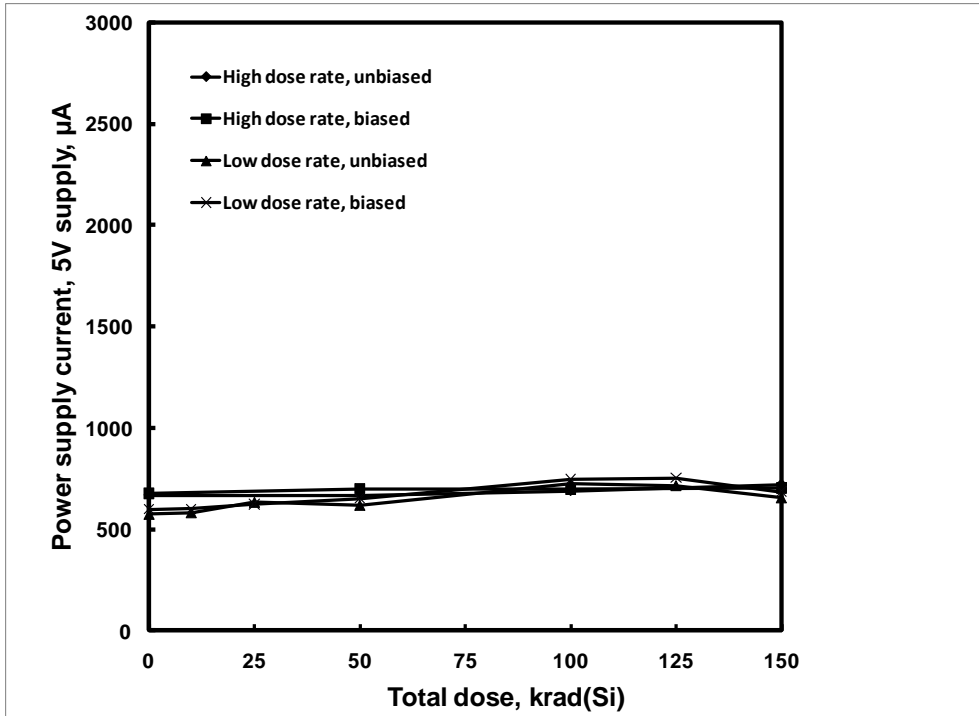

Figure 3: HS-139RH power supply current, 5V supply, as a function of total dose irradiation at low and high dose rate. The low dose rate was .01rad(Si)/s and the high dose rate was 55rad(Si)/s. Sample size for each cell was 5. The SMD limit for this parameter is 3mA maximum post-irradiation.

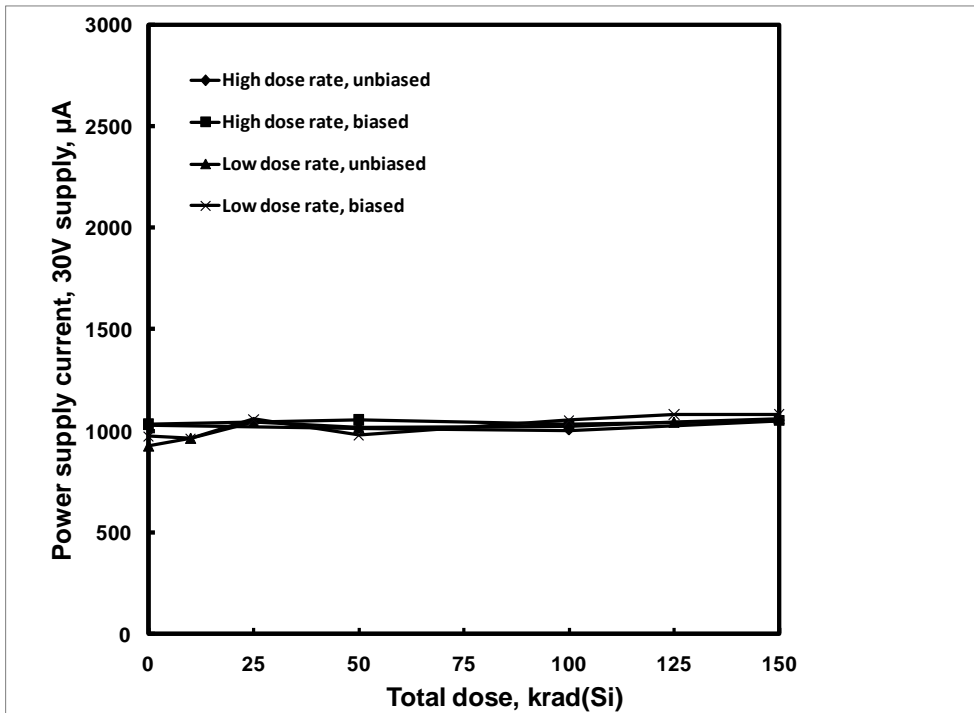

Figure 4: HS-139RH power supply current, 30V supply, as a function of total dose irradiation at low and high dose rate. The low dose rate was .01rad(Si)/s and the high dose rate was 55rad(Si)/s. Sample size for each cell was 5. The SMD limit for this parameter is 3mA maximum post-irradiation.

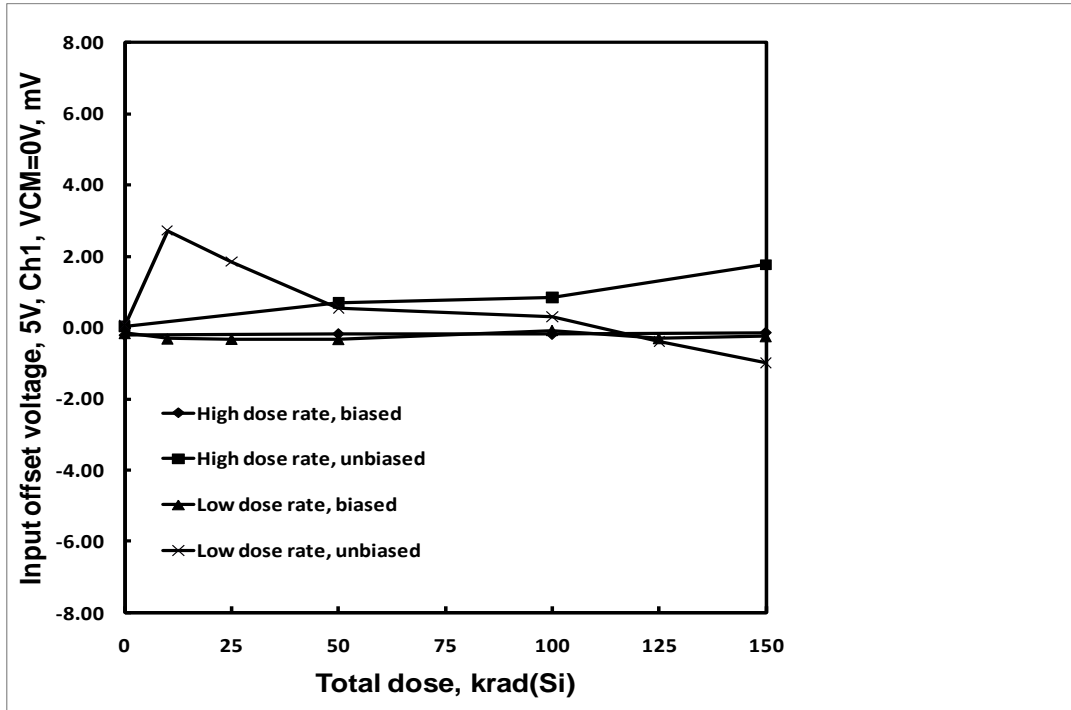

Figure 5: HS-139RH input offset voltage at 0V common mode voltage and 5V supply, channel 1, as a function of total dose irradiation at low and high dose rate. The low dose rate was .01rad(Si)/s and the high dose rate was 55rad(Si)/s. Sample size for each cell was 5. The SMD limit for this parameter is +/- 8mV post-irradiation.

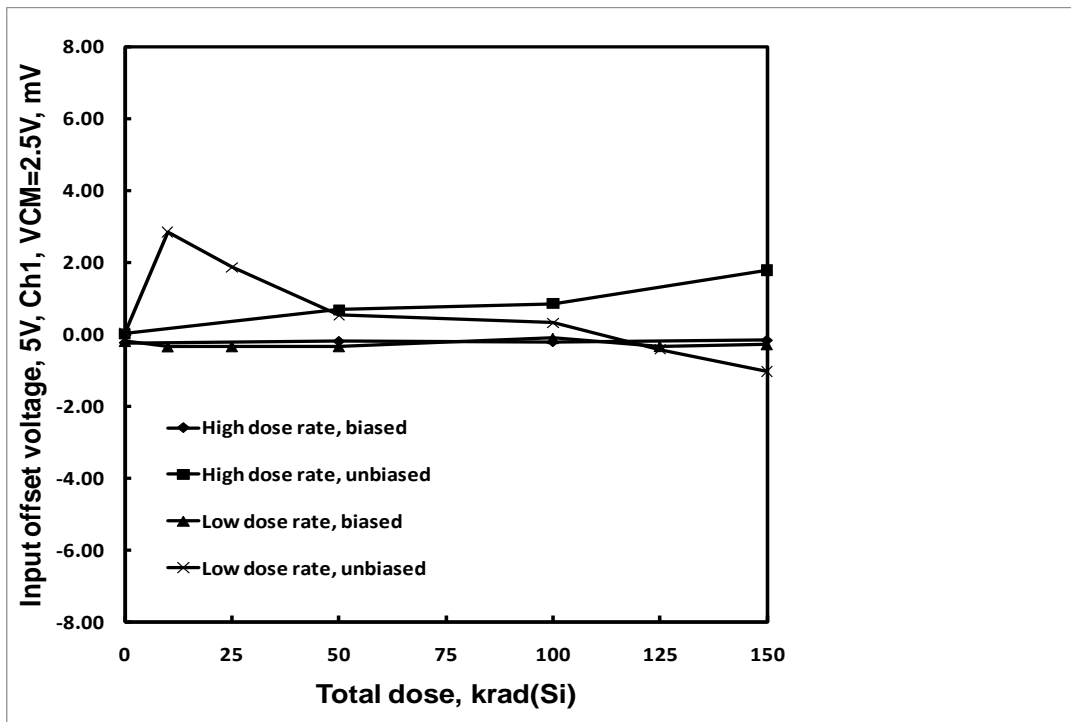

Figure 6: HS-139RH input offset voltage at 2.5V common mode voltage and 5V supply, channel 1, as a function of total dose irradiation at low and high dose rate. The low dose rate was .01rad(Si)/s and the high dose rate was 55rad(Si)/s. Sample size for each cell was 5. The SMD limit for this parameter is +/- 8mV post-irradiation.

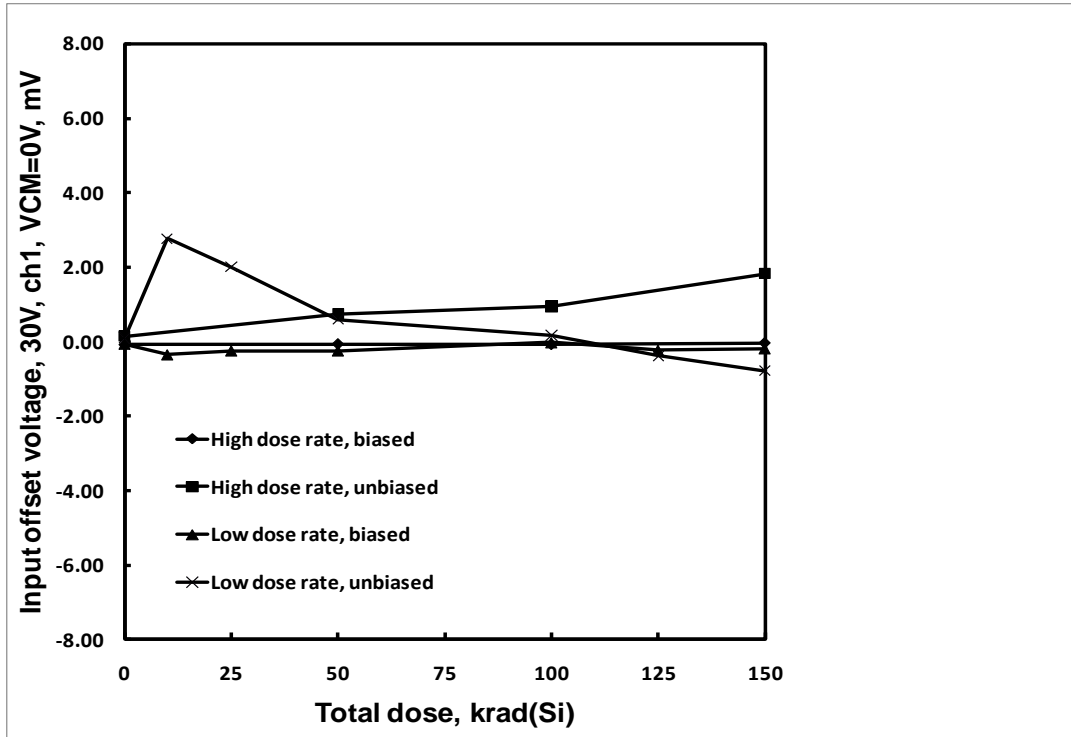

Figure 7: HS-139RH input offset voltage at 0V common mode voltage and 30V supply, channel 1, as a function of total dose irradiation at low and high dose rate. The low dose rate was .01rad(Si)/s and the high dose rate was 55rad(Si)/s. Sample size for each cell was 5. The SMD limit for this parameter is +/- 8mV post-irradiation.

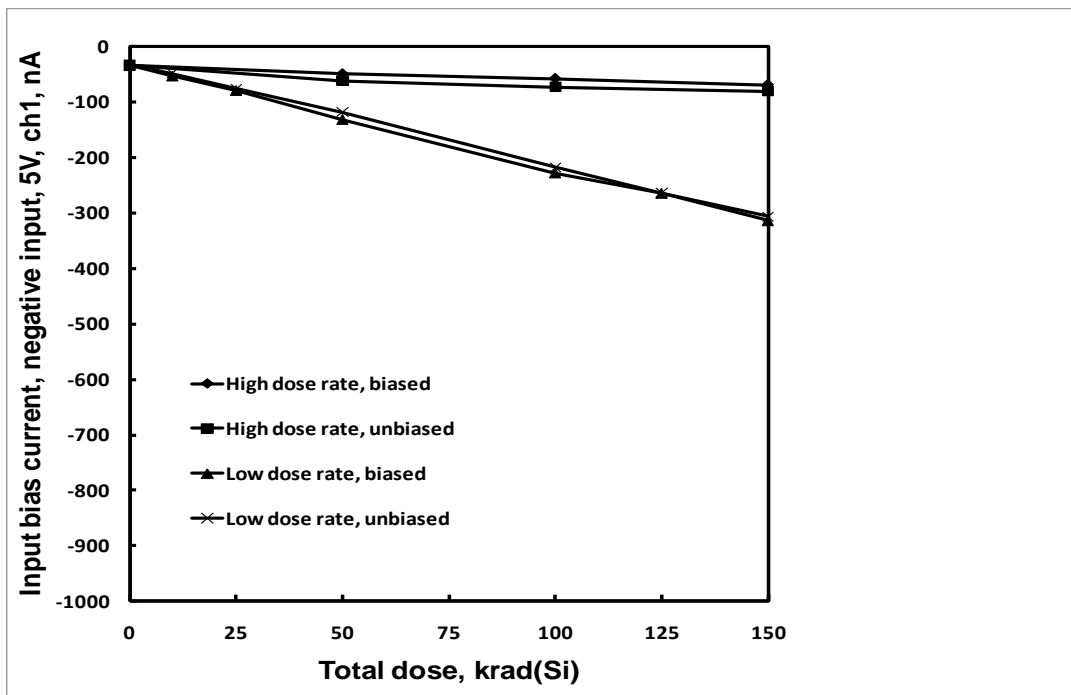

Figure 8: HS-139RH negative input bias current at 5V supply, channel 1, as a function of total dose irradiation at low and high dose rate. The low dose rate was .01rad(Si)/s and the high dose rate was 55rad(Si)/s. Sample size for each cell was 5. The SMD limit for this parameter is 1µA post-irradiation.

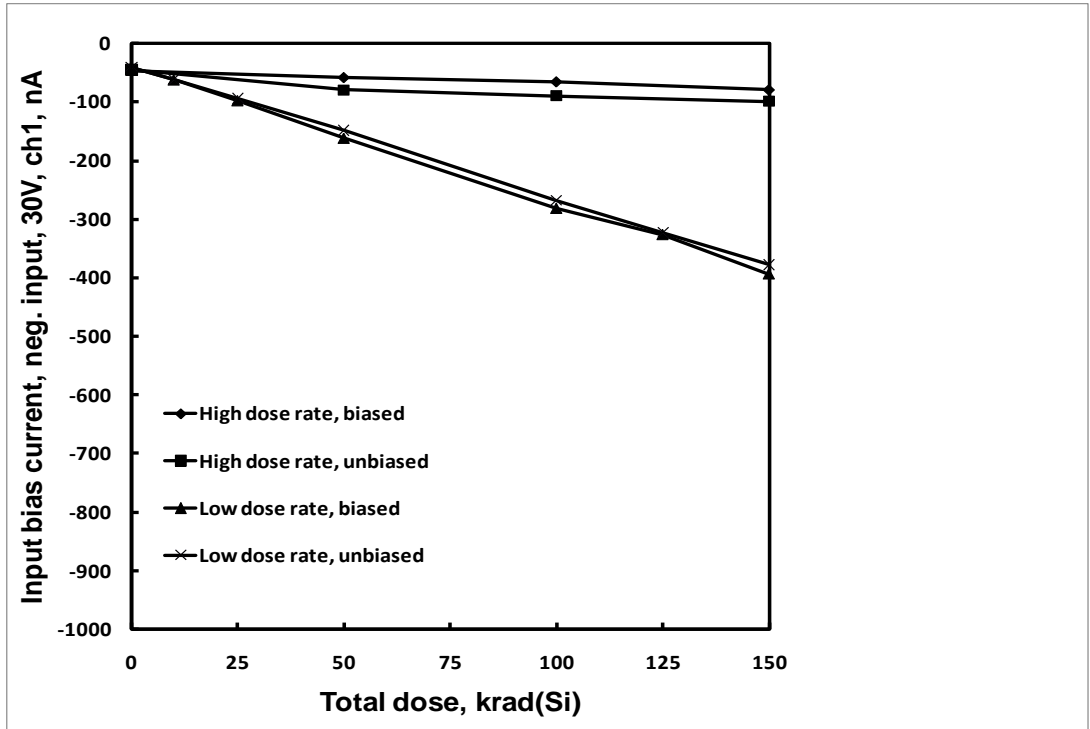

Figure 9: HS-139RH negative input bias current at 30V supply, channel 1, as a function of total dose irradiation at low and high dose rate. The low dose rate was .01rad(Si)/s and the high dose rate was 55rad(Si)/s. Sample size for each cell was 5. The SMD limit for this parameter is 1 μ A post-irradiation.

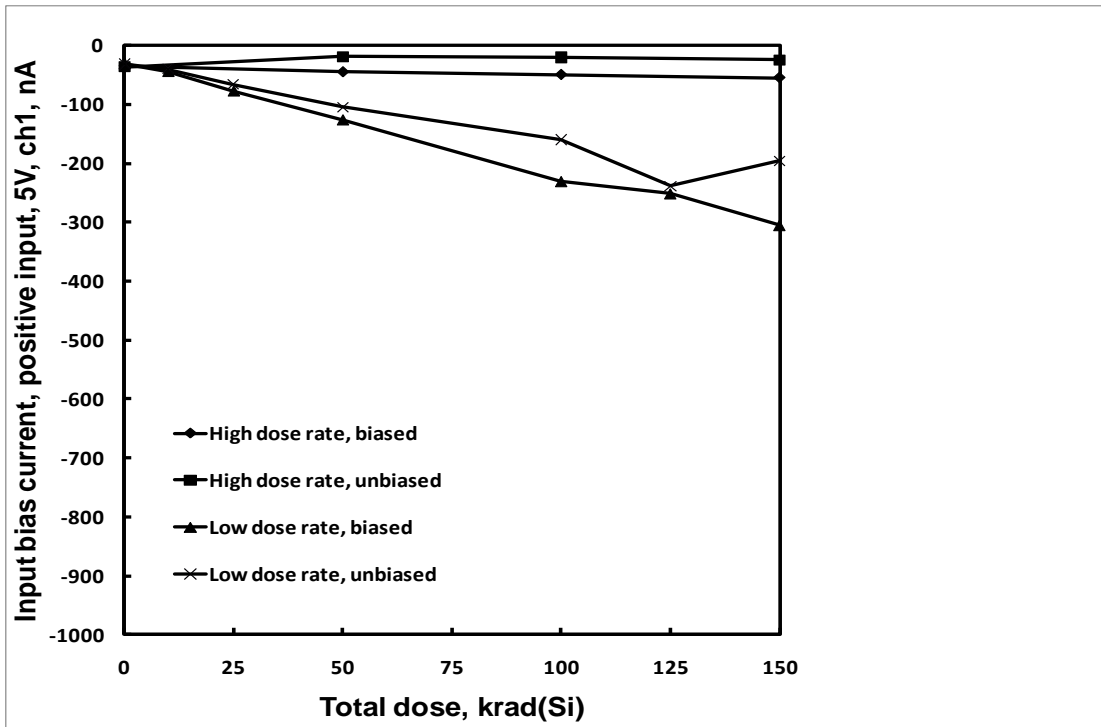

Figure 10: HS-139RH positive input bias current at 5V supply, channel 1, as a function of total dose irradiation at low and high dose rate. The low dose rate was .01rad(Si)/s and the high dose rate was 55rad(Si)/s. Sample size for each cell was 5. The SMD limit for this parameter is 1 μ A post-irradiation.

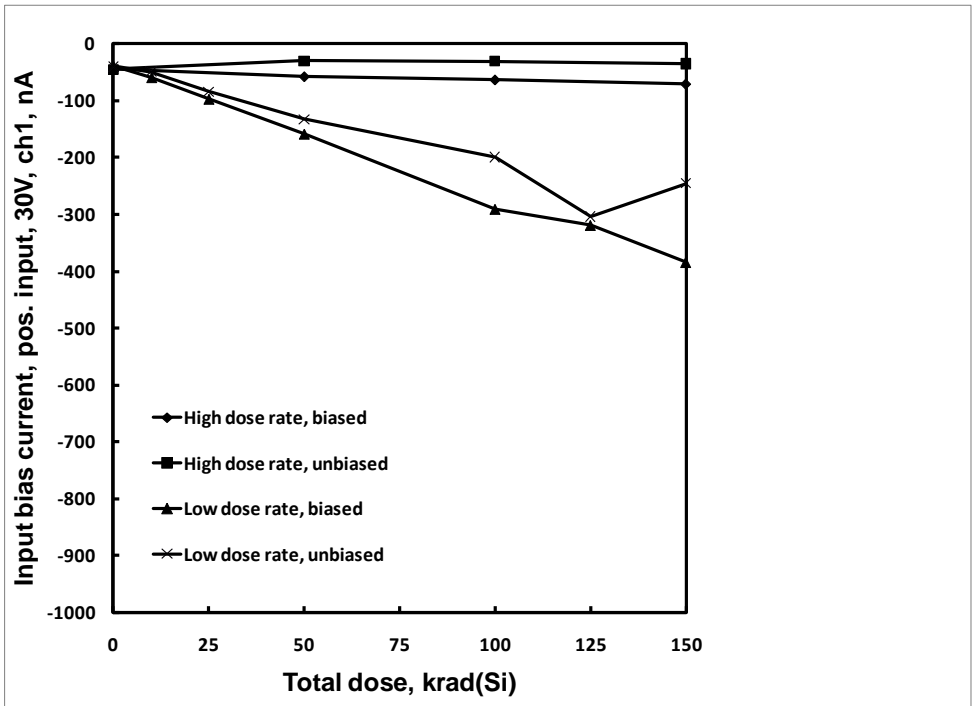

Figure 11: HS-139RH positive input bias current at 30V supply, channel 1, as a function of total dose irradiation at low and high dose rate. The low dose rate was .01rad(Si)/s and the high dose rate was 55rad(Si)/s. Sample size for each cell was 5. The SMD limit for this parameter is 1 μ A post-irradiation.

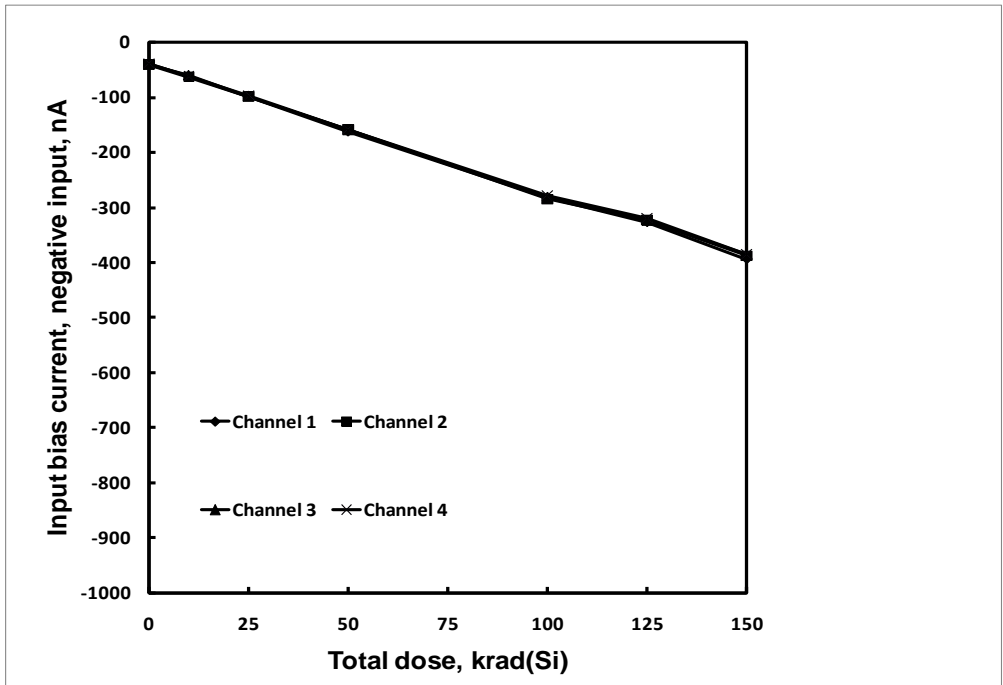

Figure 12: HS-139RH negative input bias current at 30V supply, channels 1 through 4, as a function of total dose irradiation at low dose rate of .01rad(Si)/s, unbiased irradiation. The SMD limit for this parameter is 1 μ A post-irradiation.

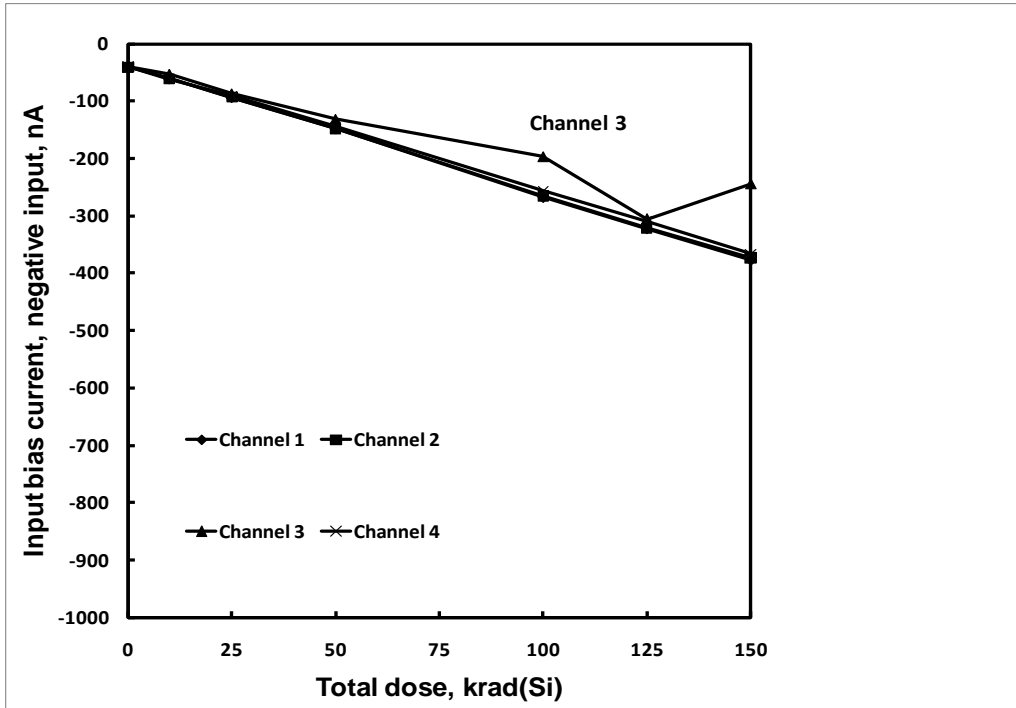

Figure 13: HS-139RH negative input bias current at 30V supply, channels 1 through 4, as a function of total dose irradiation at low dose rate of .01rad(Si)/s, biased irradiation. The SMD limit for this parameter is 1 μ A post-irradiation.

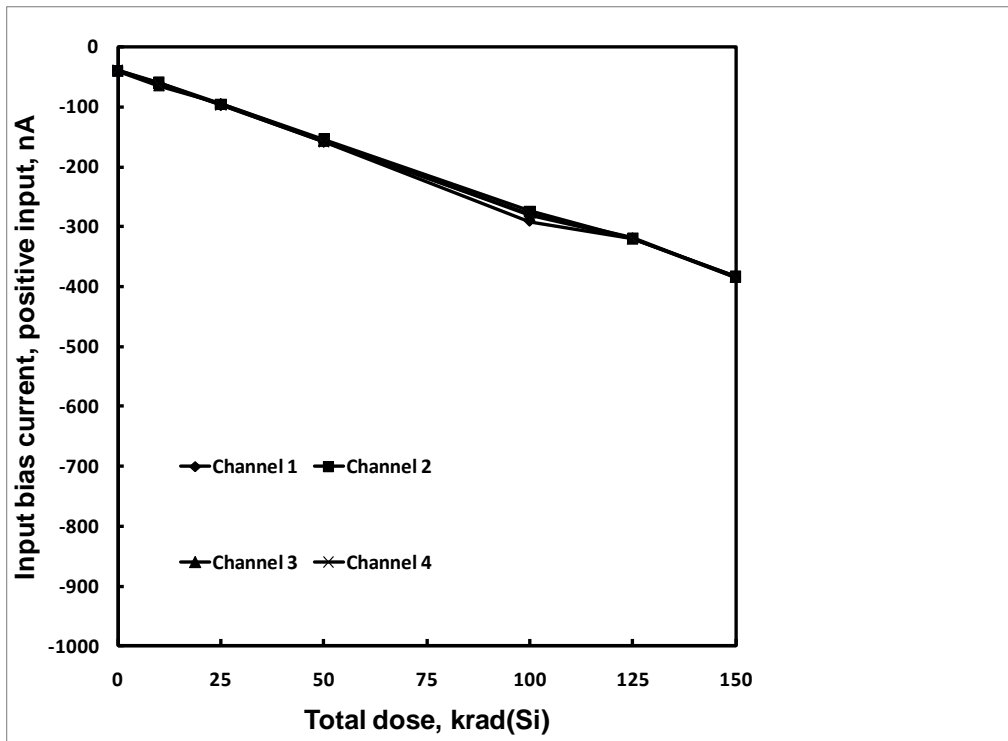

Figure 14: HS-139RH positive input bias current at 30V supply, channels 1 through 4, as a function of total dose irradiation at low dose rate of .01rad(Si)/s, unbiased irradiation. The SMD limit for this parameter is 1 μ A post-irradiation.

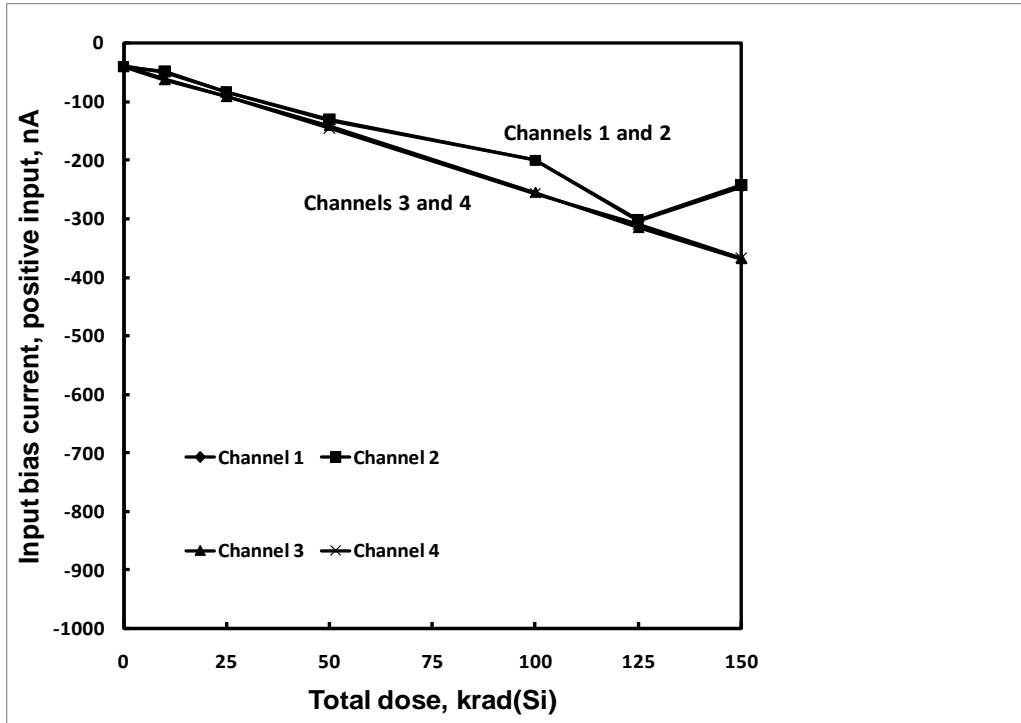

Figure 15: HS-139RH positive input bias current at 30V supply, channels 1 through 4, as a function of total dose irradiation at low dose rate of .01rad(Si)/s, biased irradiation. The SMD limit for this parameter is 1 μ A post-irradiation.

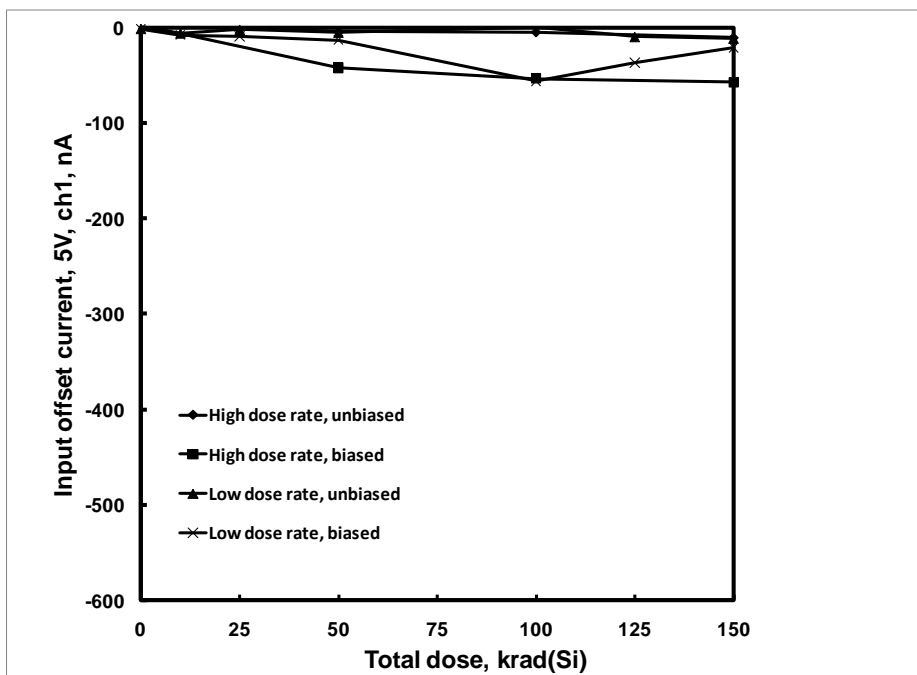

Figure 16: HS-139RH input offset current at 5V supply, channel 1, as a function of total dose irradiation at low and high dose rate. The low dose rate was .01rad(Si)/s and the high dose rate was 55rad(Si)/s. Sample size for each cell was 5. The SMD limit for this parameter is +/-600nA post-irradiation.

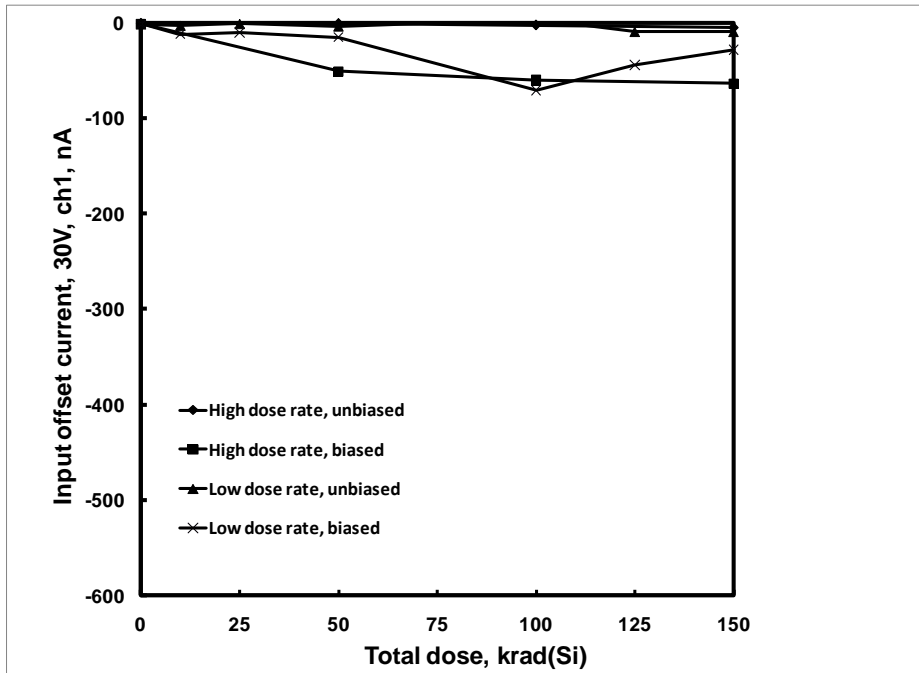

Figure 17: HS-139RH input offset current at 30V supply, channel 1, as a function of total dose irradiation at low and high dose rate. The low dose rate was .01rad(Si)/s and the high dose rate was 55rad(Si)/s. Sample size for each cell was 5. The SMD limit for this parameter is +/-600nA post-irradiation.

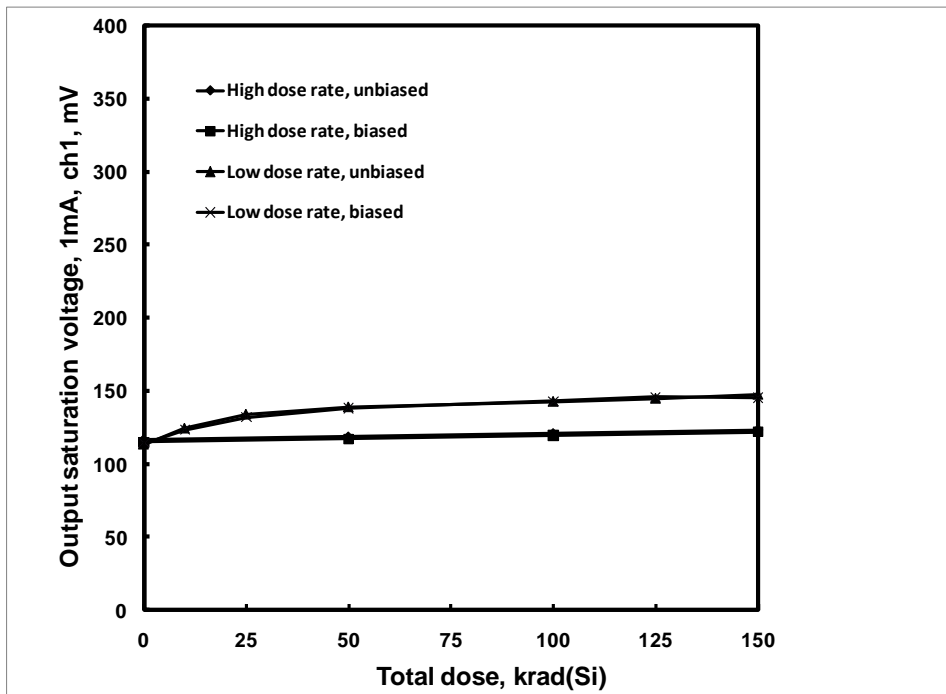

Figure 18: HS-139RH output saturation voltage, channel 1, 1mA output current, as a function of total dose irradiation at low and high dose rate. The low dose rate was .01rad(Si)/s and the high dose rate was 55rad(Si)/s. Sample size for each cell was 5. The SMD limit for this parameter is 400mV post-irradiation.

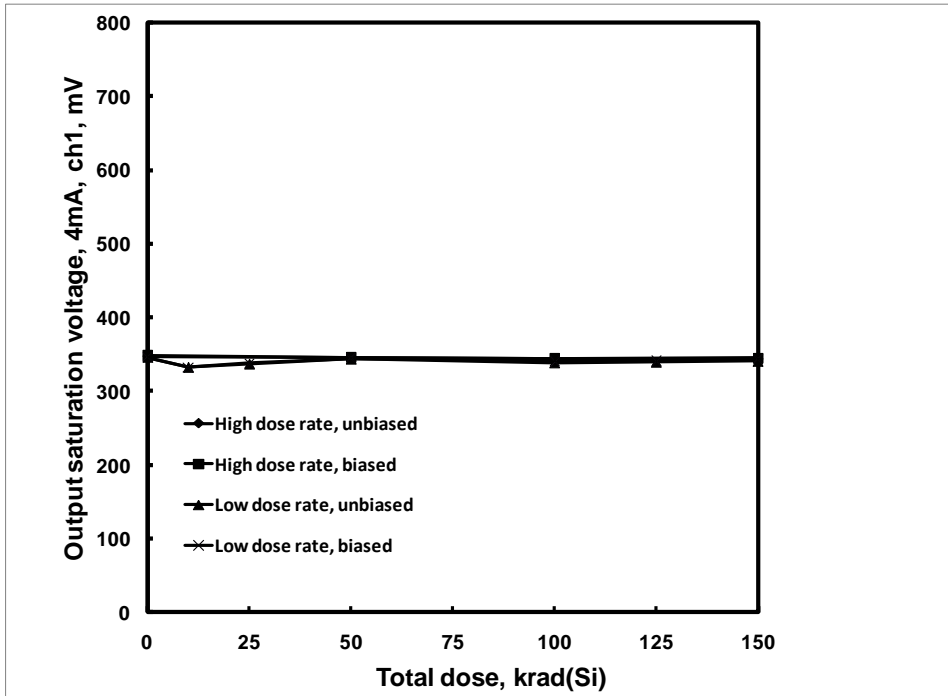

Figure 19: HS-139RH output saturation voltage, channel 1, 4mA output current, as a function of total dose irradiation at low and high dose rate. The low dose rate was .01rad(Si)/s and the high dose rate was 55rad(Si)/s. Sample size for each cell was 5. The SMD limit for this parameter is 800mV post-irradiation.

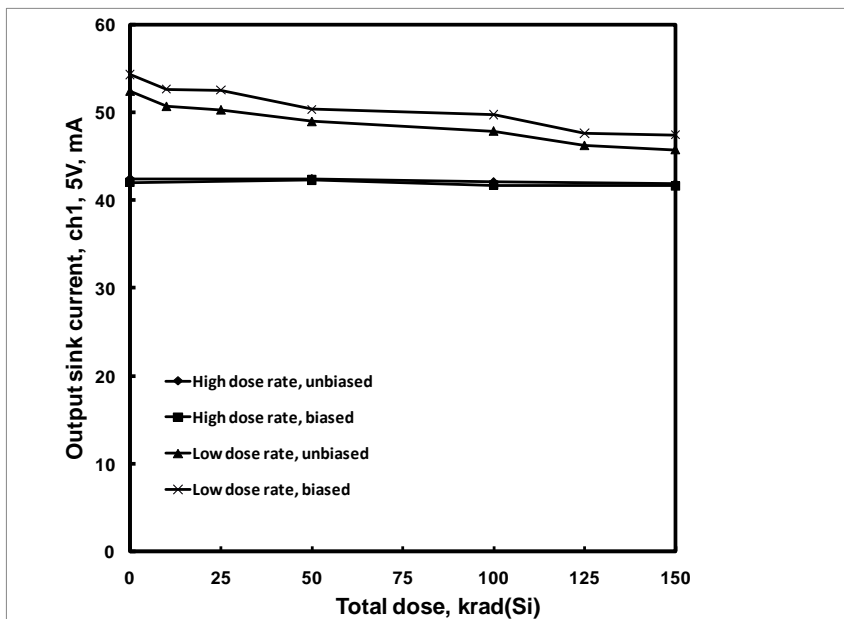

Figure 20: HS-139RH output sink current at 5V supply, channel 1, as a function of total dose irradiation at low and high dose rate. The low dose rate was .01rad(Si)/s and the high dose rate was 55rad(Si)/s. Sample size for each cell was 5. The SMD limit for this parameter is 6mA post-irradiation.

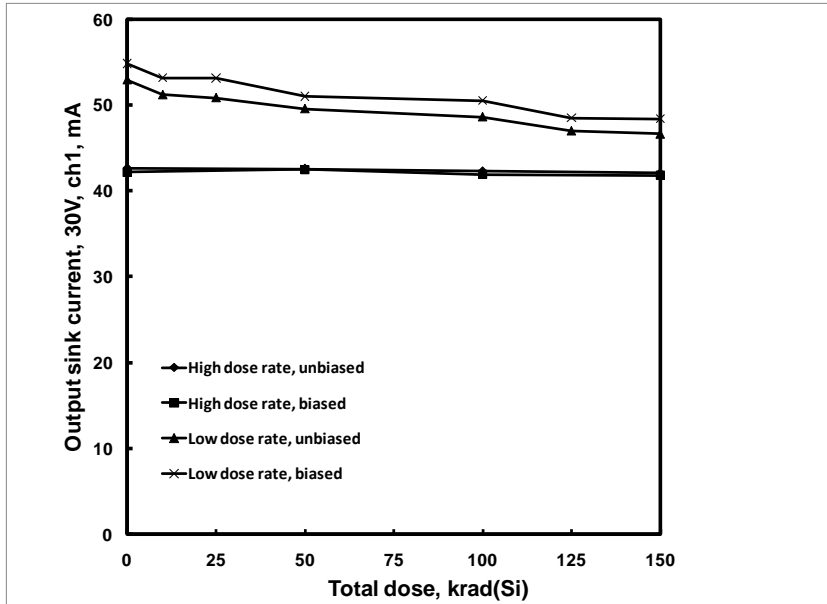

Figure 21: HS-139RH output sink current at 30V supply, channel 1, as a function of total dose irradiation at low and high dose rate. The low dose rate was .01rad(Si)/s and the high dose rate was 55rad(Si)/s. Sample size for each cell was 5. The SMD limit for this parameter is 6mA post-irradiation.

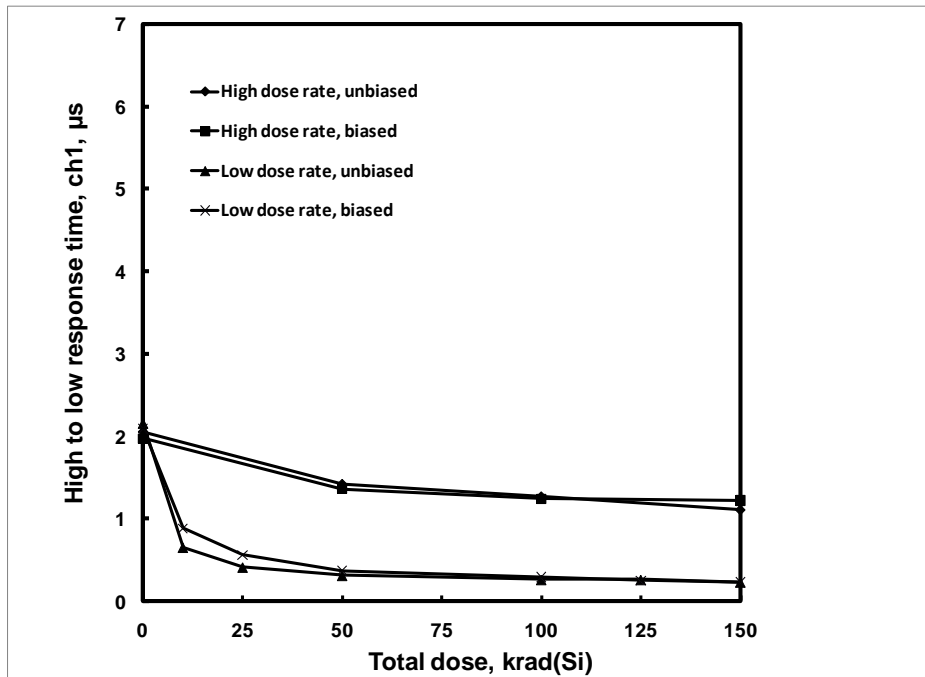

Figure 22: HS-139RH high to low response time as a function of total dose irradiation at low and high dose rate. The low dose rate was .01rad(Si)/s and the high dose rate was 55rad(Si)/s. Sample size for each cell was 4. The SMD limit for this parameter is 7μs maximum.

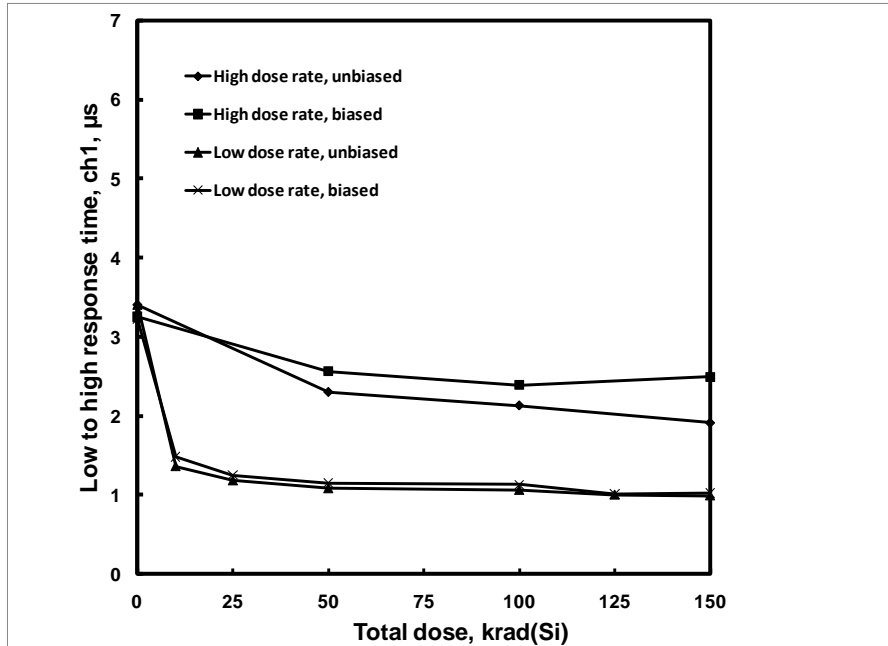

Figure 23: HS-139RH low to high response time as a function of total dose irradiation at low and high dose rate. The low dose rate was .01rad(Si)/s and the high dose rate was 55rad(Si)/s. Sample size for each cell was 4. The SMD limit for this parameter is 7 μ s maximum.

6: Discussion

ATE characterization of the samples at all downpoints showed no rejects tot the SMD post-irradiation limits. The data is plotted in figures 3 to 23 and generally showed good stability over total dose irradiation.

The part displayed low dose rate sensitivity, notably in the input bias current parameter. This response is consistent with gain degradation in the input PNP differential pair and has been previously reported in the literature. The input bias current increase is monotonic as a function of dose and is very linear. The worst-case value encountered for this parameter was to the order of 350 nanoamperes, which is a factor of three below the 1 microampere SMD limit. Accordingly, the part is considered low dose rate sensitive up to the 300krad(Si) data sheet total dose rating.

Most other plotted parameters showed minor differences between the high and low dose rate response. The power supply current at both supply voltages was flat over dose. The offset voltage and was similarly flat over dose, indicating that while the gain of the input PNP pair degrades with dose, it remains well matched. The offset current was also flat over dose, indicating that the gain degradation of the input PNP pair is also well matched.

The output saturation voltage and the output sink current are large signal parameters and remained very stable. It is interesting to note the response time plots, both high to low and low to high. This parameter was flat with a reduction of approximately 500ns over the 150krad(Si) of high dose irradiation. At low dose rate, the response time fell to about 200ns from an initial 2 μ s, and then remained constant at that value for the remainder of the test. The mechanism for this is not fully understood.

The HS-139RH is a quad device. Like most IC implementations of multiple devices, the individual layout design of each channel is identical, and great care is taken to eliminate channel to channel variations due to interconnect parasitic. The data showed little variation between channels, as expected. Figures 12 through 15 explore possible channel sensitivity of the input bias current variation as a function of total dose. The figures plot the input bias current for all four channels as a function of dose for the 5V and 30V supply cases and for

the biased and unbiased cases, all at low dose rate. We chose low dose rate for this analysis as the input bias is the most sensitive to this condition. No systemic channel sensitivity was noted.

7: Conclusion

This document reports the results of a total dose test of the HS-139RH quad voltage comparator. Samples were tested under biased and unbiased conditions to a maximum total dose of 150krad(Si) at high and low dose rate.

The part showed considerable difference between the low and high dose rate response, largely in the input bias current parameter. This response is consistent with gain degradation in the input PNP differential pair and has been previously reported in the literature. The input bias current increase is monotonic as a function of dose and is very linear. The worst-case value encountered for this parameter was to the order of 350 nanoamperes, which is a factor of three below the 1 microampere SMD limit. Accordingly, the part is considered low dose rate sensitive up to the 300krad(Si) data sheet total dose rating.

We did not observe a great deal of difference between the response to biased and unbiased irradiation, and the part is not considered bias sensitive.

7: Appendices

None.

8: Document revision history

Revision	Date	Pages	Comments
0	28 May 2010	All	Original issue
1	14 June 2010	All	Figure changes