

78K0/Ix2 High brightness LED controlling Software reference design 78K0/IB2 HBLEDD evaluation board (EZ-0005)

Contents

Chapter 1 Introduction ... 3

1.1 Brief introduction on controlling ... 3

1.2 Initialization ... 4

1.3 Main loop ... 5

Chapter 2 Software ... 7

2.1 File Configuration ... 7

2.2 Internal Peripheral Functions to Be Used ... 8

2.3 Initialization settings ... 8

2.4 Flow chart ... 9

Chapter 3 Setting methods ... 11

3.1 Parameter descriptions ... 11

3.2 Register setting ... 12

Chapter 4 Operation check using EZ-0005 ... 17

ZBB-CE-09-0036-E

Data Published June 2009

© NEC Electronics Corporation

- The information in this document is current as of June , 2009. The information is subject to change without notice. For actual design-in, refer to the latest publications of NEC Electronics data sheets or data books, etc., for the most up-to-date specifications of NEC Electronics products. Not all products and/or types are available in every country. Please check with an NEC Electronics sales representative for availability and additional information.
- No part of this document may be copied or reproduced in any form or by any means without the prior written consent of NEC Electronics. NEC Electronics assumes no responsibility for any errors that may appear in this document.
- NEC Electronics does not assume any liability for infringement of patents, copyrights or other intellectual property rights of third parties by or arising from the use of NEC Electronics products listed in this document or any other liability arising from the use of such products. No license, express, implied or otherwise, is granted under any patents, copyrights or other intellectual property rights of NEC Electronics or others.
- Descriptions of circuits, software and other related information in this document are provided for illustrative purposes in semiconductor product operation and application examples. The incorporation of these circuits, software and information in the design of a customer's equipment shall be done under the full responsibility of the customer. NEC Electronics assumes no responsibility for any losses incurred by customers or third parties arising from the use of these circuits, software and information.
- While NEC Electronics endeavors to enhance the quality, reliability and safety of NEC Electronics products, customers agree and acknowledge that the possibility of defects thereof cannot be eliminated entirely. To minimize risks of damage to property or injury (including death) to persons arising from defects in NEC Electronics products, customers must incorporate sufficient safety measures in their design, such as redundancy, fire-containment and anti-failure features.
- NEC Electronics products are classified into the following three quality grades: "Standard", "Special" and "Specific".
The "Specific" quality grade applies only to NEC Electronics products developed based on a customer-designated "quality assurance program" for a specific application. The recommended applications of an NEC Electronics product depend on its quality grade, as indicated below. Customers must check the quality grade of each NEC Electronics product before using it in a particular application.
 - "Standard": Computers, office equipment, communications equipment, test and measurement equipment, audio and visual equipment, home electronic appliances, machine tools, personal electronic equipment and industrial robots.
 - "Special": Transportation equipment (automobiles, trains, ships, etc.), traffic control systems, anti-disaster systems, anti-crime systems, safety equipment and medical equipment (not specifically designed for life support).
 - "Specific": Aircraft, aerospace equipment, submersible repeaters, nuclear reactor control systems, life support systems and medical equipment for life support, etc.
- The quality grade of NEC Electronics products is "Standard" unless otherwise expressly specified in NEC Electronics data sheets or data books, etc. If customers wish to use NEC Electronics products in applications not intended by NEC Electronics, they must contact an NEC Electronics sales representative in advance to determine NEC Electronics' willingness to support a given application.

(Note)

- (1) "NEC Electronics" as used in this statement means NEC Electronics Corporation and also includes its majority-owned subsidiaries.
- (2) "NEC Electronics products" means any product developed or manufactured by or for NEC Electronics (as defined above).

Chapter 1 Introduction

This sample program is a reference of controlling high brightness LED by using a 78K0/Ix2 microcontroller. It presents the way of constant current control for 3 channels of LEDs independently as well as the dimming for them by variable resistors.

This program can be evaluated by a 78K0/IB2 HBLED evaluation board(EZ-0005). Please find the pin configurations in the schematic of 78K0/IB2 HBLED evaluation board(EZ-0005).Please refer to the application note “Controlling High Brightness LED by using 78K0/Ix2” (U19666) for the control method and circuit designing information.

1.1 Brief introduction on controlling

There mounts 3 high brightness LED(R, G, B) which are driven by buck converter circuit on EZ-0005 board.

The current of LED is measured by the A/D converter from a sense resistor and compared with the reference level to adjust the PWM duty, which cause the current becomes closer to the reference level. This continuous feedback realizes constant current control.

The voltage set by variable resistors is measured by A/D converter to set the reference level for constant current control. It realized the dimming operation of LEDs.

Figure 1-1 buck converter topology

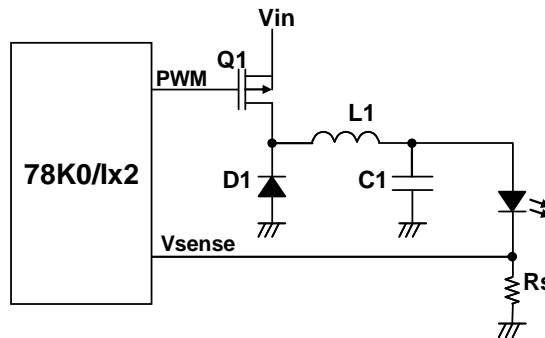
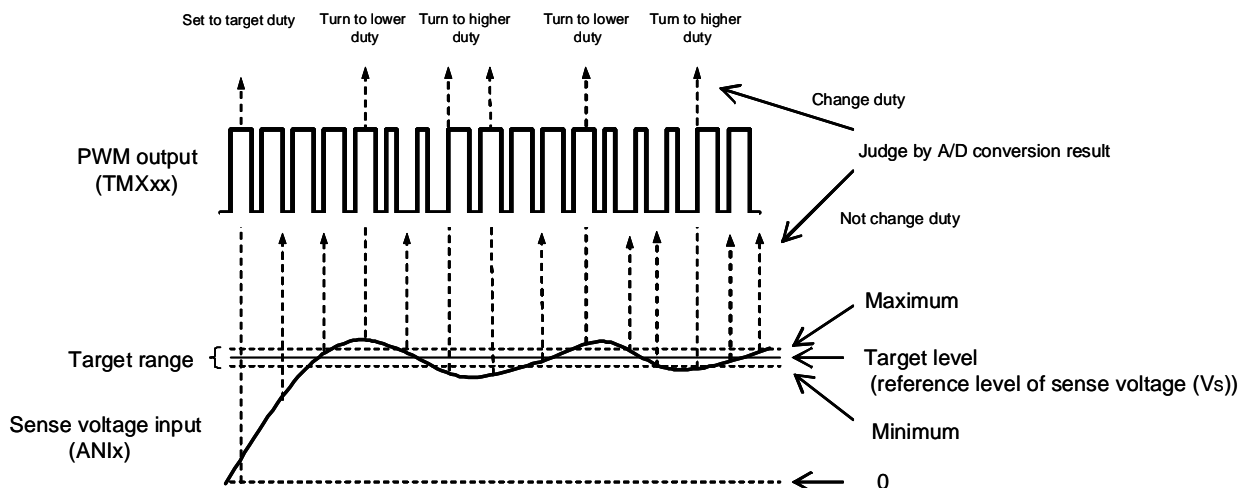

Figure 1-2 Example of integrated A/D Converter Feedback



1.2 Initialization

The main contents of the initial settings are as follows.

(1) Option byte setting

- Selecting the high-speed internal oscillator (4MHz) as the system clock source
- Stopping watchdog timer operation
- Not shifting to on-chip debug mode after reset release

(2) Program setting

- I/O port setting
- LVI (Low-voltage detector circuit) setting
 - Setting V_{LVI} (low-voltage detection voltage) to $4.3 V \pm 0.2 V$
 - Generating an internal reset (LVI reset) signal when it is detected that VDD is less than V_{LVI} , after VDD (power supply voltage) becomes greater than or equal to V_{LVI}
- Setting CPU clock frequency to 20MHz (10 times the internal high-speed oscillation clock (f_{IH}) x1/2)
- 16 bit timer X0, X1 setting
 - Setting count clock to f_{TMX} ($f_{TMX} = 10f_{XP}$) (40 MHz)
 - Setting output default status of TOX00, TOX01 and TOX10 to low level
 - Setting output of TOX00, TOX01 and TOX10 to be prohibited
 - Setting output operation of TMX0 and TMX1 to dual
 - Setting frequency of PWM output to $156.25\text{kHz} (f/(TXnCR3+1), n=0,1)$
 - Masking the interrupt INTTMX0, INTTMX1
- 8 bit timer 51
 - Setting count clock to $f_{PRS}/2^8$ (78.13kHz)
 - Setting the interval time to $3.3\text{ms} ((CR51+1)/f)$
 - Masking the interrupt INTTM51
- A/D converter setting
 - Setting A/D converting time to 8.8us
 - Enable interrupt INTAD

1.3 Main loop

TMX, TM51 and A/D converter start after initialization. Usually, analog input channel is specified to be one of the LED feedback channel. When the operation starts, the microcontroller checks the A/D converter interrupt flag (ADIF). It starts feedback operation when the flag is on, and then keeps the current constant by adjusting duty of PWM. Every 3.3ms, the interrupt of TM51 (INTTM51) occurs and analog input channel turns to the volume temporarily. Voltage for dimming (target level) is calculated by the A/D result in this period.

In the feedback process of channel n^{note1} , the result of A/D converter ($\text{ushgetvalue}^{\text{note2}}$) is compared with the last result ($\text{ushlstvalueCHn}^{\text{note1}}$) and the target level (ushreflevn).

- When sense voltage increased or kept the same and it exceeds the upper limit of target level ($\text{ushreflevn}^{\text{note1}} + \text{upperlimit}$), set the duty of PWM lower.
- When sense voltage decreased or kept the same and it falls below the lower limit of target level ($\text{ushreflevn}^{\text{note1}} - \text{lowerlimit}$), set the duty of PWM higher.

By using this feedback process, the sense voltage can approach to the target level. If the target level radically changed, the feedback process may be executed more than once before the sense voltage reach the target. To avoid a feedback opposite expected direction or a peak pulse caused by excess of feedback. The sense voltage is only compared with the upper limit when increasing and only compared with the lower limit when decreasing (hysteresis is gifted).

In the process of volume n^{note1} , the result of A/D converter (ushgetvalue) is used to calculate the dimming step ($\text{stepn}^{\text{note1}}$), which presents the brightness of LED. In this sample program, there defined 28 steps of dimming step. With a 10 bit A/D converter, the step can be calculated as following formula.

$$\text{Stepn}^{\text{note1}} = \text{ushgetvalue} \times 28 / 1024$$

* Ignore the fractional part

The dimming step is used as an argument of dimming function (`void change_vrefnnote1(short level)`).

note1 : $n = 0, 1, 2$. On the board EZ-0005, CH0 is Red, CH1 is Green, CH2 is Blue.

note2 : The parentheses show some global variable in the sample program. Please refer to “**3.1 parameter descriptions**” for definition of all global variables.

Analog input channel is set to be shifted at the bottom of the main loop. The microcontroller checks the flag of TM51's interrupt (TMIF51) which occurs every 3.3ms. When the flag is ON, set the Analog input channel to volume input; when the flag is OFF, set the analog input channel to feedback channel.

The analog input channel shifts as the following rule.

Figure 1-3 Shifting rule of analog input channel in main loop

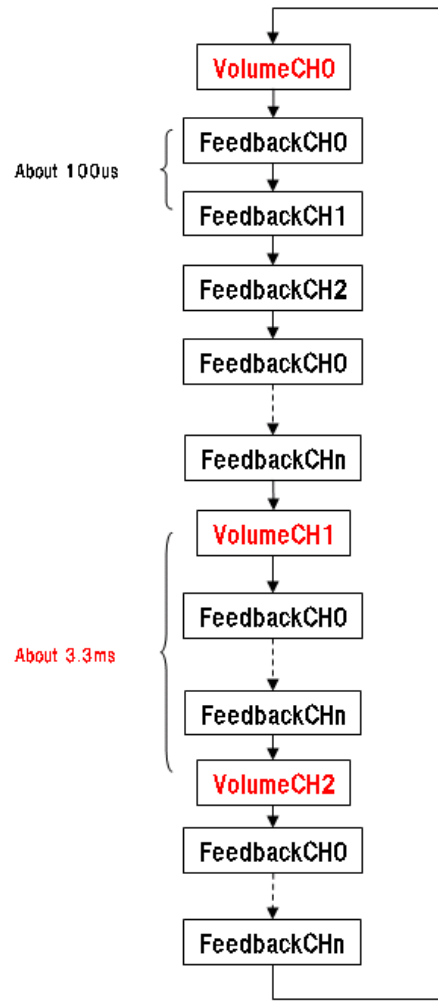

Chapter 2 Software

This chapter describes the file configuration of the compressed file to be downloaded, internal peripheral functions of the microcontroller to be used and initial settings and operation overview of the sample program, and shows a flow chart.

2.1 File Configuration

The following table shows the file configuration of the compressed file to be downloaded.

Figure 2-1 file configuration and function

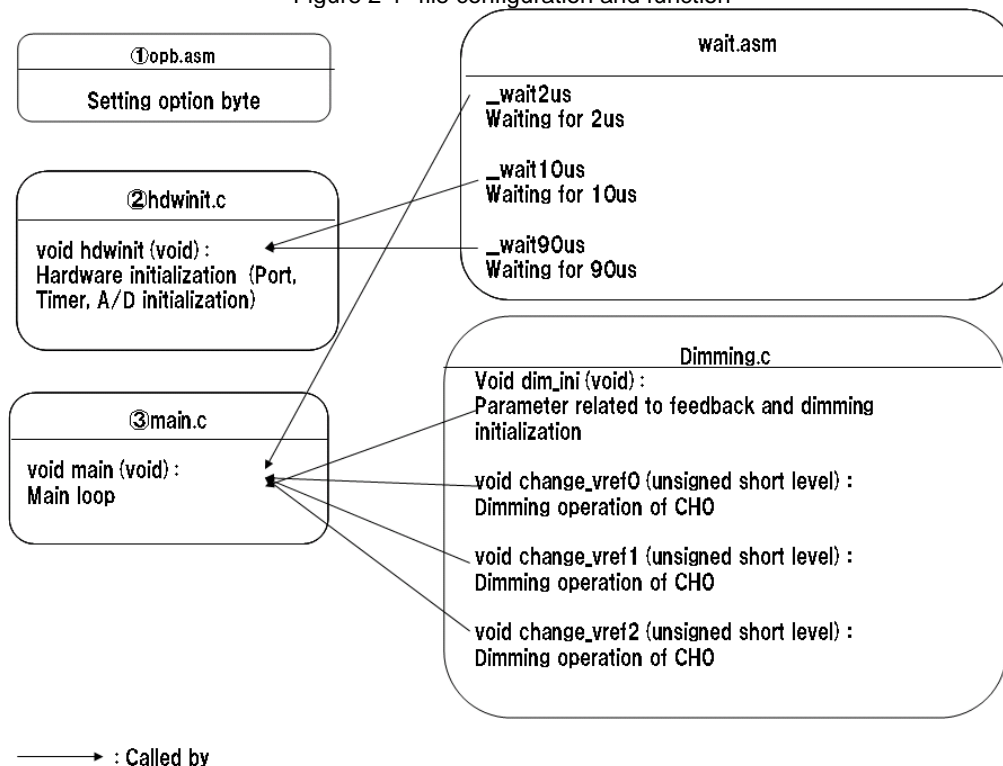

2. 2 Internal Peripheral Functions to Be Used

The following internal peripheral functions of the microcontroller are used in this sample program.

- PWM output function: 16bit timer X0, X1
- Volume input: A/D converter channel_n (n=6~8)
- LED current feedback input: A/D converter channel_m (m=3~5)

Table 2-1 A/D converter channels specification

Analog input channel	usage
ANI0	Not used
ANI1	Not used
ANI2	Not used
ANI3	Feedback current input of LED CH2
ANI4	Feedback current input of LED CH0
ANI5	Feedback current input of LED CH1
ANI6	Volume input for dimming of LED CH0
ANI7	Volume input for dimming of LED CH1
ANI8	Volume input for dimming of LED CH2

2. 3 Initialization settings

In the initialization setting (function "hdwinit") of this sample program, low voltage detection function, clock frequency, I/O port, 8 bit timer 51 (interval timer), 16bit timer X0, X1 (PWM output) and the interrupts are set .

After initialization settings, the 156.25 kHz PWM signal is output by the 16 bit timer X0, X1 to drive the LED. A/D converter detects the sense voltage from feedback input pin, compares it with the target level and adjusts the duty of PWM.

With the interrupt of 8 bit timer 51 (INTTM51), volume input is converted every 3.3ms. A/D target level for feedback is adjusted to realize LED dimming according to the volume input.

2.4 Flow chart

Figure 2-2 Main loop

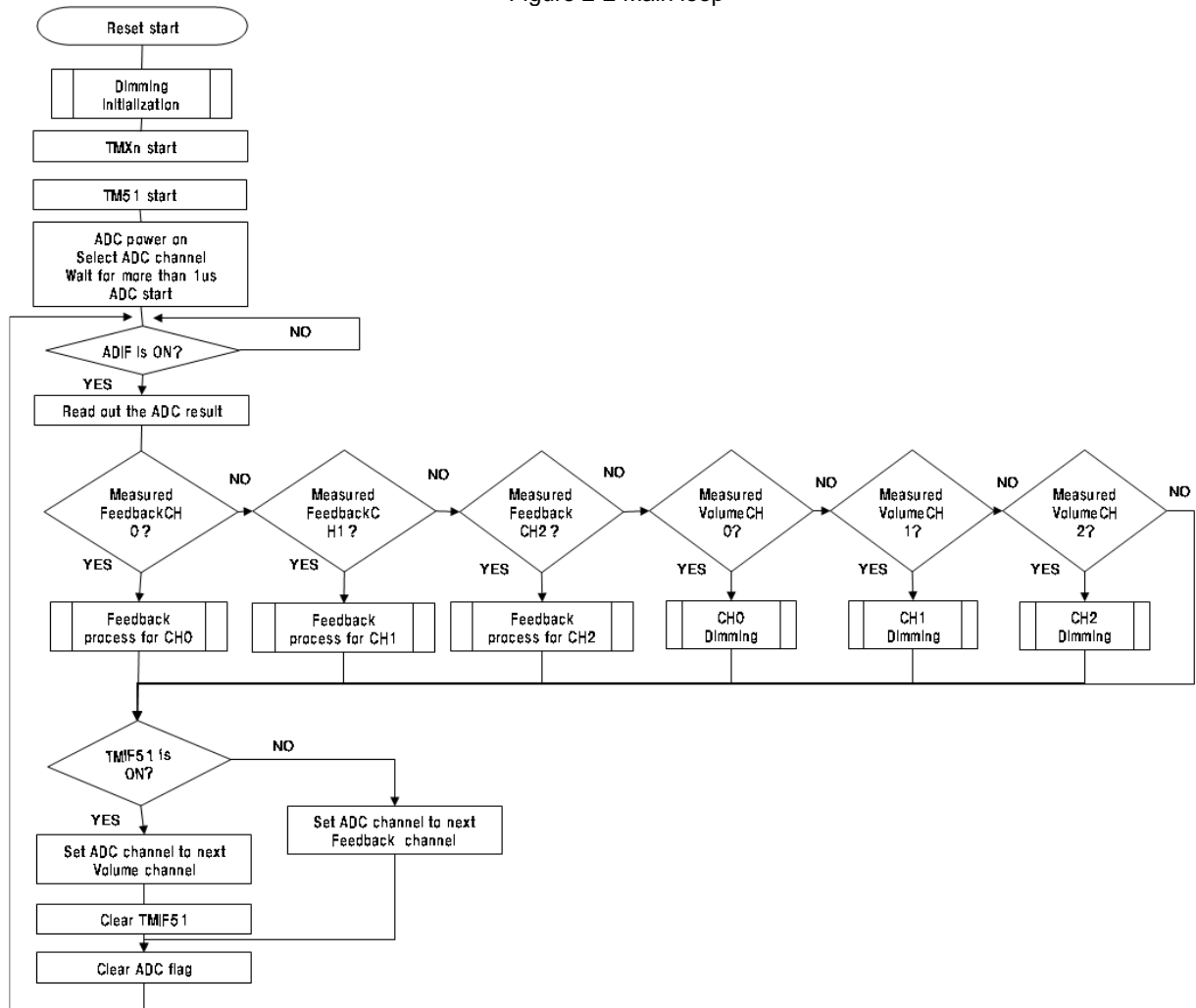

Figure 2-3 CHn Feedback processing (n=0,1,2)

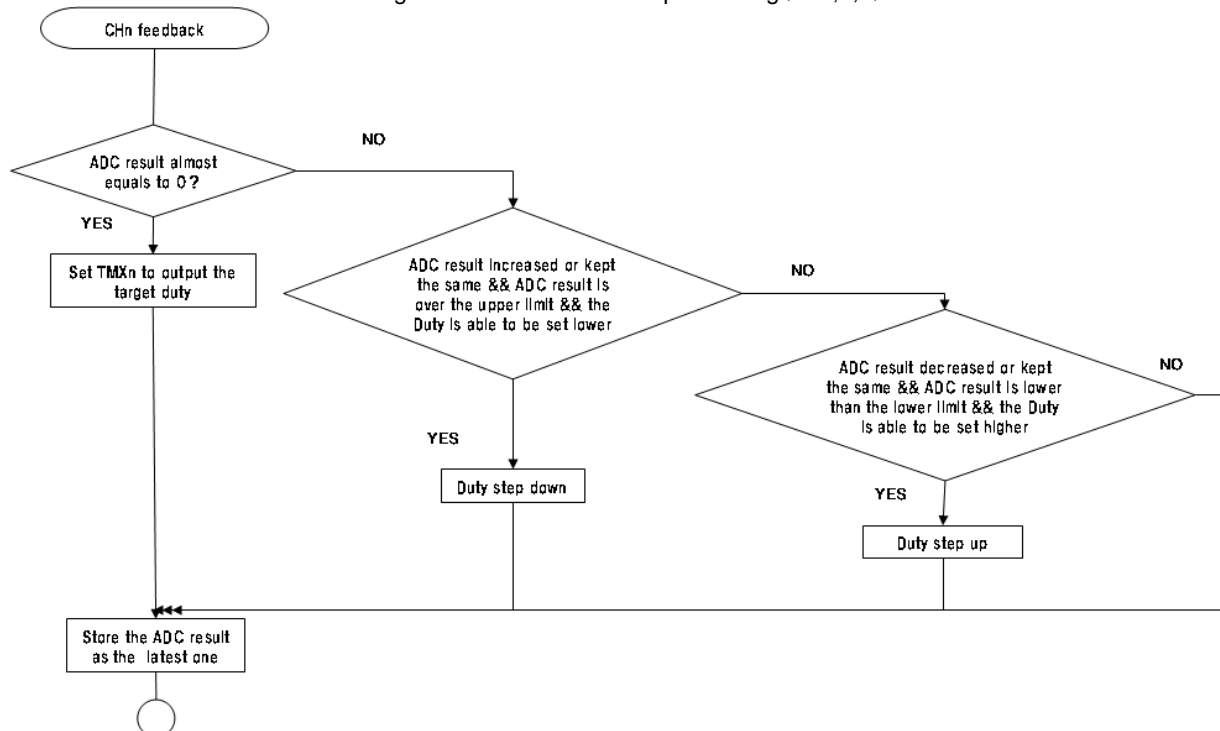
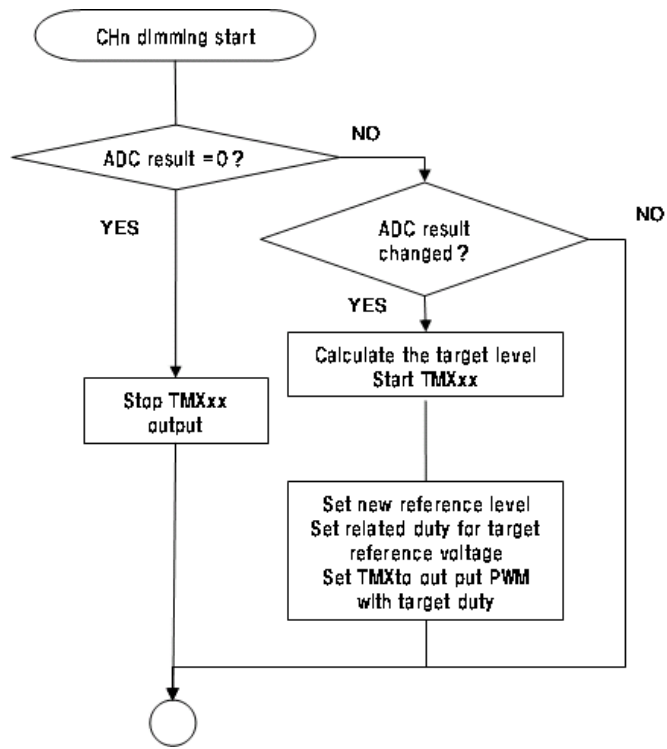

Figure 2-4 CHn dimming processing (n=0,1,2)



Chapter 3 Setting methods

3.1 Parameter descriptions

Table 3-1 Global variable list (defined in: Main.c)

Data type	Variable name	Description
Unsigned short	ushgetvalue	save the latest A/D result
Unsigned short	ushlstvalueCH0	save the last A/D result for feedback of CH0
Unsigned short	ushlstvalueCH1	save the last A/D result for feedback of CH1
Unsigned short	ushlstvalueCH2	save the last A/D result for feedback of CH2
Unsigned short	ushreflev0	save the reference A/D value for target feedback voltage, CH0
Unsigned short	ushreflev1	save the reference A/D value for target feedback voltage, CH1
Unsigned short	ushreflev2	save the reference A/D value for target feedback voltage, CH2
Unsigned short	step0	argument of the dimming function void change_vref0(level)
Unsigned short	step1	argument of the dimming function void change_vref1(level)
Unsigned short	step2	argument of the dimming function void change_vref2(level)
Unsigned short	ushlstvolumeCH0	save last A/D result for Volume of CH0
Unsigned short	ushlstvolumeCH1	save last A/D result for Volume of CH1
Unsigned short	ushlstvolumeCH2	save last A/D result for Volume of CH2
Unsigned char	ucduty0	save the value for the register setting of the PWM output, CH0
Unsigned char	ucduty1	save the value for the register setting of the PWM output, CH1
Unsigned char	ucduty2	save the value for the register setting of the PWM output, CH2
Unsigned char	ucvolcn	save the volume channel number

Table 3-2 Constant table for feedback (defined in: dimming.c)^{note}

Data type	Variable	Deception
static const unsigned short	ADref[28]	Reference A/D value for the target voltage between 0V and 1.4V divided by 0.05V in all
static const unsigned char	DUTYref0[28]	Reference value of TMX0 register for the duty of CH0 which is related to each target voltage
static const unsigned char	DUTYref1[28]	Reference value of TMX0 register for the duty of CH1 which is related to each target voltage
static const unsigned char	DUTYref2[28]	Reference value of TMX1 register for the duty of CH2 which is related to each target voltage

Note: There mounted three LEDs(R,G,B) on the EZ-0005 evaluation board. Value in this table is not guaranteed because it was calculated using experimented results. Please refer to the source code for details.

3.2 Register setting

This chapter describes the setting method of following functions.
 PWM output function of 16bit timer X0, X1
 Interval timer function of 8bit timer 51
 A/D converter

3. 2.1 PWM output function of 16bit timer X0, X1 (Same as in the sample program setting)

- Set 1 count clock to 0.025 μ s (TMX clock operates at 40MHz)
- Set PWM frequency to 156.25KHz

TX0IOC0 (TMX0 output setting)

7	6	5	4	3	2	1	0
0	0	0	0	TX0 TOC1	TX0 TOC0	TX0 TOL1	TX0 TOL0
0	0	0	0	0→1	0→1	0	0

TX0TOL0	Default TOX00 output state setting
0	Normal output (low level)
1	Inverted output (high level)

TX0TOL1	Default TOX01 output state setting
0	Normal output (low level)
1	Inverted output (high level)

TX0TOC0	TOX00 output control
0	Disables timer output (default status)
1	Enables timer output (PWM output)

TX0TOC1	TOX01 output control
0	Disables timer output (default status)
1	Enables timer output (PWM output)

TX1IOC0 (TMX1 output setting)

7	6	5	4	3	2	1	0
0	0	0	0	TX1 TOC1	TX1 TOC0	TX1 TOL1	TX1 TOL0
0	0	0	0	0	0→1	0	0

TX1TOL0	Default TOX10 output state setting
0	Normal output (low level)
1	Inverted output (high level)

TX1TOL1	Default TOX11 output state setting
0	Normal output (low level)
1	Inverted output (high level)

TX1TOC0	TOX10 output control
0	Disables timer output (default status)
1	Enables timer output (PWM output)

TX1TOC1	TOX11 output control
0	Disables timer output (default status)
1	Enables timer output (PWM output)

TX0CTL0 (TMX0 count clock, operation setting)

	7	6	5	4	3	2	1	0
TX0 TMC	0	0	0	0	TX0 CKS2	TX0 CKS1	TX0 CKS0	
	0→1	0	0	0	0	0	0	

TX0CKS2	TX0CKS1	TX0CKS0	PLLSEL=1 is set TMX0 count clock selection
0	0	0	$f_{TMX}(f_{TMX} = 10 f_{XP} = 40MHz)$

TX0TMC	TMX0 count operation control
0	Stops timer count operation (counter is cleared to 0)
1	Enables timer count operation

TX1CTL0 (TMX1 count clock, operation setting)

	7	6	5	4	3	2	1	0
TX1 TMC	0	0	0	0	TX1 CKS2	TX1 CKS1	TX1 CKS0	
	0→1	0	0	0	0	0	0	

TX1CKS2	TX1CKS1	TX1CKS0	PLLSEL=1 is set TMX1 count clock selection
0	0	0	$f_{TMX}(f_{TMX} = 10 f_{XP} = 40MHz)$

TX1TMC	TMX1 count operation control
0	Stops timer count operation (counter is cleared to 0)
1	Enables timer count operation

TX0CTL1 (TMX0 operation setting)

	7	6	5	4	3	2	1	0
TX0 INTPST	0	TX0PWM CE	TX0PWM CINV	TX0PWM	0	0	0	
0	0	0	0	1	0	0	0	

TX0PWM	TMX0 PWM output operation setting
0	Single output (TOX00 pin only)
1	Dual output (TOX00 and TOX01 pins)

TX0PWM CINV	Setting of PWM output gate function by TOH1
0	Performs PWM output while TOH1 output is high level
1	Performs PWM output while TOH1 output is low level

TX0PWM CE	Control of PWM output gate function by TOH1
0	Does not use output gate function
1	Use output gate function

TX0 INTPST	Control of timer start operation via detection of INTP0 valid edge
0	Disables timer start operation via detection of INTP0 valid edge
1	Enables timer start operation via detection of INTP0 valid edge

TX1CTL1 (TMX1 operation setting)

7	6	5	4	3	2	1	0
0	0	TX1PWM CE	0	TX1PWM	0	TX1MD1	TX1MD0
0	0	0	0	1	0	0	0

TX1MD1	TX1MD0	TMX1 operation mode setting
0	0	TMX1-only start mode
0	1	TMX0 and TMX1 Synchronous start mode
1	0	TMX0 and TMX1 Synchronous start/clear mode
1	1	Setting prohibited

TX1PWM	TMX1 PWM output operation setting
0	Single output (TOX10 pin only)
1	Dual output (TOX10 and TOX11 pins)

TX1PWM CE	Control of PWM output gate function by TOH1
0	Does not use output gate function.
1	Use output gate function

Remarks: Because register TX0CTL2, TX1CTL2, TX0CTL3, TX0CTL4 and TX1CTL4 return to 00H when reset, this sample program omit the setting of these registers.

TX0CR3 (TMX0 PWM frequency setting)

1	1	1	1	1	1	1	1
---	---	---	---	---	---	---	---

TX1CR3 (TMX1 PWM frequency setting)

1	1	1	1	1	1	1	1
---	---	---	---	---	---	---	---

$TXnCR3 = 256 - 1 \rightarrow 0.025 \mu s \times 256 = 6.4 \mu s$
 PWM output from TMXn 156.25 kHz

Remarks: Register TXnCR0, TXnCR1 and TXnCR2 return to 00H when reset.

3. 2. 2 Interval timer function of 8bit timer 51 (Same as in the sample program setting)

- Set 1 count clock to 12.8 μ s (operates at 20MHz by PLL function)
- Set the interval timer to about 3.3ms

TCL51 (TM51 count clock selection)

7	6	5	4	3	2	1	0
0	0	0	0	0	TCL512	TCL511	TCL510
0	0	0	0	0	1	1	0

PLLSEL=1 is set

TCL512	TCL511	TCL510	Select count clock of TM51
1	1	0	$f_{PRS}/2^8$ (78.13kHz)

TMC51 (TM51 count operation control)

7	6	5	4	3	2	1	0
TCE51	0	0	0	0	0	0	0
0→1	0	0	0	0	1	1	0

TCE51	TM51 count operation control
0	Counter operation stop (clearing to 0)
1	Count operation start

Remarks: Because register TMC51 returns to 00H when reset, this sample program omit the setting of these registers during initialization.

CR51

1	1	1	1	1	1	1	1
---	---	---	---	---	---	---	---

$$CR51 = 256 - 1 \rightarrow 12.8 \mu s \times 256 = 3.28 ms$$

3. 2.3 A/D converter (Same as in the sample program setting)

Set the conversion time of A/D converter to 8.8us. (Clock frequency(f_{XP})= 20 MHz)

ADM0 (A/D converter mode selection)

7	6	5	4	3	2	1	0
ADCS	0	FR2	FR1	FR0	LV1	LV0	ADCE
0→1	0	0	0	0	1	1	0→1

ADCE	A/D voltage comparator operation control
0	Stops A/D voltage comparator operation
1	Enables A/D voltage comparator operation

4.0 V □ AVREF □ 5.5 V, PLLSEL=1 is set

Mode	Conversion Time Selection	Conversion Clock
0 0 0 1 1	Standard	176/f_{PRS} (8.8us)
		f_{PRS}/8

ADCS	A/D conversion operation control
0	Stops conversion operation
1	Enables conversion operation

ADS (Analog input channel specification register)

7	6	5	4	3	2	1	0
V12SEL	ADOAS	ADTRG1	ADTRG0	ADS3	ADS2	ADS1	ADS0
0	0	0	0	0→1	0→1	0→1	0→1

0	0	0	0	0	0	ANI0
0	0	0	0	0	1	ANI1
0	0	0	0	1	0	ANI2
0	0	0	0	1	1	ANI3
0	0	0	1	0	0	ANI4
0	0	0	1	0	1	ANI5
0	0	0	1	1	0	ANI6
0	0	0	1	1	1	ANI7
0	0	1	0	0	0	ANI8
0	1	x	x	x	x	PGAIN
1	x	x	x	x	X	Internal voltage (1.2 V)
Other than above						Setting prohibited

ADTRG1	ADTRG0	A/D conversion start method selection
0	0	Normal start (software trigger mode)
0	1	TMX0 synchronization
1	0	TMX1 synchronization
1	1	Setting prohibited

Chapter 4 Operation check using EZ-0005 evaluation board

Before operation checking, please prepare the 5V power supply and software according to the User's Manual of EZ-0005().

- ① Set SW502.1 of this board to "OFF".
- ② Insert 5V power supply.
- ③ Connect this board to PC by using USB cable.
- ④

Figure 4-1 Connection when programming to 78K0/IB2

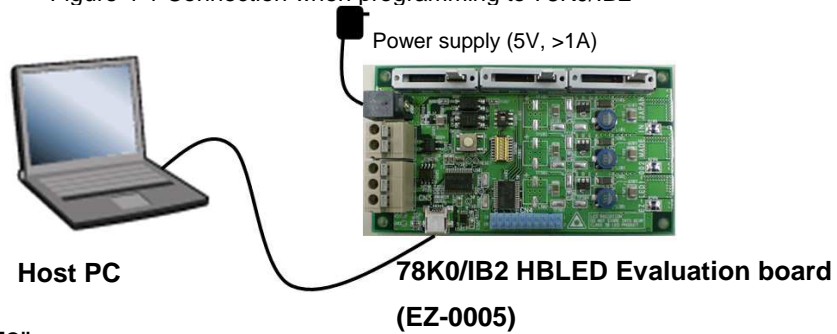

- ⑤ Start up "WriteEZ3"

Figure 4-2 Main window of WriteEZ3

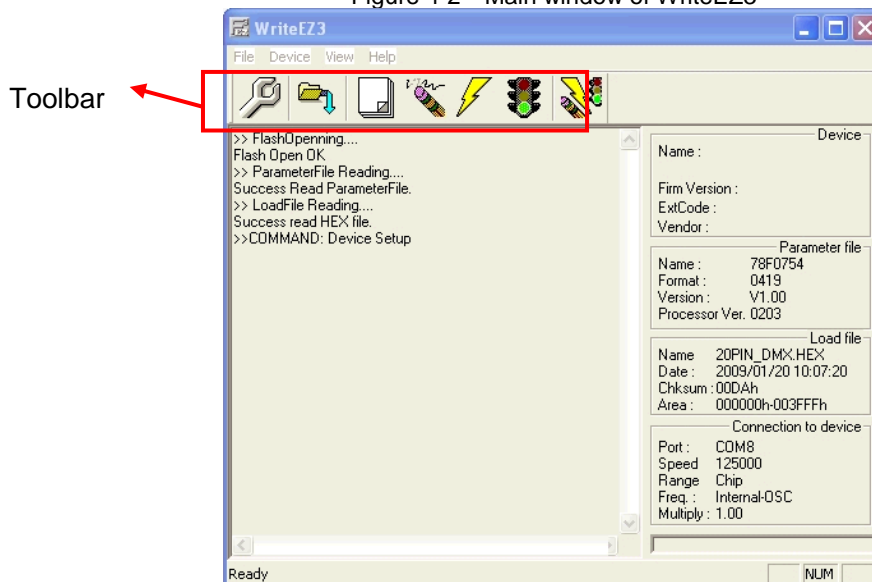

- ⑥ Click [Setup] to open the device setup dialog box.
Select parameter file 78F0756.prm
Specify the COM port for communication between host PC and this board.

Figure 4-3 Device Setup Dialog box

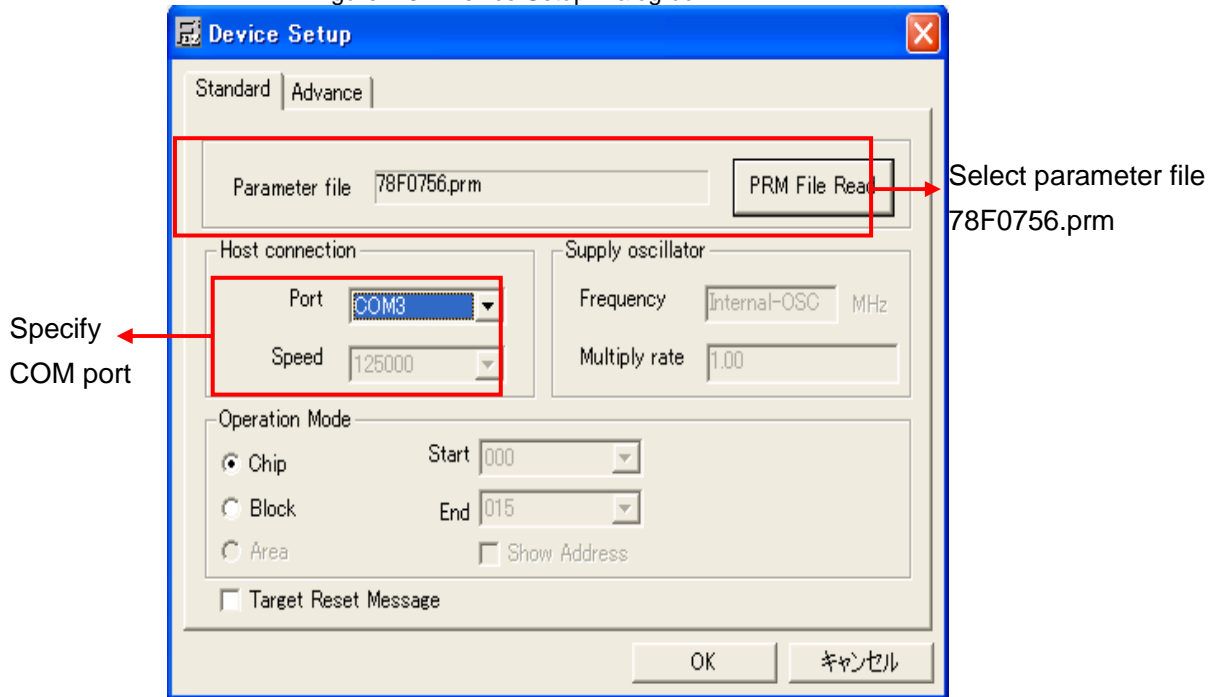

- ⑦ Click [Load] to select the hex file which is expected to be programmed.
- ⑧ Click [Autoprocedure] to do flash programming.
- ⑨ Close "WriteEZ3"
- ⑩ Disconnect the power supply and USB cable
- ⑪ Confirm bit 1, 7 and 8 of SW502 are set to "ON".
- ⑫ Provide DC 5V through CN9
- ⑬ Move slide switch VR601~VR603, the brightness of LED will change.
- ⑭ Disconnect the DC power from DC plug when finished evaluation.