

RTKA-TCSTKEV1Z

User's Manual: Evaluation Board

Industrial Analog and Power

All information contained in these materials, including products and product specifications, represents information on the product at the time of publication and is subject to change by Renesas Electronics Corp. without notice. Please review the latest information published by Renesas Electronics Corp. through various means, including the Renesas Electronics Corp. website (<http://www.renesas.com>).

RTKA-TCSTKEV1Z

Evaluation Board

The “DAQ on a Stick, Renesas Thermocouple” is one of a series of reference designs highlighting Renesas’ precision products. The reference design is a self contained demo showing a complete signal chain solution using Renesas precision parts and a Renesas microcontroller. The complete reference design is conveniently housed in a USB stick form factor. This compact design draws power through the USB port and uses a Graphical User Interface (GUI) to display the real time temperature. [Figure 1](#) shows the Data Acquisition on a Stick reference design.



Figure 1. DAQ on a Stick with Thermocouple

[Figure 2](#) shows a simplified schematic of the thermocouple design. The design uses Renesas’ ISL28134 chopper amplifier, ISL22317 precision Digitally Controlled Potentiometer (DCP), ISL21010 3.3V and 4.096V precision voltage references, the ISL26102 24-bit delta sigma converter, and Renesas R5F10JBC microcontroller.

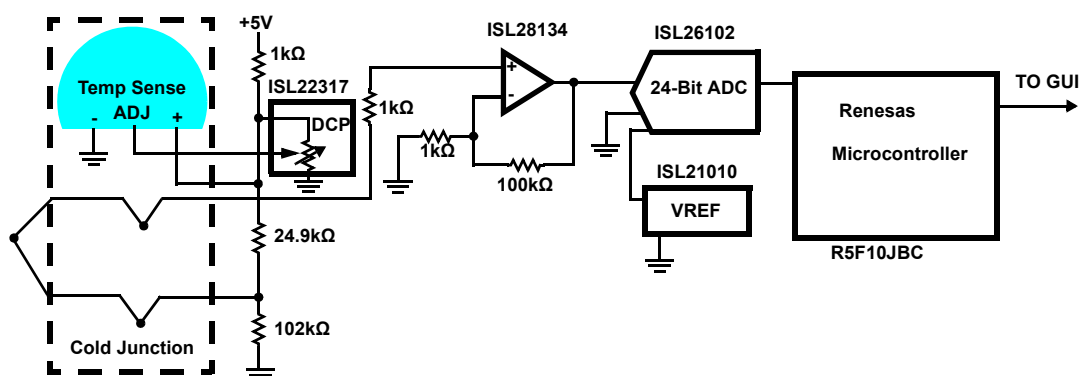

Figure 2. Simplified Thermocouple Schematic

Ordering Information

Part Number	Description
RTKA-TCSTKEV1Z	Evaluation Board

Related Literature

For a full list of related documents, visit our website:

- [ISL28134](#), [ISL21010](#), [ISL26102](#), [ISL22317](#), and [R5F10JBC](#) device pages

1. Getting Started

1.1 Installing the Graphical User Interface (GUI) Software and USB Drivers

The GUI Software and USB drivers have to be installed on a PC running Windows NT/2000/XP/Vista/Win7/Win 8/Win 10 operating system before connecting the RTKA-TCSTKEV1Z evaluation board to the USB port.

The software and a short video on the operation of this application demonstration can be downloaded or viewed from the Renesas [website](#).

1.2 Loading Software

1. Click the **Renesas DAQ on a Stick Software** link to load the executable.
2. Follow the on-screen instructions to complete the software installation. The installation program places the user interface software in the C:\Program Files\R12UZ0047_DAQ_V250 directory.
3. To create a shortcut on your desktop, check the **Create a Desktop Icon** box during the software installation.
4. Launch the application by checking the **Launch R12UZ0047_DAQ_V250** box, then click **Finish**.

1.3 Running the Evaluation Software

1. After software has been installed, connect the RTKA-TCSTKEV1Z board into a USB port on the computer.
2. Click on the Renesas DAQ shortcut (created in [Loading Software](#)) on the desktop. [Figure 3](#) shows the desktop icon. The green LED on the DAQ on a Stick board turns on.

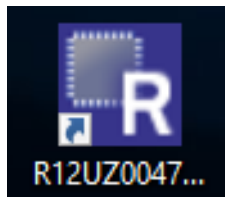

Figure 3. Desktop Icon

When the software starts, the DAQ Startup screen shown in [Figure 4 on page 4](#) appears. With the DAQ on a Stick connected, the USB Status indicator displays “Connected 0x2031”. The assigned HID code for this application is 0x2031, which verifies the software is communicating with the board.

If the DAQ on a Stick is not connected, or a problem exists with the demo, the message will read “HID Device Not Found”. If this occurs, click on the **Test USB Connection** button to enable the connection. If the connection is still not enabled, disconnect and reconnect the device, or restart the software.

2. Startup Screen

From the DAQ Startup Screen (Figure 4), click **Instantaneous Temperature** to get a single temperature reading or click **Start** to go to the Measurement Display screen shown in Figure 5. At this point, the green LED on the board turns off.

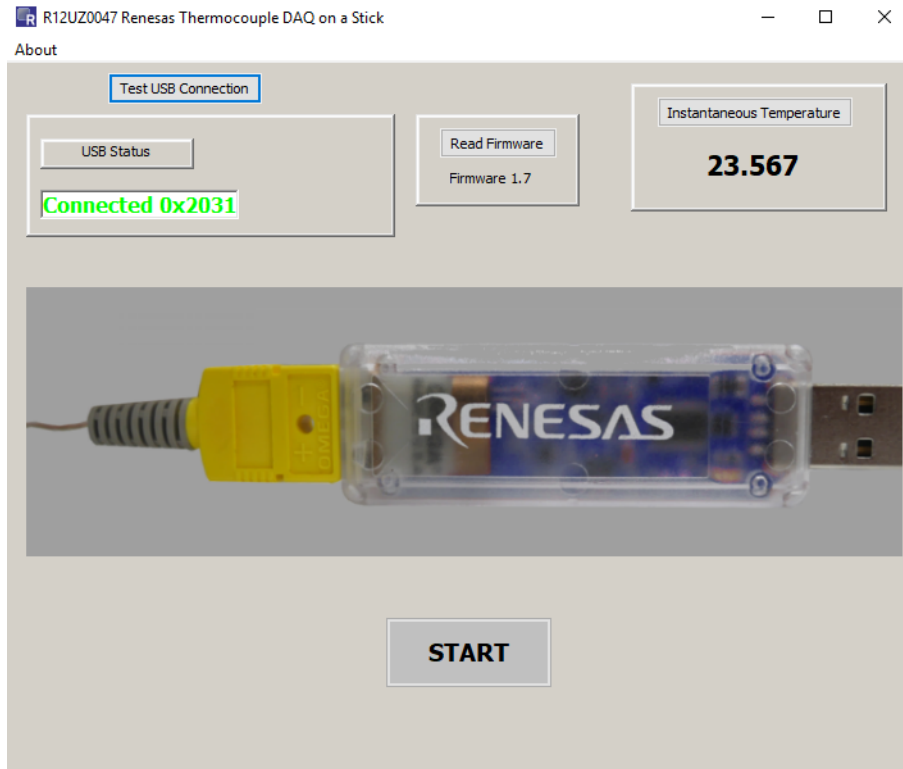

Figure 4. GUI Startup Screen

3. Measurement Display Screen

Click **Start** on the Startup Screen to go to the Measurement Display screen (Figure 5). From this screen you can do the following:

- Start and stop data collection
- Adjust the scaling of the X and Y axes (Automatic or Manual)
- Return to the startup screen by clicking on the **Show Main** button

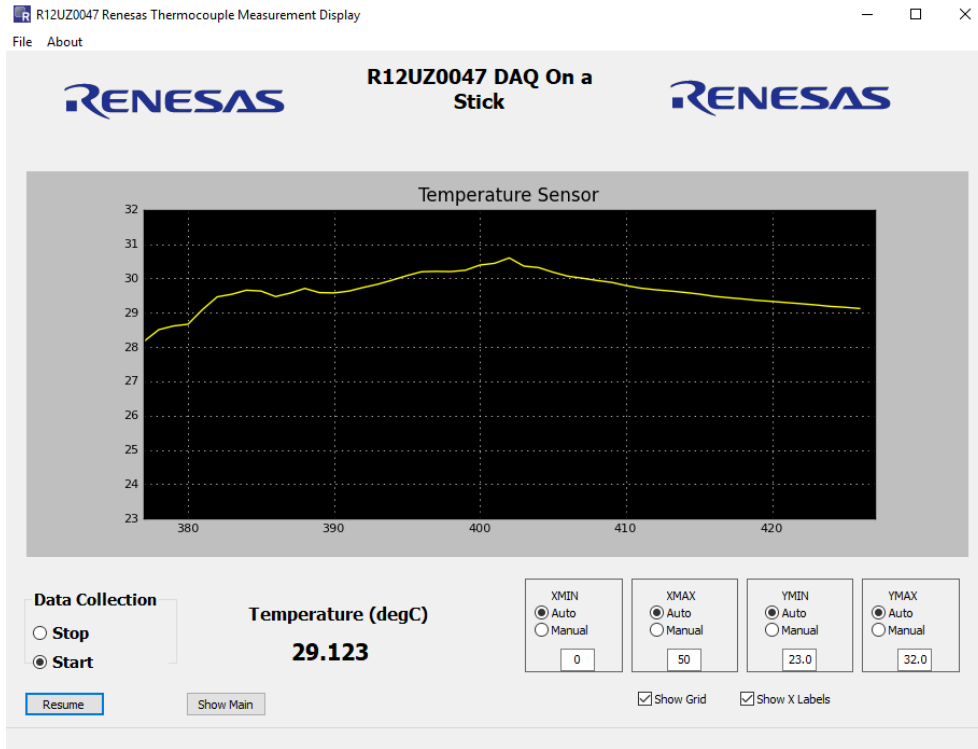

Figure 5. GUI Measurement Screen

3.1 Data Collection Radio Box

The Data Collection radio box is one of the most actively used controls.

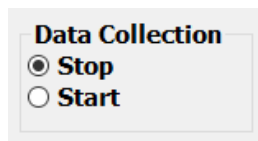

Figure 6. Data Collection Radio Box

- **Start** begins data collection and graphing in real time of the measured ADC values
- **Stop** halts data collection

3.2 Graphing X and Y Axis Control

The X and Y axis control windows enable control of the graph area horizontal (XMIN, XMAX) and vertical (YMIN, YMAX) axes.

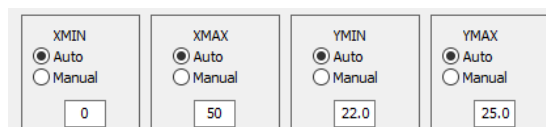

Figure 7. X and Y Axis Control

With **Auto** selected, the last 50 measurements are displayed as data collection runs, which produces a horizontal scrolling of the data.

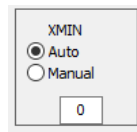

Figure 8. XMIN with Auto Selected

To see the history of the sensor reading from the beginning, pin the X axis to 0 by clicking **Manual** in the XMIN box and enter 0 in the selection window.

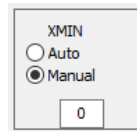

Figure 9. XMIN with Manual Selected

Typing in another value in the selection window jumps to that location.

The Y axis is automatically adjusted as data is collected. However, when graphing “flat line” waveforms, you can select **Manual** while data collection is running and zoom the Y axis in to see further detail.

During initialization, the controls are set to **Auto**. When started, you can select **Manual** and change the Y axis.

Note: The axis controls affect the graph display area only. During data export, all data collected, regardless of graph scaling, is sent to the .csv file.

3.3 Grid and X Labels Check Boxes

The **Show Grid** and **Show X Labels** boxes are graphing display options. Disable (deselect) **Show Grid** or **Show X Labels** to speed up real-time graphing display. These options can be enabled and disabled at any time.



Figure 10. Grid and X Labels Check Boxes

3.4 Show Main Button

The **Show Main** button re-displays the Startup screen.

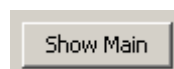

Figure 11. Show Main Button

If clicked more than once, the Startup form can be hidden behind the Measurement Form. You can move the forms so both can be viewed simultaneously.

3.5 Measurement Display Menu Options

The Measurement Display has a Menu bar at the top.



Figure 12. Measurement Display Menu Options

- **File** exports collected data to a .csv file and captures a picture of the graph display
- **About** shows the firmware version

These items are discussed in more detail in the following sections.

3.5.1 File

In the **File** menu, click **Save Chart** to save an image of the Graph, or click **Export Data** to export the collected data to a .csv file to import it into other applications.

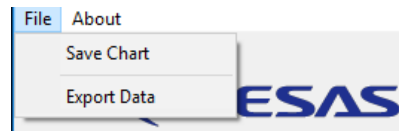

Figure 13. File Drop-Down Menu

3.5.2 About

The **About** menu provides information about the firmware version.



Figure 14. About Drop-Down Menu

4. Accuracy of Reference Design

The application circuit is calibrated at +25°C to within $\pm 0.1^\circ\text{C}$ using a Fluke 54II Thermometer. The application accuracy of this design is within the achievable accuracy of the K-type thermocouple for temperatures above 0°C.

[Table 1](#) shows the limits of error for the K-type thermocouple.

Table 1. Limits of Error for Thermocouple

Thermocouple Type	Temperature Range (°C)	Limits Of Error
K	0 to +1250	$\pm 2.2^\circ\text{C}$ or $\pm 0.75\%$
K	-200 to 0	$\pm 2.2^\circ\text{C}$ or $\pm 2.0\%$

[Table 2](#) shows the measured accuracy across -40°C to $+125^\circ\text{C}$.

Table 2. Measured Accuracy of DAQ on a Stick

Temperature Range (°C)	Measured Error (°C)
+25 to +125	0.7
0 to +125	0.7
-20 to +25	1.7
-40 to +25	3.5

5. Design Considerations

5.1 Temperature calculation

The temperature displayed on the GUI is calculated using the formula in Equation 1. V_{OUT} is the output voltage of the ISL28134 Chopper amplifier when set for a gain of 100.

$$(EQ. 1) \quad \text{Temperature} = \frac{(V_{OUT} - 1.1092)}{4.14\text{mV}/^{\circ}\text{C}}$$

5.2 ISL28134

The ISL28134 is an ideal choice for the input amplifier for a thermocouple design. The ISL28134 uses auto-correction circuitry to provide ultra low offset voltage (2.5 μ V), and low offset temperature drift (15nV/ $^{\circ}$ C). The very low 1/f noise corner <0.1Hz and low input noise voltage of the amplifier (8nV/ $\sqrt{\text{Hz}}$ at 100Hz) makes it ideal for low frequency precision applications requiring very high gain and low noise. Other key features of the ISL28134 are the wide gain bandwidth and rail-to-rail input/output swing.

5.3 ISL26102 24-bit ADC

The ISL26102 is a complete analog front-end with dual differential multiplexed inputs for high resolution measurements. The ISL26102 features a third order modulator providing up to 21.4-bit noise-free performance (10Sps). The 24-bit delta-sigma analog-to-digital converter includes a very low-noise amplifier with programmable gain. Although this application demo uses an input buffer amplifier (ISL28134), the high input impedance of the ISL26102 allows direct connection of sensors, such as load cell bridges to ensure the specified measurement accuracy without a buffer amplifier.

To initiate a correct power-up reset, diode D_1 , resistor R_3 and capacitor C_8 implement a simple RC delay to ensure the $\overline{\text{PDWN}}$ transitions from low-to-high after both power supplies have settled to specified levels.

5.4 ISL21010 (3.3V) Voltage Reference

The ISL21010CFH333 is a precision 3.3V, low dropout micropower band-gap voltage reference, which provides a $\pm 0.2\%$ accurate reference. The ISL21010 provides up to 25mA output current sourcing with low 150mV dropout voltage. The low supply current and low dropout voltage combined with high accuracy make the ISL21010 ideal for precision low powered applications.

5.5 ISL21010 (4.096V) Voltage Reference

The ISL21010CFH341 is a precision 4.096V, low dropout micropower band-gap voltage reference, which provides a $\pm 0.2\%$ accurate reference. The ISL21010 provides up to 25mA output current sourcing with low 150mV dropout voltage. The low supply current and low dropout voltage combined with high accuracy make the ISL21010 ideal for precision low powered applications.

5.6 ISL22317 DCP

The highly precise ISL22317 features a low end-to-end temperature coefficient of $\pm 10\text{ppm}/^{\circ}\text{C}$ and precise resistance selection. It maintains less than $\pm 1\%$ typical variance from the ideal resistance at each wiper position providing 99% accuracy of selected resistance value, which eliminates the need for complex algorithms to ensure precision. The ISL22317 operates from a single supply between 2.7V to 5.5V.

5.7 Bill of Materials

Part Number	Ref Des	Qty	Value	Tol.	Voltage (V)	Power	Package Type	Jedec Type	Mfr	Description
250R07C100JV4T	C1, C3	2	10pF	5%	25		402	CAP_0402RF	Johanson-Tech	C Series High-Q Chip Cap
GRM21BR71C475KA73L	C13	1	4.7µF	10%	16		805	CAP_0805	Murata	CERAMIC CAP
Generic	C9, C12, C15, C20	4	0.01µF	10%	16		402	CAP_0402	Various	Multilayer Cap
Generic	C5, C8, C10, C14, C16	5	0.1µF	10%	16		402	CAP_0402	Various	Multilayer Cap
Generic	C18, C19	2	OPEN	OPEN	OPEN		402	CAP_0402	Various	Multilayer Cap
Generic	C2, C7, C11, C22	4	1µF	20%	16		603	CAP_0603	Various	Ceramic Cap
Generic	C6	1	0.33µF	10%	25		603	CAP_0603	Various	Multilayer Cap
Generic	C17	1	2.2µF	10%	16		805	CAP_0805	Various	Multilayer Cap
Generic	C4	1	10µF	10%	16		1206	CAP_1206	Various	Multilayer Cap
597-3311-407	D1	1					SMD	DIA_LED1206	Dialight	Surface Mount Green LED
BAT54	D2	1					SINGLE	SOT23	Diodes	30V SCHOTTKY DIODE
MMSD4148T1	D3, D4	2					SOD123	SOD123	ON-Semi	Switching Diode
48037-1000	J1	1					MOLEX1	CON_USB_MOLEX_480371000	Molex	Right Angle USB A-Type Receptacle
PCC-SMP-K-100-R	J2	1					CON1	CON_PCC-SMP	Omega	Type K Thermocouple PCB Connector with Clip
251206102Y1	L1	1	1µH				SMD	SM1210	Fair-Rite	FERRITE BEAD
PAD_62	P1, P2	2	DNP				THOLE	PAD-62	Various	0.062 Pad with 0.041 Plated Thru Hole
Generic	R18	1	10k	0.10%		1/10W	805	RES_0805	Various	Metal Film Chip Resistor
Generic	R6, R9	2	0	0%		1/16W	402	RES_0402	Various	Thick Film Chip Resistor
Generic	R2, R3	2	100	1%		1/16W	402	RES_0402	Various	Thick Film Chip Resistor
Generic	R10, R12, R16, R19	4	1k	1%		1/16W	402	RES_0402	Various	Thick Film Chip Resistor
Generic	R1, R4, R11	3	10k	1%		1/16W	402	RES_0402	Various	Thick Film Chip Resistor
Generic	R15	1	100k	1%		1/16W	402	RES_0402	Various	Thick Film Chip Resistor
Generic	R13	1	102	1%		1/16W	402	RES_0402	Various	Thick Film Chip Resistor
Generic	R5	1	220	1%		1/16W	402	RES_0402	Various	Thick Film Chip Resistor

Part Number	Ref Des	Qty	Value	Tol.	Voltage (V)	Power	Package Type	Jedec Type	Mfr	Description
Generic	R14	1	24.9k	1%		1/16W	402	RES_0402	Various	Thick Film Chip Resistor
Generic	R7, R8, R20, R21	4	4.99k	1%		1/16W	402	RES_0402	Various	Thick Film Chip Resistor
MCR03EZPFX3001	R17	1	3k	1%		1/10W	603	RES_0603	Rohm	Metal Film Chip Resistor
ISL26102AVZ	U1	1					TSSOP	TSSOP24_173_256	Renesas	24 Pin 173 Mil TSSOP Package
ISL21010CFH341Z	U2	1					SOT	SOT23-3	Renesas	3 PIN SOT23-3 PACKAGE
IP4220CZ6	U3	1					SOT457	SOT457	NXP	Dual USB 2.0 Integrated ESD Protection
LM335Z	U4	1					TO92	TO92	National	PRECISION TEMPERATURE SENSOR
ISL28134FHZ	U5	1					SMD	SOT23-5	Renesas	5 Pin SOT23 Package
R5F10JBCANA	U6	1					QFN-S	QFN32_197X197_197_EPA	Renesas	32 LEAD QUAD FLAT PACKAGE (Pb-FREE)
ISL21010CFH333Z	U7	1					SOT	SOT23-3	Renesas	3 PIN SOT23-3 PACKAGE
ISL22317WFRTZ	U8	1					DFN3X3B	TDFN10_118X118_197_EPB	Renesas	10 Lead 3 X 3 0.5 Pitch Thin Dual Flat Package with E-Pad
NX5032GA-12.000M-LN-CD-1	Y1	1					SM	XTAL_NX5032GA	NDK	12.000MHz SM Crystal

5.8 RTKA-TCSTKEV1Z Evaluation Board Layout

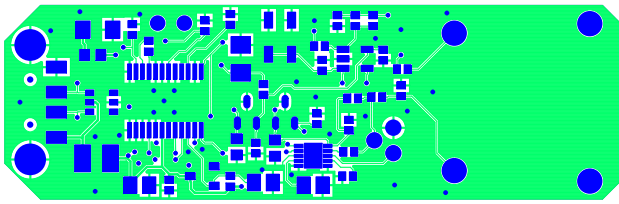

Figure 15. Top Layer

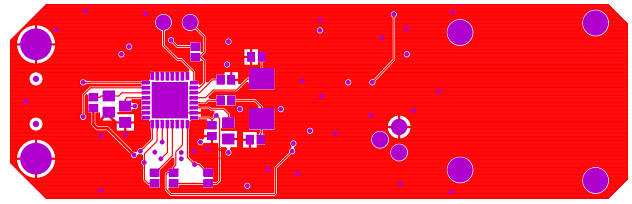

Figure 16. Bottom Layer

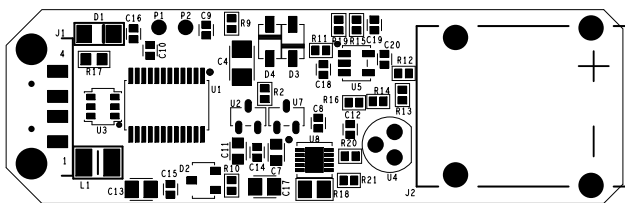

Figure 17. Top Assembly Drawing

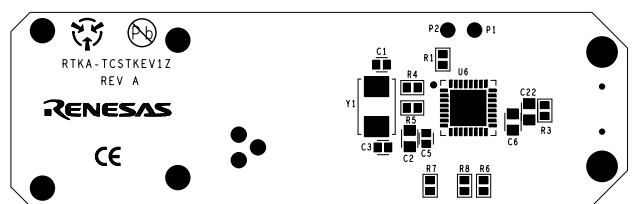

Figure 18. Bottom Assembly Drawing

6. Revision History

Rev.	Date	Description
1.01	Jun.5.19	Updated ISL21010 information.
1.00	Apr.5.19	Initial release

Notice

1. Descriptions of circuits, software and other related information in this document are provided only to illustrate the operation of semiconductor products and application examples. You are fully responsible for the incorporation or any other use of the circuits, software, and information in the design of your product or system. Renesas Electronics disclaims any and all liability for any losses and damages incurred by you or third parties arising from the use of these circuits, software, or information.
2. Renesas Electronics hereby expressly disclaims any warranties against and liability for infringement or any other claims involving patents, copyrights, or other intellectual property rights of third parties, by or arising from the use of Renesas Electronics products or technical information described in this document, including but not limited to, the product data, drawings, charts, programs, algorithms, and application examples.
3. No license, express, implied or otherwise, is granted hereby under any patents, copyrights or other intellectual property rights of Renesas Electronics or others.
4. You shall not alter, modify, copy, or reverse engineer any Renesas Electronics product, whether in whole or in part. Renesas Electronics disclaims any and all liability for any losses or damages incurred by you or third parties arising from such alteration, modification, copying or reverse engineering.
5. Renesas Electronics products are classified according to the following two quality grades: "Standard" and "High Quality". The intended applications for each Renesas Electronics product depends on the product's quality grade, as indicated below.
 - "Standard": Computers; office equipment; communications equipment; test and measurement equipment; audio and visual equipment; home electronic appliances; machine tools; personal electronic equipment; industrial robots; etc.
 - "High Quality": Transportation equipment (automobiles, trains, ships, etc.); traffic control (traffic lights); large-scale communication equipment; key financial terminal systems; safety control equipment; etc.Unless expressly designated as a high reliability product or a product for harsh environments in a Renesas Electronics data sheet or other Renesas Electronics document, Renesas Electronics products are not intended or authorized for use in products or systems that may pose a direct threat to human life or bodily injury (artificial life support devices or systems; surgical implantations; etc.), or may cause serious property damage (space system; undersea repeaters; nuclear power control systems; aircraft control systems; key plant systems; military equipment; etc.). Renesas Electronics disclaims any and all liability for any damages or losses incurred by you or any third parties arising from the use of any Renesas Electronics product that is inconsistent with any Renesas Electronics data sheet, user's manual or other Renesas Electronics document.
6. When using Renesas Electronics products, refer to the latest product information (data sheets, user's manuals, application notes, "General Notes for Handling and Using Semiconductor Devices" in the reliability handbook, etc.), and ensure that usage conditions are within the ranges specified by Renesas Electronics with respect to maximum ratings, operating power supply voltage range, heat dissipation characteristics, installation, etc. Renesas Electronics disclaims any and all liability for any malfunctions, failure or accident arising out of the use of Renesas Electronics products outside of such specified ranges.
7. Although Renesas Electronics endeavors to improve the quality and reliability of Renesas Electronics products, semiconductor products have specific characteristics, such as the occurrence of failure at a certain rate and malfunctions under certain use conditions. Unless designated as a high reliability product or a product for harsh environments in a Renesas Electronics data sheet or other Renesas Electronics document, Renesas Electronics products are not subject to radiation resistance design. You are responsible for implementing safety measures to guard against the possibility of bodily injury, injury or damage caused by fire, and/or danger to the public in the event of a failure or malfunction of Renesas Electronics products, such as safety design for hardware and software, including but not limited to redundancy, fire control and malfunction prevention, appropriate treatment for aging degradation or any other appropriate measures. Because the evaluation of microcomputer software alone is very difficult and impractical, you are responsible for evaluating the safety of the final products or systems manufactured by you.
8. Please contact a Renesas Electronics sales office for details as to environmental matters such as the environmental compatibility of each Renesas Electronics product. You are responsible for carefully and sufficiently investigating applicable laws and regulations that regulate the inclusion or use of controlled substances, including without limitation, the EU RoHS Directive, and using Renesas Electronics products in compliance with all these applicable laws and regulations. Renesas Electronics disclaims any and all liability for damages or losses occurring as a result of your noncompliance with applicable laws and regulations.
9. Renesas Electronics products and technologies shall not be used for or incorporated into any products or systems whose manufacture, use, or sale is prohibited under any applicable domestic or foreign laws or regulations. You shall comply with any applicable export control laws and regulations promulgated and administered by the governments of any countries asserting jurisdiction over the parties or transactions.
10. It is the responsibility of the buyer or distributor of Renesas Electronics products, or any other party who distributes, disposes of, or otherwise sells or transfers the product to a third party, to notify such third party in advance of the contents and conditions set forth in this document.
11. This document shall not be reprinted, reproduced or duplicated in any form, in whole or in part, without prior written consent of Renesas Electronics.
12. Please contact a Renesas Electronics sales office if you have any questions regarding the information contained in this document or Renesas Electronics products.

(Note1) "Renesas Electronics" as used in this document means Renesas Electronics Corporation and also includes its directly or indirectly controlled subsidiaries.

(Note2) "Renesas Electronics product(s)" means any product developed or manufactured by or for Renesas Electronics.

(Rev.4.0-1 November 2017)

Corporate Headquarters

TOYOSU FORESIA, 3-2-24 Toyosu,
Koto-ku, Tokyo 135-0061, Japan
www.renesas.com

Trademarks

Renesas and the Renesas logo are trademarks of Renesas Electronics Corporation. All trademarks and registered trademarks are the property of their respective owners.

Contact Information

For further information on a product, technology, the most up-to-date version of a document, or your nearest sales office, please visit:
www.renesas.com/contact/

RTKA-TCSTKEV1Z