

ISL8205MEVAL1Z

Evaluation Board User Guide

UG072
Rev 0.00
May 3, 2016

The [ISL8205M](#) power module is a single channel synchronous step-down complete power supply, capable of delivering up to 5A of continuous current. Operating from a single 2.6V to 5.5V input power rail and integrating a controller, power inductor and MOSFETs, ISL8205M can achieve up to 95% conversion efficiency. It also provides fast transient response with excellent loop stability as well as deliver output voltage as low as 0.6V. Switching frequency is also adjustable from 680kHz to 3.5MHz with either external resistor or SYNC clock option. Selectable PFM mode can also be enabled to boost up light load efficiency to extend battery life. Other features include programmable soft-start, soft-stop, input undervoltage lockout, 100% duty cycle operation, over-temperature, overcurrent/short-circuit with hiccup mode, overvoltage and negative overcurrent protection. It also has a dedicated enable pin and power-good flag that allow for easy system power rails sequencing.

The ISL8205MEVAL1Z evaluation board is designed to demonstrate the performance of the ISL8205M. The board is by default set to be 1.2V output voltage with 1.6MHz switching frequency. Other output voltage values can be easily set by changing the jumper position. Switching frequency can be adjusted by changing the FS pin resistor.

References

- [ISL8205M](#) datasheet

Features

- 2.6V to 5.5V input voltage range
- Adjustable output voltage as low as 0.6V with $\pm 1.6\%$ accuracy over line/load/temperature
- Default 1.8MHz current mode control operations
 - 680kHz to 3.5MHz resistor adjustable
 - External synchronization up to 3.5MHz
 - Selectable light-load efficiency mode
 - 100% duty cycle LDO mode
- Programmable soft-start and soft-stop output discharge
- Dedicated enable pin and power-good flag
- UVLO, over-temperature, overcurrent, overvoltage and negative overcurrent protections

Specifications/Default Set-Up

- $V_{IN} = 2.6V$ to $5.5V$
- V_{OUT} options (via jumper selection): 1V, 1.2V, 2.5V, 3.3V
- MAX I_{OUT} up to 5A
- $f_{SW} = 1.6MHz$ by default
- Set to PWM mode by default
- 1ms soft-start time by default

Ordering Information

PART NUMBER	DESCRIPTION
ISL8205MEVAL1Z	ISL8205M single 5A power module evaluation board

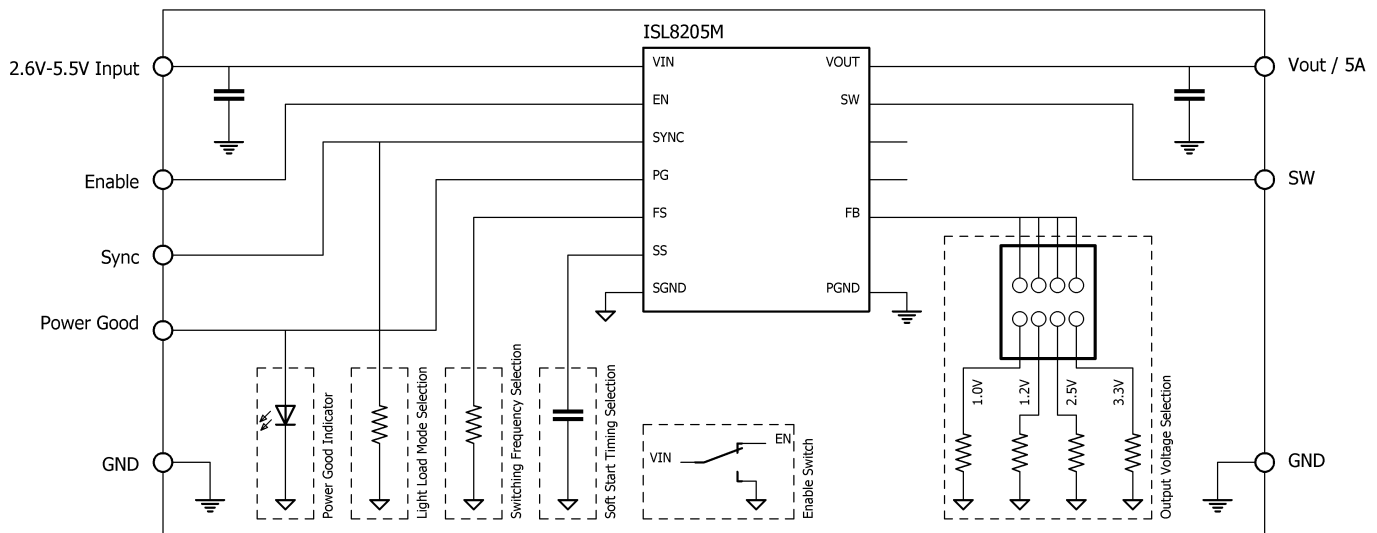

FIGURE 1. ISL8205MEVAL1Z BLOCK DIAGRAM

TABLE 1. ISL8205M COMPONENT SELECTION GUIDE MATRIX

V_{IN} (V)	V_{OUT} (V)	f_{SW} (MHz)	C_{IN} (μ F)	C_{OUT} (μ F)	R_7 (k Ω)	R_{SET} (k Ω)	C_{FF} (pF)
5	0.6	0.8	2x22	1x100	261	OPEN	390
5	0.9	1.2	2x22	3x22	169	200	560
5	1	1.3	2x22	3x22	154	150	560
5	1	1.3	2x22	2x22	154	150	820
5	1.2	1.6	2x22	2x22	124	100	820
5	1.5	1.7	2x22	2x22	115	66.5	560
5	1.8	2	2x22	2x22	95.3	49.9	470
5	2.5	2.5	2x22	2x22	75	31.6	330
5	3.3	3	2x22	2x22	59	22.1	330
3.3	0.6	0.8	2x22	1x100	261	OPEN	390
3.3	0.9	1.2	2x22	3x22	169	200	560
3.3	1	1.3	2x22	3x22	154	150	560
3.3	1	1.3	2x22	2x22	154	150	820
3.3	1.2	1.6	2x22	2x22	124	100	820
3.3	1.5	1.7	2x22	2x22	115	66.5	560
3.3	1.8	2	2x22	2x22	95.3	49.9	470
3.3	2.5	2.5	2x22	2x22	75	31.6	330



FIGURE 2. TOP OF BOARD



FIGURE 3. BOTTOM OF BOARD

Recommended Equipment

- 0V to 5.5V power supply with at least 7A source current capability
- Electronic load capable of sinking current up to 5A
- Digital Multimeters (DMMs)
- 100MHz quad-trace oscilloscope

Functional Description

The ISL8205M is a single 5A step-down high efficiency power module optimized for FPGA, DSP and Li-ion battery power devices. The module switches at 1.8MHz by default when the FS pin is shorted to VIN. The switching frequency is also adjustable from 680kHz to 3.5MHz through a resistor from FS to SGND. To

boost light-load efficiency, ISL8205M can also be configured to operate in PFM mode by pulling the SYNC pin to SGND. Peak current mode control scheme is implemented for fast transient response. The module utilizes internal compensation to stabilize the system and optimize transient response, which greatly simplifies the application. Other excellent features include external synchronization, 100% duty cycle operation and very low quiescent current. For further information, please refer to the [ISL8205M](#) datasheet.

Quick Start

The ISL8205MEVAL1Z is set to be $V_{OUT} = 1.2V$, $f_{SW} = 1.6MHz$ by default. For other V_{OUT} options, the recommended f_{SW} needs to be adjusted by changing resistor (R_7) connected to the FS pin.

Please refer to [Table 1](#) for more information. The following operation procedure will be based on default setting.

1. Before applying power to input, ensure one shorting jumper on J1 across pins 5 and 6 is present. This selects $V_{OUT} = 1.2V$ option.
2. Set the ENABLE switches SW1 to the “OFF” position.
3. Connect the positive of a power supply to the VIN connector and the negative of the power supply to the PGND connector. Make sure the power supply is not enabled when making connections and the input power supply voltage is set to a value between 2.6V and 5.5V.
4. Turn the power supply on.
5. Turn ENABLE switch SW1 to the “ON” position to enable module operation.
6. The power-good LED should illuminate in green if the module is operating properly.
7. Measure output voltage, V_{OUT} , at test points VOUT and PGND. Module output should be 1.2V.

Programming the Output Voltage

The ISL8205MEVAL1Z evaluation board has several preset output voltages, 1.0V, 1.2V, 2.5V and 3.3V, which can be selected in J1 jumper. Other V_{OUT} values other than on-board options can be set by proper selection of the resistor (R_{SET}) connecting from FB to SGND. In this case, R_{SET} for default options (R_9 , R_{10} , R_{11} , R_{12}) may need to be changed. The output voltage is governed by [Equation 1](#).

$$V_{OUT} = V_{REF} \cdot \frac{R_{SET} + 100k\Omega}{R_{SET}} \quad (\text{EQ. 1})$$

For most popular V_{OUT} values and corresponding R_{SET} values, please refer to [Table 1](#) for more information.

Feed-Forward Capacitor Selection

In typical applications where the output capacitors are all ceramic, a feed-forward capacitor, C_{FF} (as annotated as C_{12} , C_{13} , C_{14} , C_{15} in schematic) is needed to be put in parallel with each R_{SET} to insure loop stability in extreme operating conditions. With internal compensation mode enabled, the C_{FF} values for typical operating conditions are optimized and listed in [Table 1](#). And that's how C_{12} , C_{13} , C_{14} , C_{15} default values are selected. Please note that, for system parameters that are different from [Table 1](#) or external instead of internal compensation is used, the optimized value of C_{FF} needs to be adjusted.

Frequency Adjust

The switching frequency of ISL8205M is adjustable ranging from 680kHz to 3.5MHz via a simple resistor R_{FS} (as shown in R_7 on ISL8205MEVAL1Z board) across FS to SGND. The switching frequency setting is based on [Equation 2](#):

$$R_{FS}[k\Omega] = \frac{220 \cdot 10^3}{f_{OSC}[kHz]} - 14 \quad (\text{EQ. 2})$$

When the FS pin is directly tied to VIN, the frequency of operation is fixed at 1.8MHz. For a recommended switching frequency with typical operation conditions, refer to [Table 1](#). More detailed

information on recommended switching frequency and f_{SW} selection range is provided in [“Recommended Switching Frequency”](#) and [“Operation Range”](#).

Recommended Switching Frequency

Selection of switching frequency for each V_{IN} and V_{OUT} combination needs to take into account a few trade-offs. Generally, lower switching frequency will lead to higher efficiency. However, switching frequency should not be decreased too low due to negative current protection limit. Moreover, when output voltage is relatively high, low switching frequency will result in more sub-harmonic oscillation. Therefore, operating frequency needs to be kept relatively high under high V_{OUT} conditions. However, again, switching frequency cannot be increased too much. Otherwise, the minimum on-time limit could be violated. Based on these considerations, [Figure 4](#) provides the recommended switching frequency under various typical V_{IN} and across V_{OUT} ranges.

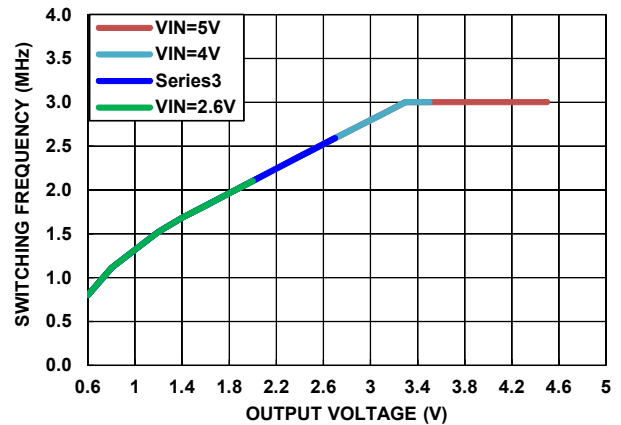

FIGURE 4. SWITCHING FREQUENCY RECOMMENDATION

Operation Range

By default, the ISL8205MEVAL1Z is configured to be operating at $V_{OUT} = 1.2V$ (J1 jumper position is at pins 5 and 6), $f_{SW} = 1.6MHz$ conditions. V_{IN} ranges from 2.6V to 5.5V. The board can also support a wider operating range to meet the requirement of specific applications. The V_{OUT} can be adjusted from 0.6V to 5V. Load current range is from 0A to 5A. Note that, for continuous operation at 5A, airflow across the board may be needed. The f_{SW} can also be tuned. However, to ensure sufficient stability margins, switching frequency can only be adjusted within the safe operating regions represented with [Figures 5](#) through [9](#). Operating outside of these areas may lead to system instability.

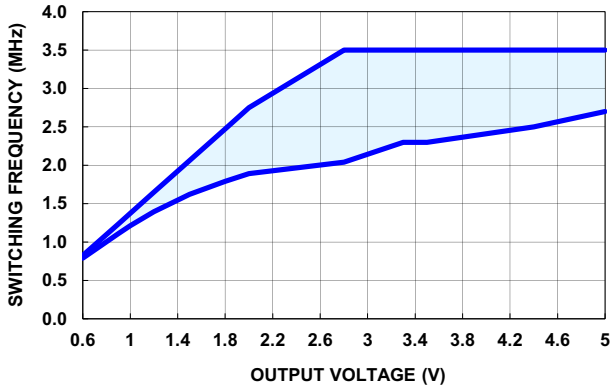

FIGURE 5. OPERATION REGION $V_{IN} = 5.5V$

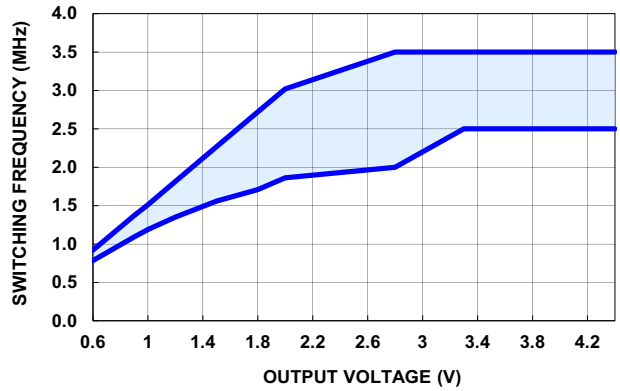

FIGURE 6. OPERATION REGION $V_{IN} = 5.0V$

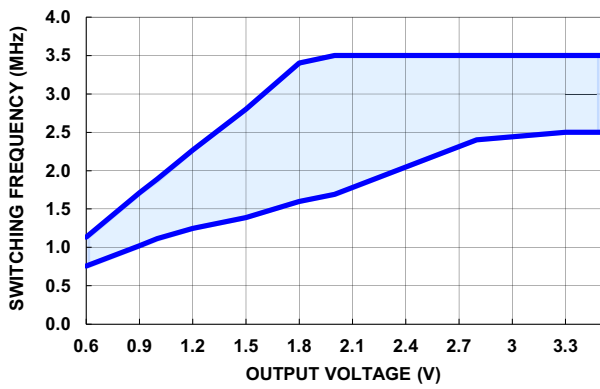

FIGURE 7. OPERATION REGION $V_{IN} = 4.0V$

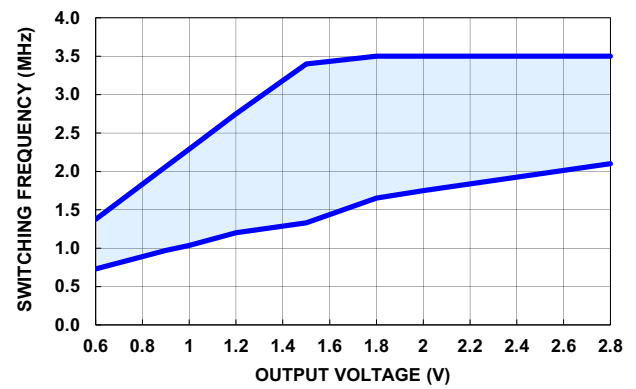

FIGURE 8. OPERATION REGION $V_{IN} = 3.3V$

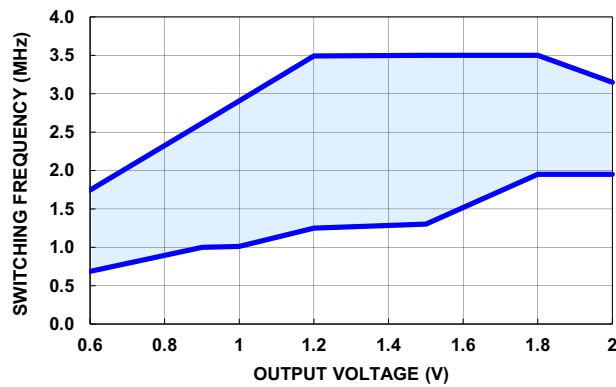

FIGURE 9. OPERATION REGION $V_{IN} = 2.6V$

PWM/PFM Selection

By default, ISL8205MEVAL1Z is set to operate in PWM mode. This is achieved by connecting SYNC to VIN through R₁. Pulling the SYNC pin LOW, forces the module into PFM mode, which enables pulse-skipping at light load to minimize the switching loss by reducing the switching frequency. Refer to [ISL8205M](#) datasheet for more detailed information. For ISL8205MEVAL1Z, PFM mode can be enabled by removing R₁ and shorting SYNC to SGND by putting a 0Ω resistor on R₂.

Soft Start-Up

The soft start-up reduces the inrush current during the start-up. For ISL8205MEVAL1Z, the soft start-up time is set to 1ms by default through C₆. However, start-up time can be adjusted by tuning the C₆ value. [Equation 3](#) can be used to determine the C₆ value for the target soft-start time t_{SS}.

$$C_6[\mu\text{F}] = 3.1 \times t_{\text{SS}}[\text{S}] \quad (\text{EQ. 3})$$

Evaluation Board Information

The ISL8205MEVAL1Z evaluation board is a 2x2in² four-layer FR-4 board with 2oz. copper on all the layers. The board can be used as a single 5A reference design. Refer to [Figures 11](#) through [14](#) for board layout information. The board is designed with mechanical switches for ENABLE, power-good LED indicators, several connectors, test points and jumpers, which make testing the board easy.

Thermal Considerations and Current Derating

Board layout is very critical in order to make the module operate safely and deliver maximum allowable power. In order for the board to operate properly in the high ambient temperature environments and carry full load currents, the board layout needs to be carefully designed to maximize thermal performance. To achieve this, select enough trace width, copper weight and proper connectors.

The ISL8205MEVAL1Z evaluation board is capable of operating at 5A full load current at room temperature with plenty of safety margin for junction temperature. However, if the board is to operate at elevated ambient temperatures, then the available output current may need to be derated. Refer to the derated current curves in the [ISL8205M](#) datasheet to determine the maximum output current the evaluation board can supply.

ISL8205MEVAL1Z Schematic

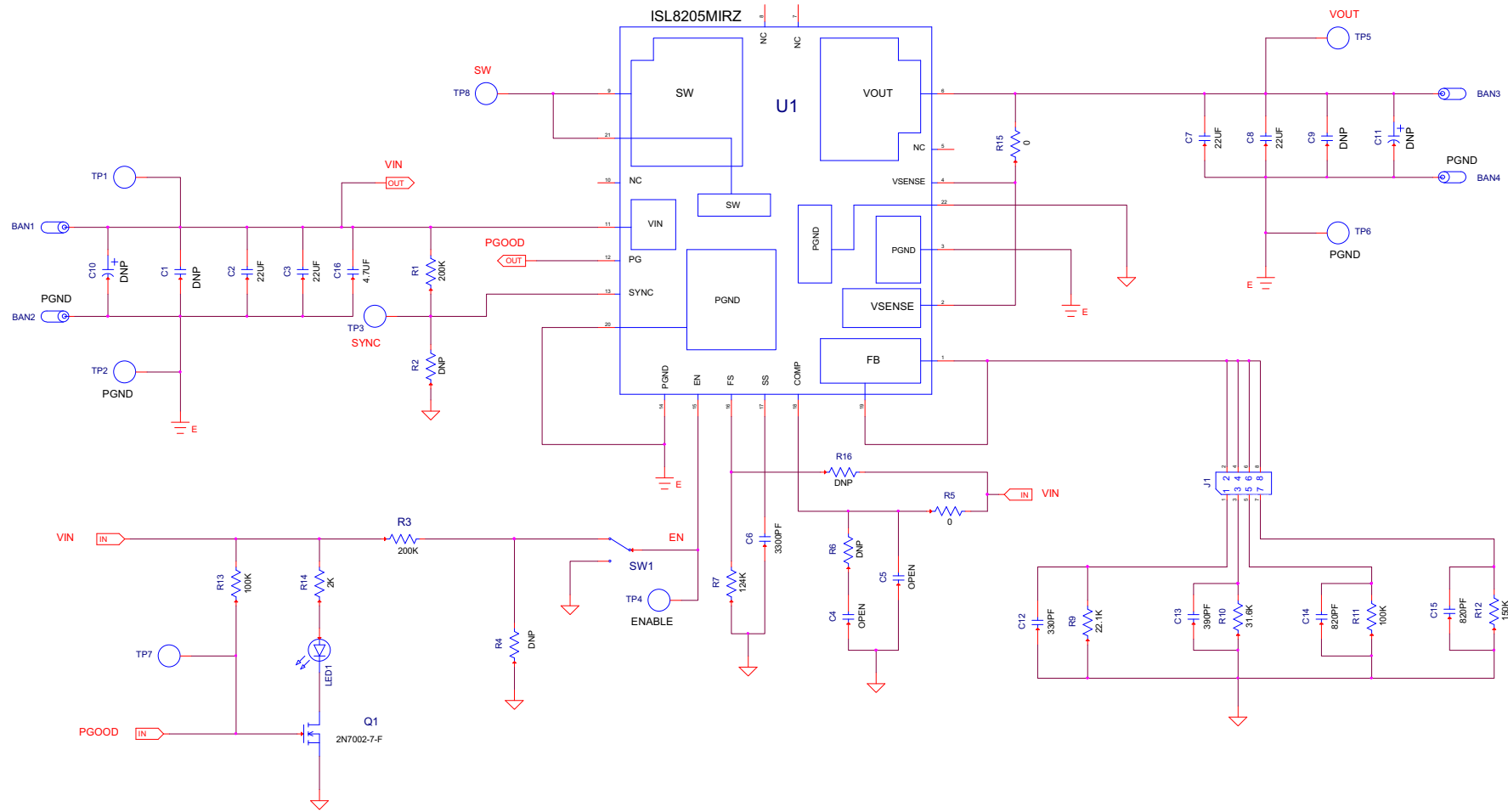

FIGURE 10. SCHEMATIC

Bill of Materials

REFERENCE DESIGNATOR	QTY	MANUFACTURER	PART NUMBER	DESCRIPTION
C16	1	MURATA	GRM21BR71A475KA73L	CAP, SMD, 0805, 4.7µF, 10V, 10%, X7R, ROHS
C12	1	TDK	CGA2B2C0G1H331J050BA	CAP, SMD, 0402, 330pF, 50V, 5%, NPO, ROHS
C6	1	PANASONIC	ECU-E1E332KBQ	CAP, SMD, 0402, 3300pF, 25V, 10%, X7R, ROHS
C13	1	YAGEO	CC0402JRNPO9BN391	CAP, SMD, 0402, 390pF, 50V, 5%, NPO, ROHS
C14, C15	2	SAMSUNG	CL05C821JB5NNNC	CAP, SMD, 0402, 820pF, 50V, 5%, NPO, ROHS
C4, C5	0			CAP, SMD, 0402, DNP-PLACE HOLDER, ROHS
C2, C3, C7, C8	4	TAIYO YUDEN	LMK316AB7226KL-TR	CAP, SMD, 1206, 22µF, 10V, 10%, X7R, ROHS
C1, C9	0			CAP, SMD, 1206, DNP-PLACE HOLDER, ROHS
TP1-TP8	8	KEYSTONE	5002	CONN-MINI TEST POINT, VERTICAL, WHITE, ROHS
BAN1-BAN4	4	KEYSTONE	575-4	CONN-JACK, MINI BANANA, 0.175 PLUG, NICKEL/BRASS, ROHS
J1	1	BERG/FCI	68000-236HLF	CONN-HEADER, 1x8, BRKAWY 1x36, 2.54mm, ROHS
J1-Pins 5-6	1	SULLINS	SPC02SYAN	CONN-JUMPER, SHORTING, 2PIN, BLACK, GOLD, ROHS
LED1	1	LITEON/VISHAY	LTST-C190KGKT	LED, SMD, 0603, GREEN CLEAR, 2V, 20mA, 571nm, 35mcd, ROHS
U1	1	INTERSIL	ISL8205MIRZ	IC-5A PWR MODULE, ANALOG DC/DC, 22P, QFN, 4.5x7.5, ROHS
Q1	1	DIODES, INC.	2N7002-7-F	TRANSISTOR, N-CHANNEL, 3LD, SOT-23, 60V, 115mA, ROHS
R12	1	TE CONNECTIVITY	3-1879216-2	RES, SMD, 0402, 150k, 1/16W, 0.1%, TF, ROHS
R9	1	TE CONNECTIVITY	6-1879215-6	RES, SMD, 0402, 22.1k, 1/16W, 0.1%, TF, ROHS
R11	1	TE CONNECTIVITY	9-1879208-7	RES, SMD, 0402, 100k, 1/16W, 0.1%, TF, ROHS
R4	0			RES, SMD, 0603, 0.1%, MF, DNP-PLACE HOLDER
R5, R15	2	VENKEL	CR0402-16W-00T	RES, SMD, 0402, 0Ω, 1/16W, 5%, TF, ROHS
R1	1	ROHM	MCR01MZPF2003	RES, SMD, 0402, 200k, 1/16W, 1%, TF, ROHS
R2, R6, R16	0			RES, SMD, 0402, DNP, DNP, DNP, TF, ROHS
R13	1	VENKEL	CR0603-10W-1003FT	RES, SMD, 0603, 100k, 1/10W, 1%, TF, ROHS
R14	1	KOA	RK73H1JTTD2001F	RES, SMD, 0603, 2k, 1/10W, 1%, TF, ROHS
R3	1	VENKEL	CR0603-10W-2003FT	RES, SMD, 0603, 200k, 1/10W, 1%, TF, ROHS
R7	1	STACKPOLE	RNCF0402DTE124K	RES, SMD, 0402, 124k, 1/16W, 0.5%, TF, ROHS
R10	1	YAGEO	RT0402BRD0731K6L	RES, SMD, 0402, 31.6k, 1/16W, 0.1%, TF, ROHS
SW1	1	ITT INDUSTRIES/C&K DIVISION	GT11MSCBE	SWITCH-TOGGLE, SMD, 6PIN, SPDT, 2POS, ON-NONE-ON, ROHS
C10	0			CAP, TANT, SMD, 2917, 10V, DNP-PLACE HOLDER
C11	0			CAP, TANT POLY, SMD, 2917, 10V, DNP-PLACE HOLDER

Board Layout

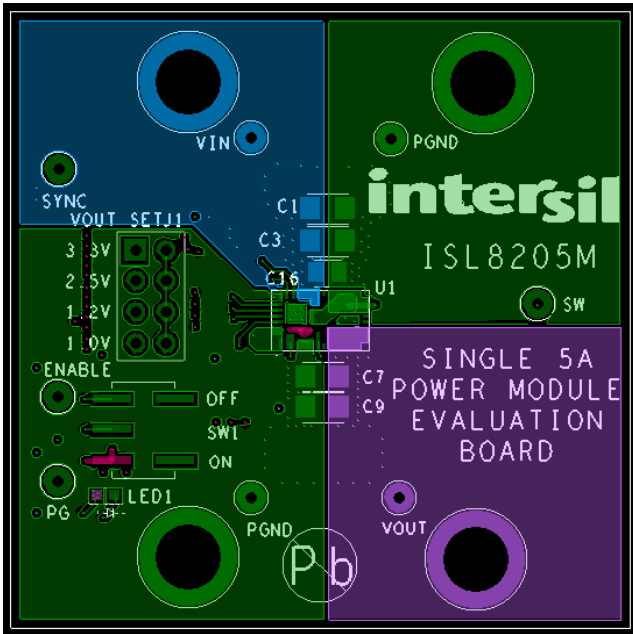

FIGURE 11. TOP LAYER (TOP VIEW)

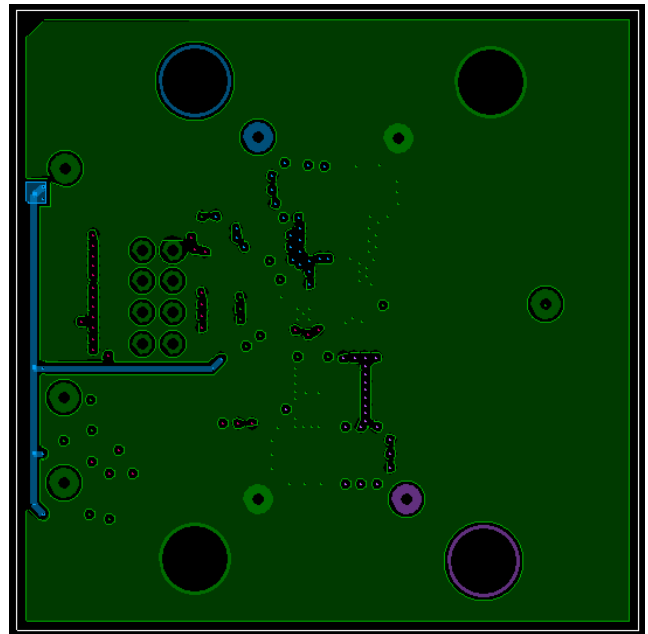

FIGURE 12. INNER LAYER 1 (TOP VIEW)

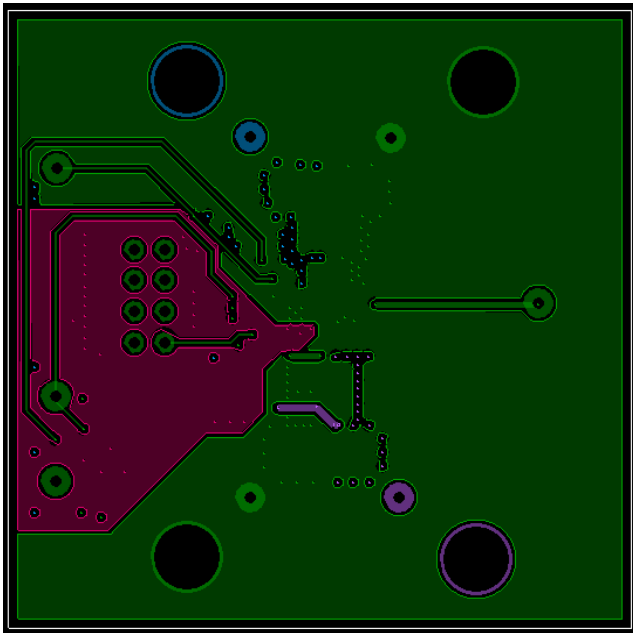

FIGURE 13. INNER LAYER 2 (TOP VIEW)

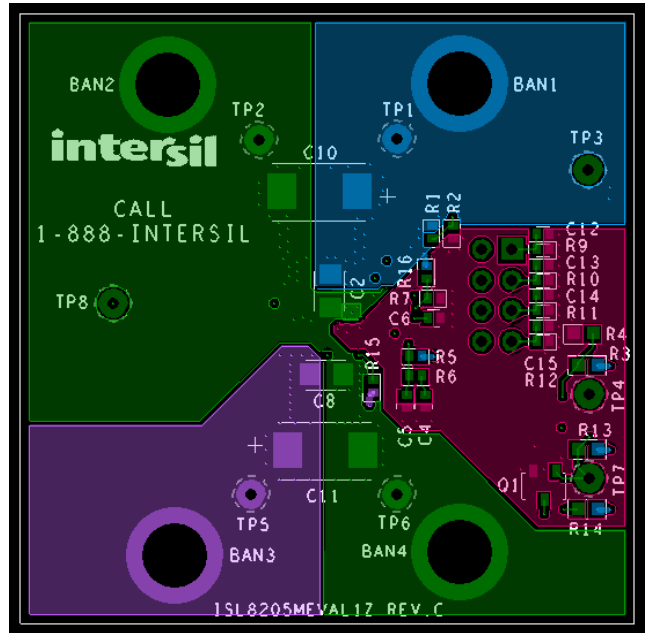

FIGURE 14. BOTTOM LAYER (BOTTOM VIEW)

ISL8205MEVAL1Z Performance Data

board at +25°C ambient and free air OLFM.

The following data was acquired using a ISL8205MEVAL1Z evaluation

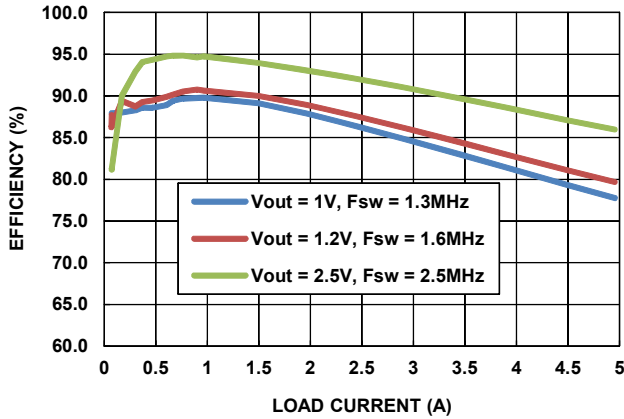

FIGURE 15. EFFICIENCY $T_A = +25^\circ\text{C}$, $V_{IN} = 3.3\text{V}$ PFM MODE

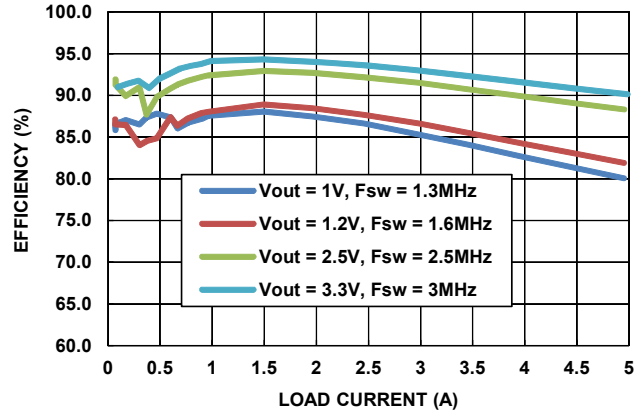

FIGURE 16. EFFICIENCY $T_A = +25^\circ\text{C}$, $V_{IN} = 5\text{V}$ PFM MODE

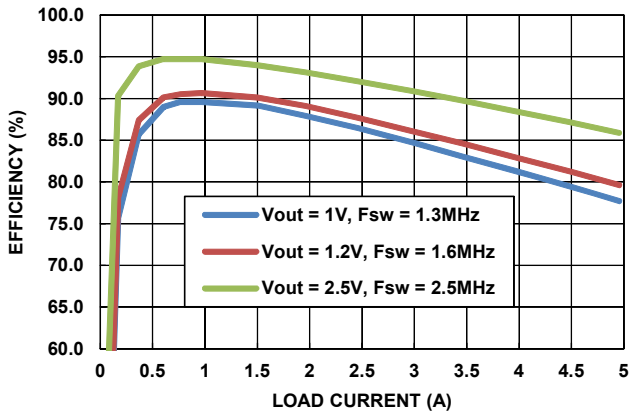

FIGURE 17. EFFICIENCY $T_A = +25^\circ\text{C}$, $V_{IN} = 3.3\text{V}$ PWM MODE

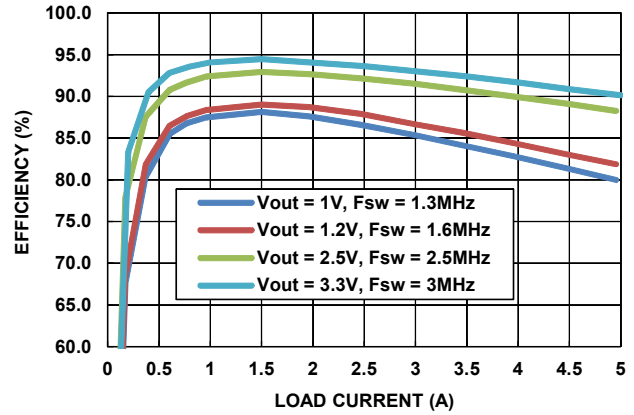

FIGURE 18. EFFICIENCY $T_A = +25^\circ\text{C}$, $V_{IN} = 5\text{V}$ PWM MODE

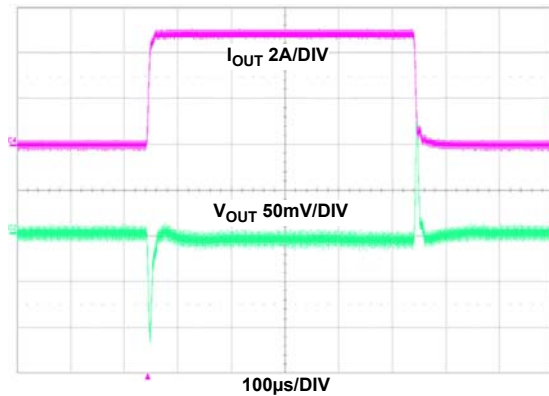

FIGURE 19. LOAD TRANSIENT $V_{IN} = 5\text{V}$, $V_{OUT} = 1.2\text{V}$, $I_{OUT} = 0$ TO 5A , $f_{SW} = 1.6\text{MHz}$, $C_{OUT} = 2 \times 22\mu\text{F}$ CERAMIC CAPACITORS, LOAD CURRENT SLEW RATE: $1\text{A}/\mu\text{s}$

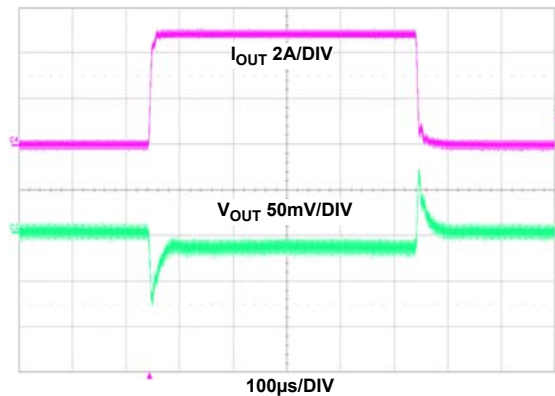

FIGURE 20. LOAD TRANSIENT $V_{IN} = 5\text{V}$, $V_{OUT} = 3.3\text{V}$, $I_{OUT} = 0$ TO 5A , $f_{SW} = 3\text{MHz}$, $C_{OUT} = 2 \times 22\mu\text{F}$ CERAMIC CAPACITORS, LOAD CURRENT SLEW RATE: $1\text{A}/\mu\text{s}$

ISL8205MEVAL1Z Performance Data The following data was acquired using a ISL8205MEVAL1Z evaluation board at +25°C ambient and free air OLFM. (Continued)



FIGURE 21. THERMAL IMAGE AT $V_{IN} = 5V$, $V_{OUT} = 1.2V$, $I_{OUT} = 5A$, $f_{SW} = 1.6MHz$, $T_A = +25^\circ C$, FREE AIR 0 LFM

Notice

1. Descriptions of circuits, software and other related information in this document are provided only to illustrate the operation of semiconductor products and application examples. You are fully responsible for the incorporation or any other use of the circuits, software, and information in the design of your product or system. Renesas Electronics disclaims any and all liability for any losses and damages incurred by you or third parties arising from the use of these circuits, software, or information.
2. Renesas Electronics hereby expressly disclaims any warranties against and liability for infringement or any other claims involving patents, copyrights, or other intellectual property rights of third parties, by or arising from the use of Renesas Electronics products or technical information described in this document, including but not limited to, the product data, drawings, charts, programs, algorithms, and application examples.
3. No license, express, implied or otherwise, is granted hereby under any patents, copyrights or other intellectual property rights of Renesas Electronics or others.
4. You shall not alter, modify, copy, or reverse engineer any Renesas Electronics product, whether in whole or in part. Renesas Electronics disclaims any and all liability for any losses or damages incurred by you or third parties arising from such alteration, modification, copying or reverse engineering.
5. Renesas Electronics products are classified according to the following two quality grades: "Standard" and "High Quality". The intended applications for each Renesas Electronics product depends on the product's quality grade, as indicated below.
"Standard": Computers; office equipment; communications equipment; test and measurement equipment; audio and visual equipment; home electronic appliances; machine tools; personal electronic equipment; industrial robots; etc.
"High Quality": Transportation equipment (automobiles, trains, ships, etc.); traffic control (traffic lights); large-scale communication equipment; key financial terminal systems; safety control equipment; etc.
Unless expressly designated as a high reliability product or a product for harsh environments in a Renesas Electronics data sheet or other Renesas Electronics document, Renesas Electronics products are not intended or authorized for use in products or systems that may pose a direct threat to human life or bodily injury (artificial life support devices or systems; surgical implantations; etc.), or may cause serious property damage (space system; undersea repeaters; nuclear power control systems; aircraft control systems; key plant systems; military equipment; etc.). Renesas Electronics disclaims any and all liability for any damages or losses incurred by you or any third parties arising from the use of any Renesas Electronics product that is inconsistent with any Renesas Electronics data sheet, user's manual or other Renesas Electronics document.
6. When using Renesas Electronics products, refer to the latest product information (data sheets, user's manuals, application notes, "General Notes for Handling and Using Semiconductor Devices" in the reliability handbook, etc.), and ensure that usage conditions are within the ranges specified by Renesas Electronics with respect to maximum ratings, operating power supply voltage range, heat dissipation characteristics, installation, etc. Renesas Electronics disclaims any and all liability for any malfunctions, failure or accident arising out of the use of Renesas Electronics products outside of such specified ranges.
7. Although Renesas Electronics endeavors to improve the quality and reliability of Renesas Electronics products, semiconductor products have specific characteristics, such as the occurrence of failure at a certain rate and malfunctions under certain use conditions. Unless designated as a high reliability product or a product for harsh environments in a Renesas Electronics data sheet or other Renesas Electronics document, Renesas Electronics products are not subject to radiation resistance design. You are responsible for implementing safety measures to guard against the possibility of bodily injury, injury or damage caused by fire, and/or danger to the public in the event of a failure or malfunction of Renesas Electronics products, such as safety design for hardware and software, including but not limited to redundancy, fire control and malfunction prevention, appropriate treatment for aging degradation or any other appropriate measures. Because the evaluation of microcomputer software alone is very difficult and impractical, you are responsible for evaluating the safety of the final products or systems manufactured by you.
8. Please contact a Renesas Electronics sales office for details as to environmental matters such as the environmental compatibility of each Renesas Electronics product. You are responsible for carefully and sufficiently investigating applicable laws and regulations that regulate the inclusion or use of controlled substances, including without limitation, the EU RoHS Directive, and using Renesas Electronics products in compliance with all these applicable laws and regulations. Renesas Electronics disclaims any and all liability for damages or losses occurring as a result of your noncompliance with applicable laws and regulations.
9. Renesas Electronics products and technologies shall not be used for or incorporated into any products or systems whose manufacture, use, or sale is prohibited under any applicable domestic or foreign laws or regulations. You shall comply with any applicable export control laws and regulations promulgated and administered by the governments of any countries asserting jurisdiction over the parties or transactions.
10. It is the responsibility of the buyer or distributor of Renesas Electronics products, or any other party who distributes, disposes of, or otherwise sells or transfers the product to a third party, to notify such third party in advance of the contents and conditions set forth in this document.
11. This document shall not be reprinted, reproduced or duplicated in any form, in whole or in part, without prior written consent of Renesas Electronics.
12. Please contact a Renesas Electronics sales office if you have any questions regarding the information contained in this document or Renesas Electronics products.
(Note 1) "Renesas Electronics" as used in this document means Renesas Electronics Corporation and also includes its directly or indirectly controlled subsidiaries.
(Note 2) "Renesas Electronics product(s)" means any product developed or manufactured by or for Renesas Electronics.

(Rev.4.0-1 November 2017)



SALES OFFICES

Renesas Electronics Corporation

<http://www.renesas.com>

Refer to "<http://www.renesas.com/>" for the latest and detailed information.

Renesas Electronics America Inc.
1001 Murphy Ranch Road, Milpitas, CA 95035, U.S.A.
Tel: +1-408-432-8888, Fax: +1-408-434-5351

Renesas Electronics Canada Limited
9251 Yonge Street, Suite 8309 Richmond Hill, Ontario Canada L4C 9T3
Tel: +1-905-237-2004

Renesas Electronics Europe Limited
Dukes Meadow, Millboard Road, Bourne End, Buckinghamshire, SL8 5FH, U.K.
Tel: +44-1628-651-700, Fax: +44-1628-651-804

Renesas Electronics Europe GmbH
Arcadiastrasse 10, 40472 Düsseldorf, Germany
Tel: +49-211-6503-0, Fax: +49-211-6503-1327

Renesas Electronics (China) Co., Ltd.
Room 1709 Quantum Plaza, No.27 ZhichunLu, Haidian District, Beijing, 100191 P. R. China
Tel: +86-10-8235-1155, Fax: +86-10-8235-7679

Renesas Electronics (Shanghai) Co., Ltd.
Unit 301, Tower A, Central Towers, 555 Langao Road, Putuo District, Shanghai, 200333 P. R. China
Tel: +86-21-2226-0888, Fax: +86-21-2226-0999

Renesas Electronics Hong Kong Limited
Unit 1601-1611, 16/F., Tower 2, Grand Century Place, 193 Prince Edward Road West, Mongkok, Kowloon, Hong Kong
Tel: +852-2265-6688, Fax: +852-2886-9022

Renesas Electronics Taiwan Co., Ltd.
13F, No. 363, Fu Shing North Road, Taipei 10543, Taiwan
Tel: +886-2-8175-9600, Fax: +886-2-8175-9670

Renesas Electronics Singapore Pte. Ltd.
80 Bendemeer Road, Unit #06-02 Hyflux Innovation Centre, Singapore 339949
Tel: +65-6213-0200, Fax: +65-6213-0300

Renesas Electronics Malaysia Sdn.Bhd.
Unit 1207, Block B, Menara Amcorp, Amcorp Trade Centre, No. 18, Jln Persiaran Barat, 46050 Petaling Jaya, Selangor Darul Ehsan, Malaysia
Tel: +60-3-7955-9390, Fax: +60-3-7955-9510

Renesas Electronics India Pvt. Ltd.
No.777C, 100 Feet Road, HAL 2nd Stage, Indiranagar, Bangalore 560 038, India
Tel: +91-80-67208700, Fax: +91-80-67208777

Renesas Electronics Korea Co., Ltd.
17F, KAMCO Yangjae Tower, 262, Gangnam-daero, Gangnam-gu, Seoul, 06265 Korea
Tel: +82-2-558-3737, Fax: +82-2-558-5338