

ISL8240MEVAL4Z

Dual 20A/Optional 40A Cascadable Evaluation Board Setup Procedure

AN1922
Rev 3.00
September 29, 2015

The ISL8240MEVAL4Z is a complete, dual step-down switching mode DC/DC module. The dual outputs can easily be paralleled for single-output, high current use. It is easy to apply this high power, current sharing DC/DC power module to power hungry datacom, telecom and FPGA applications. All that is needed in order to have a complete, dual 20A design ready for use are the [ISL8240M](#), a few passive components and V_{OUT} setting resistors.

The simplicity of the ISL8240M is its off-the-shelf, unassisted implementation. Patented current sharing in multi phase operation greatly reduces ripple currents, BOM costs and complexity. The ISL8240M has a thermally enhanced, compact 17mmx17mmx7.5mm QFN package that operates at full load and over-temperature. Easy access to all pins, with few external components, reduces PCB design to a component layer and a simple ground layer.

This ISL8240MEVAL4Z evaluation board is designed for dual 20A output applications. Optionally, this board can easily be converted for 40A single output use. Multiple ISL8240MEVAL4Z boards can be cascadable through the SYNC and CLKOUT pins to operate with phase shifting, for paralleling or multiple output use. The input voltage of this board is 4.5V to 20V and the default outputs on this board are set at 1.0V and 1.5V.

Recommended Equipment

- 0V to 20V power supply with at least 5A source current capability
- Electronic load capable of sinking current up to 40A
- Digital Multimeters (DMMs)
- 100MHz quad-trace oscilloscope

Quick Start

For dual output operation, the inputs are BA7 (VIN1), BA8 (GND), BA3 (VIN2) and BA4 (GND). The outputs are BA5 (VOUT1), BA6 (GND), BA1 (VOUT2) and BA2 (GND).

For paralleled single output operation, the inputs are BA7 (VIN1) and BA8 (GND). The outputs are BA5 (VOUT1) and BA6 (GND) with BA5 and BA1 shorted.

Ordering Information

PART NUMBER	DESCRIPTION
ISL8240MEVAL4Z	Evaluation Board

References

- [ISL8240M](#) datasheet.



FIGURE 1. ISL8240MEVAL4Z BOARD IMAGE

Dual Output Mode

1. Connect a power supply capable of sourcing at least 5A to inputs BA7 (VIN1), BA8 (GND), BA3 (VIN2) and BA4 (GND) of the ISL8240MEVAL4Z evaluation board, with a voltage between 4.5V to 20V. VIN1 and VIN2 can be different with R₁₈ and R₁₉ open.
2. Connect an electronic load or device to be powered to the outputs BA5 (VOUT1), BA6 (GND), BA1 (VOUT2) and BA2 (GND) of the board. All connections, especially the low voltage, high current V_{OUT} lines, should be able to carry the desired load current and should be made as short as possible.
3. Make sure that the setup is connected correctly. Turn on the power supply. If the board is working properly, the green LED will illuminate; if not, the red LED will illuminate (recheck the wire/jumper connections in this case). Measure the output voltages, V_{OUT1}, which should be at 1.0V and V_{OUT2}, which should be at 1.5V.
4. If different output voltages are desired, board resistors can be exchanged to provide the desired V_{OUT}. Please refer to [Table 1](#) for R₂/R₄ resistor values, which can be used to produce different output voltages.

The switching frequency is set to 500kHz by default. The switching frequency can be adjusted, as recommended in [Table 1](#). By changing the resistor R_{FSET}, the desired frequency can be adjusted. If the output voltage is set to ≥1.5V, the output current will need to be derated at certain conditions to allow for safe operation. Please refer to the [ISL8240M](#) datasheet.

TABLE 1. VALUE OF BOTTOM RESISTOR (TOP RESISTOR R₁, R₃ = 1kΩ) AND FREQUENCY SELECTION FOR DIFFERENT OUTPUT VOLTAGES

V _{OUT} (V)	R ₂ /R ₄ (Ω)	FREQUENCY (kHz)	R _{FSET} (kΩ) (V _{IN} = 12V)
1.0	1500	500	237
1.2	1000	550	174
1.5	665	600	140
1.8	499	650	115
2.5	316	700	100

Optional Paralleled Single Output Mode

1. To set up the parallel mode, short JP1 (ENC), JP2 (VMON) and JP3 (COMP) with a jumper. To set up 180° interleaving phase between 2 channels, short the MODE pin and GND pin of JP6 with a jumper.
2. Remove R₉ and R₁₃. Change R₁₄ to 0Ω. Change R₁₈ and R₁₉ to 0Ω. Short VOUT1 to VOUT2 using short wires or copper straps. Add C₂ for a 470pF capacitor.
3. Connect a power supply capable of sourcing at least 5A to the inputs BA7 (VIN1), BA8 (GND), BA3 (VIN2) and BA4 (GND) of the ISL8240MEVAL4Z evaluation board, with a voltage between 4.5V to 20V. VIN1 and VIN2 need to be shorted together.

4. Connect an electronic load or the device to be powered to the outputs BA5 (VOUT1) and BA6 (GND) of the board. All connections, especially the low voltage, high current V_{OUT} lines, should be able to carry the desired load current and should be made as short as possible.
5. Make sure the setup is connected correctly prior to applying any power to the board. Adjust the power supply to 12V and turn on the input power supply. If the board is working properly, the green LED will illuminate; if not, the red LED will illuminate (recheck the wire/jumper connections in this case). Measure the output voltages, V_{OUT1}, which should be at 1.0V.
6. Apply any load that is less than 40A for normal steady state operation. Refer to [Table 1](#) to change the output voltage by changing resistor R₂.

TABLE 2. BOARD CONFIGURATION FOR SINGLE OUTPUT 40A APPLICATION

	ENC	VMON	MODE	COMP	R9	R13	R14
Dual	OPEN	OPEN	OPEN	OPEN	0	0	OPEN
Single	ON	ON	ON	ON	OPEN	OPEN	0

For optimized performance of a 2-phase single output application of the ISL8240M, please refer to application note [AN1923](#).

Optional Cascadable Mode

Cascadable mode is needed when multiple evaluation boards are used for paralleling or multiple output use. Follow the steps shown below:

1. In order to generate CLKOUT at a shifted phase clock signal, the control loop of VOUT2 needs to be disabled by connecting VSEN2- to VCC.
2. Program MODE and VSEN2+ pin voltages to set the CLKOUT signal and the shifted degrees between two phases on the board (refer to [Table 3](#) on [page 4](#)).
3. Use a coaxial cable to connect CLKOUT (J5) to SYNC (J2) of the next evaluation board, which can be programmed for parallel or dual output use.
4. If the second board is programmed for parallel use, the ISHARE pins of the first and second boards need to be tied together. Using two twisted wires, short two different jumpers of JP7 (ISHARE/SGND) on two evaluation boards. Add 1nF capacitors of C₁₄ for different boards to decouple the noise.
5. If the third board is used in cascadable mode, the second board can only be used in the parallel mode to generate the CLKOUT signal for the SYNC pin on the third board.
6. Follow the instructions from Steps 1 through 5 for more cascadable boards.

Evaluation Board Information

The evaluation board size is 114.3mmx76.2mm. It is a 4-layer board, containing 2-ounce copper on the top and bottom layers and 2-ounce copper on all internal layers. The board can be used as a dual 20A reference design. Refer to "[Layout](#)" on page 6. The board is made of FR4 material and all components, including the solder attachment, are lead-free.

Thermal Considerations and Current Derating

For high current applications, board layout is very critical in order to make the module operate safely and deliver maximum allowable power. To carry large currents, the board layout needs to be designed carefully to maximize thermal performance. To achieve this, use sufficient trace width, copper weight and the proper connectors.

This evaluation board is designed for running dual 20A at room temperature without additional cooling systems needed. However, if the output voltage is increased or the board is operated at elevated temperatures, then the available current is derated. Refer to the derated current curves in the [ISL8240M](#) datasheet to determine the output current available.

For layout of designs using the ISL8240M, the thermal performance can be improved by adhering to the following design tips:

1. Use the top and bottom layers to carry the large current. VOUT1, VOUT2, Phase 1, Phase 2, PGND, VIN1 and VIN2 should have large, solid planes. Place enough thermal vias to connect the power planes in different layers under and around the module.
2. Phase 1 and Phase 2 pads are switching nodes that generate switching noise. Keep these pads under the module. For noise-sensitive applications, it is recommended to keep phase pads only on the top and inner layers of the PCB; do not place phase pads exposed to the outside on the bottom layer of the PCB. To improve the thermal performance, the phase pads can be extended in the inner layer, as shown in Phase 1 and Phase 2 pads on layer 2 ([Figure 5](#)) for this dual 20A evaluation board. Make sure that layer 1 and layer 3 have the GND layers to cover the extended areas of phase pads at layer 2 to avoid noise coupling.
3. Place the modules evenly on the board and leave enough space between modules. If the board space is limited, try to put the modules with low power loss closely together (i.e. low V_{OUT} or I_{OUT}) while still separating the module with high power loss.
4. If the ambient temperature is high or the board space is limited, airflow is needed to dissipate more heat from the modules. A heatsink can also be applied to the top side of the module to further improve the thermal performance (heatsink recommendation: Aavid Thermalloy, part number 375424B00034G, www.aavid.com).

TABLE 3. ISL8240M OPERATION MODES

1ST MODULE (I = INPUT; O = OUTPUT; I/O = INPUT AND OUTPUT, BI-DIRECTION)										MODES OF OPERATION		OUTPUT (see Description for details)
MODE	EN1/FF1 (I)	EN2/FF2 (I)	VSEN2- (I)	MODE (I)	VSEN2+ (I)	CLKOUT/REFIN WRT 1 ST (I OR O)	VMON2 (Note 2)	VMON1 OF 2 ND MODULE (Note 2)	2 ND CHANNEL WRT 1 ST (O) (Note 1)	OPERATION MODE OF 2 ND MODULE	OPERATION MODE OF 3 RD MODULE	
1	0	0	-	-	-	-	-	-	-	-	-	Disabled
2A	0	1	Active	Active	Active	-	Active	-	VMON1 = VMON2 to Keep PGOOD Valid	-	-	Single Phase
2B	1	0	-	-	-	-	-	-	VMON1 = VMON2 to Keep PGOOD Valid	-	-	Single Phase
3A	1	1	<V _{CC} -0.7V	Active	Active	29% to 45% of V _{CC} (I)	Active	-	0°	-	-	Dual Regulator
3B	1	1	<V _{CC} -0.7V	Active	Active	45% to 62% of V _{CC} (I)	Active	-	90°	-	-	Dual Regulator
3C	1	1	<V _{CC} -0.7V	Active	Active	>62% of V _{CC} (I)	Active	-	180°	-	-	Dual Regulator
4	1	1	<V _{CC} -0.7V	Active	Active	<29% of V _{CC} (I)	Active	-	-60°	-	-	DDR Mode
5A	1	1	V _{CC}	GND	-	60°	VMON1 or Divider	-	180°	-	-	2-Phase
5B	1	1	V _{CC}	GND	-	60°	Divider	Divider	180°	5B	5B	6-Phase
5C	1	1	V _{CC}	GND	-	60°	VMON1 or Divider	Active	180°	5C	5C	3 Outputs
6	1	1	V _{CC}	V _{CC}	GND	120°	1kΩ	Active	240°	2B	-	3-Phase
7A	1	1	V _{CC}	V _{CC}	V _{CC}	90°	1kΩ	Divider	180°	7A	-	4-Phase
7B	1	1	V _{CC}	V _{CC}	V _{CC}	90°	1kΩ	Active	180°	7B	-	2 Outputs (1 st module in Mode 7A)
7C	1	1	V _{CC}	V _{CC}	V _{CC}	90°	1kΩ	Active	180°	3, 4	-	3 Outputs (1 st module in Mode 7A)
8	Cascaded Module Operation MODEs 5B+5B+7A+5B+5B+5B/7A, No External Clock Required											12-Phase
9	External Clock or External Logic Circuits Required for Equal Phase Interval											5, 7, 8, 9, 10, 11, or (PHASE >12)

NOTES:

1. "2ND CHANNEL WRT 1ST" means "second channel with respect to first;" in other words, Channel 2 lags Channel 1 by the degrees specified in this column. For example, 90° means Channel 2 lags Channel 1 by 90°; -60° means Channel 2 leads Channel 1 by 60°.
2. "VMON1" means that the pin is tied to the VMON1 pin of the same module.
"Divider" means that there is a resistor divider from VOUT to SGND; refer to Figure 25 in the [ISL8240M](#) datasheet.
"1kΩ" means that there is a 1kΩ resistor connecting the pin to SGND; refer to Figure 23 in the [ISL8240M](#) datasheet.

ISL8240MEVAL4Z Board Schematic

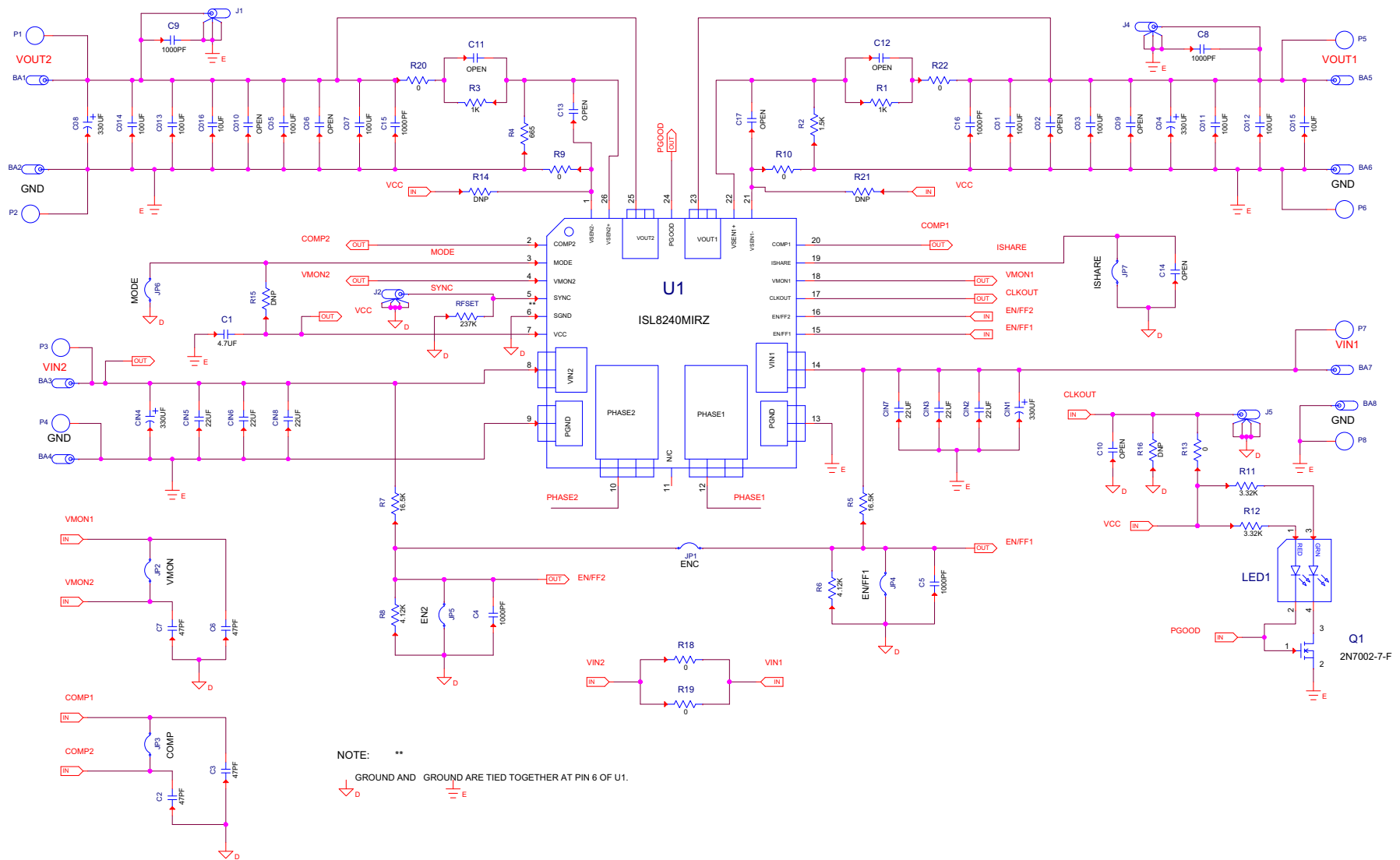

FIGURE 2. ISL8240MEVAL4Z BOARD SCHEMATIC

Layout

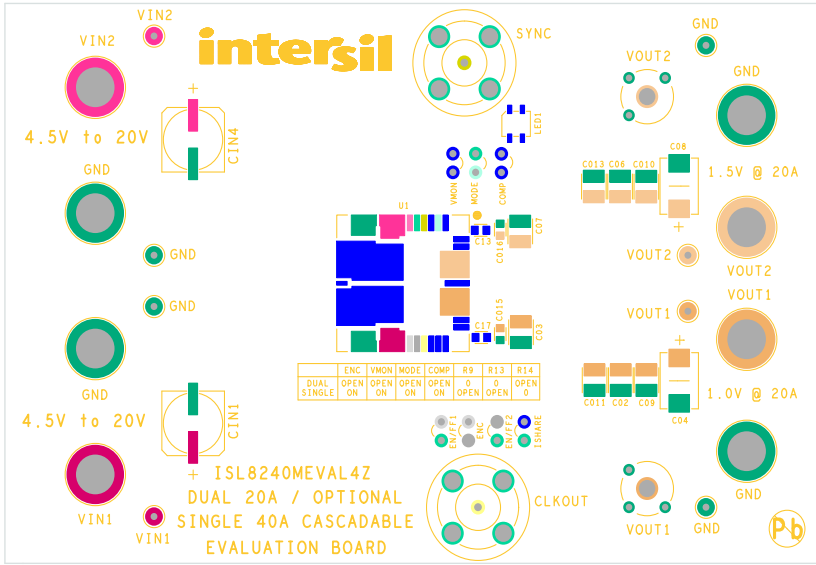

FIGURE 3. TOP SILKSCREEN

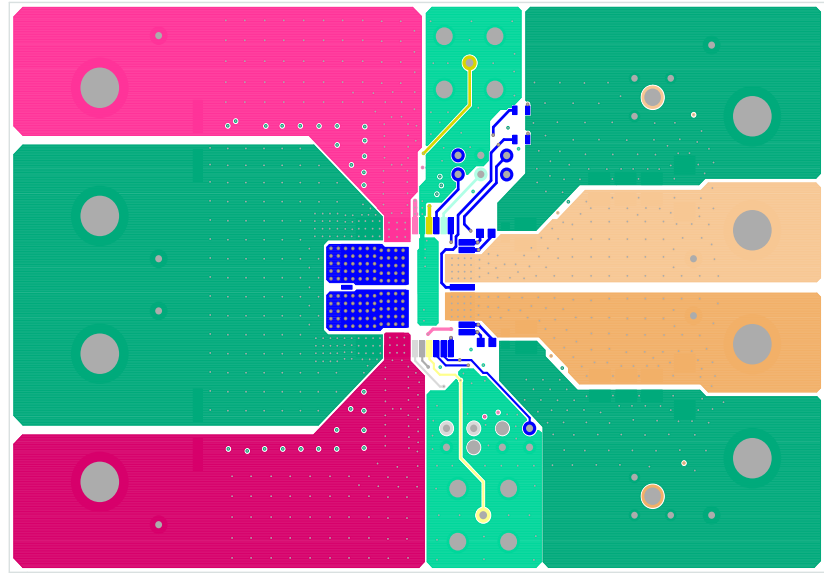

FIGURE 4. TOP LAYER COMPONENT SIDE

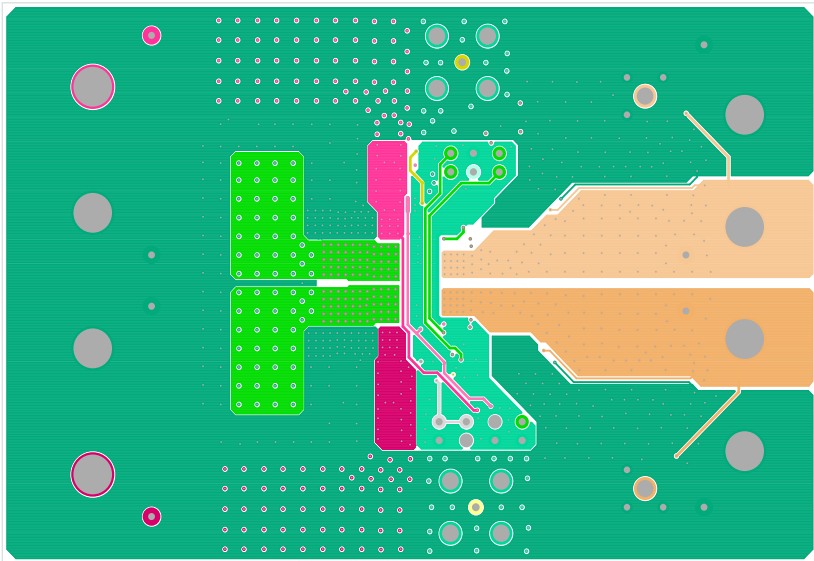

FIGURE 5. LAYER 2

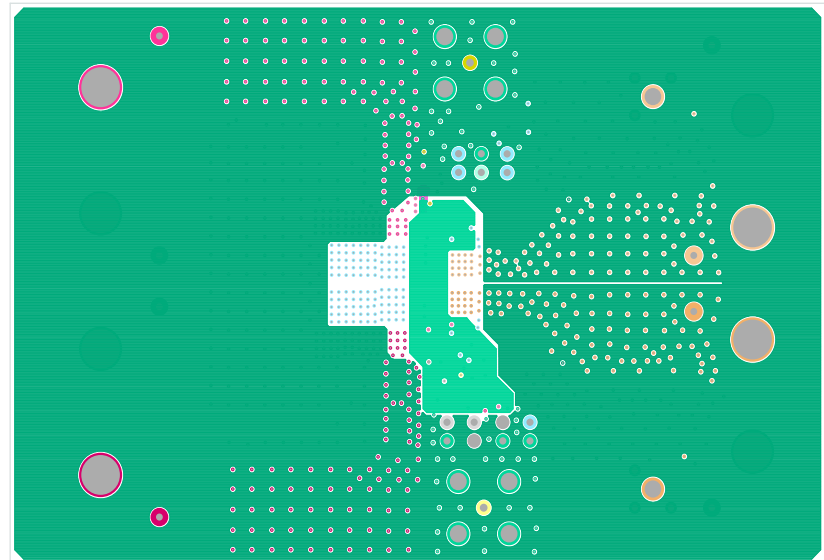

FIGURE 6. LAYER 3

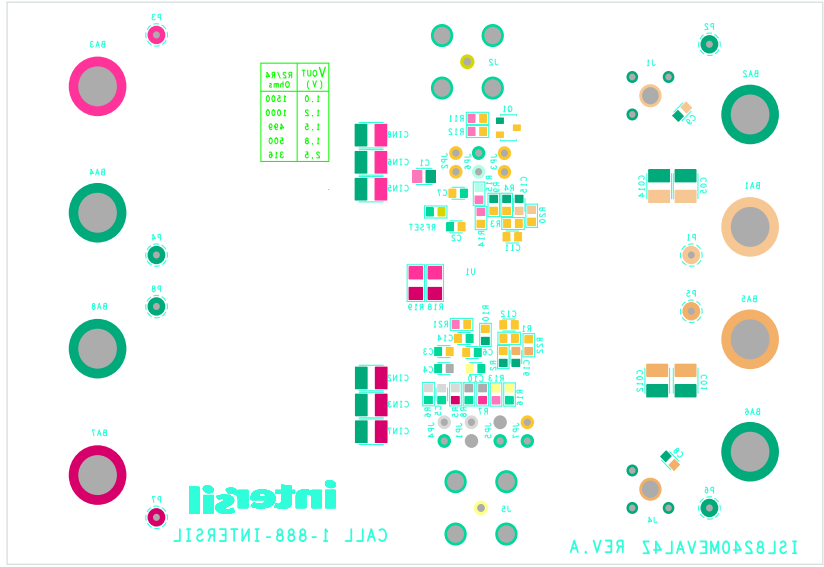

FIGURE 8. BOTTOM SILKSCREEN

Layout (Continued)

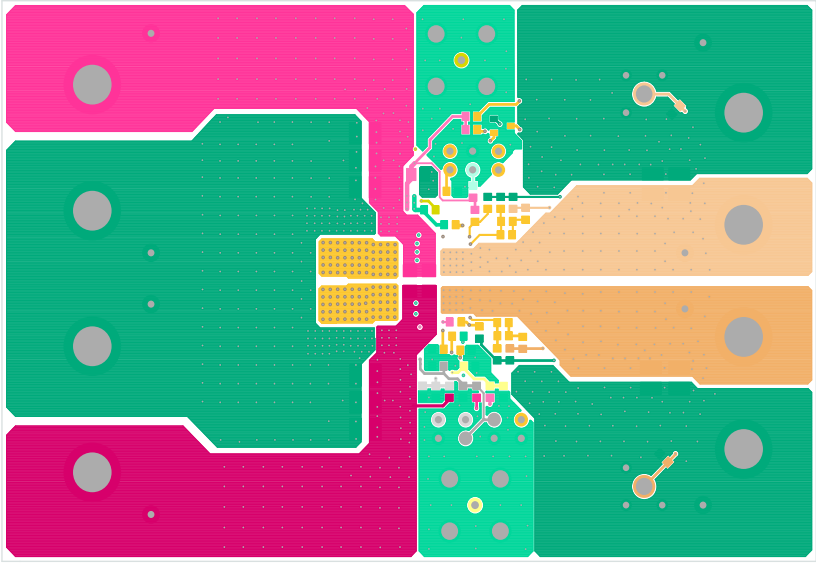

FIGURE 7. BOTTOM LAYER SOLDER SIDE

Bill of Materials

PART NUMBER	REF DES	QTY	VALUE	TOL (%)	VOLTAGE	POWER	PACKAGE TYPE	JEDEC TYPE	MANUFACTURER	DESCRIPTION
575-4	BA1, BA2, BA3, BA4, BA5, BA6, BA7, BA8	8					CONN	CON_BAN_575		
GRM21BR71C475KA73L	C1	1	4.7µF	10	16V		805	CAP_0805	Murata	Ceramic Capacitor
H1045-OPEN	C2, C3, C6, C7	4	OPEN		OPEN		603	CAP_0603	Generic	Multilayer Capacitor
H1045-00102-50V10	C4, C5, C8, C9	4	1000pF	10	50V		603	CAP_0603	Generic	Multilayer Capacitor
H1045-OPEN	C10, C11, C12, C13, C14, C17	6	OPEN		OPEN		603	CAP_0603	Generic	Multilayer Capacitor
H1045-00102-16V10	C15, C16	2	1000pF	10	16V		603	CAP_0603	Generic	Multilayer Capacitor
H1082-00107-6R3V20-T	C01, C03, C05, C07, C011, C012, C013, C014	8	100µF	20	6.3V		1210	CAP_1210	TDK	Ceramic Chip Capacitor
H1082-OPEN	C02, C06, C09, C10	4	OPEN		OPEN		1210	CAP_1210	Generic	Ceramic Chip Capacitor
6TPF330M9L	C04, C08	2	330µF	20	6.3V		SMD	CAP_7343_149	Sanyo	Tantalum Polymer Capacitor
EEVHA1E331UP	CIN1, CIN4	2	330µF	20	25V		SMD	CAPAE_315X402	Panasonic	
TMK325B7226MM-TR	CIN2, CIN3, CIN5, CIN6, CIN7, CIN8	6	22µF	20	25V		1210	CAP_1210	Taiyo Yuden	Ceramic Chip Capacitor
131-4353-00	J1, J4	2					CONN	TEK131-4353-00		
31-5329-52RFX	J2, J5	2					CONN	CON_BNC_31_5329_52RFX		
JUMPER2_100	JP1-JP7	7					THOLE	JUMPER-1		
SSL-LXA3025IGC	LED1	1					SMD	LED_3X2_5MM		
5002	P1, P2, P3, P4, P5, P6, P7, P8	8					THOLE	MTP500X		
2N7002-7-F	Q1	1					SOT23	SOT23		
H2511-01001-1/10W1	R1, R3	2	1kΩ	1		1/10W	603	RES_0603		Chip Resistor
H2511-01501-1/10W1	R2	1	1.5kΩ	1		1/10W	603	RES_0603		Chip Resistor
H2511-06650-1/10W1	R4	1	665Ω	1		1/10W	603	RES_0603		Chip Resistor
H2511-06650-1/10W1	R5, R7	2	16.5Ω	1		1/10W	603	RES_0603		Chip Resistor
H2511-06650-1/10W1	R6, R8	2	4.12kΩ	1		1/10W	603	RES_0603		Chip Resistor
H2511-06650-1/10W1	R9, R10, R13, R20, R22	5	0Ω	1		1/10W	603	RES_0603		Chip Resistor
H2511-06650-1/10W1	R11, R12	2	3.32kΩ	1		1/10W	603	RES_0603		Chip Resistor
H2505-DNP-DNP-1	R14, R15, R16, R21	4	OPEN				603	RES_0603		Chip Resistor
H2513-00R00-1/4W	R18, R19	2	0Ω	1		1/4W	1206	RES_1206		Chip Resistor
H2511-02373-1/10W1	RFSET	1	237kΩ	1		1/10W	603	RES_0603		Chip Resistor
ISL8240MIRZ	U1	1					QFN			

ISL8240MEVAL4Z Performance

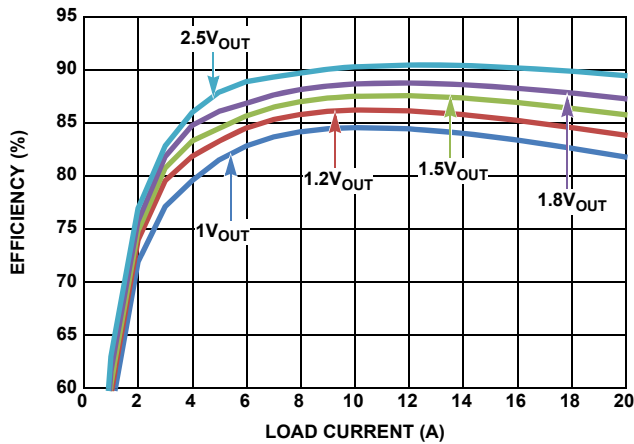

FIGURE 9. EFFICIENCY VS LOAD CURRENT (12V_{IN})

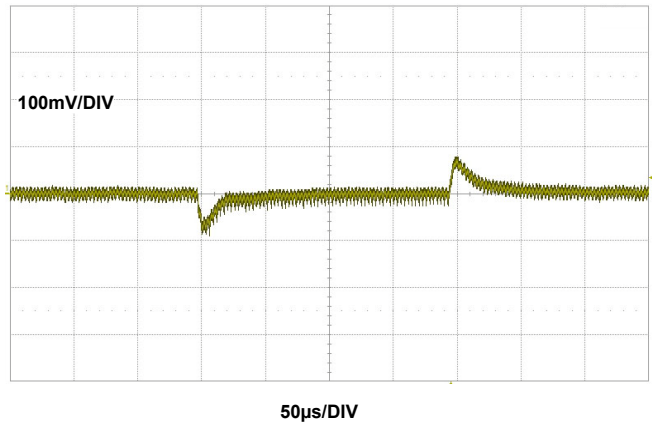

FIGURE 10. 1V_{OUT} TRANSIENT RESPONSE, I_{OUT} = 0A TO 10A, F_{SW} = 350KHZ LOAD CURRENT SLEW RATE 10A/MS

Notice

1. Descriptions of circuits, software and other related information in this document are provided only to illustrate the operation of semiconductor products and application examples. You are fully responsible for the incorporation or any other use of the circuits, software, and information in the design of your product or system. Renesas Electronics disclaims any and all liability for any losses and damages incurred by you or third parties arising from the use of these circuits, software, or information.
2. Renesas Electronics hereby expressly disclaims any warranties against and liability for infringement or any other claims involving patents, copyrights, or other intellectual property rights of third parties, by or arising from the use of Renesas Electronics products or technical information described in this document, including but not limited to, the product data, drawings, charts, programs, algorithms, and application examples.
3. No license, express, implied or otherwise, is granted hereby under any patents, copyrights or other intellectual property rights of Renesas Electronics or others.
4. You shall not alter, modify, copy, or reverse engineer any Renesas Electronics product, whether in whole or in part. Renesas Electronics disclaims any and all liability for any losses or damages incurred by you or third parties arising from such alteration, modification, copying or reverse engineering.
5. Renesas Electronics products are classified according to the following two quality grades: "Standard" and "High Quality". The intended applications for each Renesas Electronics product depends on the product's quality grade, as indicated below.
"Standard": Computers; office equipment; communications equipment; test and measurement equipment; audio and visual equipment; home electronic appliances; machine tools; personal electronic equipment; industrial robots; etc.
"High Quality": Transportation equipment (automobiles, trains, ships, etc.); traffic control (traffic lights); large-scale communication equipment; key financial terminal systems; safety control equipment; etc.
Unless expressly designated as a high reliability product or a product for harsh environments in a Renesas Electronics data sheet or other Renesas Electronics document, Renesas Electronics products are not intended or authorized for use in products or systems that may pose a direct threat to human life or bodily injury (artificial life support devices or systems; surgical implantations; etc.), or may cause serious property damage (space system; undersea repeaters; nuclear power control systems; aircraft control systems; key plant systems; military equipment; etc.). Renesas Electronics disclaims any and all liability for any damages or losses incurred by you or any third parties arising from the use of any Renesas Electronics product that is inconsistent with any Renesas Electronics data sheet, user's manual or other Renesas Electronics document.
6. When using Renesas Electronics products, refer to the latest product information (data sheets, user's manuals, application notes, "General Notes for Handling and Using Semiconductor Devices" in the reliability handbook, etc.), and ensure that usage conditions are within the ranges specified by Renesas Electronics with respect to maximum ratings, operating power supply voltage range, heat dissipation characteristics, installation, etc. Renesas Electronics disclaims any and all liability for any malfunctions, failure or accident arising out of the use of Renesas Electronics products outside of such specified ranges.
7. Although Renesas Electronics endeavors to improve the quality and reliability of Renesas Electronics products, semiconductor products have specific characteristics, such as the occurrence of failure at a certain rate and malfunctions under certain use conditions. Unless designated as a high reliability product or a product for harsh environments in a Renesas Electronics data sheet or other Renesas Electronics document, Renesas Electronics products are not subject to radiation resistance design. You are responsible for implementing safety measures to guard against the possibility of bodily injury, injury or damage caused by fire, and/or danger to the public in the event of a failure or malfunction of Renesas Electronics products, such as safety design for hardware and software, including but not limited to redundancy, fire control and malfunction prevention, appropriate treatment for aging degradation or any other appropriate measures. Because the evaluation of microcomputer software alone is very difficult and impractical, you are responsible for evaluating the safety of the final products or systems manufactured by you.
8. Please contact a Renesas Electronics sales office for details as to environmental matters such as the environmental compatibility of each Renesas Electronics product. You are responsible for carefully and sufficiently investigating applicable laws and regulations that regulate the inclusion or use of controlled substances, including without limitation, the EU RoHS Directive, and using Renesas Electronics products in compliance with all these applicable laws and regulations. Renesas Electronics disclaims any and all liability for damages or losses occurring as a result of your noncompliance with applicable laws and regulations.
9. Renesas Electronics products and technologies shall not be used for or incorporated into any products or systems whose manufacture, use, or sale is prohibited under any applicable domestic or foreign laws or regulations. You shall comply with any applicable export control laws and regulations promulgated and administered by the governments of any countries asserting jurisdiction over the parties or transactions.
10. It is the responsibility of the buyer or distributor of Renesas Electronics products, or any other party who distributes, disposes of, or otherwise sells or transfers the product to a third party, to notify such third party in advance of the contents and conditions set forth in this document.
11. This document shall not be reprinted, reproduced or duplicated in any form, in whole or in part, without prior written consent of Renesas Electronics.
12. Please contact a Renesas Electronics sales office if you have any questions regarding the information contained in this document or Renesas Electronics products.
(Note 1) "Renesas Electronics" as used in this document means Renesas Electronics Corporation and also includes its directly or indirectly controlled subsidiaries.
(Note 2) "Renesas Electronics product(s)" means any product developed or manufactured by or for Renesas Electronics.

(Rev.4.0-1 November 2017)



SALES OFFICES

Renesas Electronics Corporation

<http://www.renesas.com>

Refer to "<http://www.renesas.com/>" for the latest and detailed information.

Renesas Electronics America Inc.
1001 Murphy Ranch Road, Milpitas, CA 95035, U.S.A.
Tel: +1-408-432-8888, Fax: +1-408-434-5351

Renesas Electronics Canada Limited
9251 Yonge Street, Suite 8309 Richmond Hill, Ontario Canada L4C 9T3
Tel: +1-905-237-2004

Renesas Electronics Europe Limited
Dukes Meadow, Millboard Road, Bourne End, Buckinghamshire, SL8 5FH, U.K
Tel: +44-1628-651-700, Fax: +44-1628-651-804

Renesas Electronics Europe GmbH
Arcadiastrasse 10, 40472 Düsseldorf, Germany
Tel: +49-211-6503-0, Fax: +49-211-6503-1327

Renesas Electronics (China) Co., Ltd.
Room 1709 Quantum Plaza, No.27 ZhichunLu, Haidian District, Beijing, 100191 P. R. China
Tel: +86-10-8235-1155, Fax: +86-10-8235-7679

Renesas Electronics (Shanghai) Co., Ltd.
Unit 301, Tower A, Central Towers, 555 Langao Road, Putuo District, Shanghai, 200333 P. R. China
Tel: +86-21-2226-0888, Fax: +86-21-2226-0999

Renesas Electronics Hong Kong Limited
Unit 1601-1611, 16/F., Tower 2, Grand Century Place, 193 Prince Edward Road West, Mongkok, Kowloon, Hong Kong
Tel: +852-2265-6688, Fax: +852-2886-9022

Renesas Electronics Taiwan Co., Ltd.
13F, No. 363, Fu Shing North Road, Taipei 10543, Taiwan
Tel: +886-2-8175-9600, Fax: +886-2-8175-9670

Renesas Electronics Singapore Pte. Ltd.
80 Bendemeer Road, Unit #06-02 Hyflux Innovation Centre, Singapore 339949
Tel: +65-6213-0200, Fax: +65-6213-0300

Renesas Electronics Malaysia Sdn.Bhd.
Unit 1207, Block B, Menara Amcorp, Amcorp Trade Centre, No. 18, Jln Persiaran Barat, 46050 Petaling Jaya, Selangor Darul Ehsan, Malaysia
Tel: +60-3-7955-9390, Fax: +60-3-7955-9510

Renesas Electronics India Pvt. Ltd.
No.777C, 100 Feet Road, HAL 2nd Stage, Indiranagar, Bangalore 560 038, India
Tel: +91-80-67208700, Fax: +91-80-67208777

Renesas Electronics Korea Co., Ltd.
17F, KAMCO Yangjae Tower, 262, Gangnam-daero, Gangnam-gu, Seoul, 06265 Korea
Tel: +82-2-558-3737, Fax: +82-2-558-5338