

JESD204B High Speed ADC

Evaluation Kit

AN1809
Rev 0.00
Dec 5, 2012

The Intersil JESD204B High Speed ADC evaluation system allows users to evaluate the Intersil portfolio of low-power, 12- to 16-bit, high-performance analog-to-digital converters (ADC) with JESD204B high speed serial outputs. These converters run at sampling rates of 40MSPS to 500MSPS and their JESD204B outputs operate at rates from 1 to 4.375Gbps. The evaluation system uses the Intersil iEvalADC software, which displays all pertinent data such as SFDR, SINAD, ENOB, harmonics, current, and power measurements. The software also plots outputs in frequency spectra and time domain.

To begin testing, simply connect the input signal, sampling clock, and target computer to the motherboard, and supply power (Figure 1). The motherboard (ADCMB-HSFMCEV1Z) provides appropriate supply voltages and captures digital data from the daughter card. Daughter cards contain the ADCs and attach directly to the motherboard to form the ADC evaluation platform (Figure 2). To ensure proper operation of the system, it is recommended that the most current software version be installed. If Intersil iEvalADC is already installed on the machine, a new installation may proceed without removing the prior version.

Features

- Complete high-speed ADC measurement solution
- 40MSPS to 500MSPS operation
- Datasheet-style, live-updated display with calculation of critical ADC parameters (SNR, SFDR, SINAD, ENOB, Harmonics, Power)
- Multiple display modes: frequency (FFT), time domain
- Integrated SPI control for ADC configuration
- JESD204B receiver reference design (included with iEvalADC software)
- USB 2.0 interface for rapid data transfer
- 1M (2²⁰) word capture depth

Evaluation System Contents

The evaluation system is provided with a USB cable to connect to a PC and a 5V power supply. The user need only provide signal and clock sources, optional filters, and a PC running the Microsoft Windows™ XP operating system with Java installed. Intersil iEvalADC software can be downloaded from the Intersil web site. Please visit www.intersil.com/jesd204b for more details.

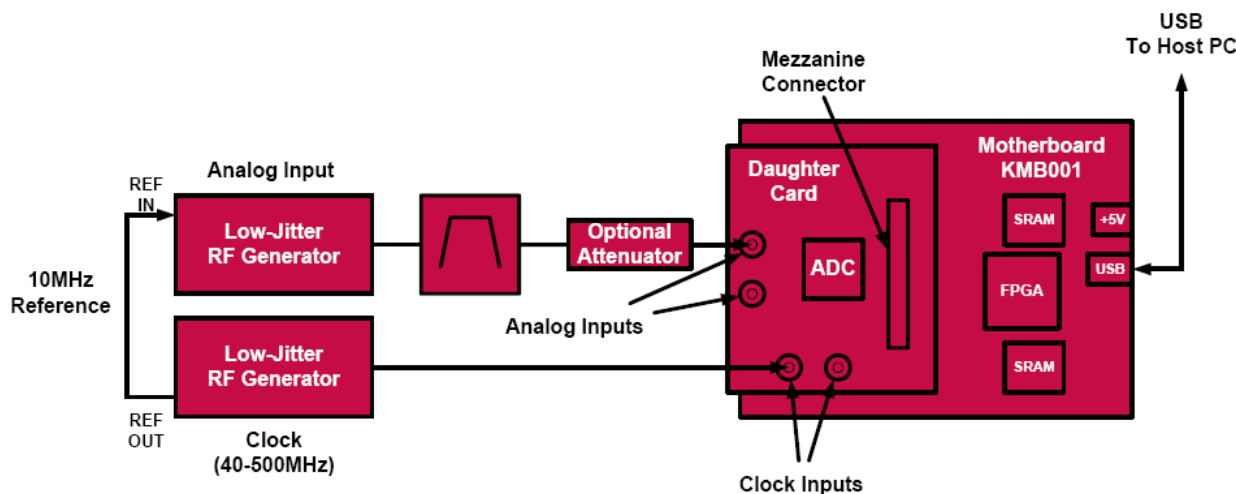

FIGURE 1. EVALUATION PLATFORM BLOCK DIAGRAM

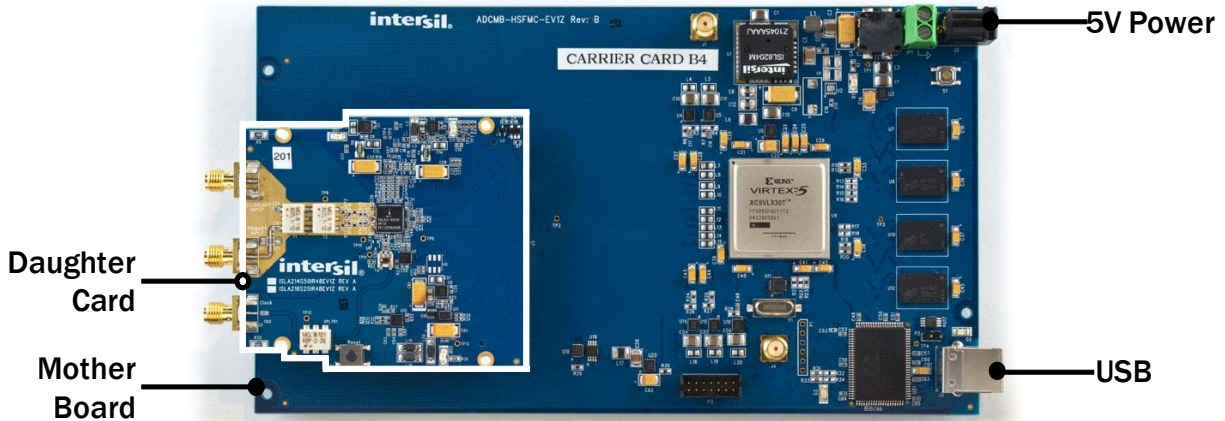

FIGURE 2. EXAMPLE EVALUATION BOARD CONNECTIONS SHOWING ISLA214S50 DAUGHTER CARD

Installation Requirements

Before installing iEvalADC, please confirm the following:

- PC operating system is Windows XP
- The account that the software is installed from has administrator privileges.
- Java is installed.
 - The Java Runtime Environment is installed on the PC. If not, it can be installed by downloading from <http://java.com/>
 - Windows XP has associated files with the *.jar extension with the java runtime environment. This is done by default during the java runtime environment install. You can modify your file extension associations by opening an explore window, clicking on the Tools drop down menu, selecting Folder Options, and interacting with the pop up window.

Setup and Operation of the ADC Evaluation Platform

To set up the ADC evaluation platform, the following items are required:

1. Intersil ADCMB-HSFMCEV1Z motherboard
2. USB cable (USB-A to USB-B, 1.25 to 2M long) (supplied with ADCMB-HSFMCEV1Z)
3. 5V power supply, 18 W minimum (supplied with ADCMB-HSFMCEV1Z)
4. Intersil daughter card containing ADC to be tested (ordered separately)
5. Suitable signal and clock sources (see “Appendix A” on page 4)(supplied by user)
6. PC with free USB2.0 port, logged in with administrator rights (supplied by user)

Installing the iEvalADC Software

1. Double click the installer executable (i.e., “Intersil_iEvalADC_V1.04.exe”). This will launch the installer, resulting in the following window. Click “Next”.

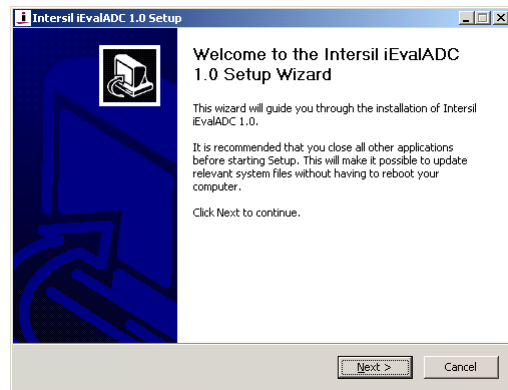

FIGURE 3.

2. The End User License Agreement will be displayed. In the License Agreement window, if you agree with the Software Evaluation License Agreement, click “I accept the terms of the License Agreement” radio button, then click “Next”.

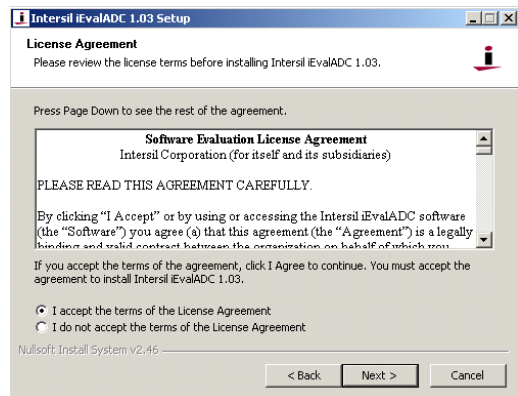

FIGURE 4.

3. The “Choose Install Location” window opens. Click "Next".

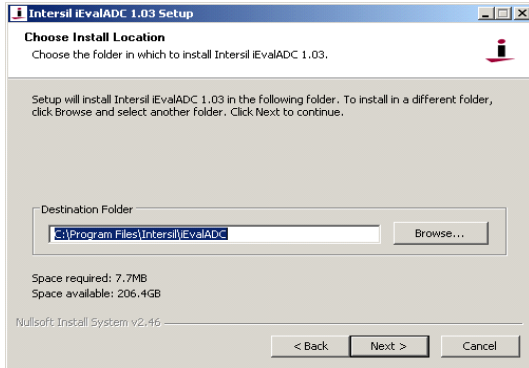

FIGURE 5.

4. The “Choose Start Menu Folder” opens. Click “Install”.

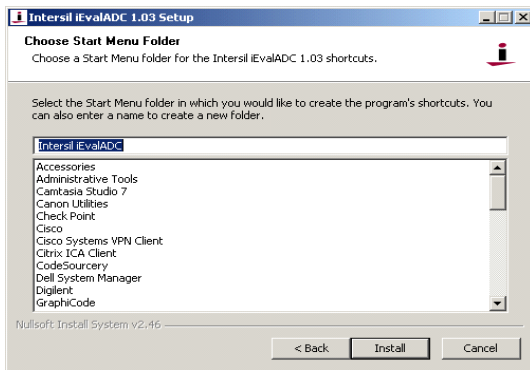

FIGURE 6.

5. The “Completing the Intersil iEvalADC Setup Wizard” window opens. Click “Finish”.

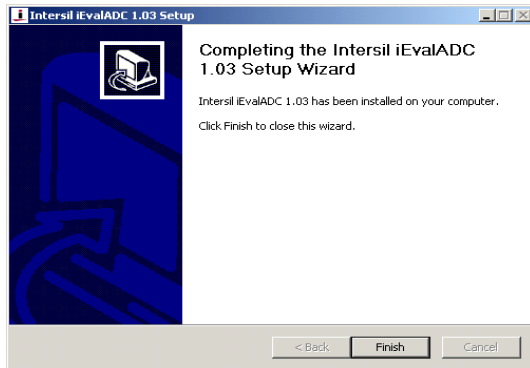

FIGURE 7.

6. Setup the hardware as shown in Figure 1.

7. Windows will automatically detect the new hardware and prompt for the appropriate driver via the “Found New Hardware Wizard”. Click “No, not this time”, then click "Next".



FIGURE 8.

8. The Software Installation wizard window will open. Click the “Install the software automatically (Recommended)” radio button, then click "Next".

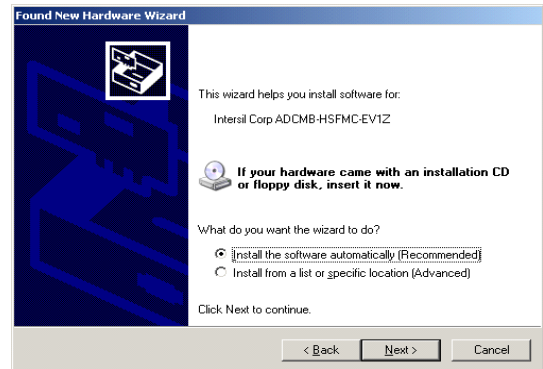

FIGURE 9.

9. The “Completing the Found New Hardware Wizard” window will open. Click “Finish”. (For common issues encountered during this process and solutions to these issues, please refer to “Appendix B” on page 4).



FIGURE 10.

10. Double click on the iEvalADC shortcut on the desktop to launch the application.

Running the Software

Once the installation is complete, the software can be launched by double clicking on the shortcut located on the desktop, by default called “iEvalADC”. There is no need to attach the evaluation kit hardware to launch the software. The first time the program is launched, you may experience a delay as the Java runtime environment unpacks the required libraries. Subsequent runs will be much shorter. A window similar to the following will be displayed once iEvalADC has launched.

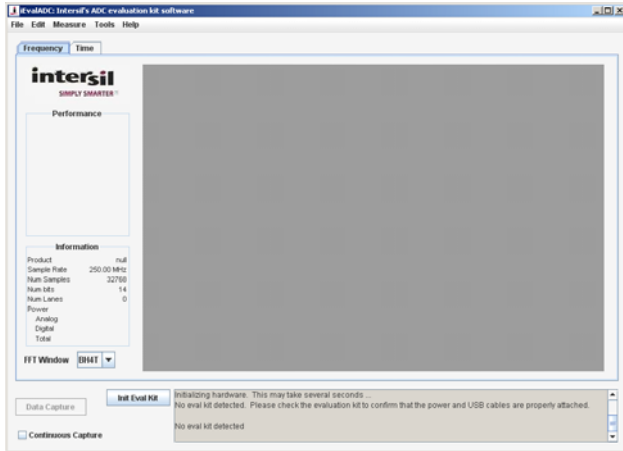

FIGURE 11.

Thank you for installing the iEvalADC software. For a complete user guide for iEvalADC, please refer to [Application Note 1809](#).

Appendix A

Source Requirements

Source jitter and noise will degrade performance. For best test results, a combined jitter (for both clock and signal sources) that does not exceed 200fs is recommended.

Sample Clock and Input Signal Source Setup

Sample clock settings:

- 40MHz to 500MHz sine, +10dBm

Signal settings:

- 4.5MHz to 250MHz, +10dBm to +16dBm (depending on analog input attenuation)

Appendix B

Sometimes there are multiple drivers that match the VID/PID characteristics of the hardware. In those cases, a window similar to the following will be displayed when trying to automatically install the driver. When this occurs, select the driver with the location of “c:\windows\inf\lcyusb.inf” and click “Next”.

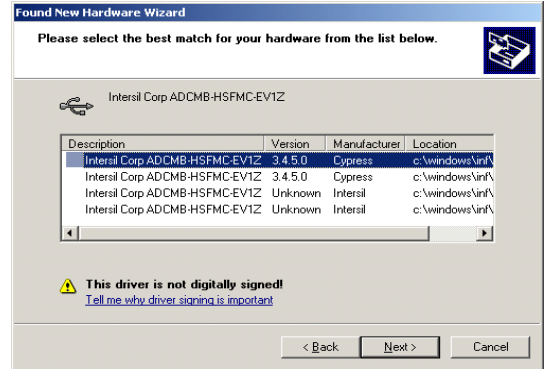

FIGURE 12.

Occasionally, windows will prompt for the 'ICYUSB.sys' file after selecting the icyusb.inf file. If so, the prompt will look something like the window displayed in Figure 13. If this prompt is displayed, fill in the install directory of iEvalADC along with the subdirectory, lib. Alternatively, browse to this directory. If you accepted the defaults during installation, the correct path will be C:\Program Files\Intersil\iEvalADC\lib. After entering the appropriate directory, click “OK”, then, click “Search for the best driver in these locations”. Also, make sure the check box “Include this location in the search” is selected and the directory highlighted is the install directory of iEvalADC with the “lib” subdirectory, and click “Next” or “OK”.

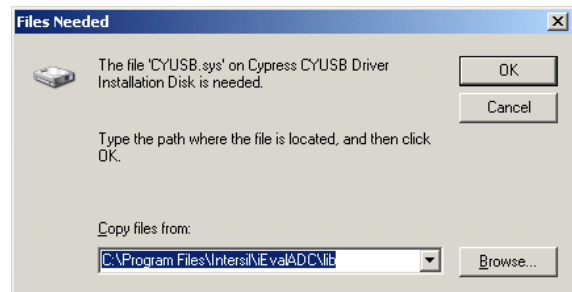

FIGURE 13.

Notice

1. Descriptions of circuits, software and other related information in this document are provided only to illustrate the operation of semiconductor products and application examples. You are fully responsible for the incorporation or any other use of the circuits, software, and information in the design of your product or system. Renesas Electronics disclaims any and all liability for any losses and damages incurred by you or third parties arising from the use of these circuits, software, or information.
2. Renesas Electronics hereby expressly disclaims any warranties against and liability for infringement or any other claims involving patents, copyrights, or other intellectual property rights of third parties, by or arising from the use of Renesas Electronics products or technical information described in this document, including but not limited to, the product data, drawings, charts, programs, algorithms, and application examples.
3. No license, express, implied or otherwise, is granted hereby under any patents, copyrights or other intellectual property rights of Renesas Electronics or others.
4. You shall not alter, modify, copy, or reverse engineer any Renesas Electronics product, whether in whole or in part. Renesas Electronics disclaims any and all liability for any losses or damages incurred by you or third parties arising from such alteration, modification, copying or reverse engineering.
5. Renesas Electronics products are classified according to the following two quality grades: "Standard" and "High Quality". The intended applications for each Renesas Electronics product depends on the product's quality grade, as indicated below.
"Standard": Computers; office equipment; communications equipment; test and measurement equipment; audio and visual equipment; home electronic appliances; machine tools; personal electronic equipment; industrial robots; etc.
"High Quality": Transportation equipment (automobiles, trains, ships, etc.); traffic control (traffic lights); large-scale communication equipment; key financial terminal systems; safety control equipment; etc.
Unless expressly designated as a high reliability product or a product for harsh environments in a Renesas Electronics data sheet or other Renesas Electronics document, Renesas Electronics products are not intended or authorized for use in products or systems that may pose a direct threat to human life or bodily injury (artificial life support devices or systems; surgical implantations; etc.), or may cause serious property damage (space system; undersea repeaters; nuclear power control systems; aircraft control systems; key plant systems; military equipment; etc.). Renesas Electronics disclaims any and all liability for any damages or losses incurred by you or any third parties arising from the use of any Renesas Electronics product that is inconsistent with any Renesas Electronics data sheet, user's manual or other Renesas Electronics document.
6. When using Renesas Electronics products, refer to the latest product information (data sheets, user's manuals, application notes, "General Notes for Handling and Using Semiconductor Devices" in the reliability handbook, etc.), and ensure that usage conditions are within the ranges specified by Renesas Electronics with respect to maximum ratings, operating power supply voltage range, heat dissipation characteristics, installation, etc. Renesas Electronics disclaims any and all liability for any malfunctions, failure or accident arising out of the use of Renesas Electronics products outside of such specified ranges.
7. Although Renesas Electronics endeavors to improve the quality and reliability of Renesas Electronics products, semiconductor products have specific characteristics, such as the occurrence of failure at a certain rate and malfunctions under certain use conditions. Unless designated as a high reliability product or a product for harsh environments in a Renesas Electronics data sheet or other Renesas Electronics document, Renesas Electronics products are not subject to radiation resistance design. You are responsible for implementing safety measures to guard against the possibility of bodily injury, injury or damage caused by fire, and/or danger to the public in the event of a failure or malfunction of Renesas Electronics products, such as safety design for hardware and software, including but not limited to redundancy, fire control and malfunction prevention, appropriate treatment for aging degradation or any other appropriate measures. Because the evaluation of microcomputer software alone is very difficult and impractical, you are responsible for evaluating the safety of the final products or systems manufactured by you.
8. Please contact a Renesas Electronics sales office for details as to environmental matters such as the environmental compatibility of each Renesas Electronics product. You are responsible for carefully and sufficiently investigating applicable laws and regulations that regulate the inclusion or use of controlled substances, including without limitation, the EU RoHS Directive, and using Renesas Electronics products in compliance with all these applicable laws and regulations. Renesas Electronics disclaims any and all liability for damages or losses occurring as a result of your noncompliance with applicable laws and regulations.
9. Renesas Electronics products and technologies shall not be used for or incorporated into any products or systems whose manufacture, use, or sale is prohibited under any applicable domestic or foreign laws or regulations. You shall comply with any applicable export control laws and regulations promulgated and administered by the governments of any countries asserting jurisdiction over the parties or transactions.
10. It is the responsibility of the buyer or distributor of Renesas Electronics products, or any other party who distributes, disposes of, or otherwise sells or transfers the product to a third party, to notify such third party in advance of the contents and conditions set forth in this document.
11. This document shall not be reprinted, reproduced or duplicated in any form, in whole or in part, without prior written consent of Renesas Electronics.
12. Please contact a Renesas Electronics sales office if you have any questions regarding the information contained in this document or Renesas Electronics products.
(Note 1) "Renesas Electronics" as used in this document means Renesas Electronics Corporation and also includes its directly or indirectly controlled subsidiaries.
(Note 2) "Renesas Electronics product(s)" means any product developed or manufactured by or for Renesas Electronics.

(Rev.4.0-1 November 2017)



SALES OFFICES

Renesas Electronics Corporation

<http://www.renesas.com>

Refer to "<http://www.renesas.com/>" for the latest and detailed information.

Renesas Electronics America Inc.
1001 Murphy Ranch Road, Milpitas, CA 95035, U.S.A.
Tel: +1-408-432-8888, Fax: +1-408-434-5351

Renesas Electronics Canada Limited
9251 Yonge Street, Suite 8309 Richmond Hill, Ontario Canada L4C 9T3
Tel: +1-905-237-2004

Renesas Electronics Europe Limited
Dukes Meadow, Millboard Road, Bourne End, Buckinghamshire, SL8 5FH, U.K
Tel: +44-1628-651-700, Fax: +44-1628-651-804

Renesas Electronics Europe GmbH
Arcadiastrasse 10, 40472 Düsseldorf, Germany
Tel: +49-211-6503-0, Fax: +49-211-6503-1327

Renesas Electronics (China) Co., Ltd.
Room 1709 Quantum Plaza, No.27 ZhichunLu, Haidian District, Beijing, 100191 P. R. China
Tel: +86-10-8235-1155, Fax: +86-10-8235-7679

Renesas Electronics (Shanghai) Co., Ltd.
Unit 301, Tower A, Central Towers, 555 Langao Road, Putuo District, Shanghai, 200333 P. R. China
Tel: +86-21-2226-0888, Fax: +86-21-2226-0999

Renesas Electronics Hong Kong Limited
Unit 1601-1611, 16/F., Tower 2, Grand Century Place, 193 Prince Edward Road West, Mongkok, Kowloon, Hong Kong
Tel: +852-2265-6688, Fax: +852-2886-9022

Renesas Electronics Taiwan Co., Ltd.
13F, No. 363, Fu Shing North Road, Taipei 10543, Taiwan
Tel: +886-2-8175-9600, Fax: +886-2-8175-9670

Renesas Electronics Singapore Pte. Ltd.
80 Bendemeer Road, Unit #06-02 Hyflux Innovation Centre, Singapore 339949
Tel: +65-6213-0200, Fax: +65-6213-0300

Renesas Electronics Malaysia Sdn.Bhd.
Unit 1207, Block B, Menara Amcorp, Amcorp Trade Centre, No. 18, Jln Persiaran Barat, 46050 Petaling Jaya, Selangor Darul Ehsan, Malaysia
Tel: +60-3-7955-9390, Fax: +60-3-7955-9510

Renesas Electronics India Pvt. Ltd.
No.777C, 100 Feet Road, HAL 2nd Stage, Indiranagar, Bangalore 560 038, India
Tel: +91-80-67208700, Fax: +91-80-67208777

Renesas Electronics Korea Co., Ltd.
17F, KAMCO Yangjae Tower, 262, Gangnam-daero, Gangnam-gu, Seoul, 06265 Korea
Tel: +82-2-558-3737, Fax: +82-2-558-5338