

IS-1825xSRH, IS-1825BSEH, ISL71823xSRH

Single Event and Total Dose Hardened, High-Speed Dual Output PWMs

 FN9065
 Rev.7.00
 Dec 15, 2017

The [IS-1825ASRH](#), [IS-1825BSRH](#), [IS-1825BSEH](#), [ISL71823ASRH](#), and [ISL71823BSRH](#) are single event and total dose hardened pulse width modulators designed to be used in high-frequency switching power supplies in either voltage or current-mode configurations. These devices include a precision voltage reference, a low power start-up circuit, a high-frequency oscillator, a wide-band error amplifier, and a fast current-limit comparator.

The IS-1825xSRH and IS-1825xSEH feature dual, alternating output operating from zero to less than 50% duty cycle, and the ISL71823xSRH features dual in-phase output operating from zero to less than 100% duty cycle. The B versions of the parts test the delay from clock out to PWM output switching after power has been applied to the modulator (t_{PWM}) (see [Figure 2 on page 9](#)). The SEH parts are wafer-by-wafer acceptance tested to 50krad(Si) at a low dose rate of <10mrads(Si)/s.

Constructed with the Rad-hard Silicon Gate (RSG) dielectrically isolated BiCMOS process, these devices are immune to single-event latch-up and have been specifically designed to provide a high level of immunity to single-event transients. All specified parameters are established and tested for 300krad(Si) total dose performance.

The devices are offered in a 16 Ld CDIP or a 20 Ld CDFP and fully specified to across the temperature range of -50°C to +125°C.

Applications

- Voltage or current mode switching power supplies
- Control of high current MOSFET drivers
- Motor speed and direction control

Features

- Electrically screened to DLA SMD [5962-02511](#)
- QML qualified per MIL-PRF-38535 requirements
- EH version is wafer-by-wafer acceptance tested to 50krad(Si) LDR
- Oscillator frequency: 1MHz (max)
- High output drive current: 1A peak (typ)
- Low startup current: 300µA (max)
- Undervoltage Lockout
 - Start threshold: 8.8V (max)
 - Stop threshold: 7.6V (min)
 - Hysteresis: 300mV (min)
- Pulse-by-pulse current limiting
- Programmable leading edge blanking
- Radiation Hardness
 - High Dose Rate (HDR) (50-300rad(Si)/s): 300krad(Si)
 - Low Lose Rate (LDR) (0.01rad(Si)/s): 50krad(Si)
 - Latch-up immune (dielectrically isolated)
 - SEU immune: LET= 35MeV•cm²/mg

Related Literature

- For a full list of related documents, visit our website
- [IS-1825ASRH](#), [IS-1825BSRH](#), [IS-1825BSEH](#), [ISL71823ASRH](#), and [ISL71823BSRH](#) product pages

Table 1. Key Differences Between Family of Parts

Part Number	Dual Outputs	Radiation Hardened Assurance Testing		Clock-to-PWM Startup Test
		TID HDR Rating (50-300 rad(Si)/s)	TID LDR Rating (<10mrads(Si)/s)	
IS-1825ASRH	Out of Phase	300krad(Si)	-	-
IS-1825BSRH	Out of Phase	300krad(Si)	-	Yes
IS-1825BSEH	Out of Phase	300krad(Si)	50krad(Si)	Yes
ISL71823ASRH	In Phase	300krad(Si)	-	-
ISL71823BSRH	In Phase	300krad(Si)	-	Yes

Contents

1. Overview	3
1.1 Functional Block Diagram	3
1.2 Ordering Information	4
1.3 Pin Configuration	5
1.4 Pin Descriptions	5
2. Specifications	6
2.1 Absolute Maximum Ratings	6
2.2 Thermal Information	6
2.3 Recommended Operating Conditions	6
2.4 Electrical Specifications	7
2.5 Timing Diagram	9
3. Typical Performance Curves	10
4. Die and Assembly Characteristics	19
4.1 Metallization Mask Layout	20
4.2 Bond Pad Coordinates	21
5. Revision History	22
6. Package Outline Drawings	23
6.1 Ceramic Metal Seal Flatpack Packages (Flatpack)	23
6.2 Ceramic Dual-In-Line Metal Seal Packages (SBDIP)	24

1. Overview

1.1 Functional Block Diagram

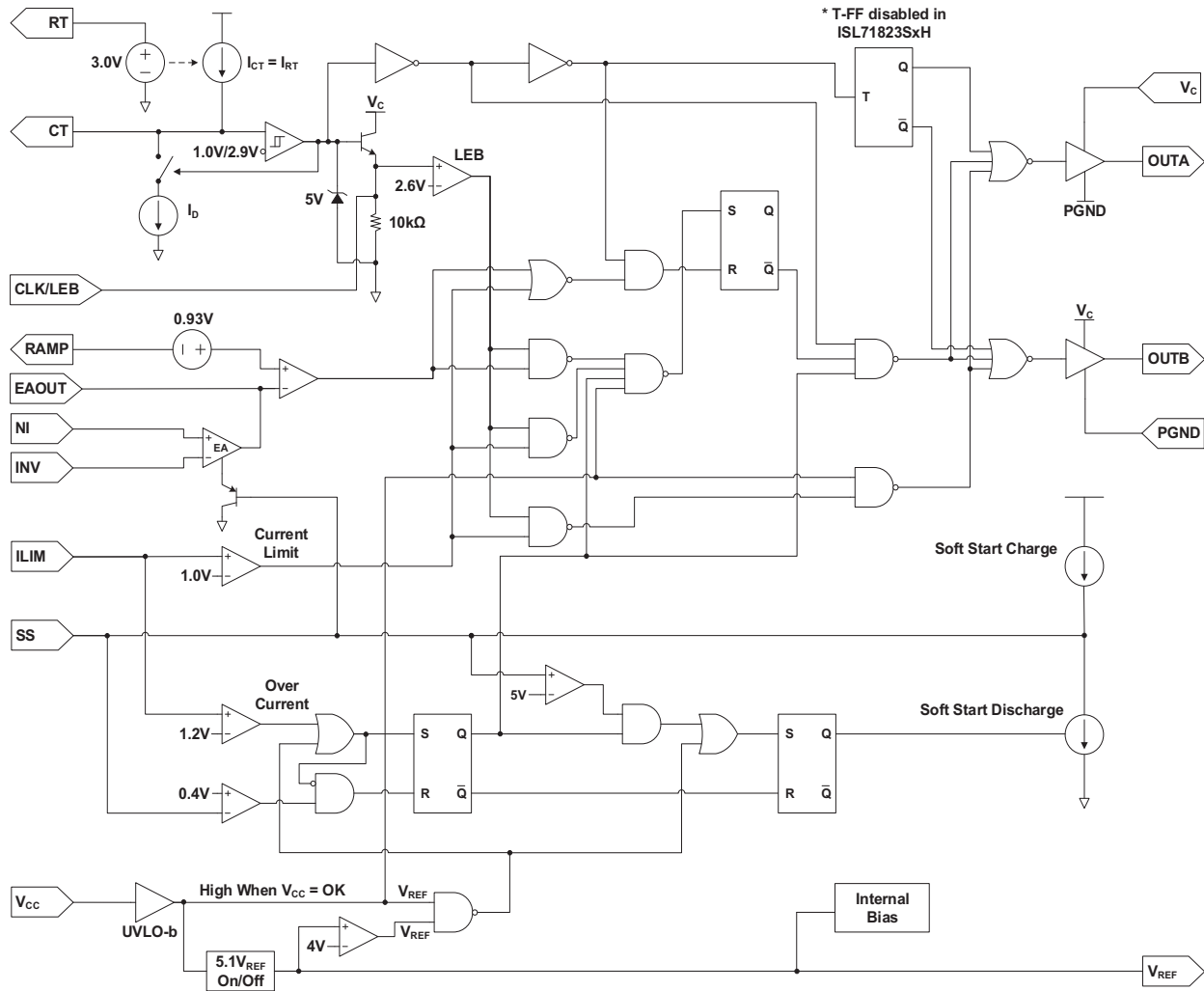

Figure 1. Block Diagram

1.2 Ordering Information

Ordering SMD Number (Note 1)	Part Number (Note 2)	Radiation Hardness Assurance		Temperature Range (°C)	Package (RoHS Compliant)	Package Drawing
		HDR	LDR			
N/A	IS0-1825ASRH/SAMPLE (Note 3)	-	-	-50 to +125	DIE	-
5962F0251101V9A	IS0-1825ASRH-Q	300krad(Si)	-	-50 to +125	DIE	-
5962F0251101QEC	IS1-1825ASRH-8	300krad(Si)	-	-50 to +125	16 Ld SBDIP	D16.3
5962F0251101QXC	IS9-1825ASRH-8	300krad(Si)	-	-50 to +125	20 Ld FP	K20.A
5962F0251101VEC	IS1-1825ASRH-Q	300krad(Si)	-	-50 to +125	16 Ld SBDIP	D16.3
5962F0251101VXC	IS9-1825ASRH-Q	300krad(Si)	-	-50 to +125	20 Ld FP	K20.A
N/A	IS1-1825ASRH/PROTO (Note 3)	-	-	-50 to +125	16 Ld SBDIP	D16.3
N/A	IS9-1825ASRH/PROTO (Note 3)	-	-	-50 to +125	20 Ld FP	K20.A
5962F0251102QEC	ISL71823ASRHQD	300krad(Si)	-	-50 to +125	16 Ld SBDIP	D16.3
5962F0251102QXC	ISL71823ASRHQF	300krad(Si)	-	-50 to +125	20 Ld FP	K20.A
5962F0251102VEC	ISL71823ASRHVD	300krad(Si)	-	-50 to +125	16 Ld SBDIP	D16.3
5962F0251102VXC	ISL71823ASRHVF	300krad(Si)	-	-50 to +125	20 Ld FP	K20.A
5962F0251102V9A	ISL71823ASRHX	300krad(Si)	-	-50 to +125	DIE	-
N/A	ISL71823ASRHD/PROTO (Note 3)	-	-	-50 to +125	16 Ld SBDIP	D16.3
N/A	ISL71823ASRHF/PROTO (Note 3)	-	-	-50 to +125	20 Ld FP	K20.A
N/A	ISL71823ASRHX/SAMPLE (Note 3)	-	-	-50 to +125	DIE	-
5962F0251103V9A	IS0-1825BSRH-Q	300krad(Si)	-	-50 to +125	DIE	-
5962F0251103QEC	IS1-1825BSRH-8	300krad(Si)	-	-50 to +125	16 Ld SBDIP	D16.3
5962F0251103QXC	IS9-1825BSRH-8	300krad(Si)	-	-50 to +125	20 Ld FP	K20.A
5962F0251103VEC	IS1-1825BSRH-Q	300krad(Si)	-	-50 to +125	16 Ld SBDIP	D16.3
5962F0251103VXC	IS9-1825BSRH-Q	300krad(Si)	-	-50 to +125	20 Ld FP	K20.A
5962F0251104QEC	ISL71823BSRHQD	300krad(Si)	-	-50 to +125	16 Ld SBDIP	D16.3
5962F0251104QXC	ISL71823BSRHQF	300krad(Si)	-	-50 to +125	20 Ld FP	K20.A
5962F0251104VEC	ISL71823BSRHVD	300krad(Si)	-	-50 to +125	16 Ld SBDIP	D16.3
5962F0251104VXC	ISL71823BSRHVF	300krad(Si)	-	-50 to +125	20 Ld FP	K20.A
5962F0251104V9A	ISL71823BSRHX	300krad(Si)	-	-50 to +125	DIE	-
5962F0251105V9A	IS0-1825BSEH-Q	300krad(Si)	50krad(Si)	-50 to +125	DIE	-
5962F0251105VEC	IS1-1825BSEH-Q	300krad(Si)	50krad(Si)	-50 to +125	16 Ld SBDIP	D16.3
5962F0251105VXC	IS9-1825BSEH-Q	300krad(Si)	50krad(Si)	-50 to +125	20 Ld FP	K20.A

Notes:

- Specifications for Rad Hard QML devices are controlled by the Defense Logistics Agency Land and Maritime (DLA). The SMD numbers listed must be used when ordering.
- These Pb-free Hermetic packaged products employ 100% Au plate - e4 termination finish, which is RoHS compliant and compatible with both SnPb and Pb-free soldering operations.
- The /PROTO and /SAMPLE are not rated or certified for Total Ionizing Dose (TID) or Single Event Effect (SEE) immunity. These parts are intended for engineering evaluation purposes only. The /PROTO parts meet the electrical limits and conditions across the temperature range specified in the DLA SMD and are in the same form and fit as the qualified device. The /SAMPLE die is capable of meeting the electrical limits and conditions specified in the DLA SMD at +25°C only. The /SAMPLE is a die and does not receive 100% screening across the temperature range to the DLA SMD electrical limits. These part types do not come with a certificate of conformance because there is no radiation assurance testing and they are not DLA qualified devices.

1.3 Pin Configuration

IS1-1825ASRH, IS1-1825BSRH, IS-1825BSEH
ISL71823BSRHVD, ISL71823ASRHQD
(CDIP2-T16 SBDIP)
TOP VIEW

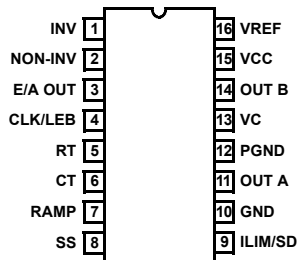

IS9-1825ASRH, IS9-1825BSRH, IS9-1825BSEH
ISL71823ASRHQF, ISL71823BSRHVF
(CDFP4-F20 FLATPACK)
TOP VIEW

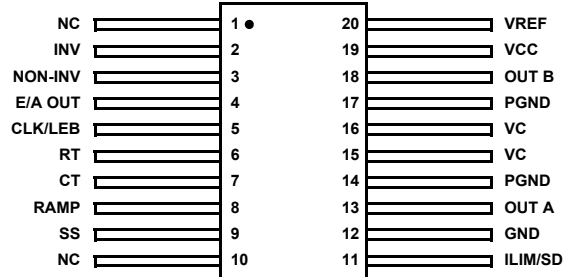

1.4 Pin Descriptions

Pin Name	Pin Number		Description
	SBDIP	Flatpack	
INV	1	2	Inverting input for the error amplifier.
NON-INV	2	3	Non inverting input for the error amplifier.
E/A OUT	3	4	Error amplifier output.
CLK/LEB	4	5	Clock out pin with leading edge blanking.
R_T	5	6	Timing resistor pin for programming the oscillator.
C_T	6	7	Timing capacitor pin for programming the oscillator.
RAMP	7	8	Non inverting input to the PWM comparator with a 1.25V internal offset.
SS	8	9	Soft-Start pin for controlling startup ramp time and inrush current.
ILIM/SD	9	11	Input to the current limit comparator.
GND	10	12	Ground return for the analog circuitry.
OUTA	11	13	High current totem pole output of the driver stage.
PGND	12	14, 17	Ground return for the output driver stage.
V_C	13	15, 16	Power supply pin for the output stage. Bypass this pin with a 0.1 μ F capacitor with low ESL and minimize the trace length by placing it as close to the pin as possible.
OUTB	14	18	High current totem pole output of the driver stage.
V_{CC}	15	19	Power supply pin for the device. Bypass this pin with a 0.1 μ F capacitor with low ESL and minimize the trace length by placing it as close to the pin as possible.
V_{REF}	16	20	5.1V voltage reference.
NC	-	1, 10	Not electrically connected.

2. Specifications

2.1 Absolute Maximum Ratings

Parameter	Minimum	Maximum	Unit
V_C, V_{CC}	-	35	V
Analog Inputs (INV, NON-INV, RAMP, ILIM/SD, SS)	-0.3	$V_{CC} + 0.3$	V
Power Dissipation	-	714	mW

CAUTION: Do not operate at or near the maximum ratings listed for extended periods of time. Exposure to such conditions may adversely impact product reliability and result in failures not covered by warranty.

2.2 Thermal Information

Thermal Resistance (Typical)	θ_{JA} (°C/W)	θ_{JC} (°C/W)
CDIP Package D16.3 (Notes 4, 5)	70	18
CDFP Package K20.A (Notes 4, 5)	80	15

Notes:

- θ_{JA} is measured with the component mounted on a high-effective thermal conductivity test board in free air. See [TB379](#).
- For θ_{JC} , the "case temp" location is the center of the package underside.

Parameter	Minimum	Maximum	Unit
Maximum Junction Temperature		+175	°C
Storage Temperature Range	-65	+150	°C
Lead Temperature (Soldering 10 seconds)	-	+260	°C

2.3 Recommended Operating Conditions

Parameter	Minimum	Maximum	Unit
Temperature	-50	+125	°C
V_C, V_{CC}	12	20	V

2.4 Electrical Specifications

Unless otherwise noted, $V_S = V_C = V_{CC} = 12V$, $R_T = 3.65k\Omega$, $C_T = 1nF$, $T_A = +25^\circ C$. **Boldface limits apply across the operating temperature range, $-50^\circ C$ to $+125^\circ C$; over a total ionizing dose of $300krad(Si)$ with exposure at a high dose rate of 50 to $300rad(Si)/s$; or over a total ionizing dose of $75krad(Si)$ with exposure at a low dose rate of $<10mrad(Si)/s$ (SEH devices only).**

Parameter	Symbol	Test Conditions	Min (Note 7)	Typ	Max (Note 7)	Unit
Reference Section						
Output Voltage	V_{REF}		5.00	5.10	5.20	V
			4.92	-	5.28	V
Line Regulation	V_{LINE}	$12.0V < V_S < 20.0V$	-15	6.2	15	mV
			-20	-	20	mV
Load Regulation	V_{LOAD}	$1.0mA < I_{OUT} < 10.0mA$	-25	2.7	25	mV
			50	-	50	mV
Total Output Variation	V_{OM}	$V_S = 12.0V, 20.0V,$ $I_{OUT} = 1.0mA, 10.0mA$	5.00	5.10	5.20	V
			4.92	-	5.28	V
Short Circuit Current	I_{SC}	$V_{REF} = 0V$	30	64	-	mA
			20	-	-	
Oscillator Section						
Initial Accuracy	F_O		340	379	425	kHz
			300	-	425	kHz
Voltage Stability	F_{PSRR}	$12.0V < V_S < 20.0V, T_A = +25^\circ C$	-3	-0.4	3	%
		$12.0V < V_S < 20.0V, T_A = -55^\circ C, +125^\circ C$	-5	-	5	%
		$12.0V < V_S < 20.0V, T_A = +25^\circ C, \text{Post Rad}$	-3	-	3	%
Total Variation	F_{OM}	$V_S = 12.0V, 20.0V$	340	366	425	kHz
			300	-	425	kHz
Clock Out High Voltage	V_{CLKH}		4.00	4.41	-	V
			3.75	-	-	V
Clock Out Low Voltage	V_{CLKL}		-	5.8	200	mV
CT Ramp Peak Voltage	$V_{CT(PEAK)}$		-	2.9	-	V
CT Ramp Valley Voltage	$V_{CT(VALLEY)}$		-	1.0	-	V
Error Amplifier Section						
Input Offset Voltage	V_{OS}	$V_{CM} = 3.0V, V_O = 3.0V$	-10	0.66	10	mV
Input Bias Current	I_{IBAS}	$V_{CM} = 3.0V, V_O = 3.0V$	-2	-0.44	2	μA
Input Offset Current	I_{OS}	$V_{CM} = 3.0V, V_O = 3.0V$	-2	0.07	2	μA
Open Loop Gain	A_{VOL}	$1.0V < V_O < 4.0V$	60	117	-	dB
Common Mode Rejection Ratio	CMRR	$1.5V < V_{CM} < 4.0V, T_A = +25^\circ C$	65	100	-	dB
		$1.5V < V_{CM} < 4.0V, T_A = -55^\circ C, +125^\circ C$	45	-	-	dB
		$1.5V < V_{CM} < 4.0V, T_A = +25^\circ C, \text{Post Rad}$	65	-	-	dB
Power Supply Rejection Ratio	PSRR	$12.0V < V_S < 20.0V$	70	119	-	dB
Gain-Bandwidth Product	GBWP		-	13	-	MHz
Output Sink Current	I_{OL}	$V_{E/A OUT} = 1.0V$	1	11	-	mA
Output Source Current	I_{OH}	$V_{E/A OUT} = 4.0V$	-0.5	-9	-	mA
Output High Voltage	$V_{E/A OH}$	$I_{E/A OUT} = -0.5mA$	4	4.6	-	V

Unless otherwise noted, $V_S = V_C = V_{CC} = 12V$, $R_T = 3.65k\Omega$, $C_T = 1nF$, $T_A = +25^\circ C$. **Boldface limits apply across the operating temperature range, $-50^\circ C$ to $+125^\circ C$; over a total ionizing dose of 300krad(Si) with exposure at a high dose rate of 50 to 300rad(Si)/s; or over a total ionizing dose of 75krad(Si) with exposure at a low dose rate of $<10\text{mrad(Si)/s}$ (SEH devices only).**

Parameter	Symbol	Test Conditions	Min (Note 7)	Typ	Max (Note 7)	Unit
Output Low Voltage	$V_{E/A\ OL}$	$I_{E/A\ OUT} = 1.0\ mA$	-	0.6	1.0	V
Rising Slew Rate	SR_R		-	12	-	V/ μs
Falling Slew Rate	SR_F		-	14	-	V/ μs
Pulse Width Modulator (PWM) Comparator Section						
Ramp Bias Current	I_{RAMP}	$V_{RAMP} = 0V$	-	-0.2	-8	μA
Duty Cycle Range	DC_{MAX}	IS-1825xSRH, IS-1825xSEH	40	44	-	%
		ISL71823xSRH	80	90	-	%
E/A OUT Zero DC Threshold Voltage	$RAMP_{OFFSET}$	$V_{RAMP} = 0V$	0.81	0.93	-	V
Delay to Output Time	t_{DELAY}	$V_{E/A\ OUT} = 0V$ to 5V Step	-	600	-	ns
Soft Start Section						
Charge Current	I_{CHG}	$V_{SS} = 2.5V$, $T_A = +25^\circ C$	8	15	20	μA
		$V_{SS} = 2.5V$, $T_A = +125^\circ C$	8	-	25	μA
		$V_{SS} = 2.5V$, $T_A = -55^\circ C$	8	-	29	μA
		$V_{SS} = 2.5V$, $T_A = +25^\circ C$, Post Rad	8	-	25	μA
Discharge Current	I_{DCHG}	Soft start voltage = 2.5V	0.1	0.2	0.5	mA
Current Limit / Start Sequence / Fault Section						
Restart Threshold	V_{RS}		-	0.4	0.5	V
ILIM Bias Current	I_{BLIM}	$0.0V < V_{ILIM} < 2.0V$	-	1.4	15	μA
Current Limit Threshold	V_{LIMIT}		0.85	0.98	1.15	V
Over Current Threshold	V_{OVER}		1.05	1.18	1.26	V
Current Limit Delay	$t_{LIMIT-DEL}$		-	180	-	ns
Over Current Delay	$t_{OVER-DEL}$		-	100	-	ns
Output Section						
Output Low Saturation	V_{SATL}	$I_{OUT} = 20mA$, $T_A = +25^\circ C$	-	0.7	0.8	V
		$I_{OUT} = 20mA$, $T_A = -55^\circ C$, $+125^\circ C$	-	-	1.0	V
		$I_{OUT} = 20mA$, $T_A = +25^\circ C$, Post Rad	-	-	0.8	V
		$I_{OUT} = 200\ mA$	-	1.0	2.2	V
Output High Saturation	V_{SATH}	$I_{OUT} = 20mA$	10	11.2	-	V
		$I_{OUT} = 200\ mA$	9	10.8	-	V
Under Voltage Lockout (UVLO) Output Low Saturation Voltage	$UVLO_{OLS}$	$I_{OUT} = 20mA$	-	0.7	1.2	V
Clock Out to PWM Switching Startup Delay (See Figure 2) (IS-1825BSxH and ISL71823BSRH only)	t_{PWM}	$T_A = +25^\circ C$	200	291	380	μs
		$T_A = +125^\circ C$	400	-	660	μs
		$T_A = -55^\circ C$	100	-	278	μs
		$T_A = +25^\circ C$, Post Rad	200	-	380	μs
Under Voltage Section						
Start Threshold Voltage	V_{START}		8.2	8.6	8.8	V
Stop Threshold Voltage	V_{STOP}		7.6	8.0	8.4	V
Under Voltage Lockout Hysteresis	V_{HYS}		0.3	0.6	1.2	V

Unless otherwise noted, $V_S = V_C = V_{CC} = 12V$, $R_T = 3.65k\Omega$, $C_T = 1nF$, $T_A = +25^\circ C$. **Boldface limits apply across the operating temperature range, $-50^\circ C$ to $+125^\circ C$; over a total ionizing dose of 300krad(Si) with exposure at a high dose rate of 50 to 300rad(Si)/s; or over a total ionizing dose of 75krad(Si) with exposure at a low dose rate of $<10\text{mrad(Si)/s}$ (SEH devices only).**

Parameter	Symbol	Test Conditions	Min (Note 7)	Typ	Max (Note 7)	Unit
Supply Current Section						
Startup Current	I_{SU}	$V_S = 8.0V$	-	55	300	μA
Supply Current	I_{CC}	$V_{INV} = V_{RAMP} = V_{ILIM/SD} = 0.0V$ $V_{NON-INV} = 1.0V$	-	25	36	mA

Notes:

6. Typical values shown are not guaranteed.
7. Parameters with MIN and/or MAX limits are 100% tested at $-50^\circ C$, $+25^\circ C$, and $+125^\circ C$, unless otherwise specified.
8. V_C and V_{CC} must always be at the same potential.

2.5 Timing Diagram

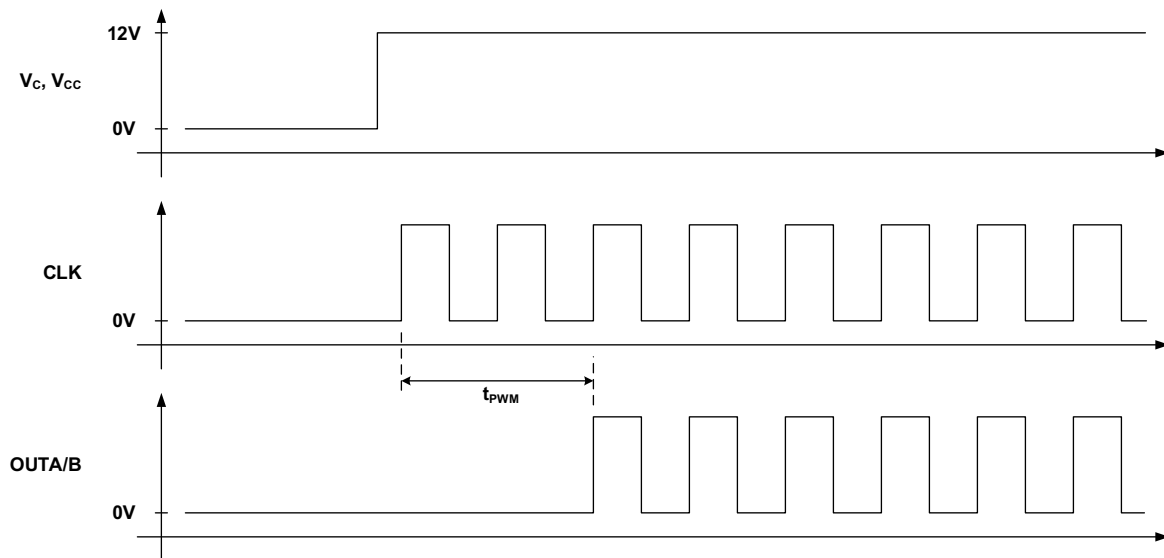

Figure 2. Timing Diagram for Clock Out to PWM Switching Delay Test (t_{PWM})

3. Typical Performance Curves

Unless otherwise noted, $V_S = V_C = V_{CC} = 12V$, $R_T = 3.65k\Omega$, $C_T = 1nF$, $T_A = +25^\circ C$

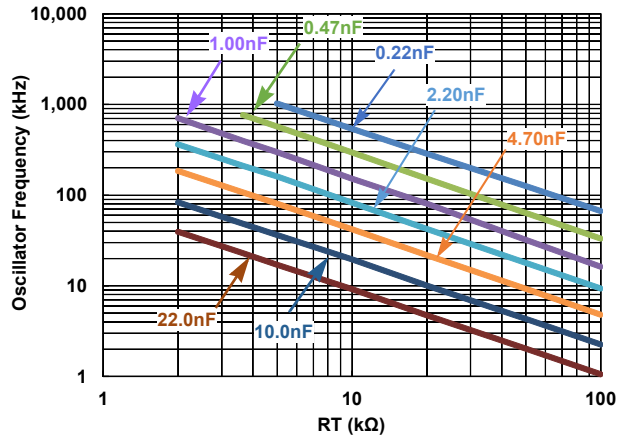

Figure 3. Oscillator Frequency vs RT and CT (+25°C)

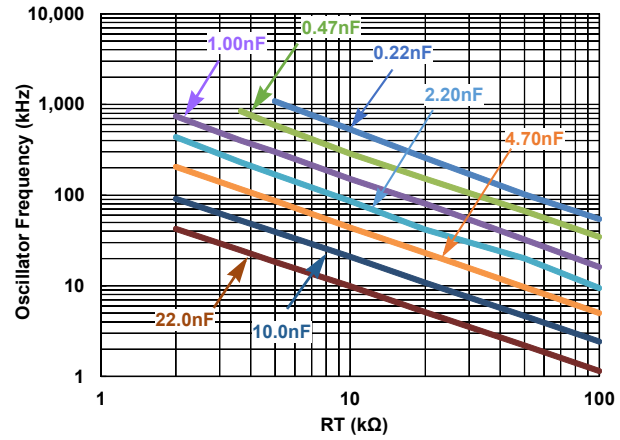

Figure 4. Oscillator Frequency vs RT and CT (+125°C)

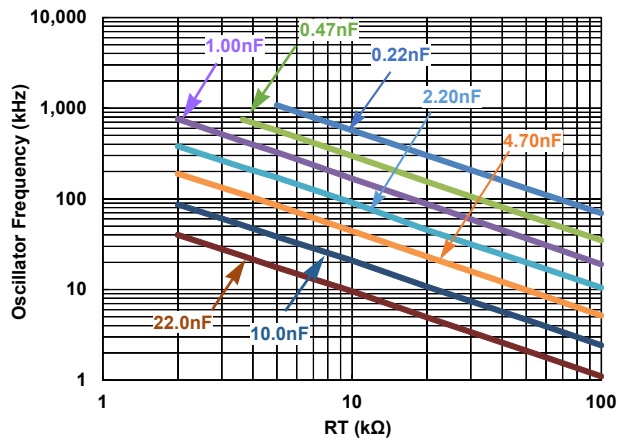

Figure 5. Oscillator Frequency vs RT and CT (-50°C)

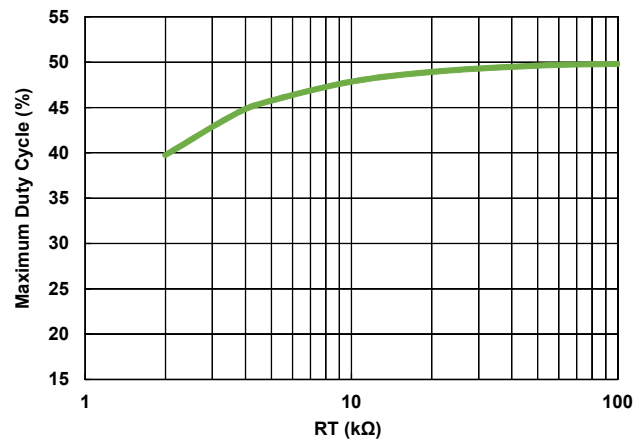

Figure 6. Maximum Duty Cycle vs RT (+25°C)

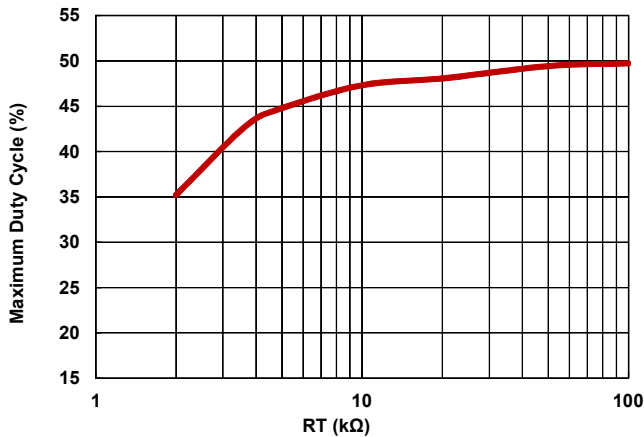

Figure 7. Maximum Duty Cycle vs RT (+125°C)

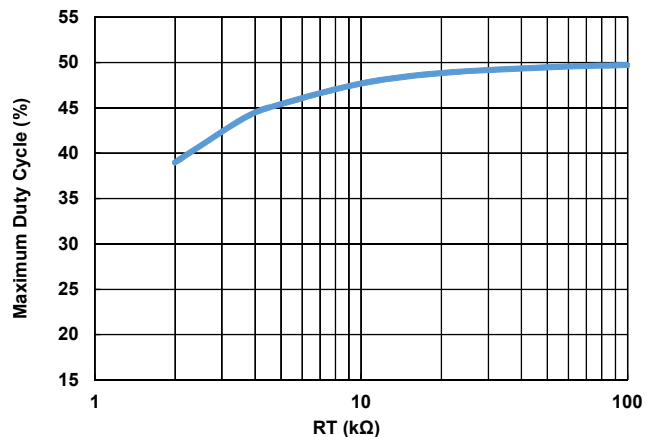

Figure 8. Maximum Duty Cycle vs RT (-50°C)

Unless otherwise noted, $V_S = V_C = V_{CC} = 12V$, $R_T = 3.65k\Omega$, $C_T = 1nF$, $T_A = +25^\circ C$ (Continued)

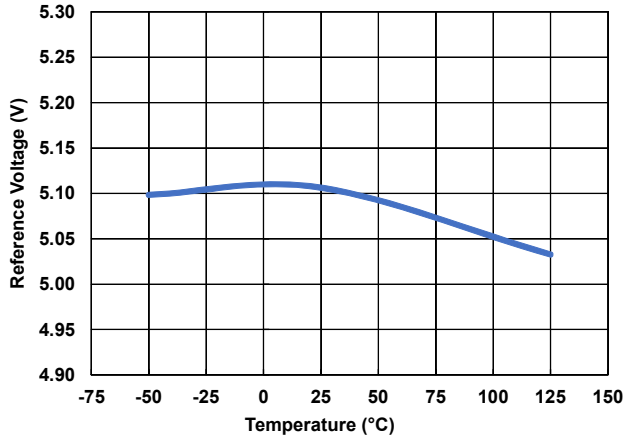

Figure 9. V_{REF} vs Temperature

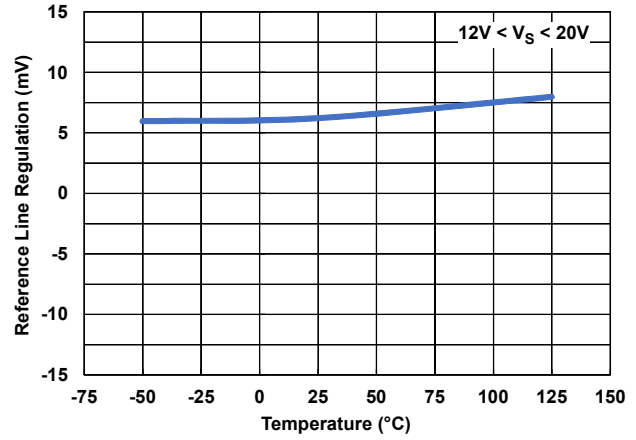

Figure 10. V_{REF} Line Regulation vs Temperature

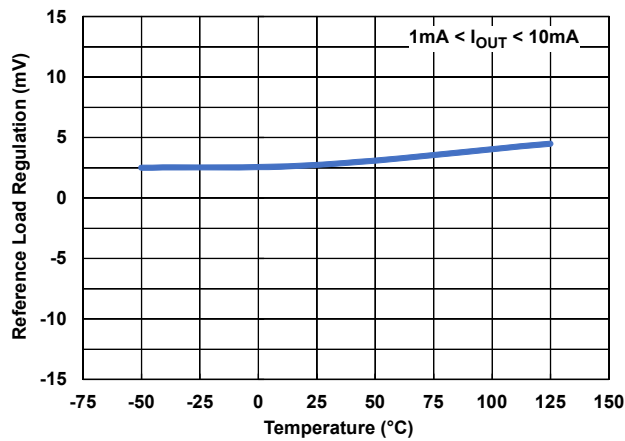

Figure 11. V_{REF} Load Regulation vs Temperature

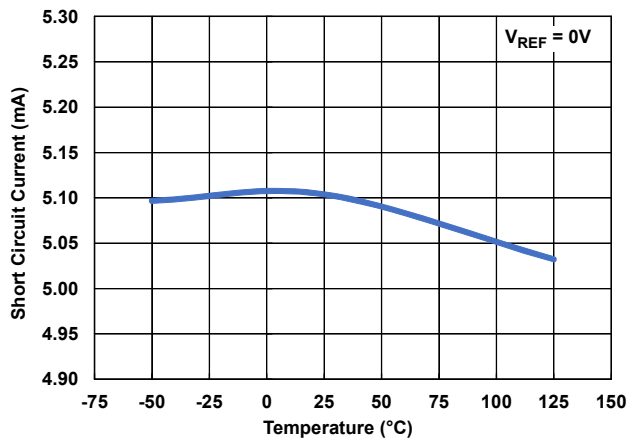

Figure 12. V_{REF} Short Circuit Current vs Temperature

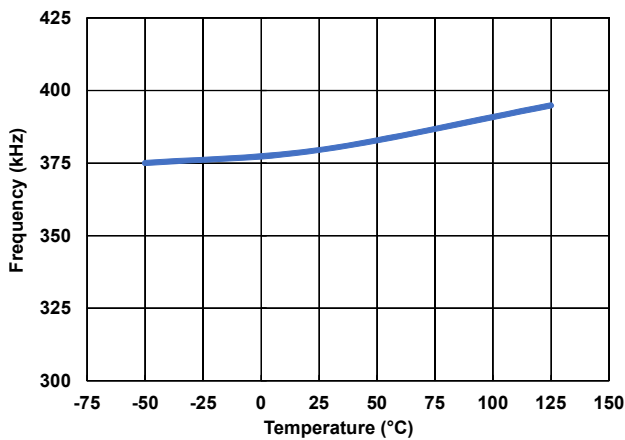

Figure 13. Oscillator Initial Accuracy vs Temperature

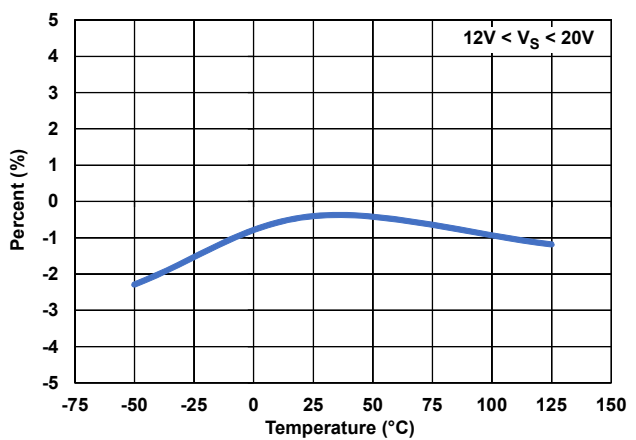

Figure 14. Oscillator Voltage Stability vs Temperature

Unless otherwise noted, $V_S = V_C = V_{CC} = 12V$, $R_T = 3.65k\Omega$, $C_T = 1nF$, $T_A = +25^\circ C$ (Continued)

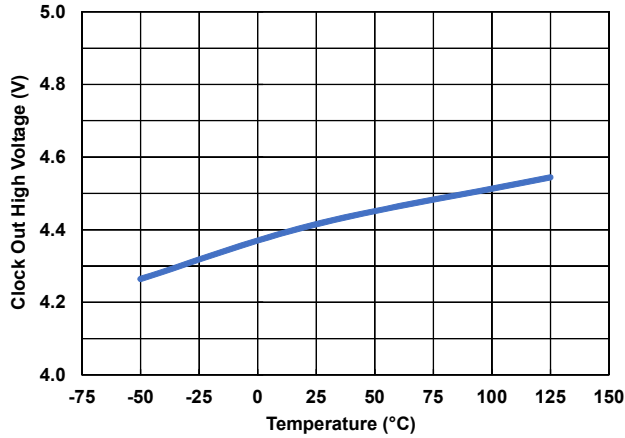

Figure 15. Oscillator V_{CLKH} vs Temperature

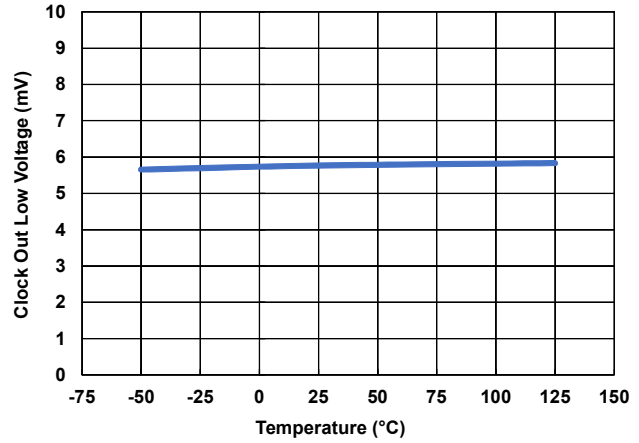

Figure 16. Oscillator V_{CLKL} vs Temperature

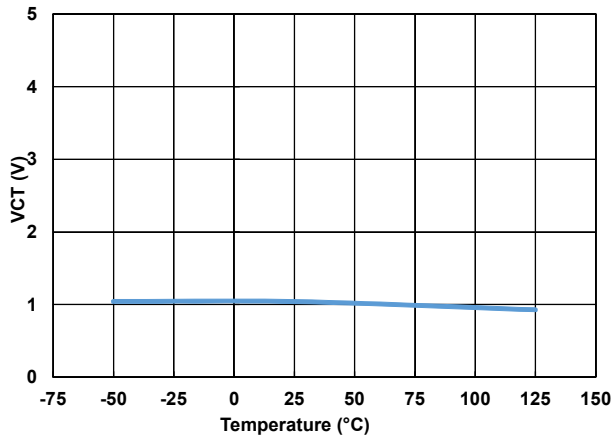

Figure 17. CT Valley Voltage vs Temperature

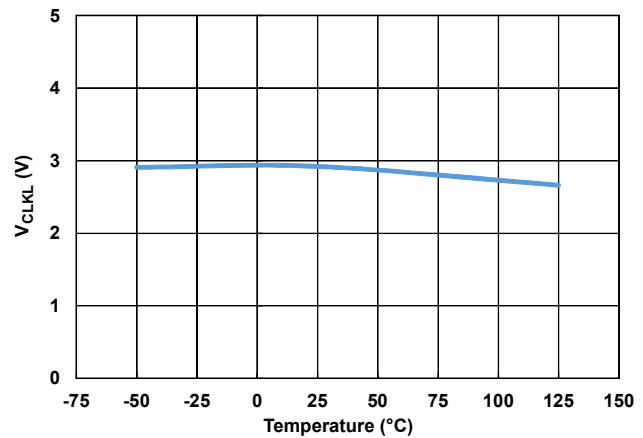

Figure 18. CT Peak Voltage vs Temperature

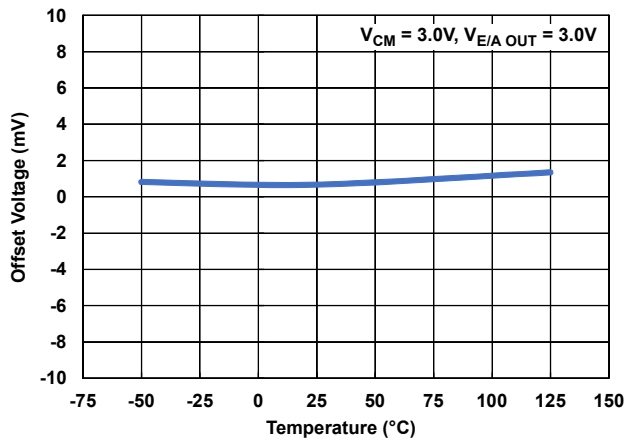

Figure 19. Error Amp V_{OS} vs Temperature

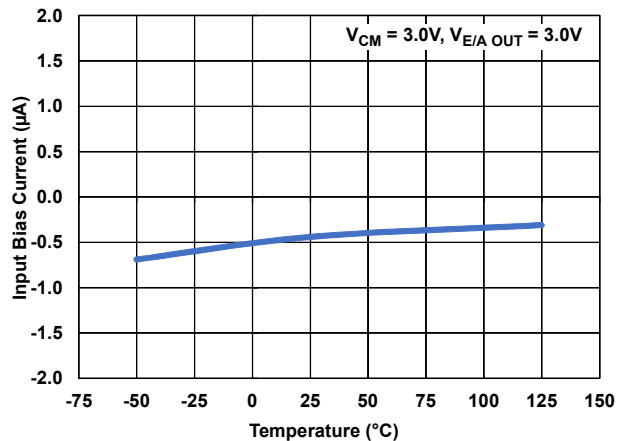

Figure 20. Error Amp I_{BIAS} vs Temperature

Unless otherwise noted, $V_S = V_C = V_{CC} = 12V$, $R_T = 3.65k\Omega$, $C_T = 1nF$, $T_A = +25^\circ C$ (Continued)

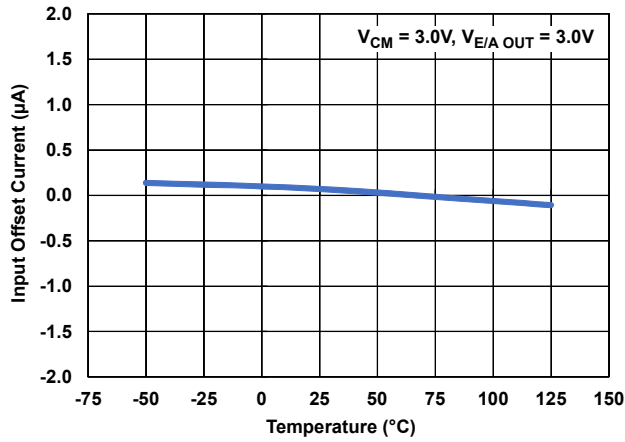

Figure 21. Error Amp I_{OS} vs Temperature

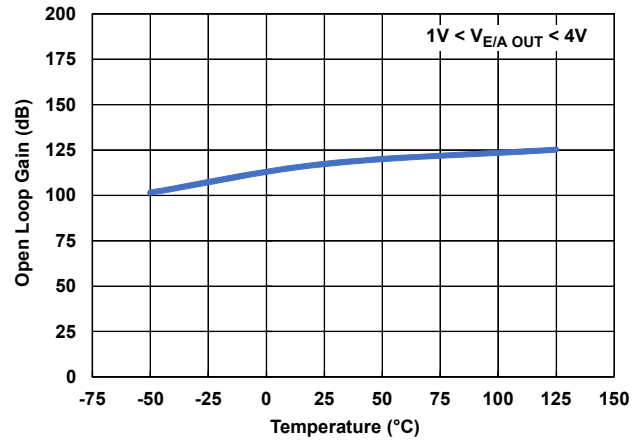

Figure 22. Error Amp A_{VOL} vs Temperature

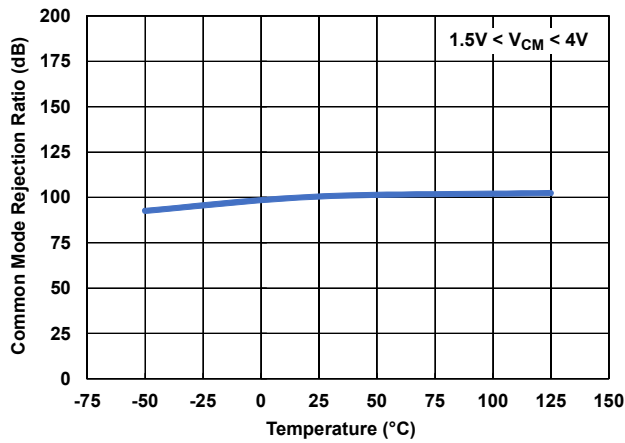

Figure 23. Error Amp CMRR vs Temperature

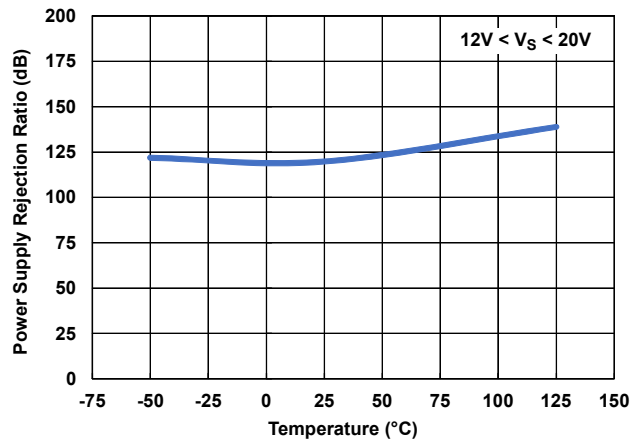

Figure 24. Error Amp PSRR vs Temperature

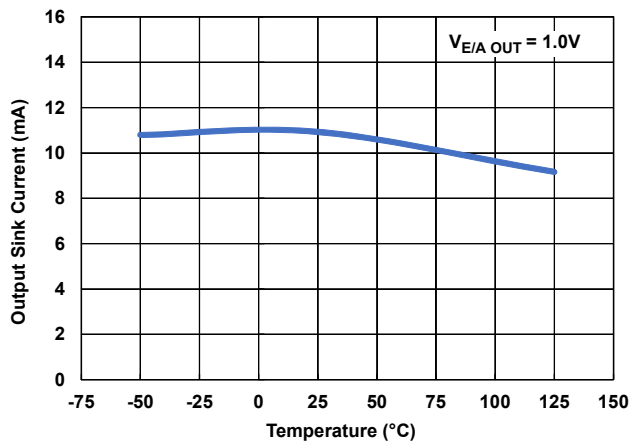

Figure 25. Error Amp I_{OL} vs Temperature

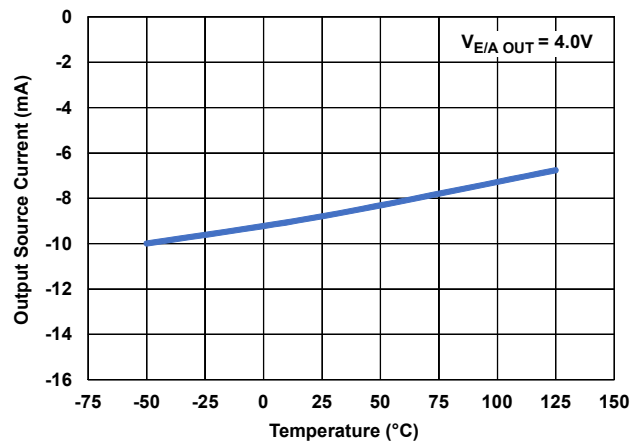

Figure 26. Error Amp I_{OH} vs Temperature

Unless otherwise noted, $V_S = V_C = V_{CC} = 12V$, $R_T = 3.65k\Omega$, $C_T = 1nF$, $T_A = +25^\circ C$ (Continued)

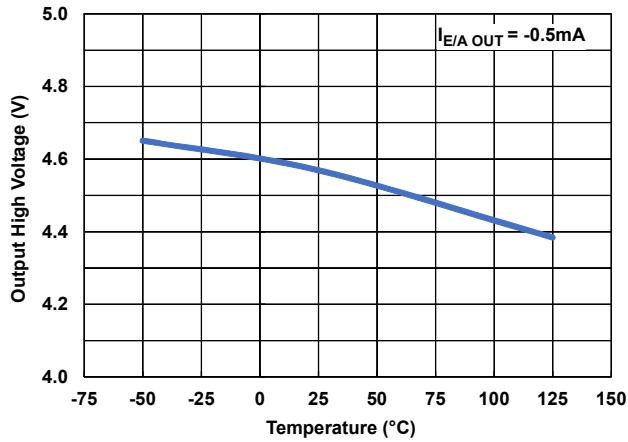

Figure 27. Error Amp V_{OH} vs Temperature

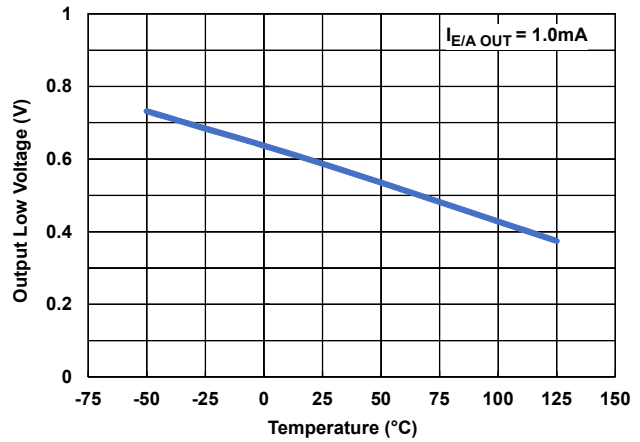

Figure 28. Error Amp V_{OL} vs Temperature

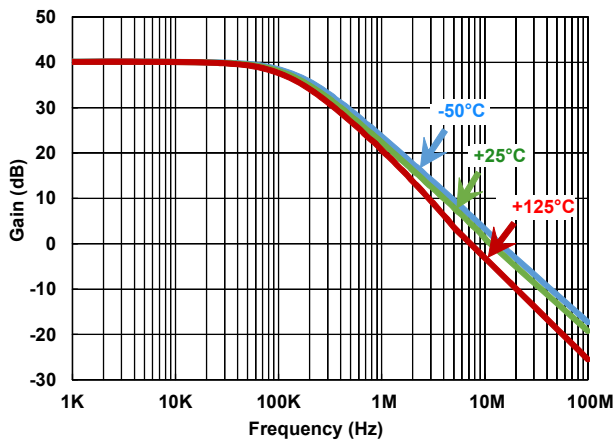

Figure 29. Error Amplifier Frequency Response

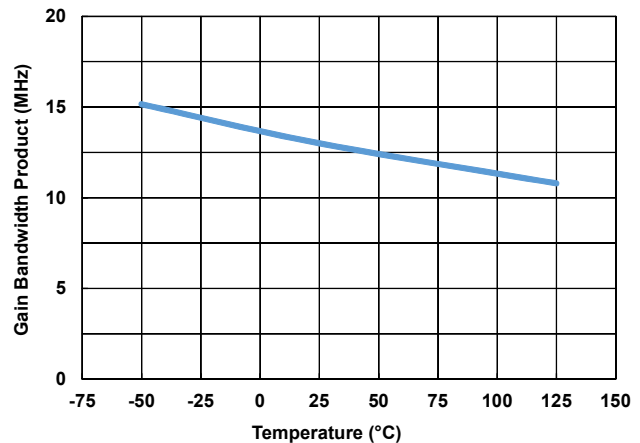

Figure 30. Error Amplifier GBWP vs Temperature

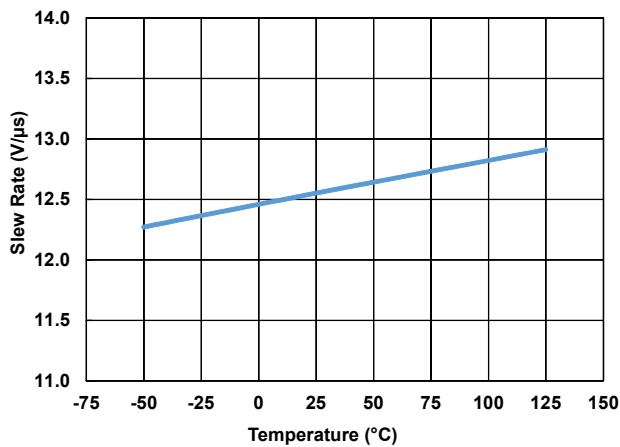

Figure 31. Error Amplifier Rising Slew Rate vs Temperature

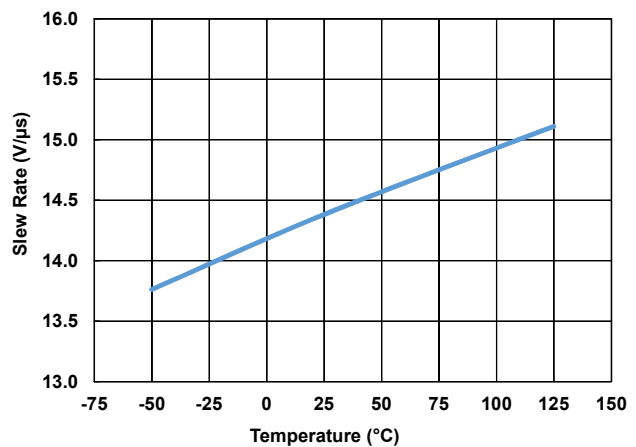

Figure 32. Error Amplifier Falling Slew Rate vs Temperature

Unless otherwise noted, $V_S = V_C = V_{CC} = 12V$, $R_T = 3.65k\Omega$, $C_T = 1nF$, $T_A = +25^\circ C$ (Continued)

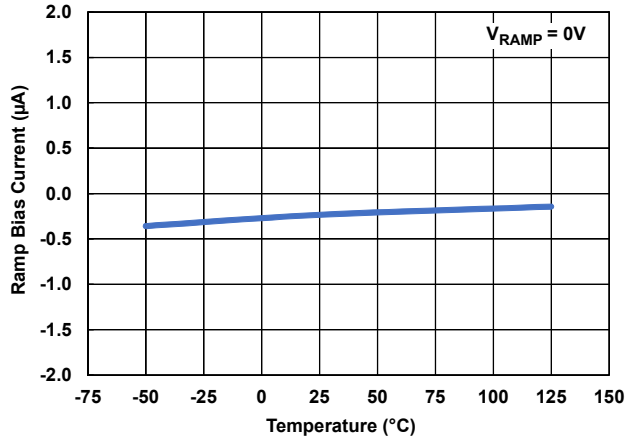

Figure 33. Ramp Bias Current vs Temperature

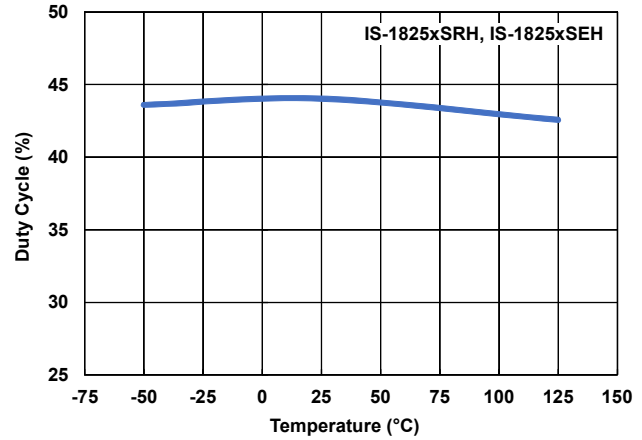

Figure 34. Maximum Duty Cycle vs Temperature

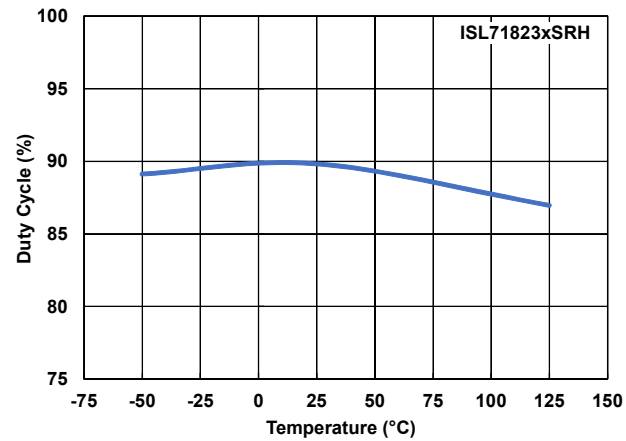

Figure 35. Maximum Duty Cycle vs Temperature

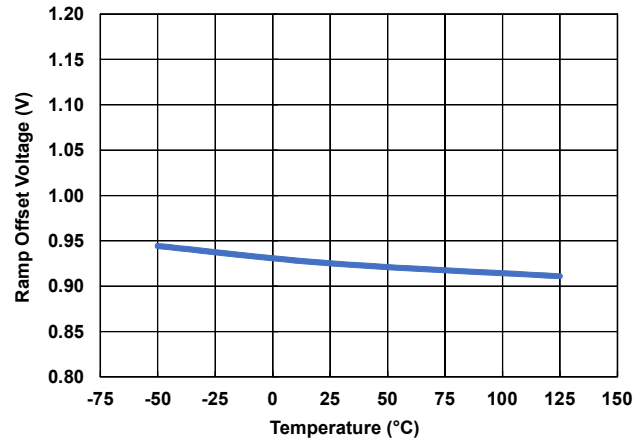

Figure 36. Ramp Offset vs Temperature

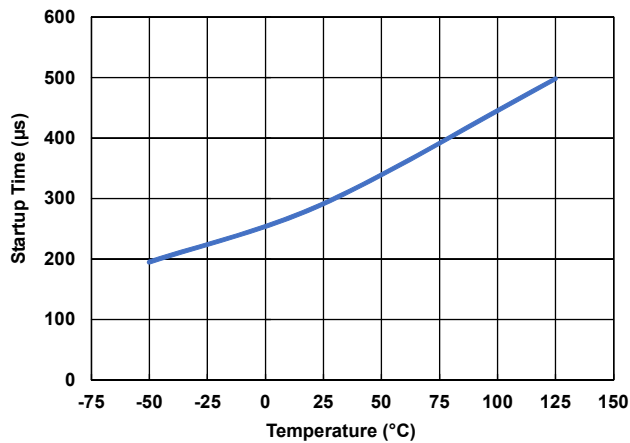

Figure 37. Clock to PWM Startup Delay vs Temperature

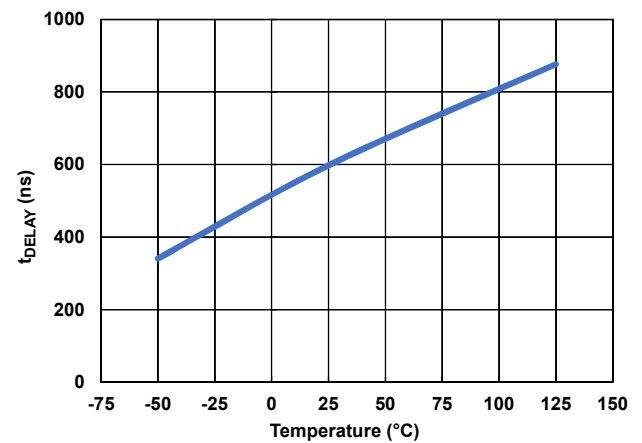

Figure 38. PWM Comparator to OUT Delay vs Temperature

Unless otherwise noted, $V_S = V_C = V_{CC} = 12V$, $R_T = 3.65k\Omega$, $C_T = 1nF$, $T_A = +25^\circ C$ (Continued)

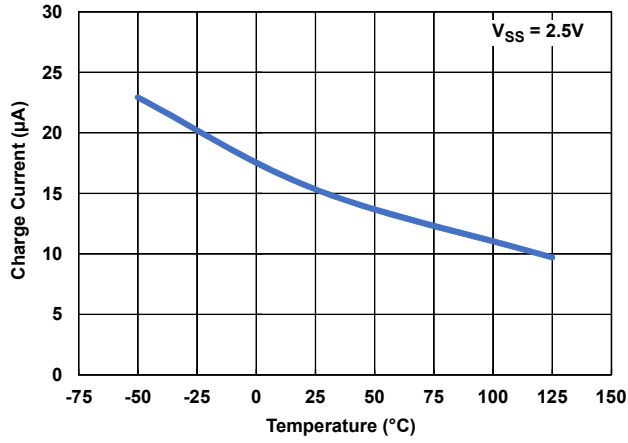

Figure 39. Soft Start Charge Current vs Temperature

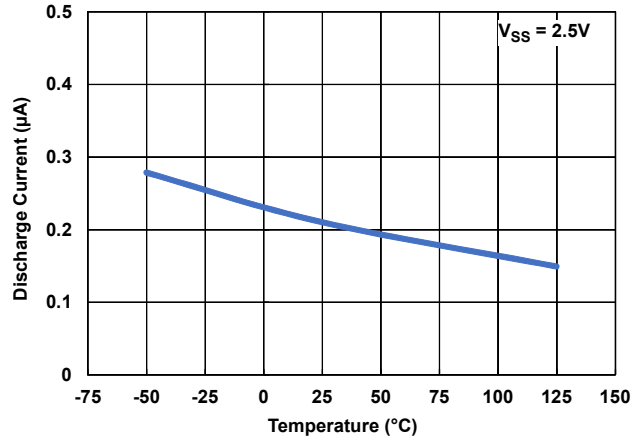

Figure 40. Soft Start Discharge Current vs Temperature

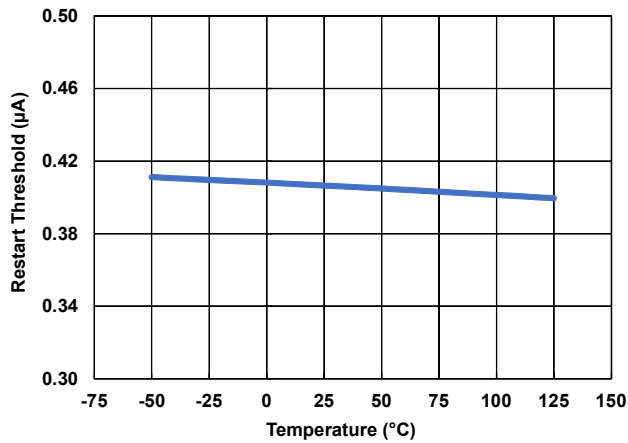

Figure 41. I_{LIM} Restart Threshold vs Temperature

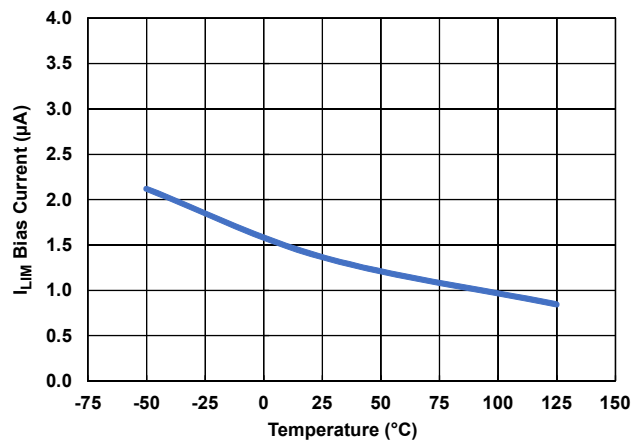

Figure 42. I_{LIM} Bias Current vs Temperature

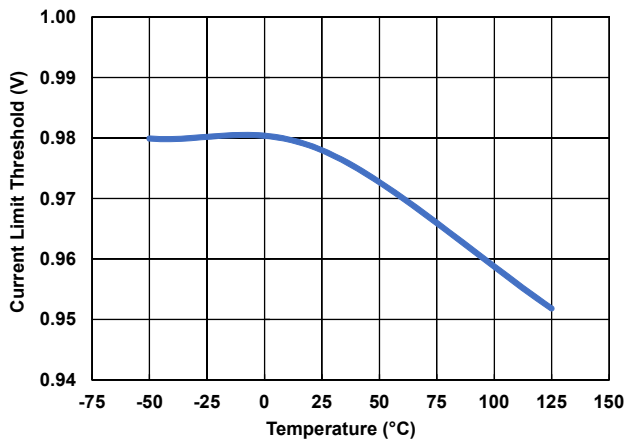

Figure 43. V_{LIMIT} vs Temperature

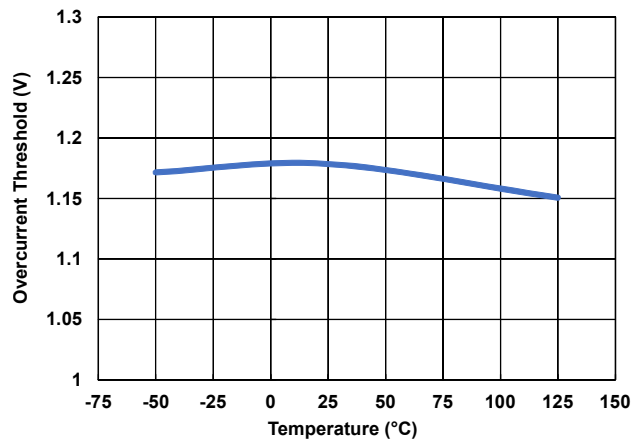

Figure 44. V_{OVER} vs Temperature

Unless otherwise noted, $V_S = V_C = V_{CC} = 12V$, $R_T = 3.65k\Omega$, $C_T = 1nF$, $T_A = +25^\circ C$ (Continued)

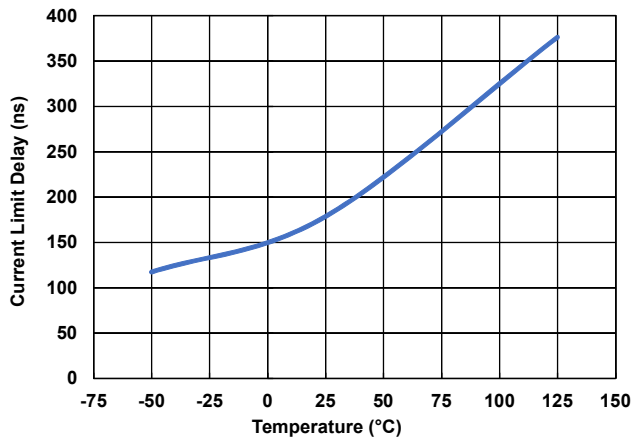

Figure 45. Current Limit Delay vs Temperature

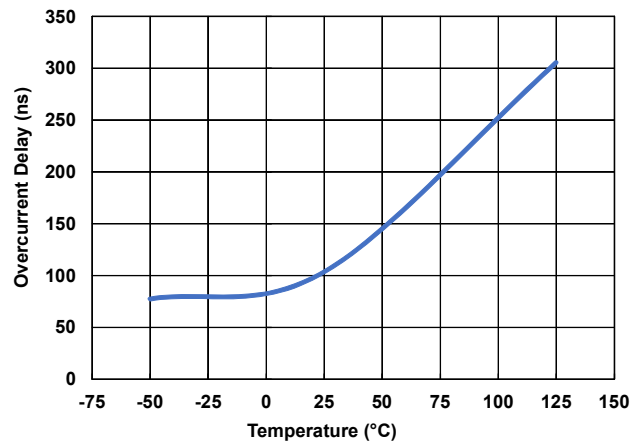

Figure 46. Overcurrent Delay vs Temperature

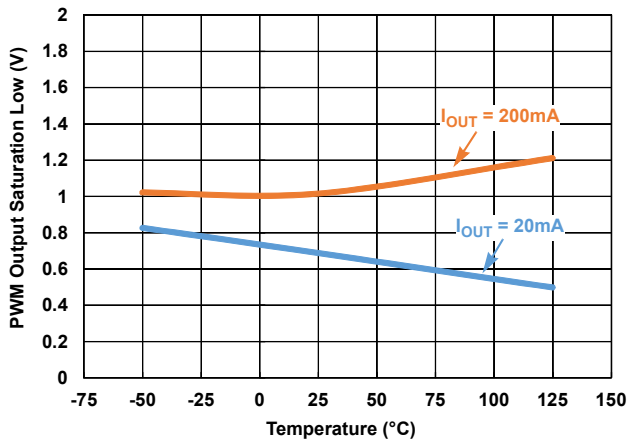

Figure 47. V_{SATL} vs Temperature

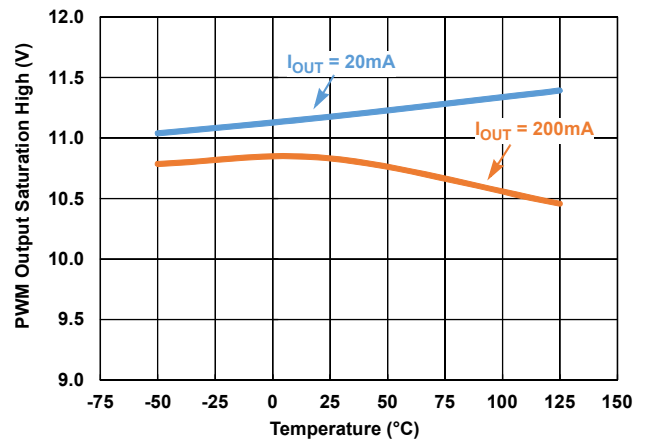

Figure 48. V_{SATH} vs Temperature

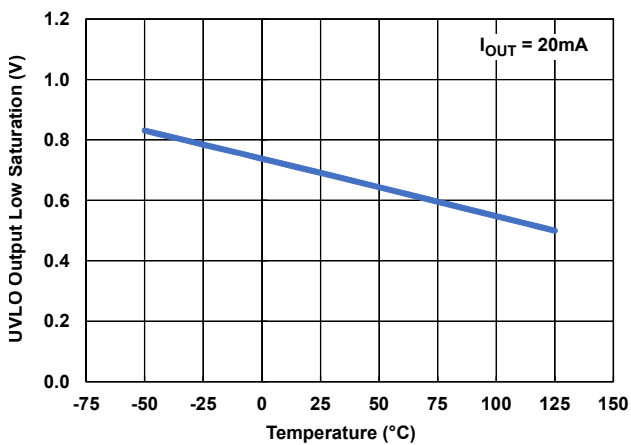

Figure 49. $UVLO_{OLS}$ vs Temperature

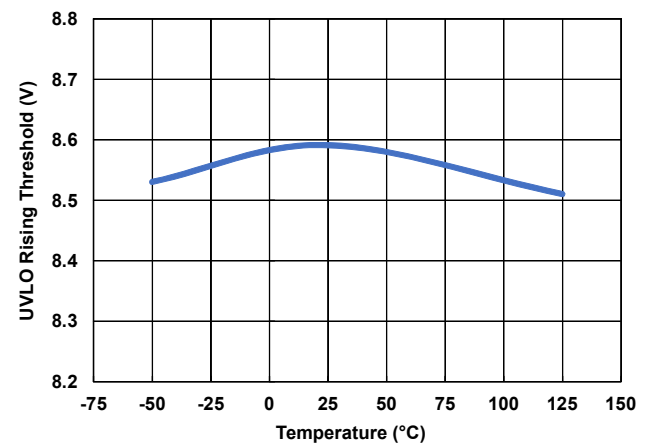

Figure 50. V_{START} vs Temperature

Unless otherwise noted, $V_S = V_C = V_{CC} = 12V$, $R_T = 3.65k\Omega$, $C_T = 1nF$, $T_A = +25^\circ C$ (Continued)

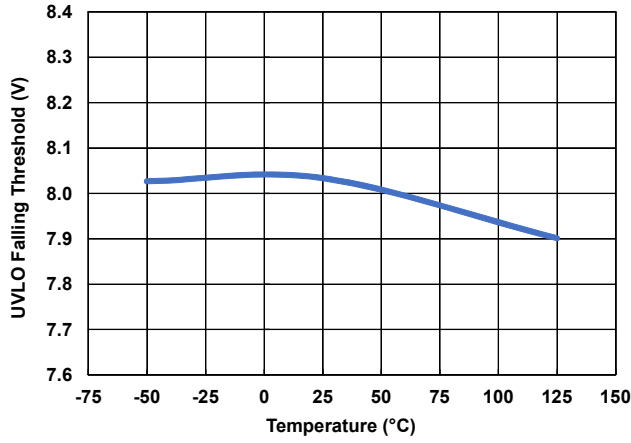

Figure 51. V_{STOP} vs Temperature

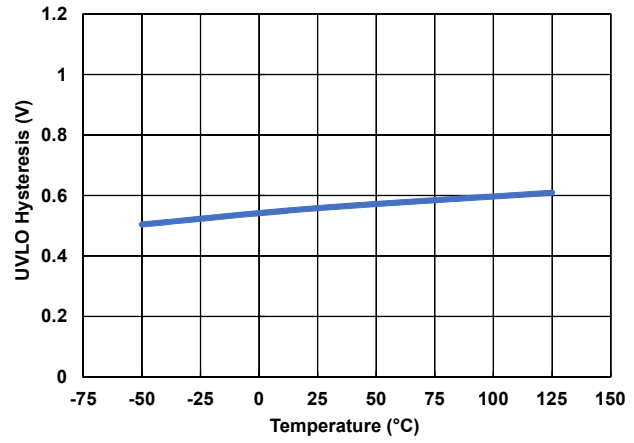

Figure 52. V_{HYS} vs Temperature

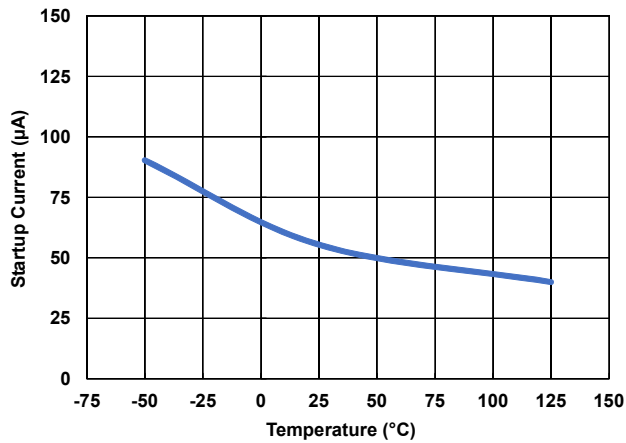

Figure 53. Startup Current vs Temperature

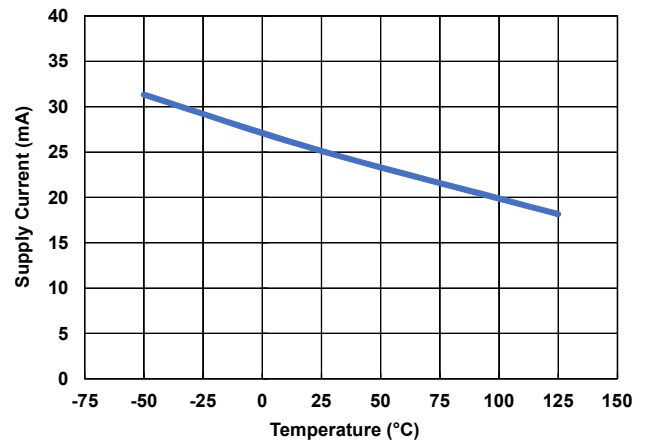

Figure 54. Supply Current vs Temperature

4. Die and Assembly Characteristics

Table 2. Die and Assembly Related Information

Die Information	
Dimensions	4310 μ m x 5840 μ m (170 mils x 230 mils) Thickness: 483 μ m \pm 25.4 μ m (19 mils \pm 1 mil)
Interface Materials	
Glassivation	Type: Phosphorus Silicon Glass (PSG) Thickness: 8.0k \AA \pm 1.0k \AA
Top Metallization	Type: AlCu (99.5%/0.5%) Thickness: 16.0k \AA \pm 2k \AA
Backside Finish	Silicon
Process	Radiation Hardened Silicon Gate, Dielectrically Isolated (DI)
Assembly Information	
Substrate Potential	Unbiased (DI)
Additional Information	
Worst Case Current Density	<2x10 ⁵ A/cm ²
Transistor Count	585

4.1 Metallization Mask Layout

IS-1825xSRH, IS-1825xSEH, ISL71823xSRH

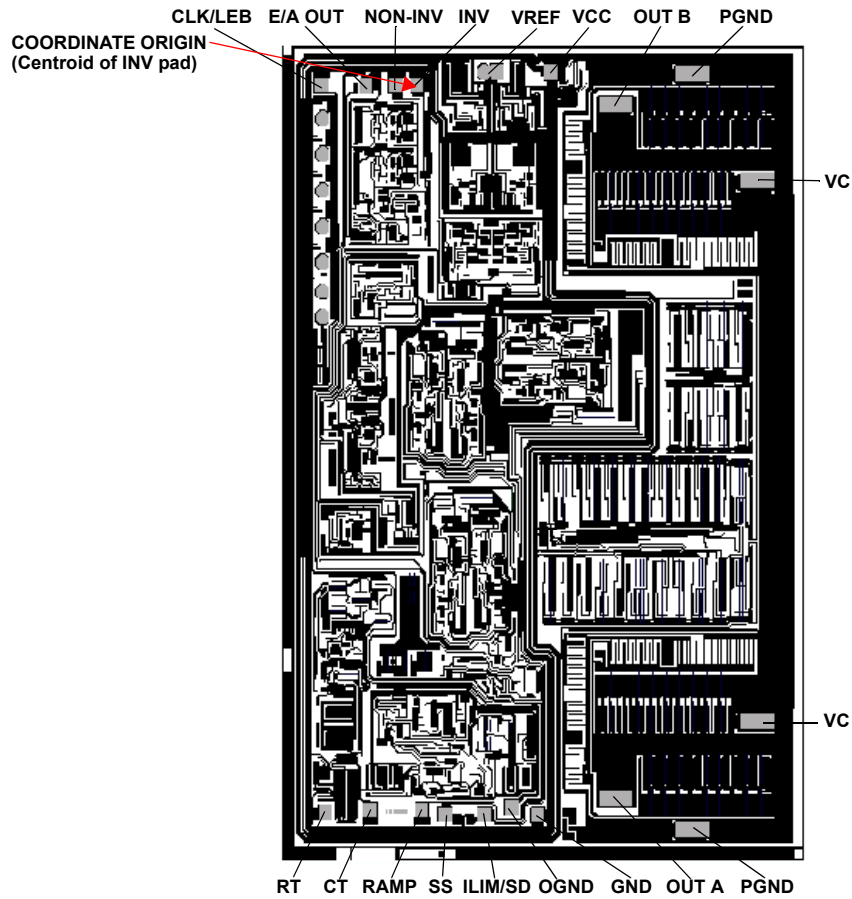

Notes:

9. Both the OGND (oscillator ground) and the GND (control circuit ground) pads must be bonded to ground. These pads are both bonded to the GND pin on the packaged devices.
10. All double-sized bond pads must be double bonded for current sharing purposes.

4.2 Bond Pad Coordinates

Table 3. Layout X-Y Coordinates (Centroid of bond pad)

Pad Number	Pad Name	X (μm)	Y (μm)	dX (μm)	dY (μm)
1	INV	0	0	110	110
2	NON-INV	-173	0	110	110
3	EA/OUT	-420	-5	110	110
4	CLK/LEB	-788	0	110	110
5	RT	-757	-5222	110	110
6	CT	-387	-5205	110	110
7	RAMP	46	-5205	110	110
8	SS	232	-5235	110	110
9	ILIM/SD	563	-5235	110	110
10	OGND	783	-5180	110	110
11	GND	1004	-5235	110	110
12	OUTA	1642	-5117.5	280	109
13	PGND	2274	-5341.5	280	109
14	VC	2812	-4570.5	280	109
15	VC	2812	-683.5	280	109
16	PGND	2274	87.5	280	109
17	OUTB	1642	-136.5	280	109
18	VCC	1107	94.5	110	110
19	VREF	622	110.5	110	110

5. Revision History

Rev.	Date	Description
7.00	Jan 15, 2018	Updated second paragraph on page 1, changed "10mrad(Si)/s" to "<10mrad(Si)/s". Added last paragraph on page 1. Added Table 1 on page 1. Added TOC. Updated Ordering information table by adding 2 new columns and Note 3 along with its cross reference. Added Pin Description section. Added Absolute Maximum Ratings, Thermal Information, and Recommended Operating Conditions sections. Added the Electrical Specifications table. Updated Figure 2. Added Typical Performance Curves. Added the Functional Block Diagram. Removed "About Intersil" section. Added new disclaimer Converted to the current document format.
6.00	Jan 5, 2017	Updated Related Literature on page 1. Removed ISL70417SEHVF from the ordering information table. Removed MSL note because it does not apply to hermetic packages. Updated Metallization Mask Layout. Updated About Intersil section.
5.00	Apr 23, 2013	Removed Part number IS-1825ASEH and added part numbers IS-1825BSEH, IS-1825BSRH, and ISL71823BSRH to ordering information table on page 2. SMD numbers in Ordering Information table corrected. Added timing diagram for CLK to OUT delay tPWM.
4.00	Apr 5, 2012	Updated to new Intersil template. Added Part IS-1825ASEH to Title and ordering information. Changed DSCC to DLA. Added typical oscillator performance curves. Updated ordering information by adding package, package drawing number, and sample parts.
3.00	Feb 19, 2008	Added ISL71823ASRH which is a metal option of the IS-1825ASRH.
2.00	Jun 14, 2005	Changed "u" to "µ" on pg 1 Features.
1.00	Jun 14, 2005	Removed "Trimmed Oscillator Discharge Current" from the Features section of both datasheets because the oscillator is not trimmed. Cosmetic edit only.
0.00	Jun 21, 2002	Initial release

6. Package Outline Drawings

For the most recent package outline drawing, see [K20.A](#).

6.1 Ceramic Metal Seal Flatpack Packages (Flatpack)

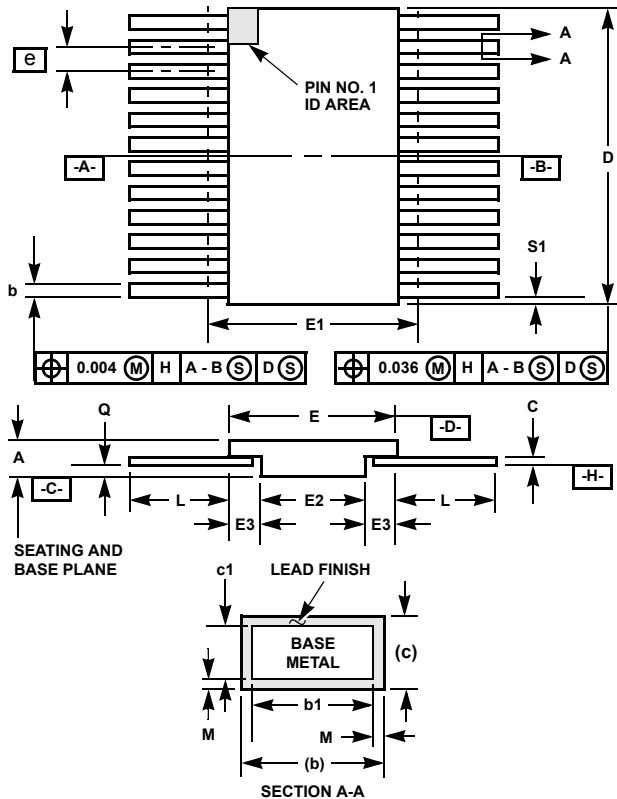

K20.A MIL-STD-1835 CDFP4-F20 (F-9A, CONFIGURATION B)
20 LEAD CERAMIC METAL SEAL FLATPACK PACKAGE

SYMBOL	INCHES		MILLIMETERS		NOTES
	MIN	MAX	MIN	MAX	
A	0.045	0.115	1.14	2.92	-
b	0.015	0.022	0.38	0.56	-
b1	0.015	0.019	0.38	0.48	-
c	0.004	0.009	0.10	0.23	-
c1	0.004	0.006	0.10	0.15	-
D	-	0.540	-	13.72	3
E	0.245	0.300	6.22	7.62	-
E1	-	0.330	-	8.38	3
E2	0.130	-	3.30	-	-
E3	0.030	-	0.76	-	7
e	0.050 BSC		1.27 BSC		-
k	0.008	0.015	0.20	0.38	2
L	0.250	0.370	6.35	9.40	-
Q	0.026	0.045	0.66	1.14	8
S1	0.00	-	0.00	-	6
M	-	0.0015	-	0.04	-
N	20		20		-

Rev. 0 5/18/94

Notes:

1. Index area: A notch or a pin one identification mark shall be located adjacent to pin one and shall be located within the shaded area shown. The manufacturer's identification shall not be used as a pin one identification mark. Alternately, a tab (dimension k) may be used to identify pin one.
2. If a pin one identification mark is used in addition to a tab, the limits of dimension k do not apply.
3. This dimension allows for off-center lid, meniscus, and glass overrun.
4. Dimensions b1 and c1 apply to lead base metal only. Dimension M applies to lead plating and finish thickness. The maximum limits of lead dimensions b and c or M shall be measured at the centroid of the finished lead surfaces, when solder dip or tin plate lead finish is applied.
5. N is the maximum number of terminal positions.
6. Measure dimension S1 at all four corners.
7. For bottom-brazed lead packages, no organic or polymeric materials shall be molded to the bottom of the package to cover the leads.
8. Dimension Q shall be measured at the point of exit (beyond the meniscus) of the lead from the body. Dimension Q minimum shall be reduced by 0.0015 inch (0.038mm) maximum when solder dip lead finish is applied.
9. Dimensioning and tolerancing per ANSI Y14.5M - 1982.
10. Controlling dimension: INCH.

6.2 Ceramic Dual-In-Line Metal Seal Packages (SBDIP)

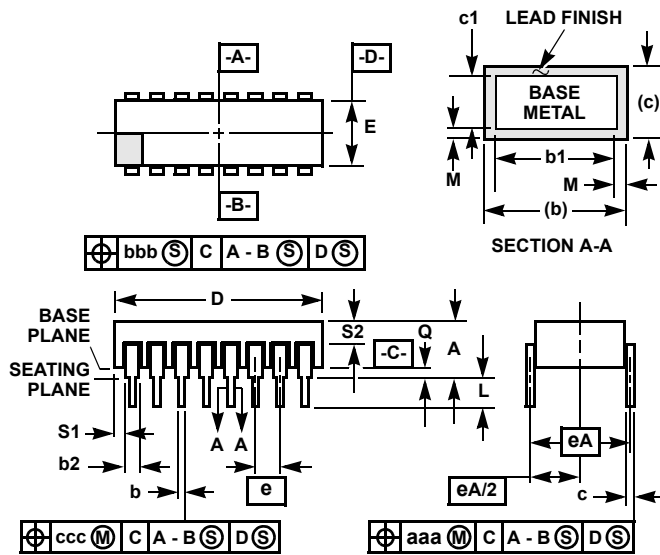

D16.3 MIL-STD-1835 CDIP2-T16 (D-2, CONFIGURATION C)
16 LEAD CERAMIC DUAL-IN-LINE METAL SEAL PACKAGE

SYMBOL	INCHES		MILLIMETERS		NOTES
	MIN	MAX	MIN	MAX	
A	-	0.200	-	5.08	-
b	0.014	0.026	0.36	0.66	2
b1	0.014	0.023	0.36	0.58	3
b2	0.045	0.065	1.14	1.65	-
b3	0.023	0.045	0.58	1.14	4
c	0.008	0.018	0.20	0.46	2
c1	0.008	0.015	0.20	0.38	3
D	-	0.840	-	21.34	-
E	0.220	0.310	5.59	7.87	-
e	0.100 BSC		2.54 BSC		-
eA	0.300 BSC		7.62 BSC		-
eA/2	0.150 BSC		3.81 BSC		-
L	0.125	0.200	3.18	5.08	-
Q	0.015	0.060	0.38	1.52	5
S1	0.005	-	0.13	-	6
S2	0.005	-	0.13	-	7
α	90°	105°	90°	105°	-
aaa	-	0.015	-	0.38	-
bbb	-	0.030	-	0.76	-
ccc	-	0.010	-	0.25	-
M	-	0.0015	-	0.038	2
N	16		16		8

Notes:

- Index area: A notch or a pin one identification mark shall be located adjacent to pin one and shall be located within the shaded area shown. The manufacturer's identification shall not be used as a pin one identification mark.
- The maximum limits of lead dimensions b and c or M shall be measured at the centroid of the finished lead surfaces, when solder dip or tin plate lead finish is applied.
- Dimensions b1 and c1 apply to lead base metal only. Dimension M applies to lead plating and finish thickness.
- Corner leads (1, N, N/2, and N/2+1) may be configured with a partial lead paddle. For this configuration dimension b3 replaces dimension b2.
- Dimension Q shall be measured from the seating plane to the base plane.
- Measure dimension S1 at all four corners.
- Measure dimension S2 from the top of the ceramic body to the nearest metallization or lead.
- N is the maximum number of terminal positions.
- Braze fillets shall be concave.
- Dimensioning and tolerancing per ANSI Y14.5M - 1982.
- Controlling dimension: INCH.

Rev. 0 4/94

For the most recent package outline drawing, see [D16.3](#).

Notice

1. Descriptions of circuits, software and other related information in this document are provided only to illustrate the operation of semiconductor products and application examples. You are fully responsible for the incorporation or any other use of the circuits, software, and information in the design of your product or system. Renesas Electronics disclaims any and all liability for any losses and damages incurred by you or third parties arising from the use of these circuits, software, or information.
2. Renesas Electronics hereby expressly disclaims any warranties against and liability for infringement or any other claims involving patents, copyrights, or other intellectual property rights of third parties, by or arising from the use of Renesas Electronics products or technical information described in this document, including but not limited to, the product data, drawings, charts, programs, algorithms, and application examples.
3. No license, express, implied or otherwise, is granted hereby under any patents, copyrights or other intellectual property rights of Renesas Electronics or others.
4. You shall not alter, modify, copy, or reverse engineer any Renesas Electronics product, whether in whole or in part. Renesas Electronics disclaims any and all liability for any losses or damages incurred by you or third parties arising from such alteration, modification, copying or reverse engineering.
5. Renesas Electronics products are classified according to the following two quality grades: "Standard" and "High Quality". The intended applications for each Renesas Electronics product depends on the product's quality grade, as indicated below.
"Standard": Computers; office equipment; communications equipment; test and measurement equipment; audio and visual equipment; home electronic appliances; machine tools; personal electronic equipment; industrial robots; etc.
"High Quality": Transportation equipment (automobiles, trains, ships, etc.); traffic control (traffic lights); large-scale communication equipment; key financial terminal systems; safety control equipment; etc.
Unless expressly designated as a high reliability product or a product for harsh environments in a Renesas Electronics data sheet or other Renesas Electronics document, Renesas Electronics products are not intended or authorized for use in products or systems that may pose a direct threat to human life or bodily injury (artificial life support devices or systems; surgical implantations; etc.), or may cause serious property damage (space system; undersea repeaters; nuclear power control systems; aircraft control systems; key plant systems; military equipment; etc.). Renesas Electronics disclaims any and all liability for any damages or losses incurred by you or any third parties arising from the use of any Renesas Electronics product that is inconsistent with any Renesas Electronics data sheet, user's manual or other Renesas Electronics document.
6. When using Renesas Electronics products, refer to the latest product information (data sheets, user's manuals, application notes, "General Notes for Handling and Using Semiconductor Devices" in the reliability handbook, etc.), and ensure that usage conditions are within the ranges specified by Renesas Electronics with respect to maximum ratings, operating power supply voltage range, heat dissipation characteristics, installation, etc. Renesas Electronics disclaims any and all liability for any malfunctions, failure or accident arising out of the use of Renesas Electronics products outside of such specified ranges.
7. Although Renesas Electronics endeavors to improve the quality and reliability of Renesas Electronics products, semiconductor products have specific characteristics, such as the occurrence of failure at a certain rate and malfunctions under certain use conditions. Unless designated as a high reliability product or a product for harsh environments in a Renesas Electronics data sheet or other Renesas Electronics document, Renesas Electronics products are not subject to radiation resistance design. You are responsible for implementing safety measures to guard against the possibility of bodily injury, injury or damage caused by fire, and/or danger to the public in the event of a failure or malfunction of Renesas Electronics products, such as safety design for hardware and software, including but not limited to redundancy, fire control and malfunction prevention, appropriate treatment for aging degradation or any other appropriate measures. Because the evaluation of microcomputer software alone is very difficult and impractical, you are responsible for evaluating the safety of the final products or systems manufactured by you.
8. Please contact a Renesas Electronics sales office for details as to environmental matters such as the environmental compatibility of each Renesas Electronics product. You are responsible for carefully and sufficiently investigating applicable laws and regulations that regulate the inclusion or use of controlled substances, including without limitation, the EU RoHS Directive, and using Renesas Electronics products in compliance with all these applicable laws and regulations. Renesas Electronics disclaims any and all liability for damages or losses occurring as a result of your noncompliance with applicable laws and regulations.
9. Renesas Electronics products and technologies shall not be used for or incorporated into any products or systems whose manufacture, use, or sale is prohibited under any applicable domestic or foreign laws or regulations. You shall comply with any applicable export control laws and regulations promulgated and administered by the governments of any countries asserting jurisdiction over the parties or transactions.
10. It is the responsibility of the buyer or distributor of Renesas Electronics products, or any other party who distributes, disposes of, or otherwise sells or transfers the product to a third party, to notify such third party in advance of the contents and conditions set forth in this document.
11. This document shall not be reprinted, reproduced or duplicated in any form, in whole or in part, without prior written consent of Renesas Electronics.
12. Please contact a Renesas Electronics sales office if you have any questions regarding the information contained in this document or Renesas Electronics products.
(Note 1) "Renesas Electronics" as used in this document means Renesas Electronics Corporation and also includes its directly or indirectly controlled subsidiaries.
(Note 2) "Renesas Electronics product(s)" means any product developed or manufactured by or for Renesas Electronics.

(Rev.4.0-1 November 2017)



SALES OFFICES

Renesas Electronics Corporation

<http://www.renesas.com>

Refer to "<http://www.renesas.com/>" for the latest and detailed information.

Renesas Electronics America Inc.

1001 Murphy Ranch Road, Milpitas, CA 95035, U.S.A.
Tel: +1-408-432-8888, Fax: +1-408-434-5351

Renesas Electronics Canada Limited

9251 Yonge Street, Suite 8309 Richmond Hill, Ontario Canada L4C 9T3
Tel: +1-905-237-2004

Renesas Electronics Europe Limited

Dukes Meadow, Millboard Road, Bourne End, Buckinghamshire, SL8 5FH, U.K
Tel: +44-1628-651-700, Fax: +44-1628-651-804

Renesas Electronics Europe GmbH

Arcadiastrasse 10, 40472 Düsseldorf, Germany
Tel: +49-211-6503-0, Fax: +49-211-6503-1327

Renesas Electronics (China) Co., Ltd.

Room 1709 Quantum Plaza, No.27 ZhichunLu, Haidian District, Beijing, 100191 P. R. China
Tel: +86-10-8235-1155, Fax: +86-10-8235-7679

Renesas Electronics (Shanghai) Co., Ltd.

Unit 301, Tower A, Central Towers, 555 Langao Road, Putuo District, Shanghai, 200333 P. R. China
Tel: +86-21-2226-0888, Fax: +86-21-2226-0999

Renesas Electronics Hong Kong Limited

Unit 1601-1611, 16/F., Tower 2, Grand Century Place, 193 Prince Edward Road West, Mongkok, Kowloon, Hong Kong
Tel: +852-2265-6688, Fax: +852 2886-9022

Renesas Electronics Taiwan Co., Ltd.

13F, No. 363, Fu Shing North Road, Taipei 10543, Taiwan
Tel: +886-2-8175-9600, Fax: +886 2-8175-9670

Renesas Electronics Singapore Pte. Ltd.

80 Bendemeer Road, Unit #06-02 Hyflux Innovation Centre, Singapore 339949
Tel: +65-6213-0200, Fax: +65-6213-0300

Renesas Electronics Malaysia Sdn.Bhd.

Unit 1207, Block B, Menara Amcorp, Amcorp Trade Centre, No. 18, Jln Persiaran Barat, 46050 Petaling Jaya, Selangor Darul Ehsan, Malaysia
Tel: +60-3-7955-9390, Fax: +60-3-7955-9510

Renesas Electronics India Pvt. Ltd.

No.777C, 100 Feet Road, HAL 2nd Stage, Indiranagar, Bangalore 560 038, India
Tel: +91-80-67208700, Fax: +91-80-67208777

Renesas Electronics Korea Co., Ltd.

17F, KAMCO Yangjae Tower, 262, Gangnam-daero, Gangnam-gu, Seoul, 06265 Korea
Tel: +82-2-558-3737, Fax: +82-2-558-5338