

# Application Note

## Smart Lock Motor Driver with Battery Discharge Compensation

### AN-CM-298

#### Abstract

*This application note describes the HVPAK IC design configuration as an integrated smart lock motor driver with dynamic overcurrent detection that accommodates varying supply voltages and loads. The application note comes complete with a design file which can be found in the Reference section.*

---

---

## Smart Lock Motor Driver with Battery Discharge Compensation

### Contents

<b>Abstract</b> .....	<b>1</b>
<b>Contents</b> .....	<b>2</b>
<b>Figures</b> .....	<b>2</b>
<b>Tables</b> .....	<b>2</b>
<b>1 Terms and Definitions</b> .....	<b>3</b>
<b>2 References</b> .....	<b>3</b>
<b>3 Introduction</b> .....	<b>4</b>
<b>4 Construction and Operation Principle</b> .....	<b>5</b>
4.1 Operation Principle.....	5
4.2 HVPAK Design.....	6
4.3 Application Circuit .....	8
4.4 Motor Test .....	9
<b>5 Design Operation Waveforms</b> .....	<b>11</b>
5.1 Normal Operation.....	11
5.2 Stalled Motor at the Start .....	12
<b>6 Conclusion</b> .....	<b>13</b>
<b>Revision History</b> .....	<b>14</b>

### Figures

Figure 1: Motor Current Waveform.....	4
Figure 2: Motor Current Waveform with Compensation.....	4
Figure 3: Design Operations.....	5
Figure 4: HVPAK Design.....	6
Figure 5: RegFile Data .....	6
Figure 6: RegFile Usage.....	7
Figure 7: Motor Off Operation .....	7
Figure 8: Typical Application Circuit.....	8
Figure 9: Motor Starting Current Waveform, Power Supply 3.6 V .....	9
Figure 10: Motor No-Load Current, Power Supply 3.6 V .....	9
Figure 11: Motor Starting Current Waveform, Power Supply 6.0 V .....	10
Figure 12: Motor No-Load Current, Power Supply 6.0 V .....	10
Figure 13: No-Load Motor, Power Supply 6.0 V .....	11
Figure 14: No-Load Motor, Power Supply 3.6 V .....	11
Figure 15: Loaded Motor, Power Supply 3.0 V .....	12
Figure 16: Stalled Motor, Power Supply 3.6 V – 6.0 V.....	12

### Tables

Table 1: Motor Parameters.....	9
--------------------------------	---

---

## Smart Lock Motor Driver with Battery Discharge Compensation

### 1 Terms and Definitions

DC	Direct current
PWM	Pulse width modulation
CMP	Comparator
CCMP	Current comparator
MCU	Microcontroller unit
HV	High voltage
GPO	General purpose output

### 2 References

For related documents and software, please visit:

[GreenPAK™ Programmable Mixed-Signal Products | Renesas](#)

Download our free [GreenPAK Designer](#) software [1] to open the .gp files [2] and view the proposed circuit design. Use the [GreenPAK development tools](#) [3] to freeze the design into your own customized IC in a matter of minutes. Find out more in complete library of application notes [4] featuring design examples as well as explanations of features and blocks within the GreenPAK IC.

- [1] [GreenPAK Designer Software](#), Software Download and User Guide
- [2] [AN-CM-298 Smart Lock Motor Driver with Battery Discharge Compensation.hvp](#), [HVPAK Design File](#)
- [3] [GreenPAK Development Tools](#), [GreenPAK Development Tools Webpage](#)
- [4] [GreenPAK Application Notes](#), [GreenPAK Application Notes Webpage](#)

Author: Petro Zhuk

## Smart Lock Motor Driver with Battery Discharge Compensation

### 3 Introduction

Most smart locks use batteries for their power supply, and the battery life is typically 6 months to 1 year. This time depends on the wireless technology used (Wi-Fi, Bluetooth, ZigBee), and how often the door is locked and unlocked. In many cases the motor is powered by four AA batteries, and that is also used in this design example.

Smart lock manufacturers use varying mechanisms for detecting the completion of the deadbolt opening/closing: limit switches, accelerometer fixed on the shaft, hall sensor and magnets fixed on the gear, etc. All these require the associated external components along with the motor driver IC.

One of the deadbolt position detecting schemes is measuring the motor current, and turning off the motor when the deadbolt locks while the motor current increases to a defined threshold, see [Figure 1](#). This method doesn't require special extra components. However, the threshold must be set relative to a specific supply voltage, usually fully charged batteries.

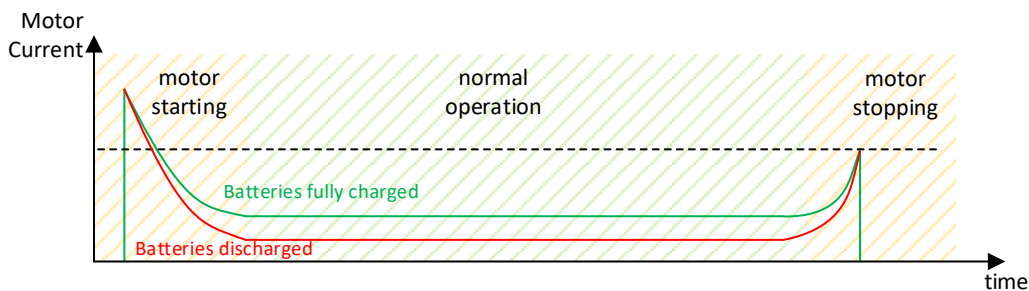

**Figure 1: Motor Current Waveform**

An improvement to the design is to measure the RMS current per motor and set different current levels to compensate for different battery voltages, see [Figure 2](#). This application note describes how to configure the HVPAK IC for this design approach.

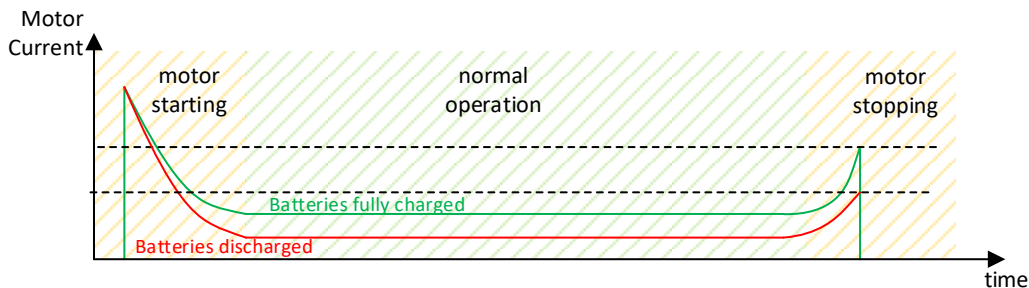

**Figure 2: Motor Current Waveform with Compensation**

## Smart Lock Motor Driver with Battery Discharge Compensation

### 4 Construction and Operation Principle

#### 4.1 Operation Principle

The behavior of the design can be divided into three sections, see [Figure 3](#):

**Motor stall checking:** if the motor current is too high after 100 ms of starting the motor, the driver turns off the motor. Also, the motor current is measured at this time.

**Current level setting:** current CMP Vref is set depending on the motor current (set higher than measured value).

**Overcurrent waiting:** if the motor current becomes higher than the selected value during this time, then the motor will be turned off.

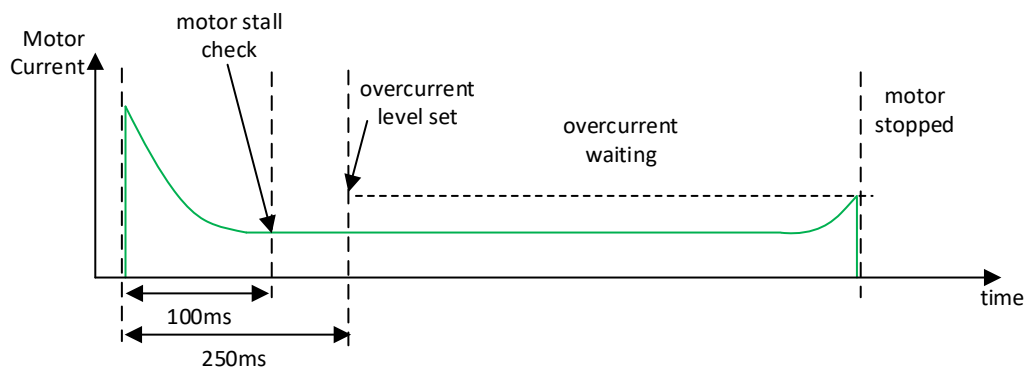

**Figure 3: Design Operations**

# Smart Lock Motor Driver with Battery Discharge Compensation

## 4.2 HVPAK Design

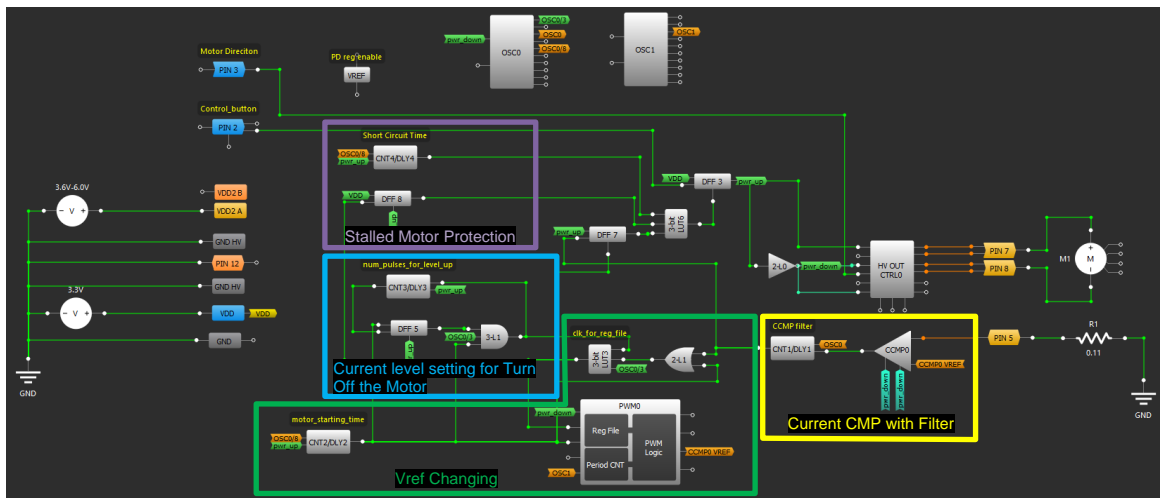

Figure 4: HVPAK Design

RegFile for current CMP is used to measure motor current. There are 16 values, which are switched from higher to lower, see Figure 5.

Byte #	Value	Duty Cycle	Vref
0	0	0.00 %	32 mV
1	4	3.15 %	160 mV
2	8	6.30 %	288 mV
3	12	9.45 %	416 mV
4	16	12.60 %	544 mV
5	20	15.75 %	672 mV
6	21	16.54 %	704 mV
7	22	17.32 %	736 mV
8	23	18.11 %	768 mV
9	24	18.90 %	800 mV
10	25	19.69 %	832 mV
11	27	21.26 %	896 mV
12	29	22.83 %	960 mV
13	31	24.41 %	1024 mV
14	33	25.98 %	1088 mV
15	35	27.56 %	1152 mV

Figure 5: RegFile Data

## Smart Lock Motor Driver with Battery Discharge Compensation

After 250 ms the Register File is switched by two values to set a new current level, as shown in Figure 6. When the motor current increases to this new current level, the motor will be turned off, see Figure 7.

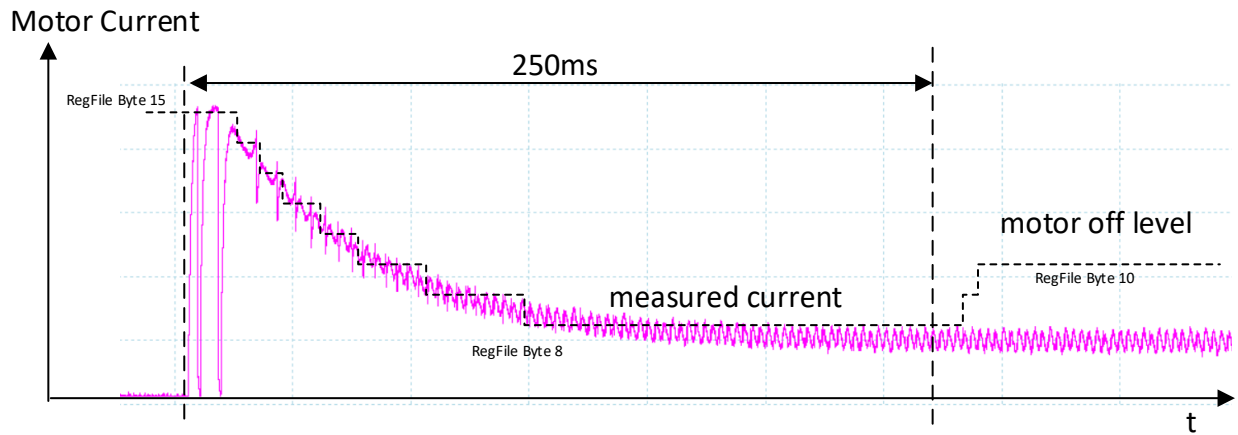

Figure 6: RegFile Usage

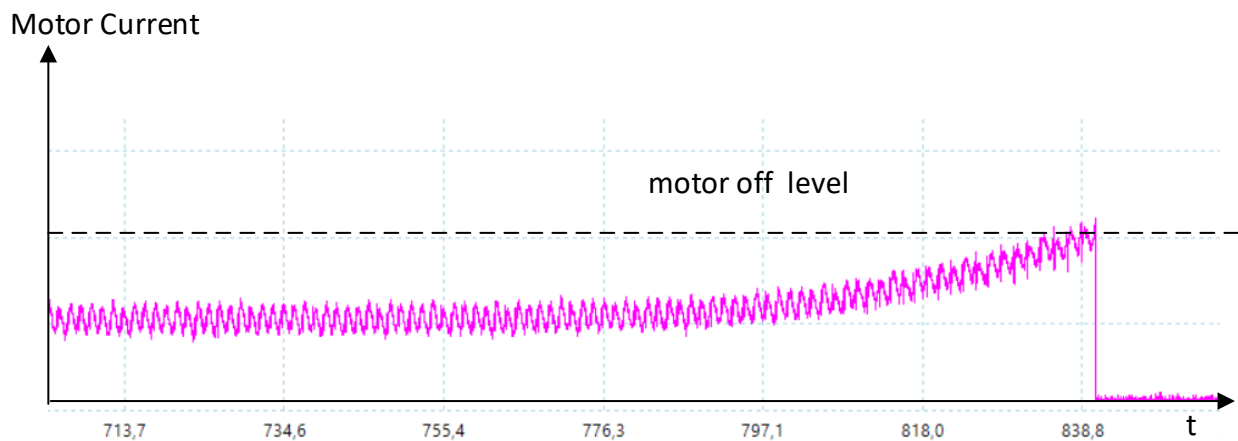
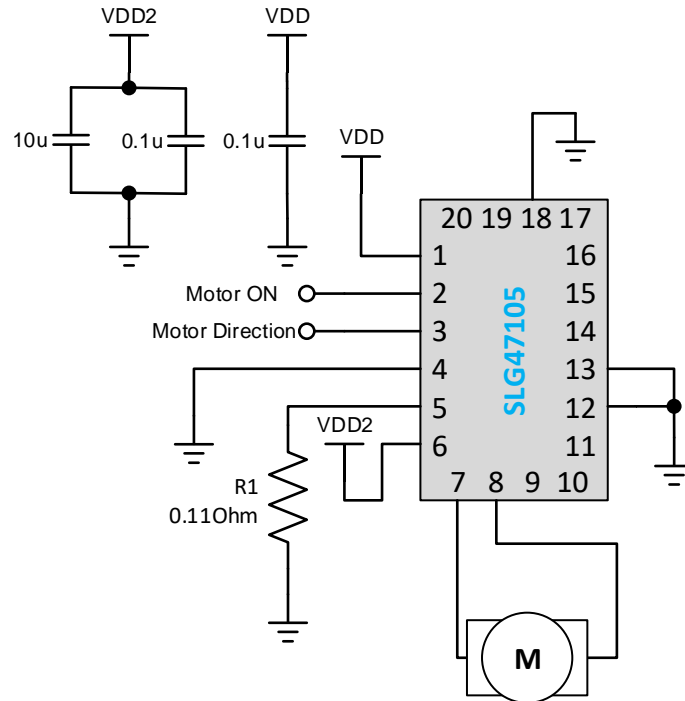

Figure 7: Motor Off Operation

For different power supply voltages and loads the motor current will be different. For higher motor current “motor off level” will become higher.

## Smart Lock Motor Driver with Battery Discharge Compensation

### 4.3 Application Circuit



**Figure 8: Typical Application Circuit**

PIN#2 Motor ON – rising edge turns on the motor.

PIN#3 Motor Direction – motor direction rotation: HIGH – forward rotation, LOW – reverse rotation.

VDD range: 2.3 V – 5.5 V.

VDD2 range: 3.6 V – 6.0 V.



## Smart Lock Motor Driver with Battery Discharge Compensation

### 4.4 Motor Test

Table 1: Motor Parameters

Winding Resistance	Winding Inductance	No-Load RMS Current	
		Power Supply 6.0 V	Power Supply 3.6 V
Ohm	uH	mA	mA
1.6	730	170	130

Motor starting current is about 2 A at power supply 6.0 V, and after 200 ms decreases to the nominal value, which depends on the power supply voltage. See Figure 9 through Figure 12.

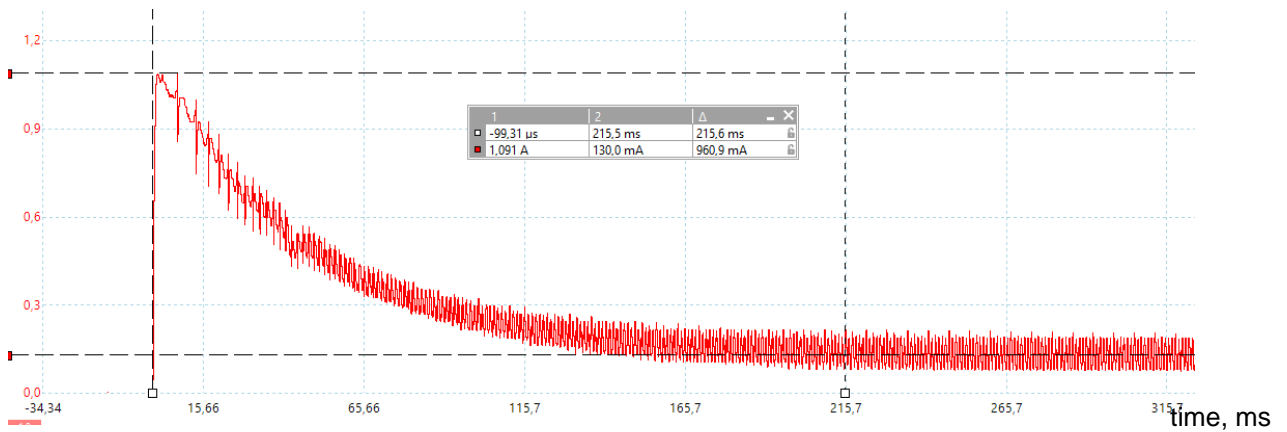

Figure 9: Motor Starting Current Waveform, Power Supply 3.6 V

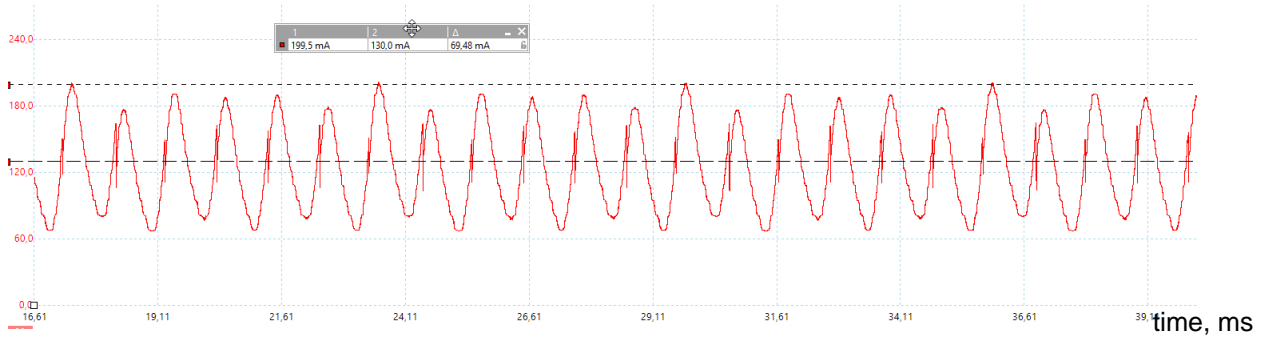

Figure 10: Motor No-Load Current, Power Supply 3.6 V

Smart Lock Motor Driver with Battery Discharge Compensation

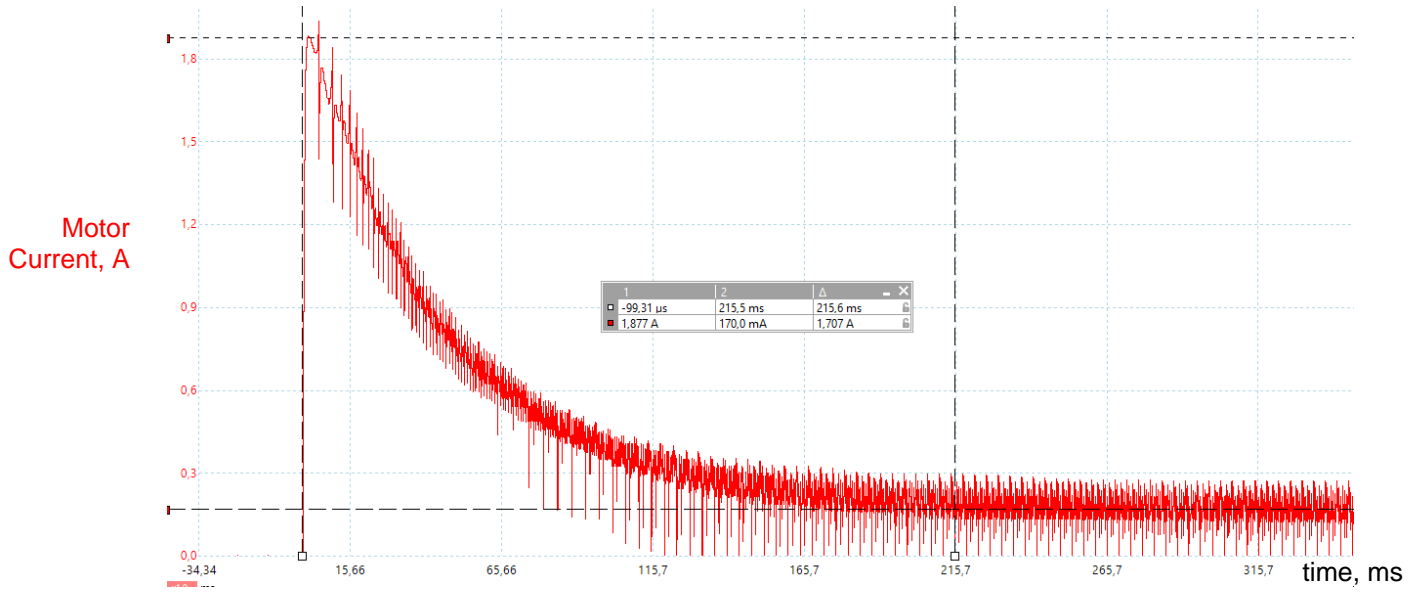

Figure 11: Motor Starting Current Waveform, Power Supply 6.0 V



Figure 12: Motor No-Load Current, Power Supply 6.0 V

Smart Lock Motor Driver with Battery Discharge Compensation

5 Design Operation Waveforms

5.1 Normal Operation

Power supply: 6.0 V.

Motor RMS current: 170 mA.

Motor Off current: 620 mA.

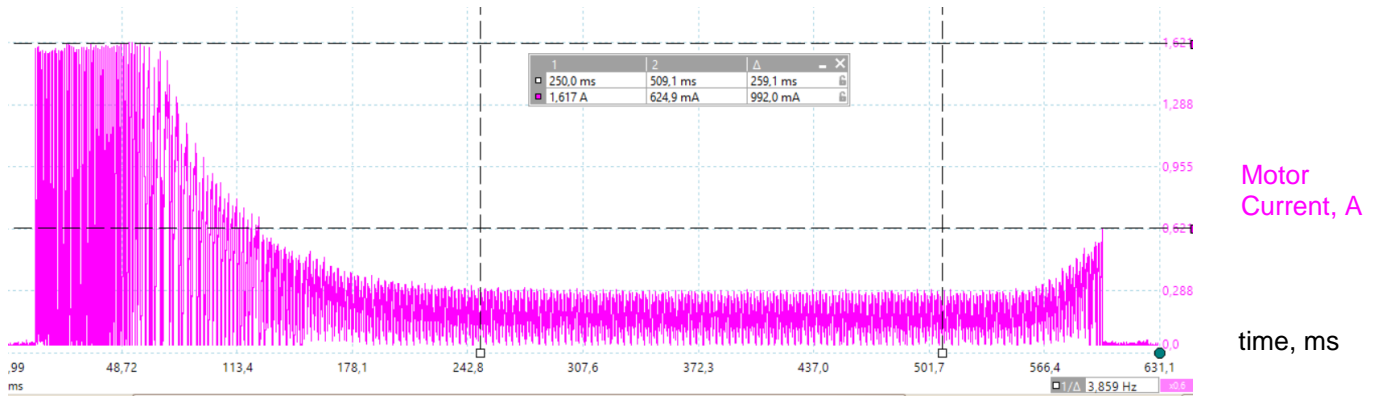

Figure 13: No-Load Motor, Power Supply 6.0 V

Power supply: 3.6 V.

Motor RMS current: 127 mA.

Motor Off current: 460 mA.

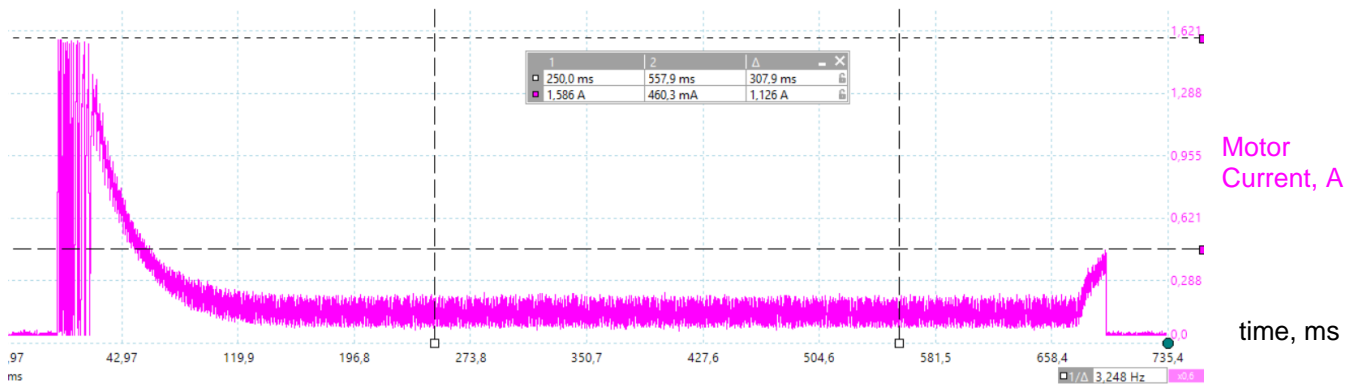

Figure 14: No-Load Motor, Power Supply 3.6 V

Smart Lock Motor Driver with Battery Discharge Compensation

Power supply: 3.0 V.

Motor RMS current: 310 mA.

Motor Off current: 670 mA.

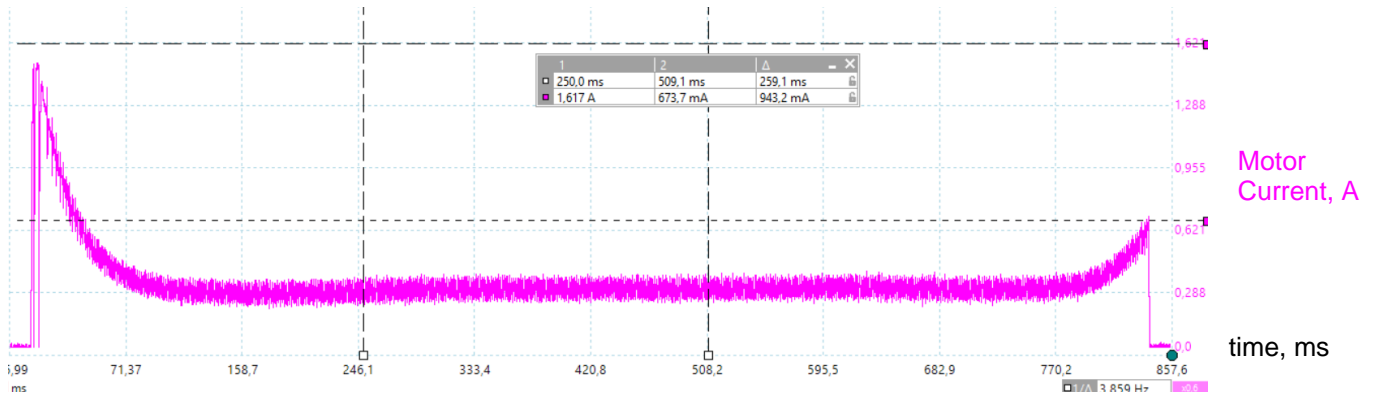

Figure 15: Loaded Motor, Power Supply 3.0 V

5.2 Stalled Motor at the Start

Motor Stall Detection time is 100 ms. If the motor current is high during 100 ms after the start, the motor will be automatically turned off.

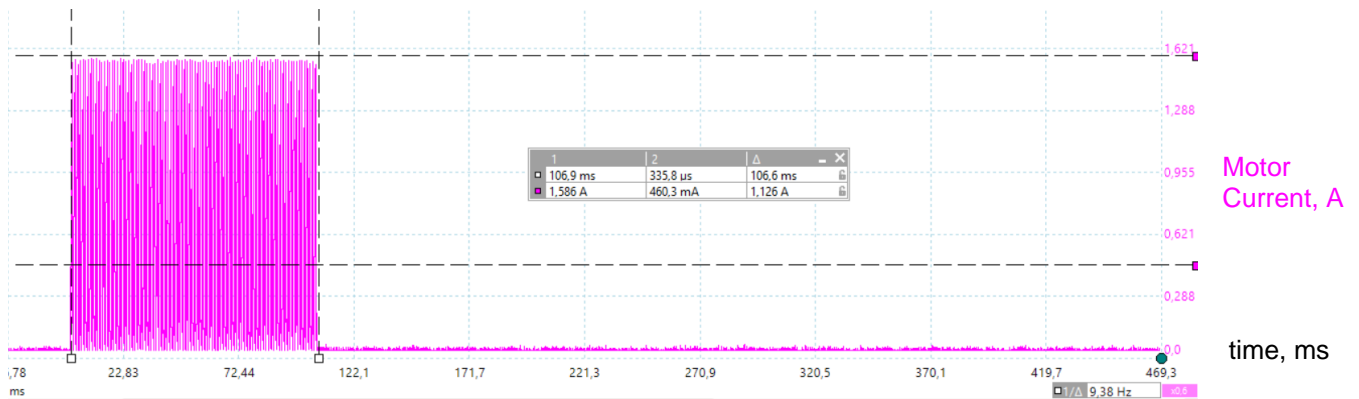

Figure 16: Stalled Motor, Power Supply 3.6 V – 6.0 V

---

---

## Smart Lock Motor Driver with Battery Discharge Compensation

### 6 Conclusion

This application note describes one specific example for HVPAK, and how it can be customized for a particular motor and battery set. It is a very flexible and simple solution for motor control using configurable internal logic that supports designer preferences. Integration of the motor driver within HVPAK means the entire circuit fits within a very small physical space.

The designer can tailor the circuitry for when the motor current or the power supply voltage is changing. HVPAK also allows design of a constant current and constant voltage motor driver with embedded protection features like Overcurrent, Undervoltage, Overtemperature, etc.

---

---

**Smart Lock Motor Driver with Battery Discharge Compensation**

**Revision History**

Revision	Date	Description
1.0	08-Jul-2020	Initial Version