

RZ/A3UL

Getting Started with RZ/A Flexible Software Package

Introduction

This manual describes how to use the RZ/A Flexible Software Package (FSP) for developing applications for the RZ microprocessor series.

Target Device

RZ/A3UL

Contents

1. Introduction.....	4
1.1 Overview.....	4
1.2 Introduction to FSP.....	4
1.2.1 Purpose	4
1.2.2 e2 studio IDE.....	4
1.3 Limitations	4
1.3.1 Hardware Initial Setup.....	4
2. Starting Development Introduction.....	5
2.1 e2 studio setup	5
2.1.1 What is e2 studio?.....	5
2.1.2 e2 studio Prerequisites.....	5
2.1.3 e2 studio installation for Windows PC.....	5
2.1.4 e2 studio installation for Linux PC.....	16
2.2 FSP setup.....	22
2.2.1 Installation of FSP Packs using Platform Installer.....	22
2.2.2 Installation of FSP Packs using Package Installer.....	26
2.2.3 Installation of FSP Packs using Package Zip file.....	28
3. Set up an SMARC EVK.....	30
3.1 Supported Debugger	30
3.2 Board Setup.....	30
3.2.1 Boot Mode	30
3.2.2 JTAG connection	31
3.2.3 Debug Serial (console output).....	31
3.2.4 Power Supply	32
3.2.5 How to check if your board is operational	33
4. Tutorial: Your First RZ MPU Project - Blinky.....	33
4.1 Tutorial Blinky.....	33
4.2 What Does Blinky Do?	33
4.3 Create a New Project for Blinky	34
4.3.1 Details about the Blinky Configuration	37
4.3.2 Configuring the Blinky Clocks.....	37
4.3.3 Configuring the Blinky Pins	37
4.3.4 Configuring the Parameters for Blinky Components.....	37
4.3.5 Where is main()?	37
4.3.6 Blinky Example Code	38
4.4 Build the Blinky Project.....	38
4.5 Debug the Blinky Project.....	39
4.5.1 Debug prerequisites	39

4.5.2	Debug steps	39
4.6	Details about the Debug Process	47
4.6.1	Run the Blinky Project	47
5.	FSP Application Launch with e2 studio	49
5.1	Create a Project	49
5.1.1	What is a Project?	49
5.1.2	Creating a New Project	51
5.2	Configuring a Project	55
5.2.1	Summary Tab	55
5.2.2	Configuring the BSP	56
5.2.3	Configuring Clocks	56
5.2.4	Configuring Pins	58
5.2.5	Configuring Interrupts from the Stacks Tab	59
5.2.6	Creating Interrupts from the Interrupts Tab	59
5.2.7	Viewing Event Links	59
5.2.8	Adding Threads and Drivers	60
5.2.9	Adding and Configuring HAL Drivers	60
5.2.10	Adding Drivers to a Thread and Configuring the Drivers	61
5.2.11	Configuring Threads	63
5.3	Reviewing and Adding Components	66
5.4	Debugging the Project	66
5.5	Modifying Toolchain Settings	68
5.6	Importing an Existing Project into e2 studio	68
6.	Notes on development	72
6.1	Unexpected Update of Program placed on Flash ROM	72
6.2	Getting USB Hub to be workable with USBX	73
	Revision History	74

1. Introduction

1.1 Overview

This application note describes how to use the Renesas RZ/A Flexible Software Package (FSP) running on the Cortex®-A55 (hereinafter referred to as CA55) incorporated on RZ/A3UL.

1.2 Introduction to FSP

1.2.1 Purpose

The Renesas RZ/A Flexible Software Package (FSP) is an optimized software package designed to provide easy to use, scalable, high-quality software for embedded system design. The primary goal is to provide lightweight, efficient drivers that meet common use cases in embedded systems.

1.2.2 e2 studio IDE

FSP provides a host of efficiency enhancing tools for developing projects targeting the Renesas RZ series of MPU devices. The e2 studio IDE provides a familiar development cockpit from which the key steps of project creation, module selection and configuration, code development, code generation, and debugging are all managed.

1.3 Limitations

1.3.1 Hardware Initial Setup

RZ/A FSP expects the initial setup of hardware should be carried out beforehand by RZ/A Initial Program Loader (hereinafter referred to as IPL). For detail on IPL, please refer to the [Application Note](#).

2. Starting Development Introduction

2.1 e2 studio setup

2.1.1 What is e2 studio?

Renesas e2 studio is a development tool encompassing code development, build, and debug. e2 studio is based on the open-source Eclipse IDE and the associated C/C++ Development Tooling (CDT).

When developing for RZ MPUs, e2 studio hosts the RZ/A FSP. The FSP provides a wide range of time saving tools to simplify the selection, configuration, and management of modules and threads, to easily implement complex applications.

2.1.2 e2 studio Prerequisites

2.1.2.1 Obtaining an RZ MPU Kit

To develop applications with RZ/A FSP, start with RZ/A3UL Evaluation Board Kit.

RZ/A3UL Evaluation Board Kit related information is available at [RZ/A3UL Evaluation Board Kit](#).

The relationship between the board type and the board name on e²studio is as follows.

	Board name on GUI screen	Note
QSPI Edition (RTK9763U02S01000BE)	RZ/A3UL Evaluation Board Kit QSPI Edition (Exec with DDR SDRAM)	If you select this, the initial program loader will transfer the entire program including the code area to DDR4.
	RZ/A3UL Evaluation Board Kit QSPI Edition (eXecute-In-Place)	If you select this, only the data area will be transferred to DDR4 by the initial program loader. The code area on the flash ROM is referenced during execution.
Octal-SPI Edition (RTK9763U02S01001BE)	RZ/A3UL Development board Dialog OCTAL Boot (eXecute-In-Place)	If you select this, only the data area will be transferred to OctaRAM by the initial program loader. The code area on the flash ROM is referenced during execution.

2.1.2.2 PC Requirements

The following are the minimum PC requirements to use e2 studio:

- Windows 10 or Ubuntu 20.04 LTS Desktop(64-bit) with Intel i5 or i7, or AMD A10-7850K or FX
- Memory: 8-GB DDR3 or DDR4 DRAM (16-GB DDR4/2400-MHz RAM is preferred)
- Minimum 250-GB hard disk

2.1.2.3 Licensing

FSP licensing includes full source code, limited to Renesas hardware only.

2.1.3 e2 studio installation for Windows PC

This chapter describes how to install the e2 studio IDE on Windows PC. If you would like to install e2 studio and FSP at the same time, please jump to 2.2.1.

2.1.3.1 Download

The latest e2 studio IDE installer package can be downloaded from Renesas website for free. Please check detailed information from: <https://www.renesas.com/e2studio>. Note that user has to login to the Renesas account (in MyRenesas page) for the software download.

2.1.3.2 Installation of e2 studio IDE

1. Double-click the e2 studio installer to launch the e2 studio installation wizard. Then, select the [Custom Install] option and click the [Next] button.

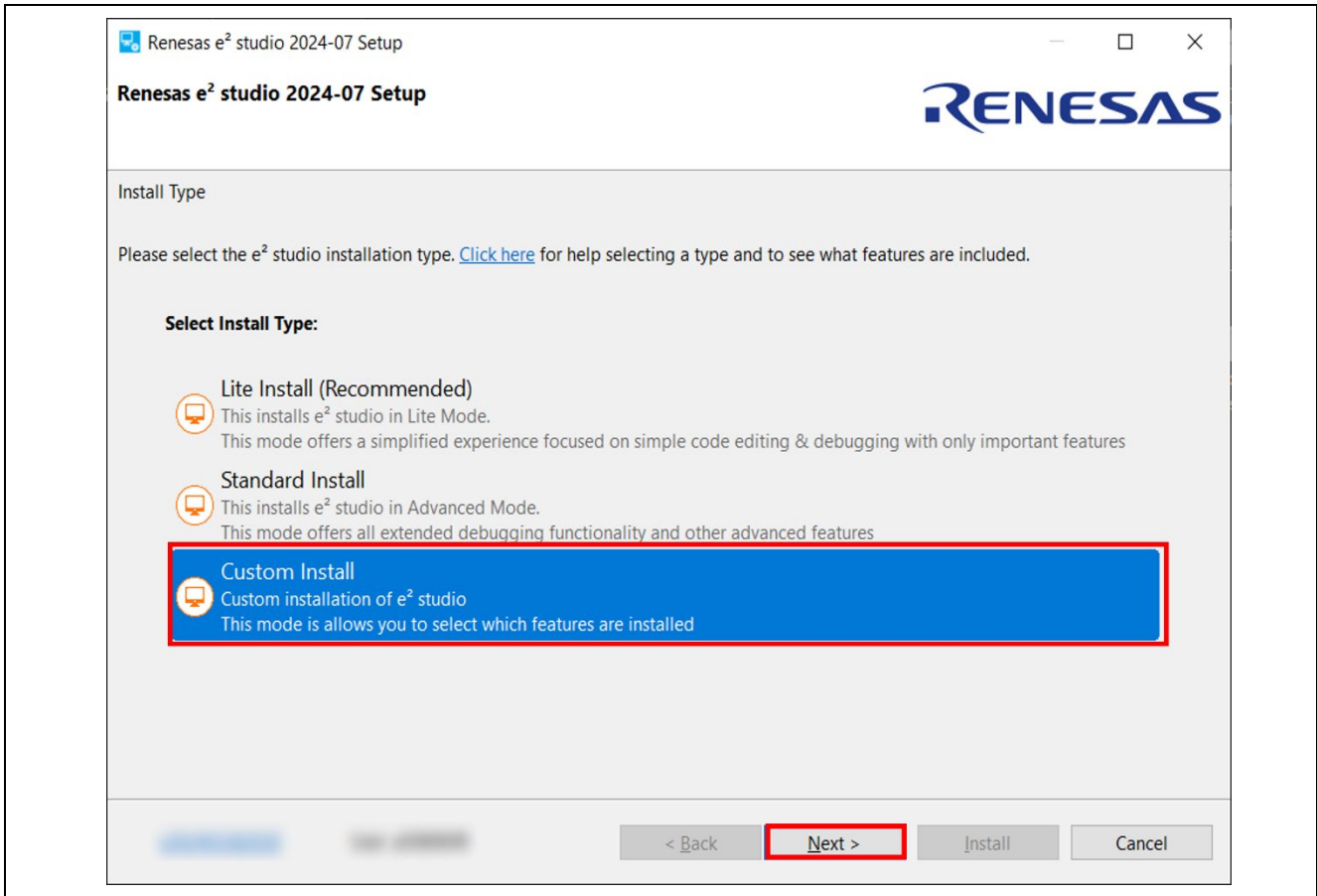

Figure 1: e2 studio installation wizard

Note:

If you are using a multi-user environment, you may receive a prompt to confirm whether you want to install it for the current user only or for all users.

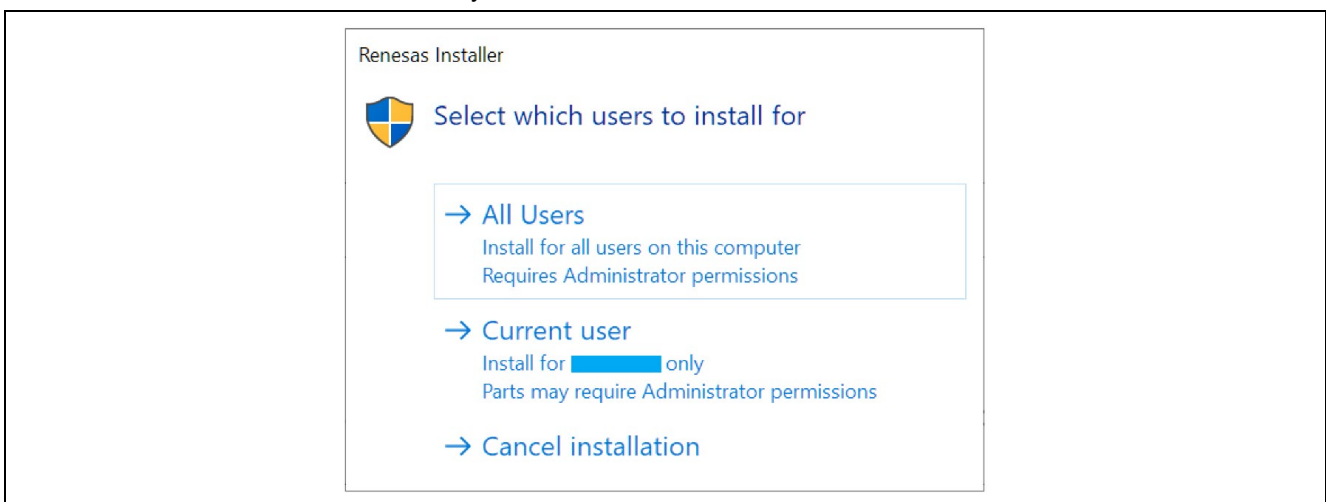

Figure 2: Select User for Installation

2. Welcome page

User can change the install folder by clicking [**Change...**]. Click [**Next**] to continue.

Note:

1. If you would like to have multiple versions of e2 studio, please specify new folder here.
2. Multi-byte characters cannot be used for e2 studio installation folder name.

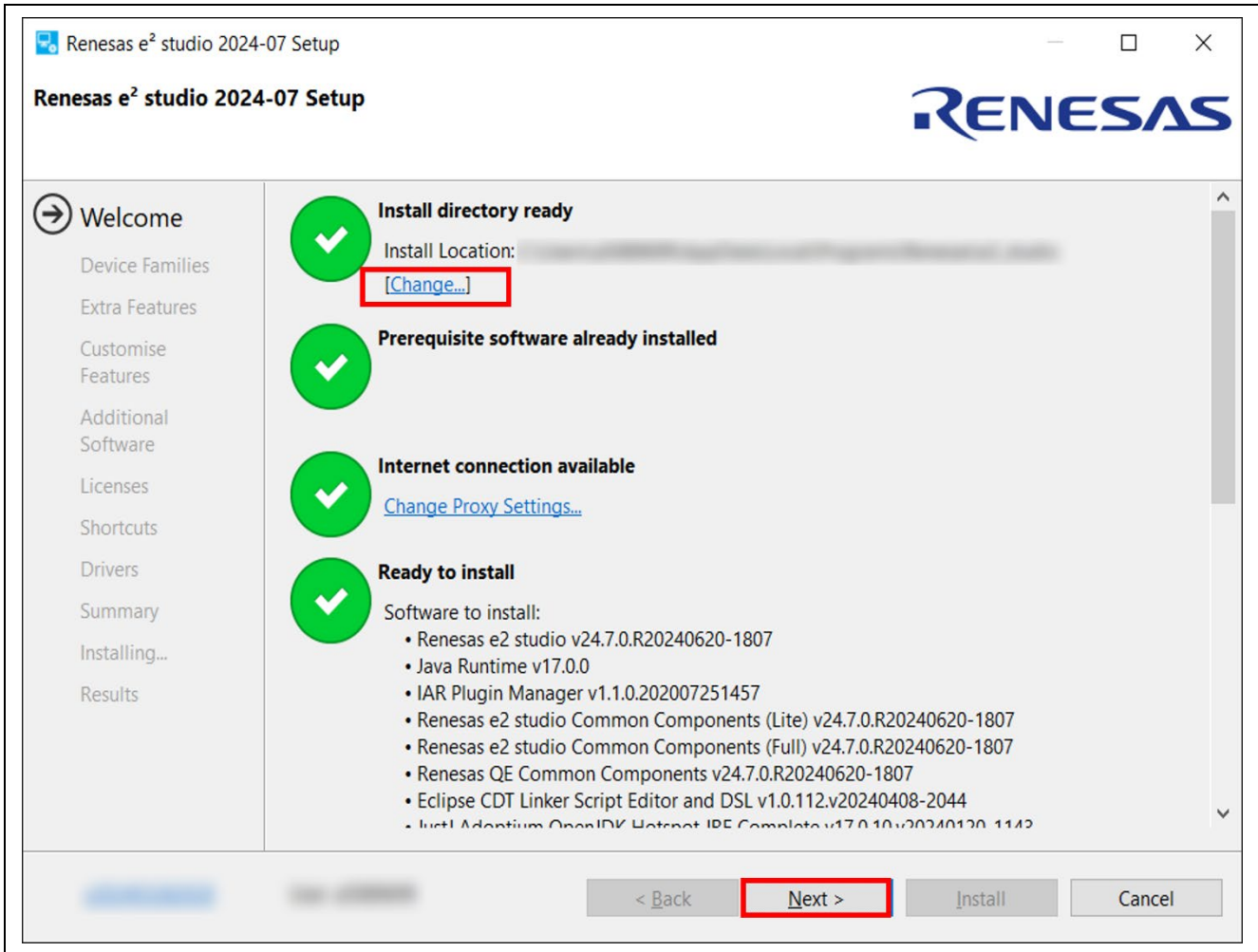

Figure 3: Installation of e2 studio – Welcome page

3. Device Families

Select Devices Families to install. Click the [Next] button to continue.

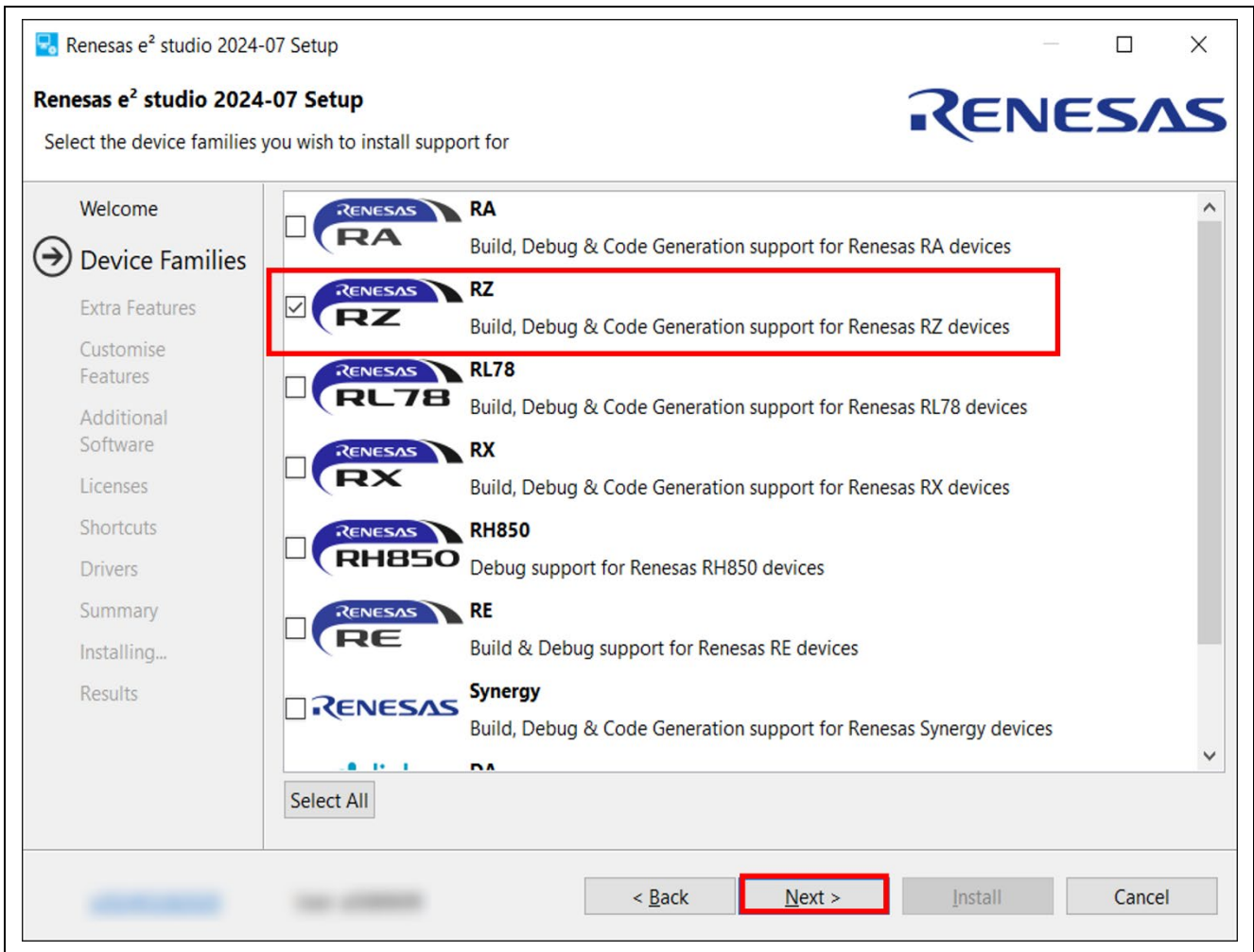

Figure 4: Installation of e2 studio – Device Families

4. Extra Features

Select Extra Features (i.e., Language packs, Git support...) to be installed. For non-English language users, please select Language packs at this step if needed. Then, click the [Next] button to continue.

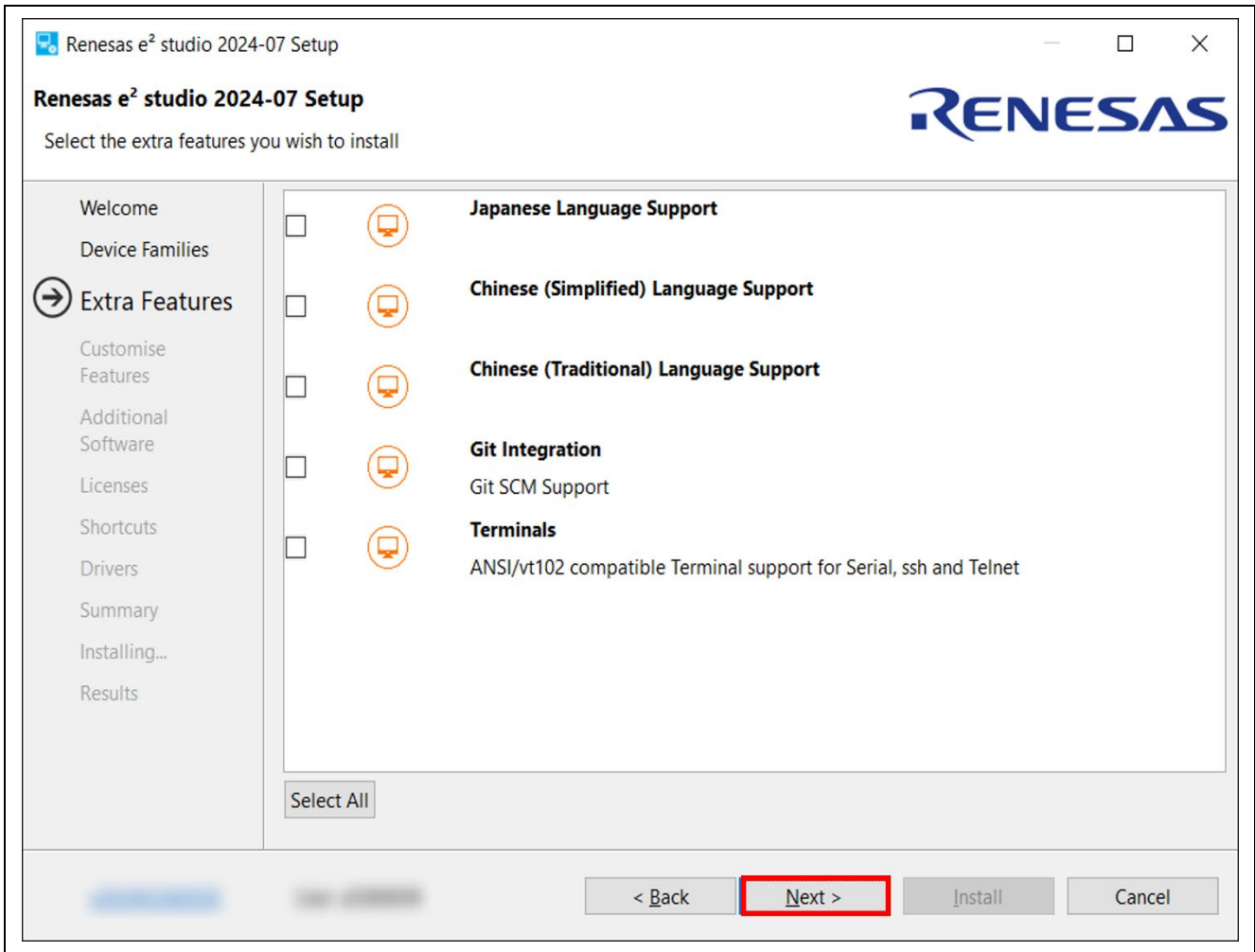

Figure 5: Installation of e2 studio – Extra Features

5. Customize Features

Select the components to install and click the [Next] button to continue. Be sure to choose “Renesas FSP Smart Configurator Core”. Otherwise, FSP won't be built on e2 studio successfully.

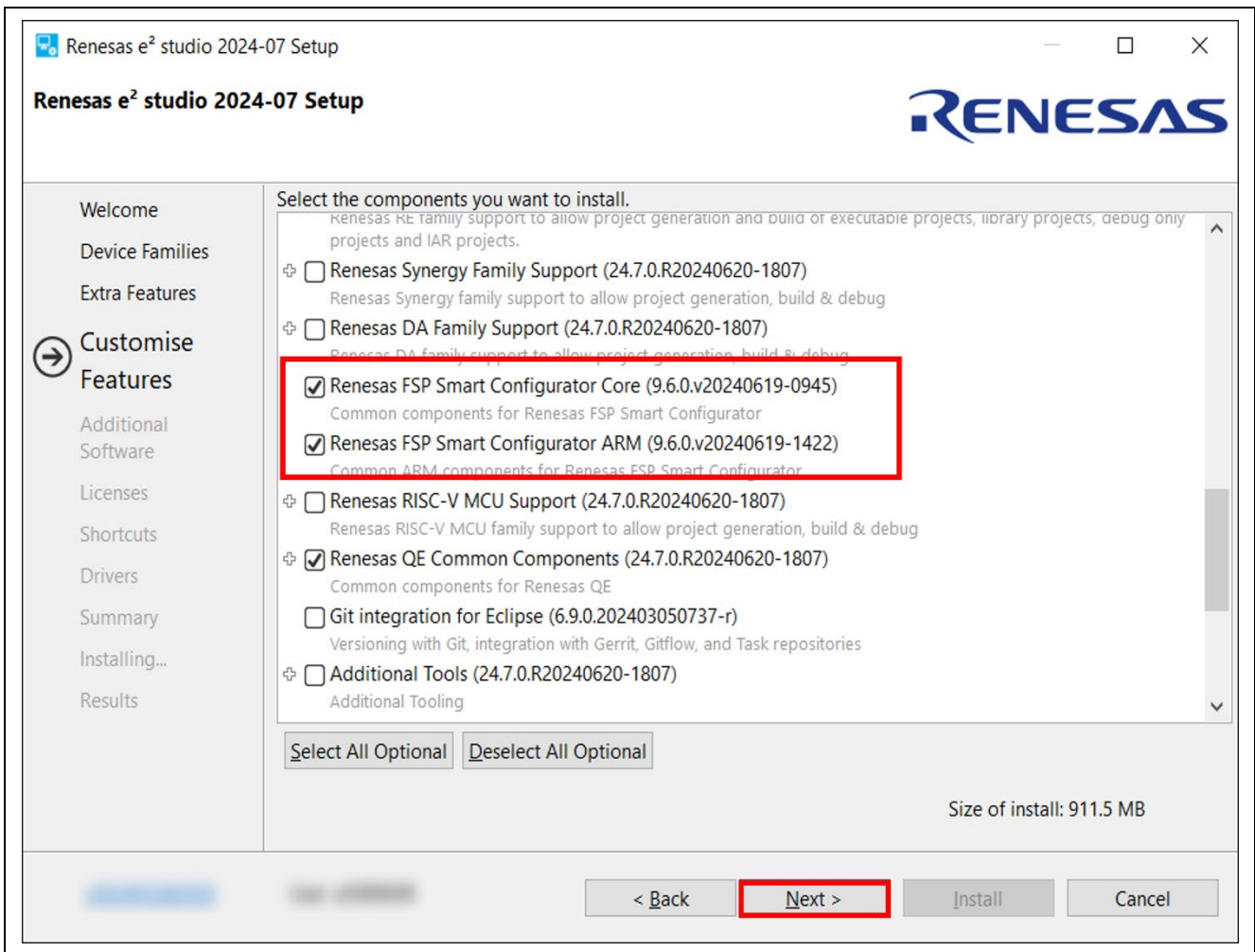

Figure 6: Installation of e2 studio – Features

6. Additional Software

Select additional software (i.e., compilers, utilities, QE...) to be installed. Be sure that you select the "GCC toolchains & Utilities" tab, choose the following items, and click [Next] to continue.

- GCC ARM A-Profile (AArch64 bare-metal) 13.2 rel1

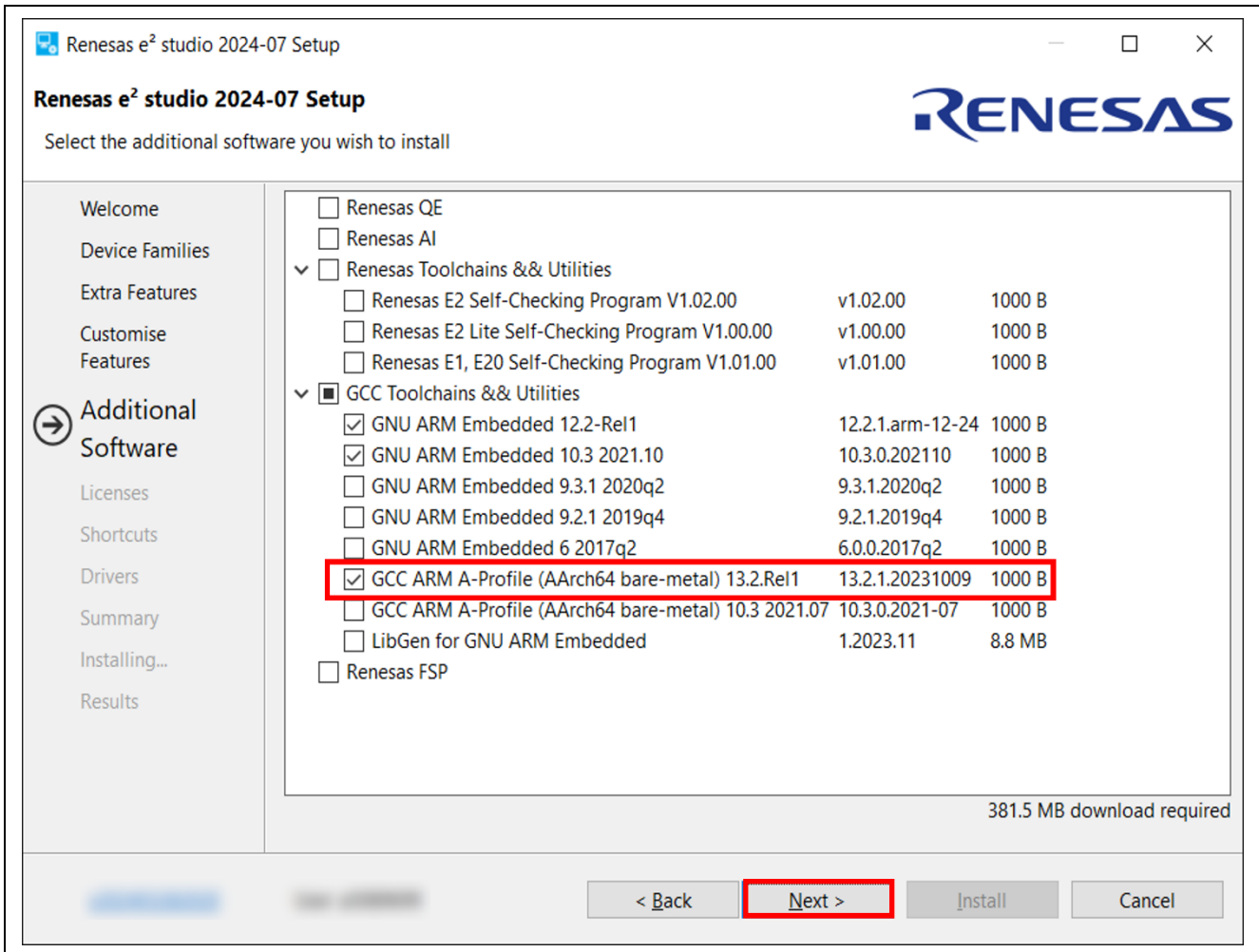

Figure 7: Installation of e2 studio – Additional Software

7. Licenses Agreement

Please read and accept the software license agreement, then click the [Next] button. Note that acceptance of the license agreement is mandatory; without it, the installation process cannot proceed.

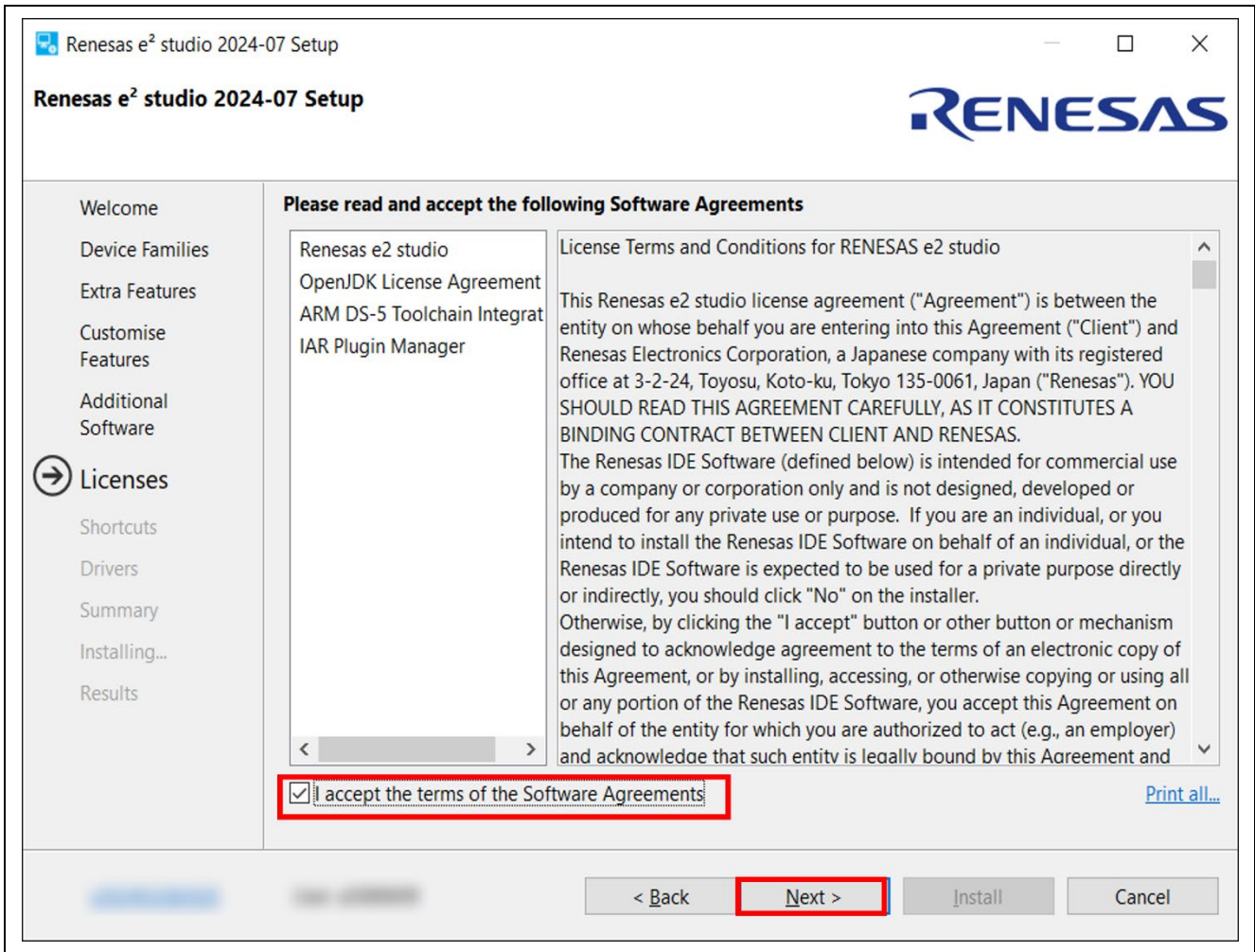

Figure 8: Installation of e2 studio – Licenses

8. Shortcuts

Select a shortcut name for the start menu and click the [Next] button to continue.

Note:

If e2 studio was installed in another location, it is recommended to rename it to distinguish from the other e2 studio(s).

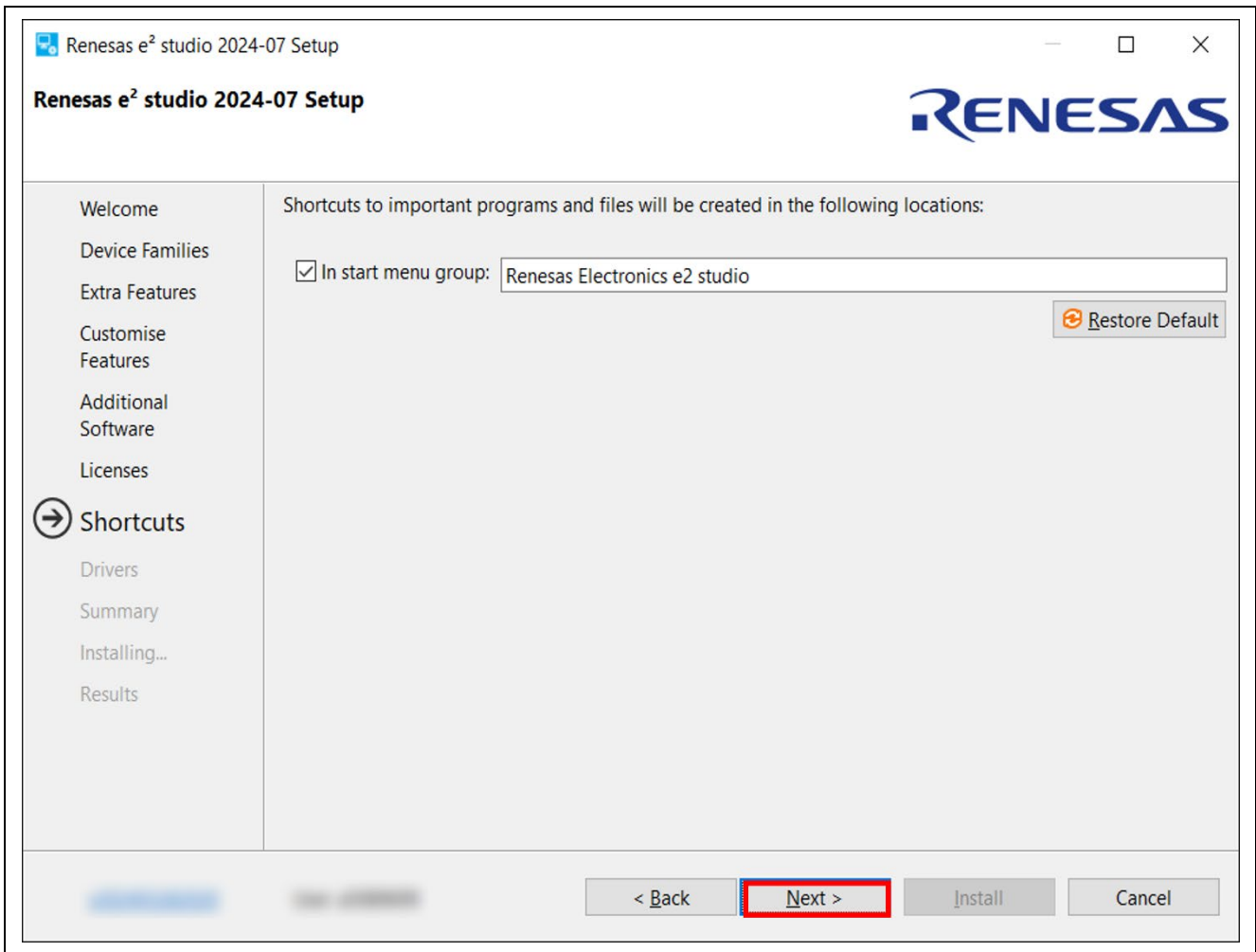

Figure 9: Installation of e2 studio – Shortcuts

9. Summary

On the summary page, a list of components to be installed will be displayed. Please review the contents and click the [Install] button to proceed with the installation of the Renesas e2 studio IDE.

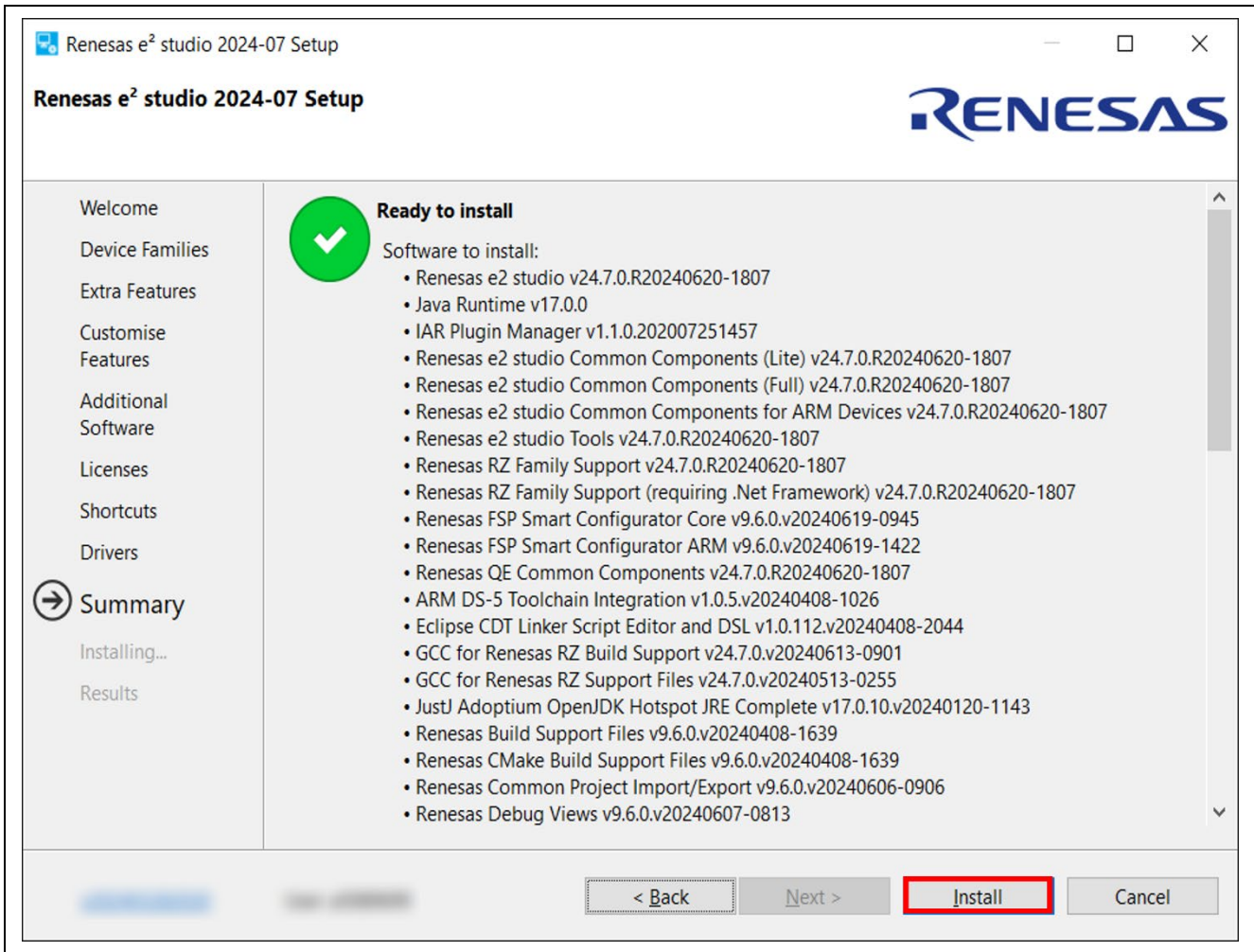

Figure 10: Installation of e2 studio – Summary

10. Installing...

The installation will proceed. Depending on selected items of the additional software, new dialog prompts may appear during the installation process. Please follow the instructions provided by the installer when this occurs.

11.Results

If the installation has been successfully completed, you should see the following information.

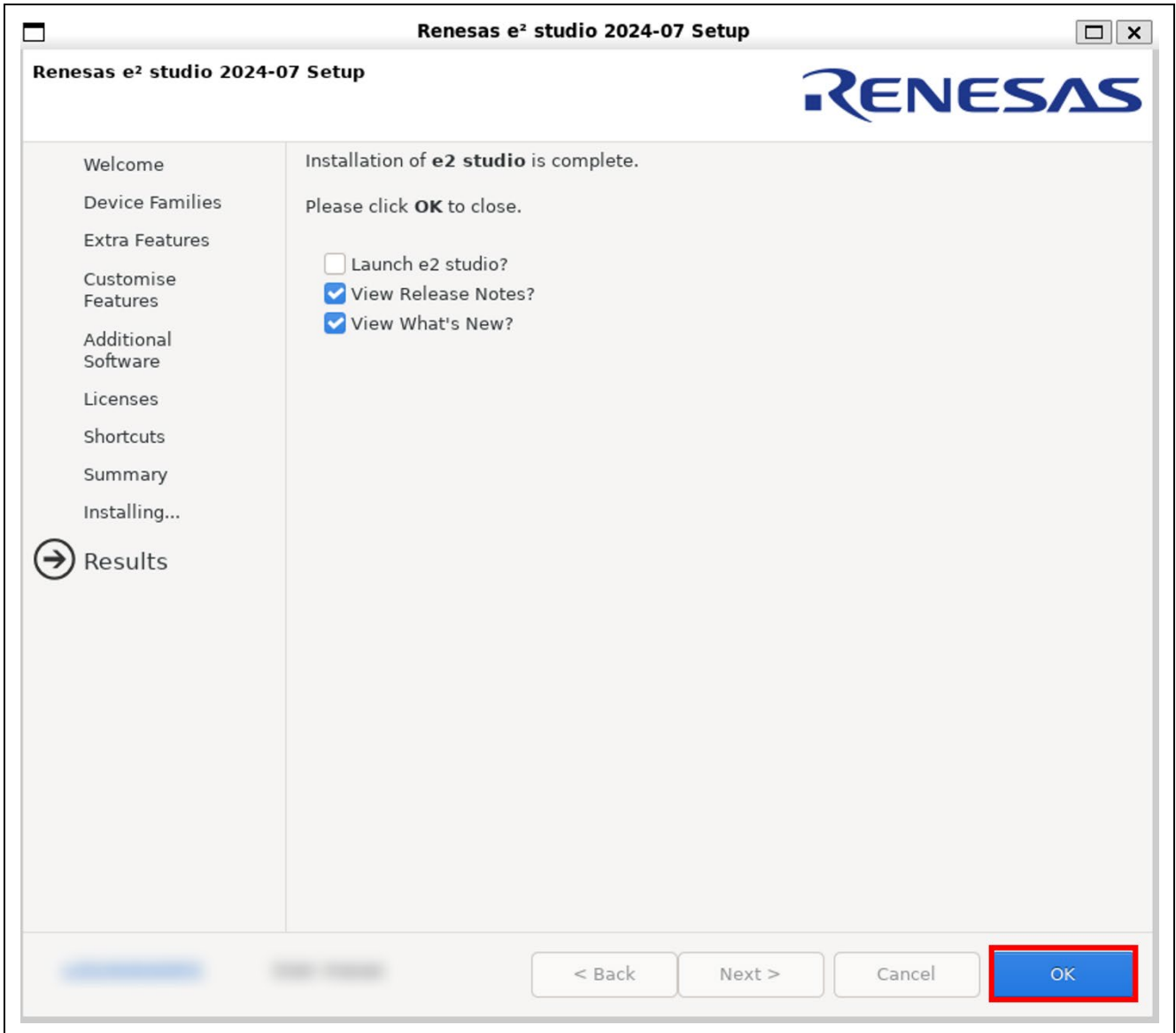

Figure 1: Results Page

2.1.4 e2 studio installation for Linux PC

This chapter describes how to install the e2 studio IDE on Linux PC.

2.1.4.1 Prerequisite

Please download the development tool related stuff:

- **SEGGER J-Link driver**

Please download the driver V7.92c or after from:

https://www.segger.com/downloads/jlink/JLink_Linux_x86_64.deb

- **e2 studio IDE installer**

The latest e2 studio IDE installer package can be downloaded from Renesas website for free. Please check detailed information from: <https://www.renesas.com/e2studio>.

2.1.4.2 Installation

This section describes the procedure of each software installation. Filename, version number and the file path are just examples. Please replace those in accordance with your environment.

- **Segger J-Link driver**

Open a terminal window and enter the commands stated below:

```
$ sudo dpkg -i JLink_Linux_V792c_x86_64.deb
```

If the previous installation fails with unmet dependencies, please retry as follows:

```
$ sudo apt-get -f install
$ sudo dpkg -i JLink_Linux_V792c_x86_64.deb
```

- **e2 studio**

1. Run the e2 studio IDE Installer “./e2studio_installer-yyyy-mm_linux_host.run”. (Before running the installer, check the execution permission of the installer.)
2. User needs to select Install Type as shown below. In this material, it is expected that Custom Install is selected. Then, click [Next >] to continue.

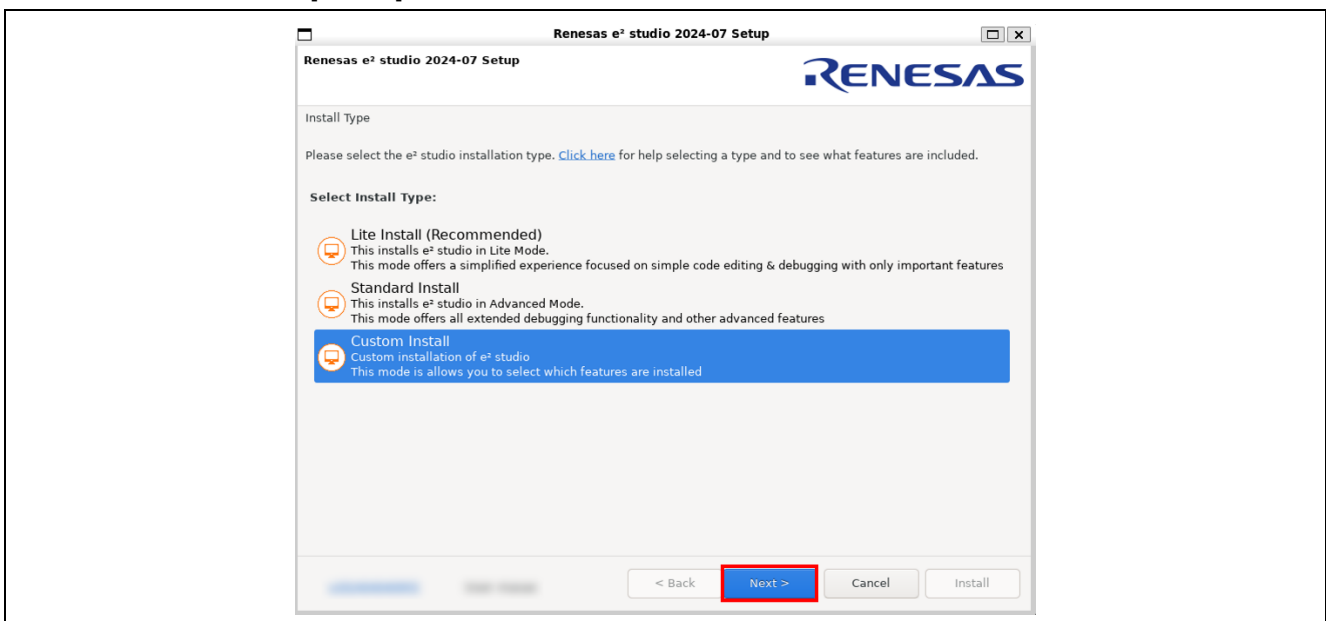

Figure 2: Selection of Install Type

3. User can change the install folder by clicking [Change...]. Click [Next] to continue.

Note:

1. If you would like to have multiple versions of e2 studio, please specify new folder here.
2. Multi-byte characters cannot be used for e2 studio installation folder name.

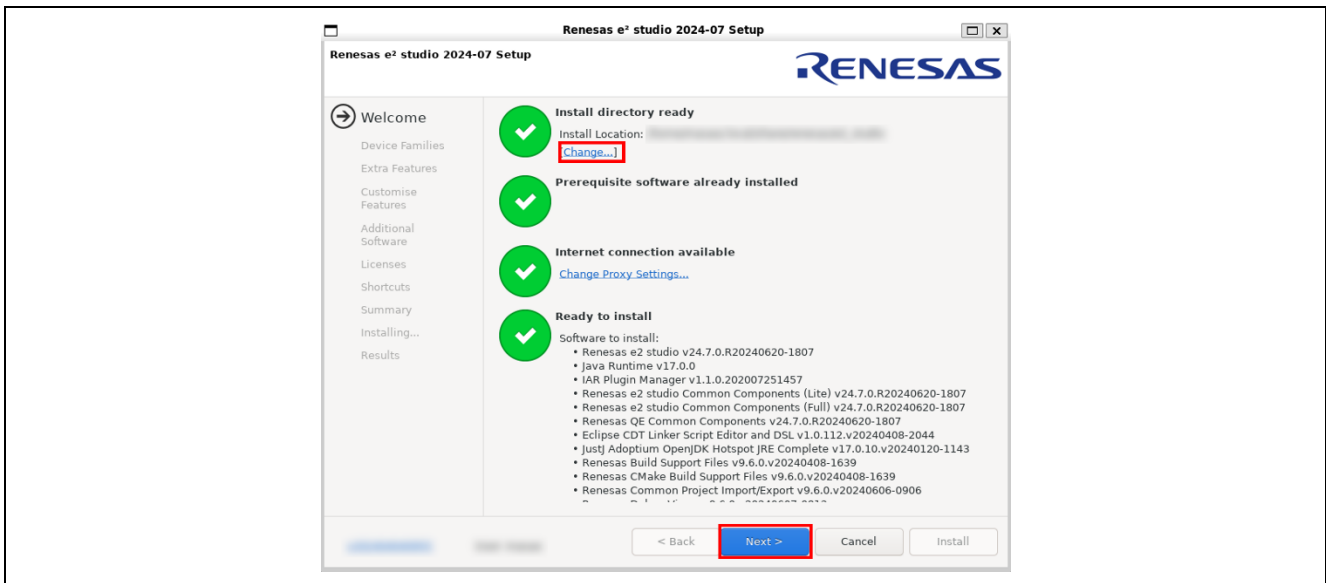

Figure 3: Installation of e2 studio – Welcome page

3. Device Families

Select Devices Families to install. Click the [Next] button to continue.

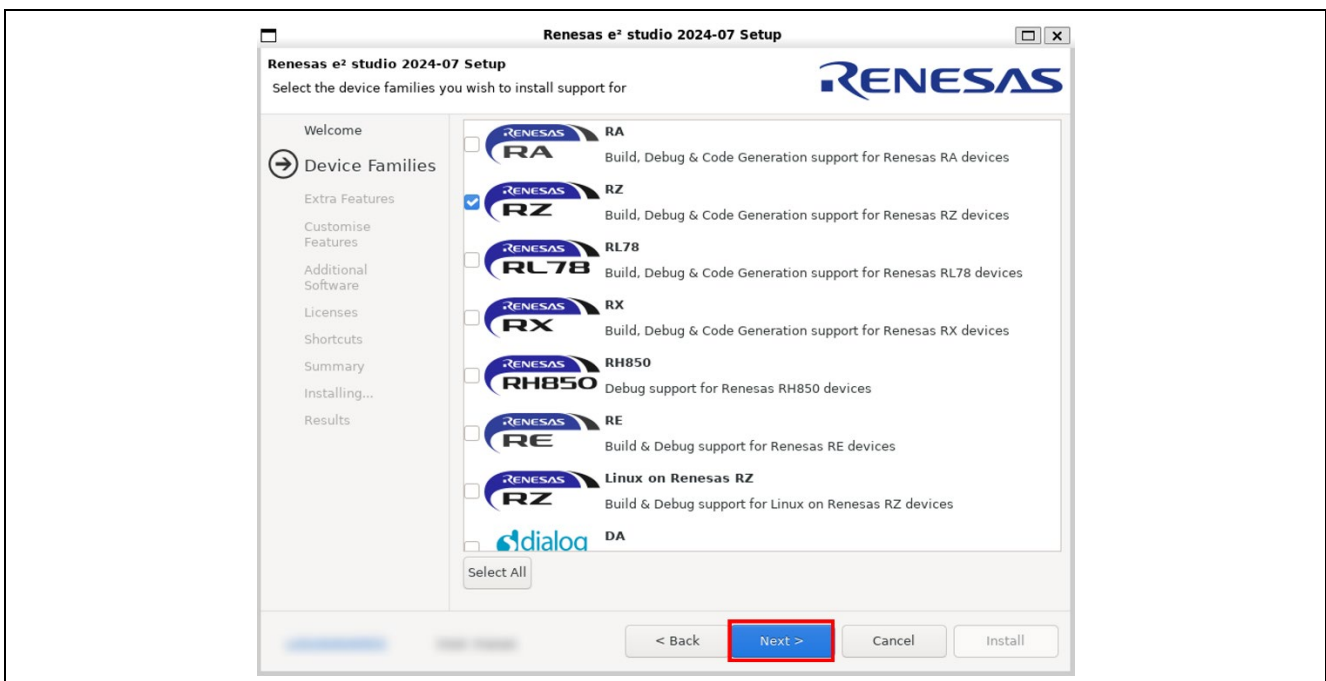

Figure 4: Installation of e2 studio – Device Families

4. Extra Features

Select Extra Features (i.e., Language packs, SVN & Git support, RTOS support...) to be installed. For non-English language users, please select Language packs at this step if needed. Then, please click the [Next] button to continue.

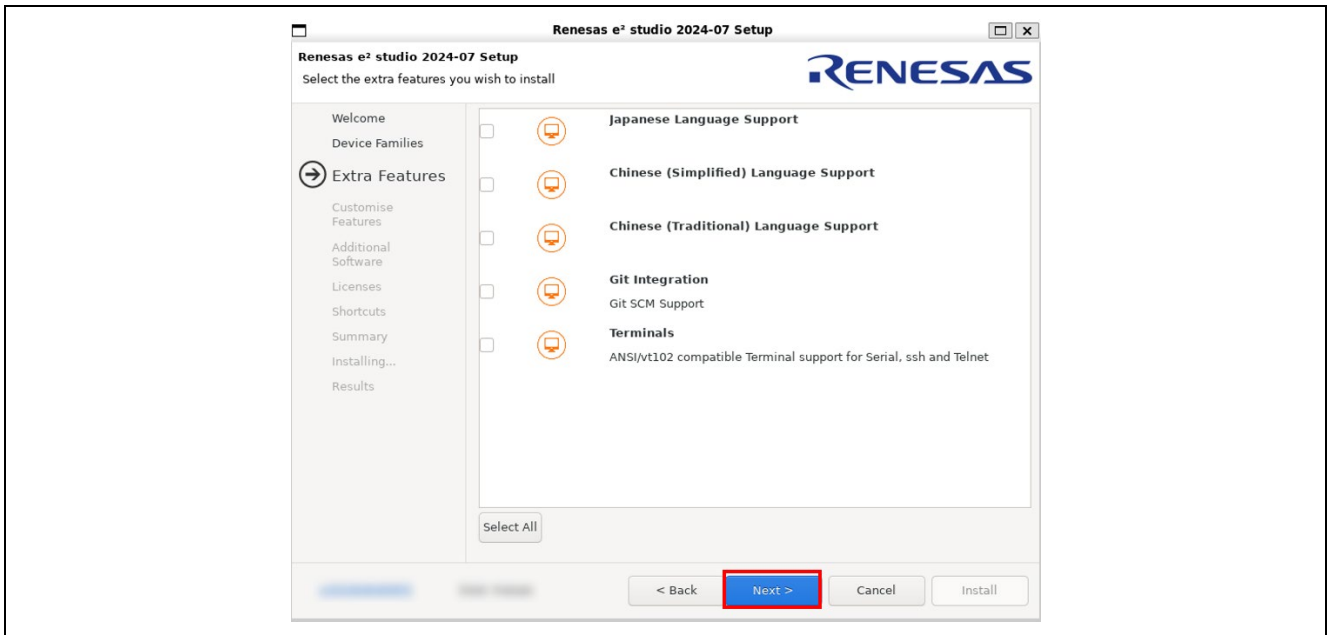

Figure 5: Installation of e2 studio – Extra Features

5. Customize Features

Select the components to install and click the [Next] button to continue. Be sure that “Renesas FSP Smart Configurator Core” is certainly selected.

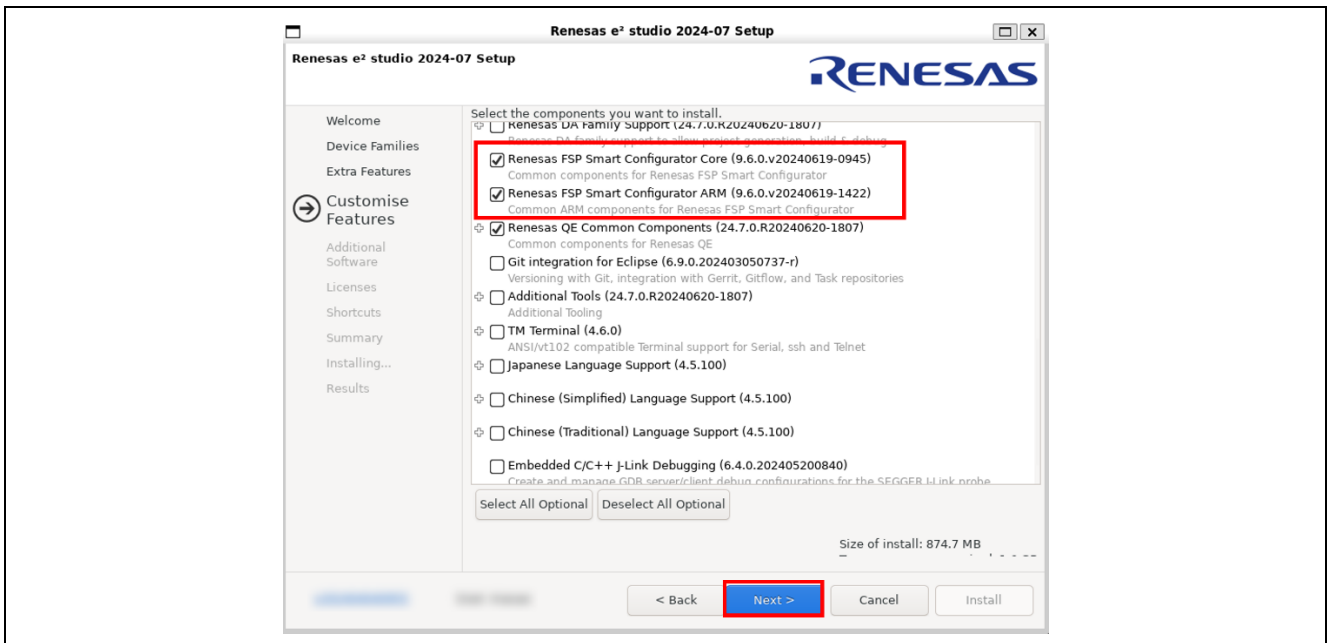

Figure 6: Installation of e2 studio – Features

6. Customize Features

Select additional software (i.e., compilers, utilities, QE...) to be installed. Be sure that you select the “GCC toolchains & Utilities” tab, choose the following items, and click [Next] to continue.

- GCC ARM A-Profile (AArch64 bare-metal) 13.2 rel1

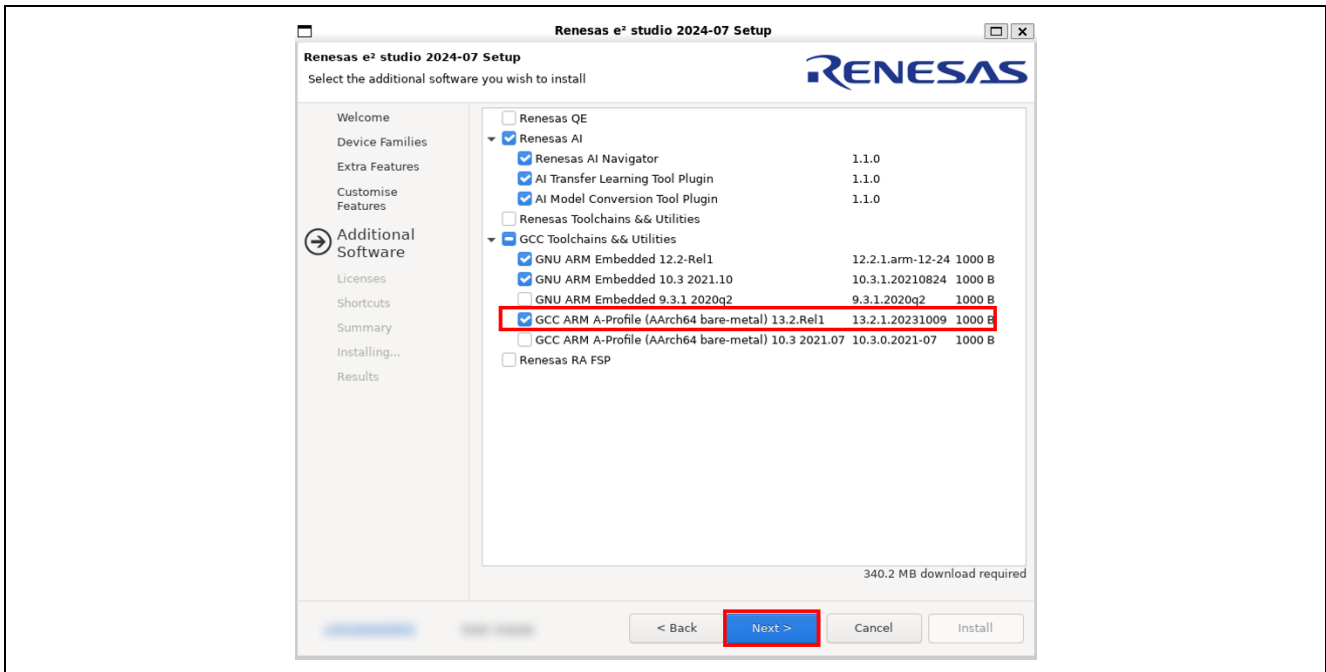

Figure 7: Installation of e2 studio – Additional Software

7. License Agreement

Read and accept the software license agreement. Click the [Next] button. Please note that user must accept the license agreement, otherwise installation cannot be continued.

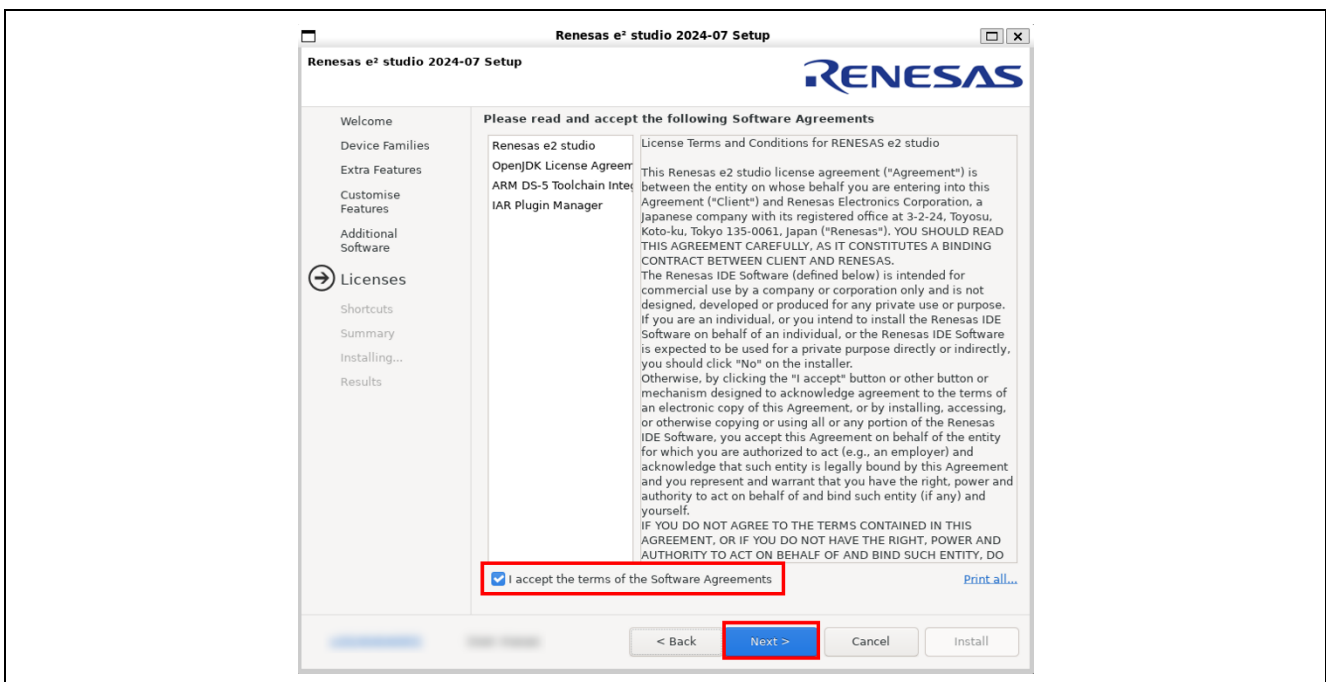

Figure 8: Installation of e2 studio – Licenses

8. Shortcuts

Select shortcut name for start menu and click [Next] button to continue.

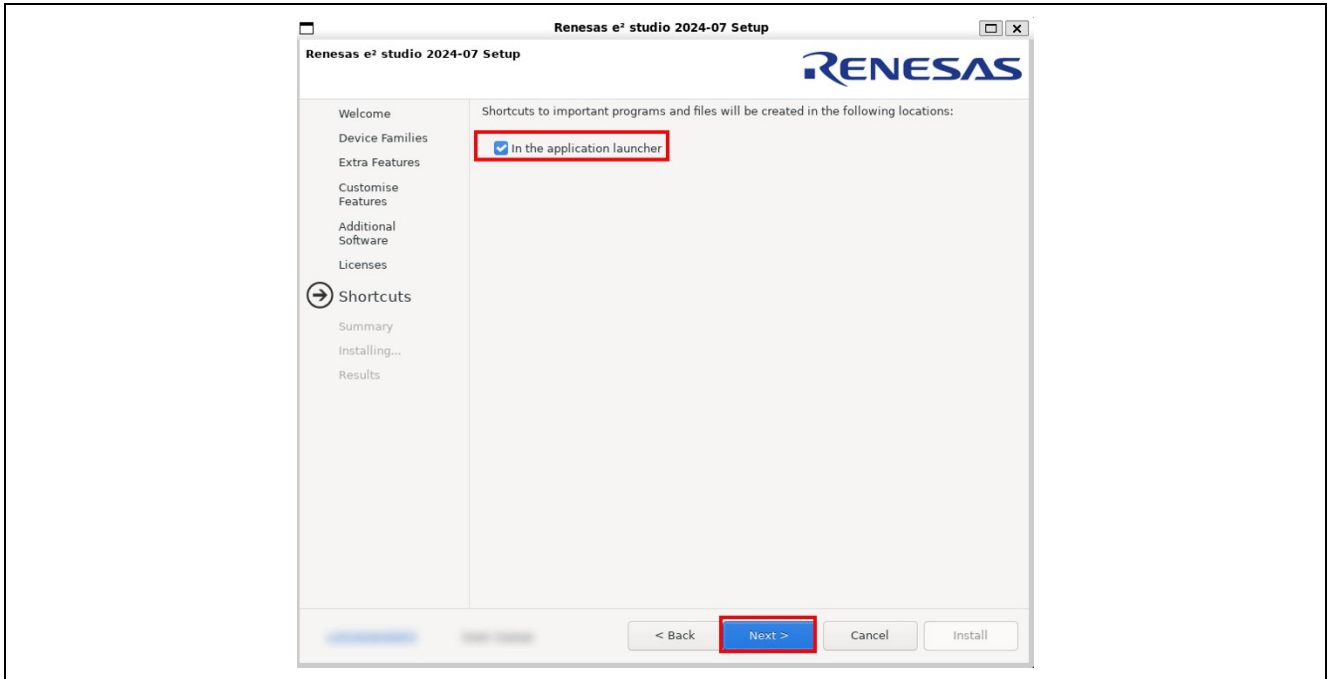

Figure 9: Installation of e2 studio – Shortcuts

9. Summary

Components list to be installed is shown. Please confirm the contents and click the [Install] button to install the Renesas e2 studio IDE.

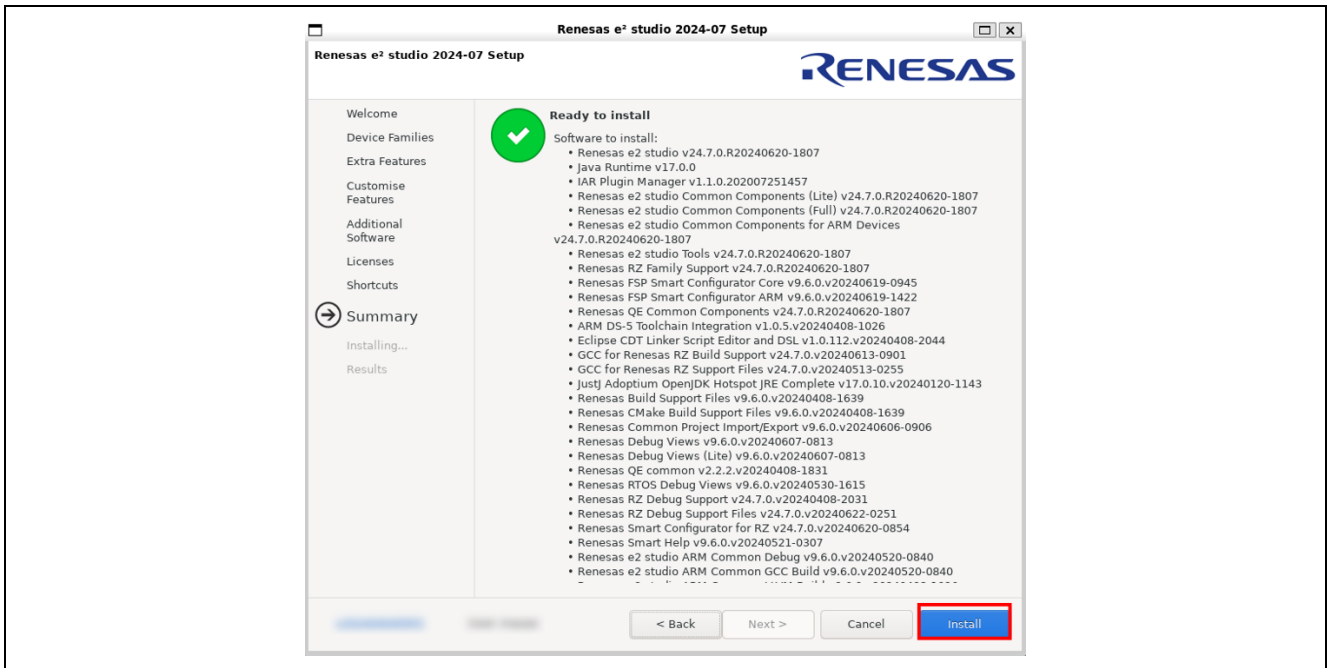

Figure 10: Installation of e2 studio – Summary

10. Installing...

The installation is performed. Depending on selected items of additional software, new dialog prompts may appear during the installation process. Please see chapter 2.1.3.2 for more detailed information.

11. Results

If the installation is successfully done, you should see the following information.

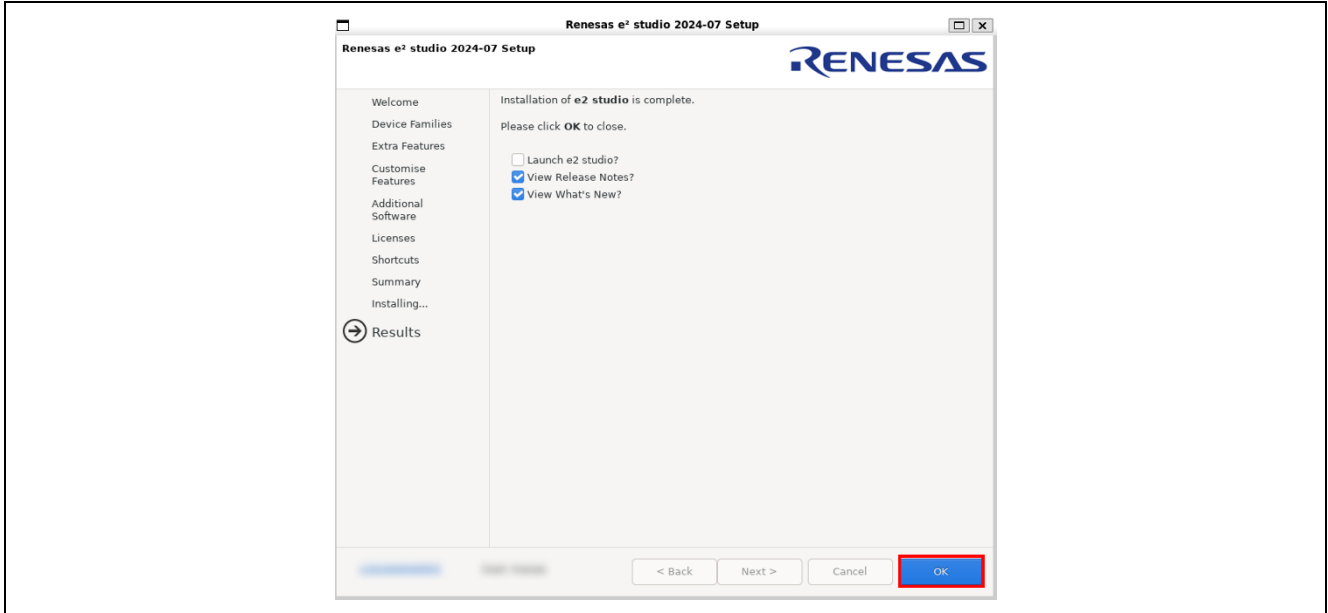

Figure 11: Summary Page

2.2 FSP setup

In this section, 3 ways of FSP installation are described. However, at this moment, platform installer won't be available and so, please install FSP based on either 2.2.2 or 2.2.3.

2.2.1 Installation of FSP Packs using Platform Installer

This section describes how to install FSP using Platform Installer `setup_rzafsp_v3_1_0_e2s_v2024-07.exe` showcased at [here](#).

1. Double-click `setup_rzafsp_v3_1_0_e2s_v2024-07.exe`, select either **[Quick Install]** or **[Custom Install]** and click **[Next >]** when the installation wizard is shown. When you chose **[Quick Install]**, you can jump to 6. Licenses.

Note:

If e2 studio was installed in your PC, the option to upgrade the existing version or install e2 studio to a different location will be displayed.

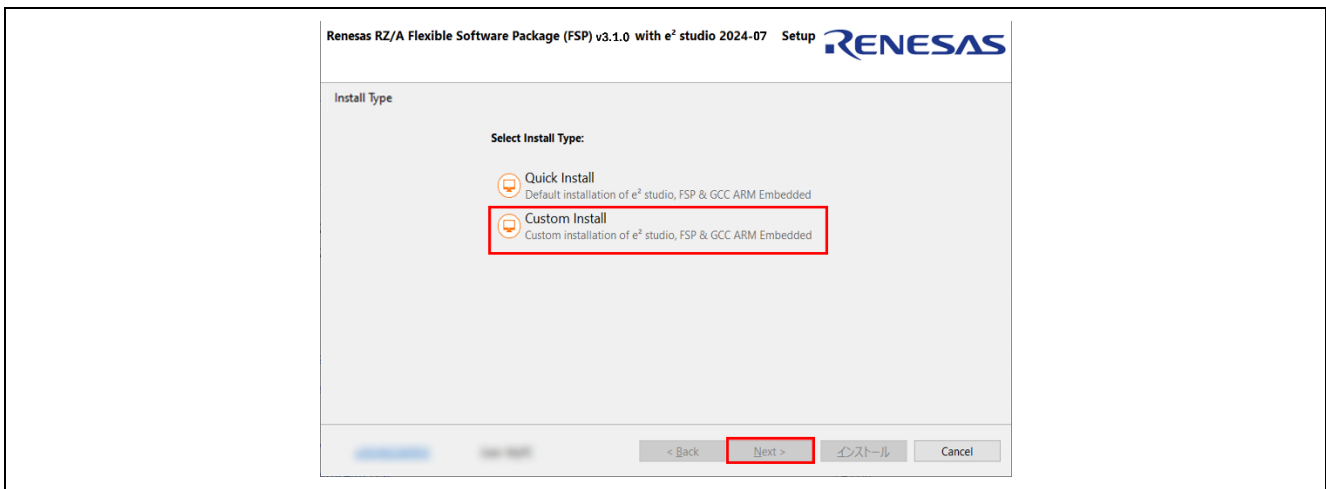

Figure 7: FSP Platform Installation Wizard

2. Welcome page

User can change the install folder by clicking **[Change...]**. Click **[Next]** to continue.

Note:

1. If you would like to have multiple versions of e2 studio, please specify new folder here.
2. Multi-byte characters cannot be used for e2 studio installation folder name.

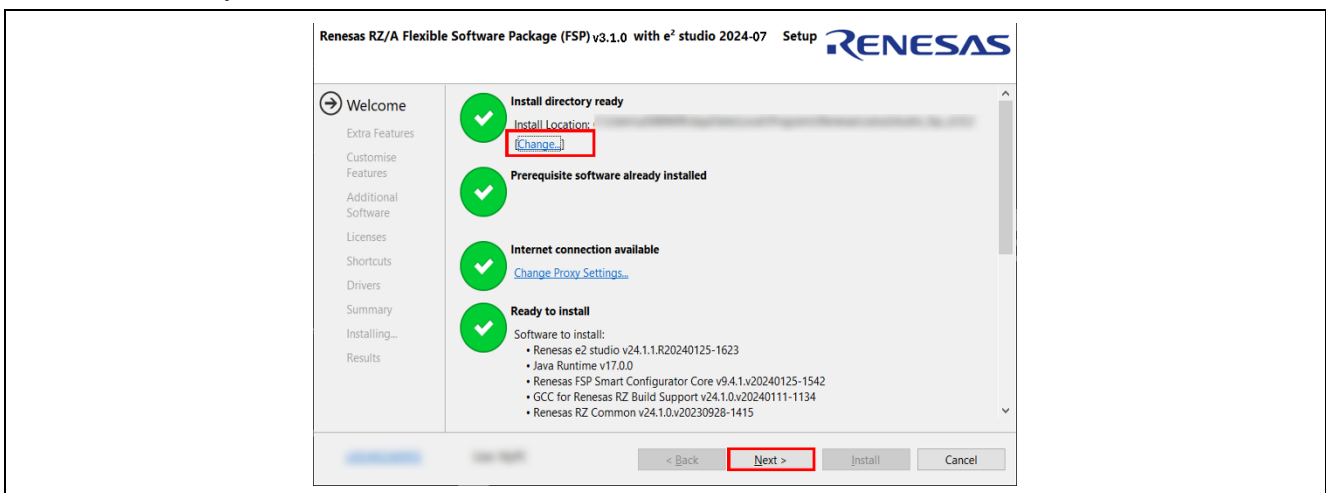

Figure 8: FSP Platform Installer – Welcome page

3. Extra Features

Select Extra Features (i.e., Language packs, SVN & Git support, RTOS support...) to be installed. For non-English language users, please select Language packs at this step if needed. Then, click the [Next] button to continue.

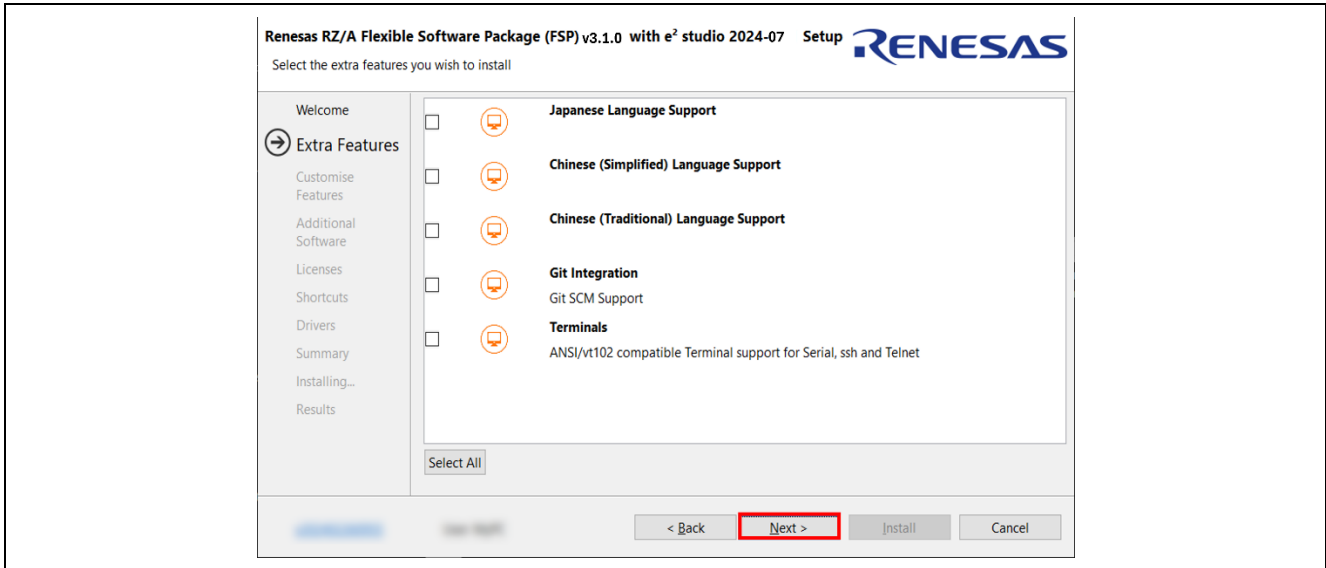

Figure 9: FSP Platform Installer – Extra Features

4. Customize Features

Essential features have already been selected. If you would like to install additional features, please check those and then click [Next >].

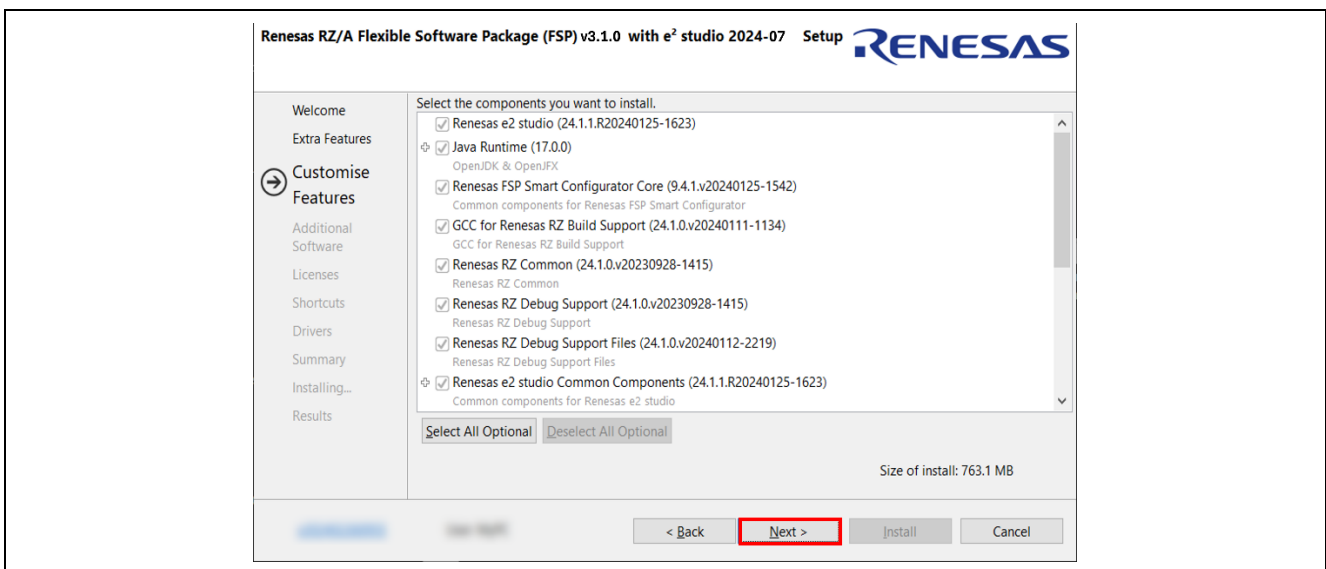

Figure 10: FSP Platform Installer – Features

5. Additional Software

All the software is selected by default. click [Next >].

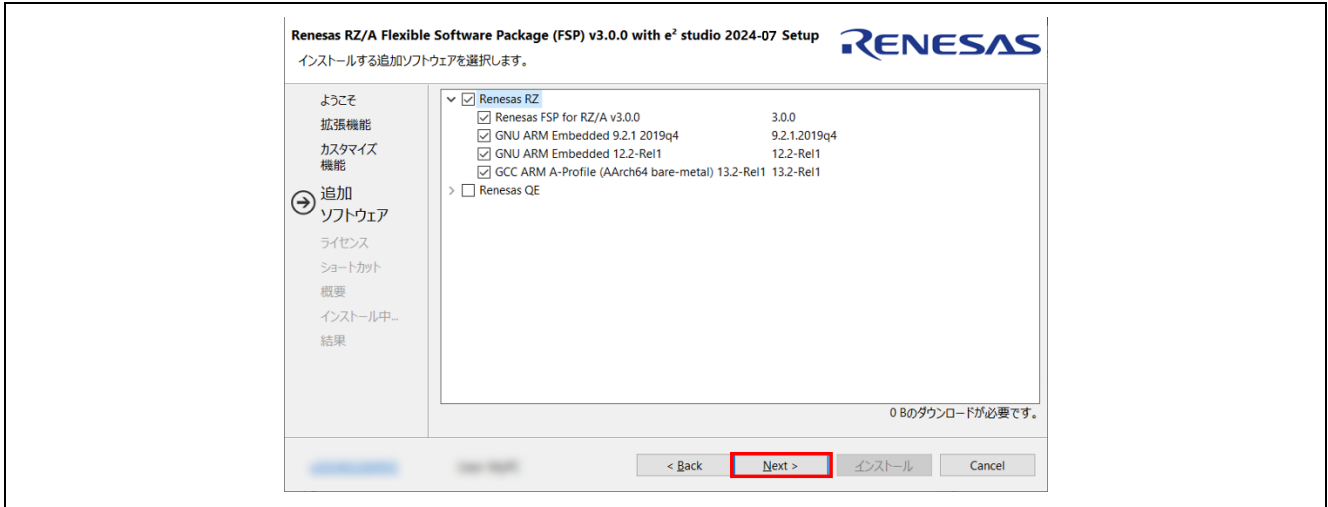

Figure 11: FSP Platform Installer – Additional Software

6. Licenses

Please read and accept Software License Agreements to be listed and click [Next >].

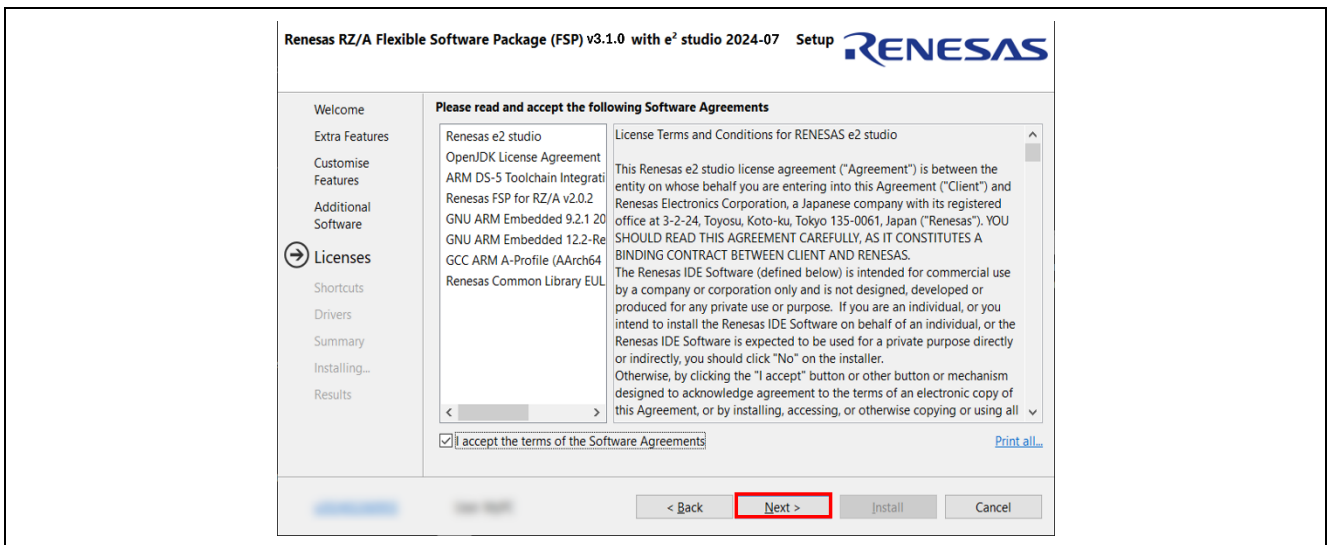

Figure 12: FSP Platform Installer – Licenses

7. Shortcuts

Select shortcut name for start menu and click [Next] button to continue.

Note:

If e2 studio was installed in another location, it is recommended to rename it to distinguish from the other e2 studio(s).

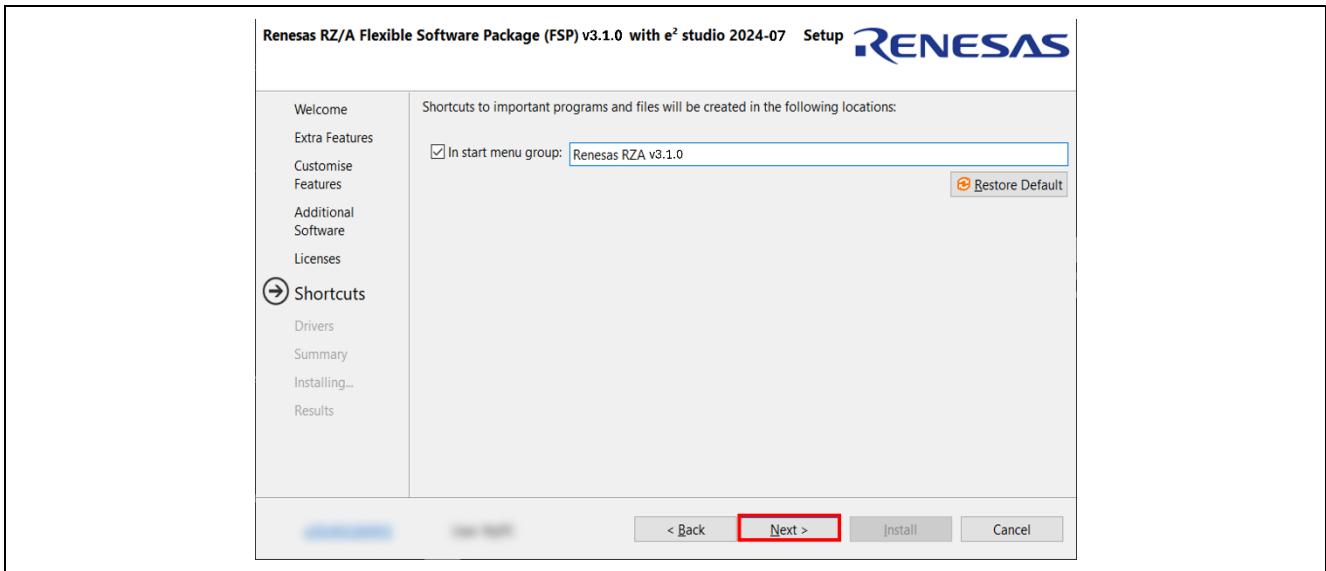

Figure 13: FSP Platform Installer – Shortcuts

8. Summary

Components list to be installed is shown. Please confirm the contents and click the [Install] button to install the Renesas e2 studio IDE.

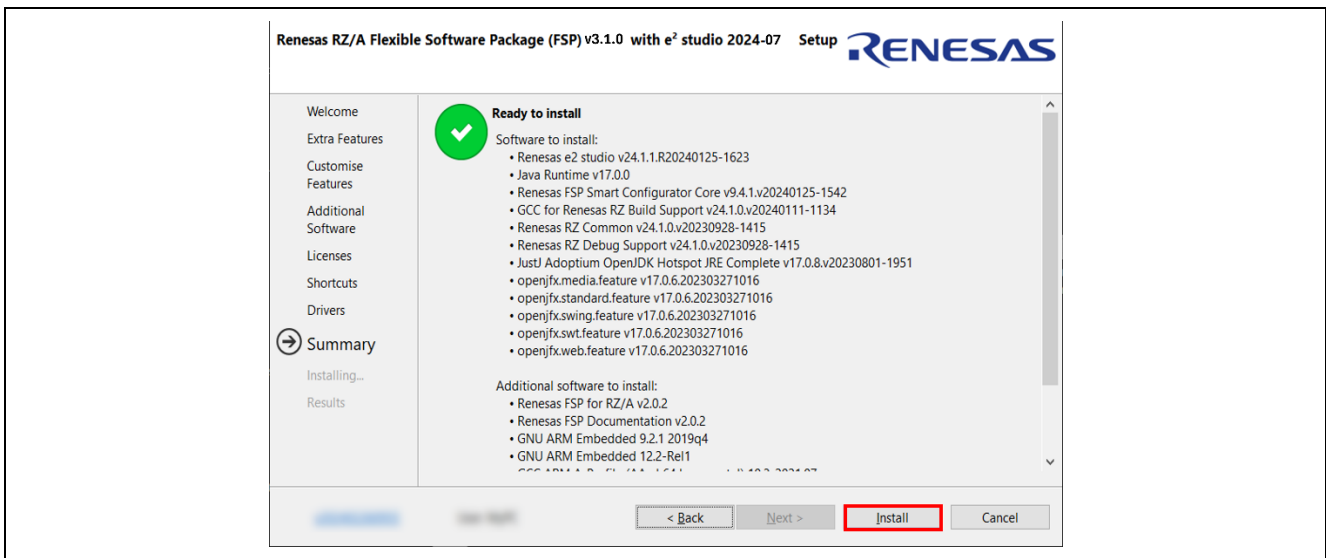

Figure 14: FSP Platform Installer – Summary

10. Installing...

The installation is performed. Depending on selected items of additional software, new dialog prompts may appear during the installation process. At that time, please follow the instruction the installer indicates.

11. Results

If the installation is successfully done, you should see the following information.

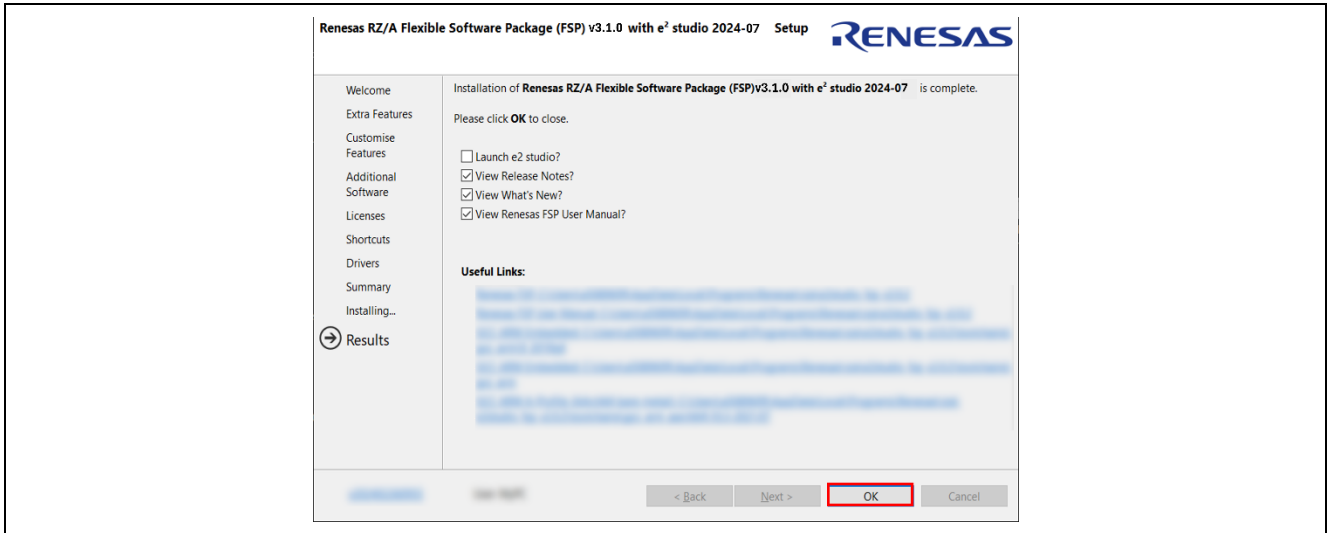

Figure 15: Installation Results of FSP Platform Installer

2.2.2 Installation of FSP Packs using Package Installer

Package Installer **RZA_FSP_Packs_v3.1.0.exe** is showcased at [here](#). Please note that it's for Windows Host PC only.

Here is the procedure:

1. Exit e2 studio.
2. Invoke **RZA_FSP_Packs_v3.1.0.exe**.
3. Click [Next >] to start the installation.

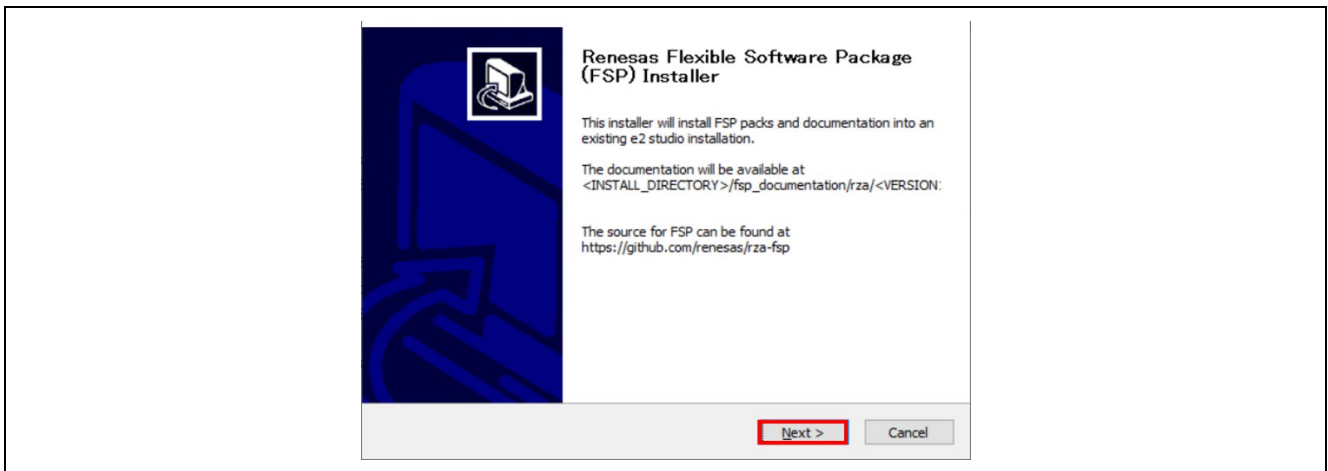

Figure 16: FSP Package Installer

4. See the license term and click [I Agree] if it's acceptable

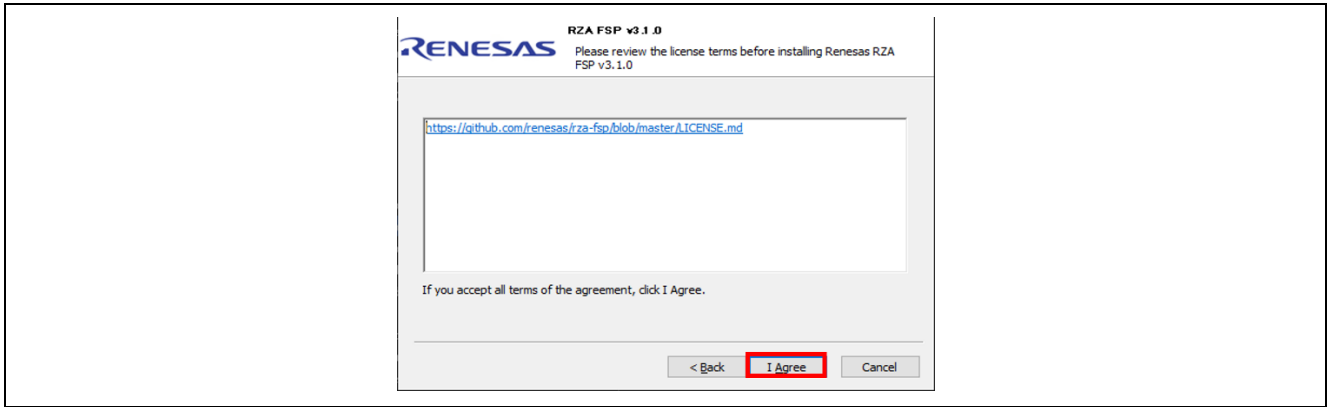

Figure 17: FSP License Term

5. Specify e2 studio installation folder (e.g., C:\Renesas\e2studio) and click [Install].

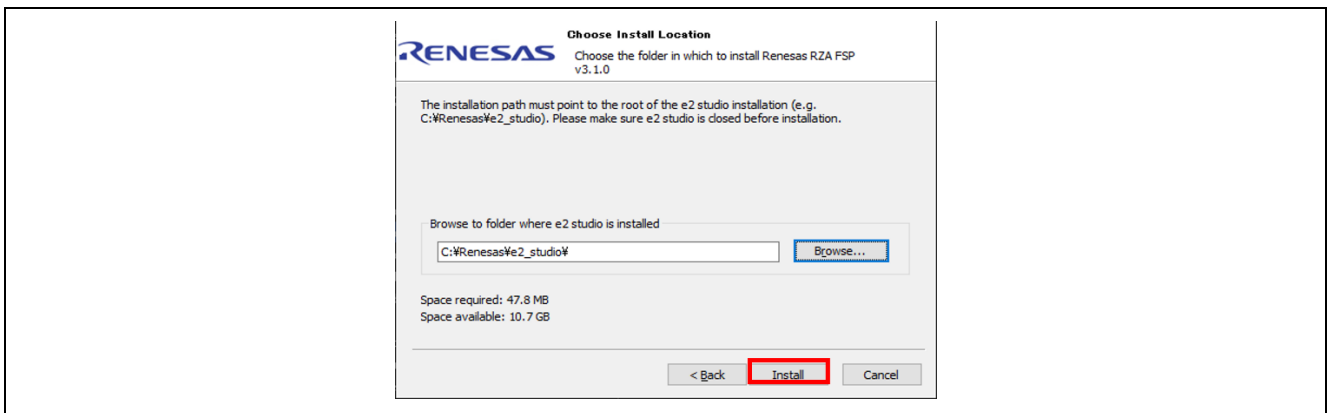

Figure 18: FSP Installation

6. Click [Finish] to complete the installation.

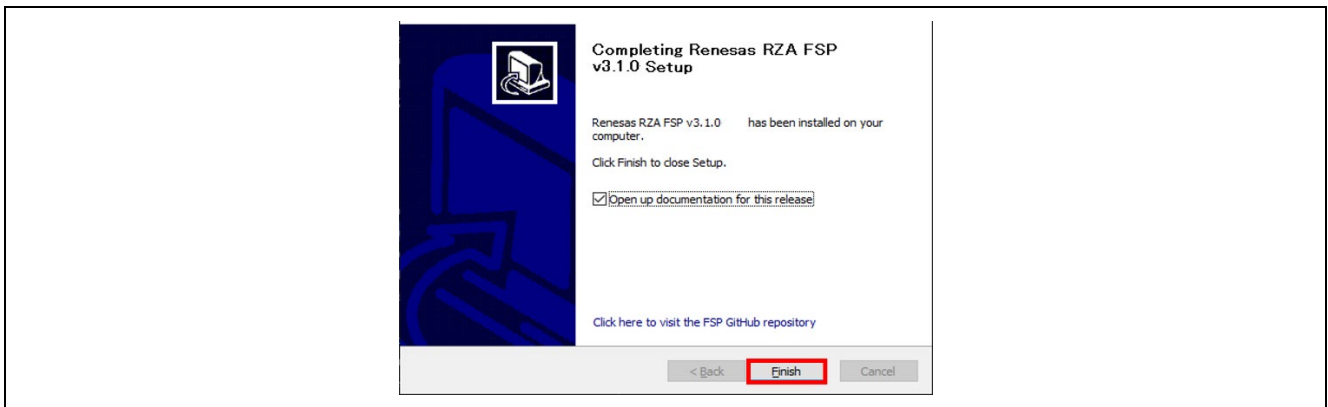

Figure 19: Completion of FSP Installation

If the box **Open up documentation for this release** is checked at that time, FSP documentation for the installed version of FSP should be opened.

2.2.3 Installation of FSP Packs using Package Zip file

No Package installer is available for Linux Host PC and therefore, you need to install FSP Packs with **RZA_FSP_Packs_v3.1.0.zip**. This section describes how to do install it. Please note that the same installation procedure is valid for Windows Host PC.

1. Download **RZA_FSP_Packs_v3.1.0.zip** from [here](#).
2. Extract the zip file to e² studio installation directory.

If the FSP Packs are successfully extracted, **rz_fsp/rza/packs** directory is placed at the location below:

- **<e² studio installation directory>/internal/projectgen**

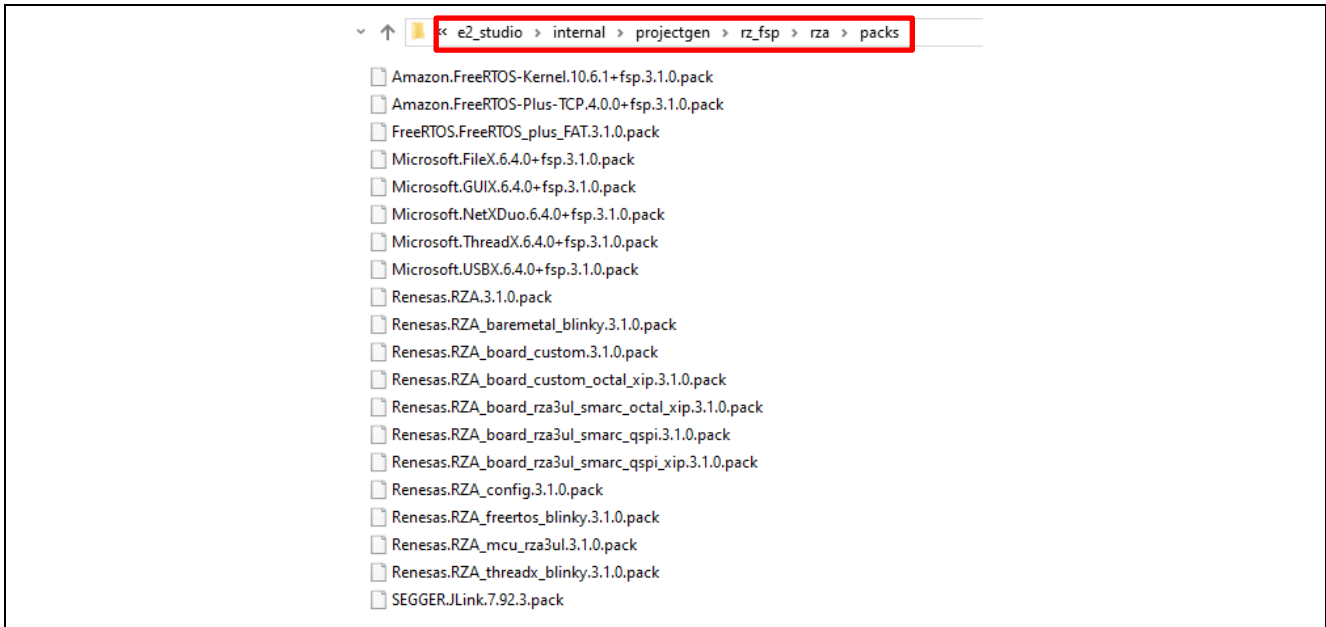
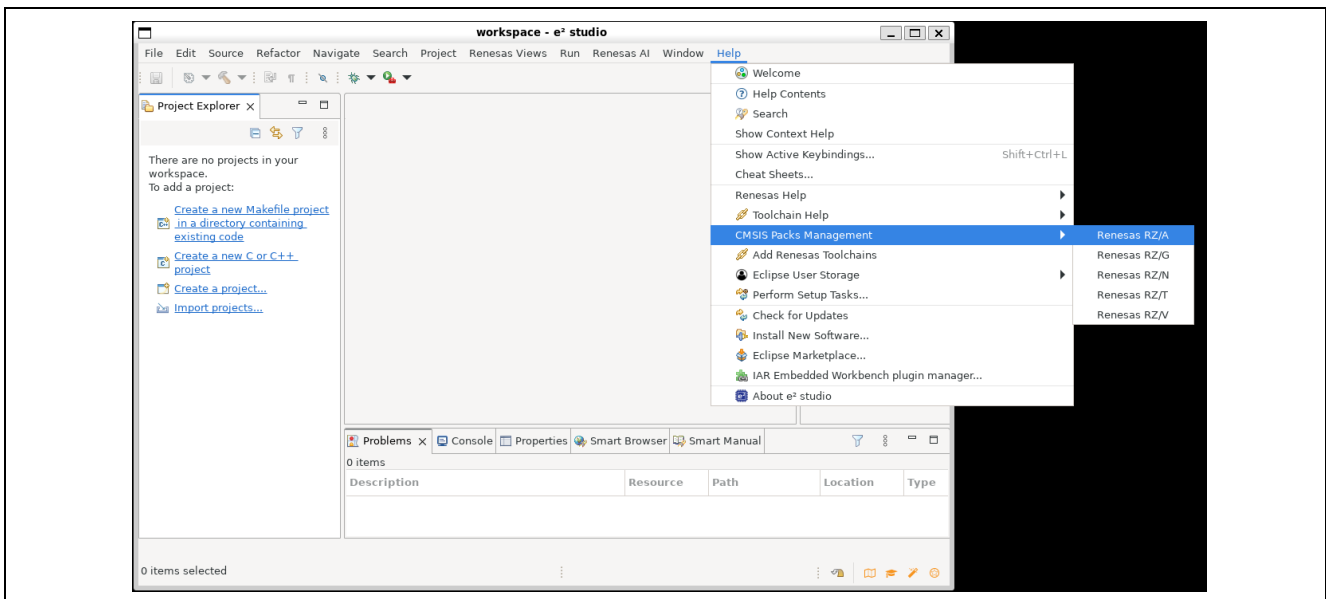
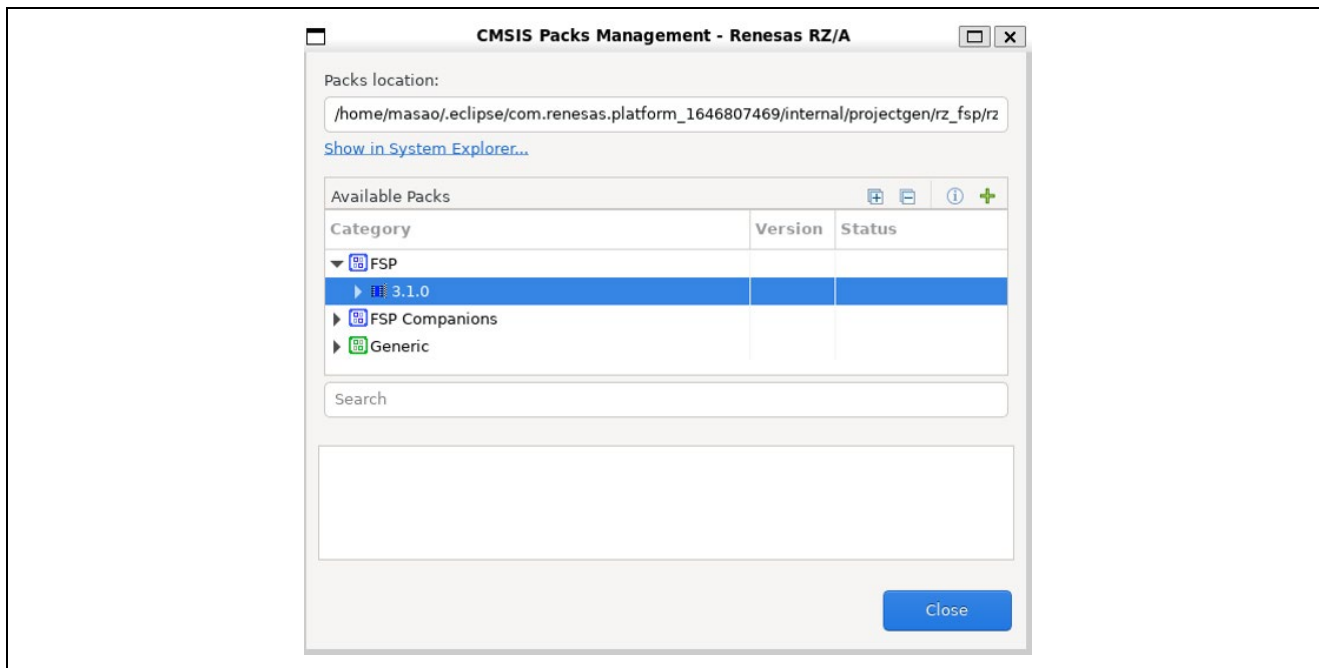

Figure 33. FSP Packs in e2 studio installation directory

3. At the 1st invocation of e² studio after you carry out the above procedure, FSP Packs should be installed automatically.
4. You can check if the installation is successfully done by the following procedure:
Click **Help > CMSIS Packs Management > Renesas RZ/A**.



If FSP is successfully installed, 3.1.0 should be listed under FSP as shown below:



3. Set up an SMARC EVK

Below is an example of a typical system configuration.

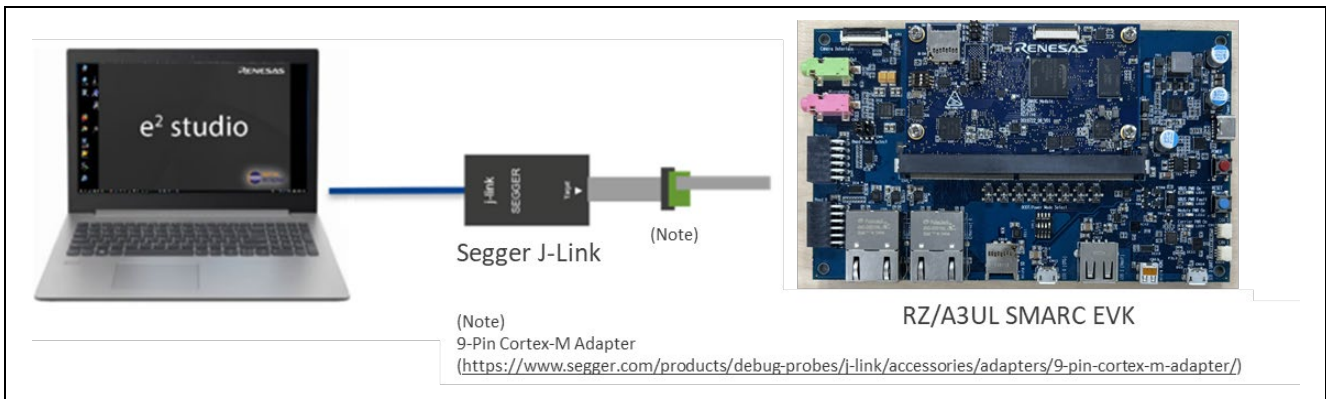

Figure 20: System Configuration Example – SMARC EVK

3.1 Supported Debugger

- SEGGER J-Link

For details on SEGGER J-Link, please see [J-Link Debug Probes by SEGGER – the Embedded Experts](https://www.segger.com/products/debug-probes/j-link/).

3.2 Board Setup

3.2.1 Boot Mode

Set up the SW11 as follows to configure Boot Mode 3 (QSPI or OCTA Boot (1.8V) Mode)/

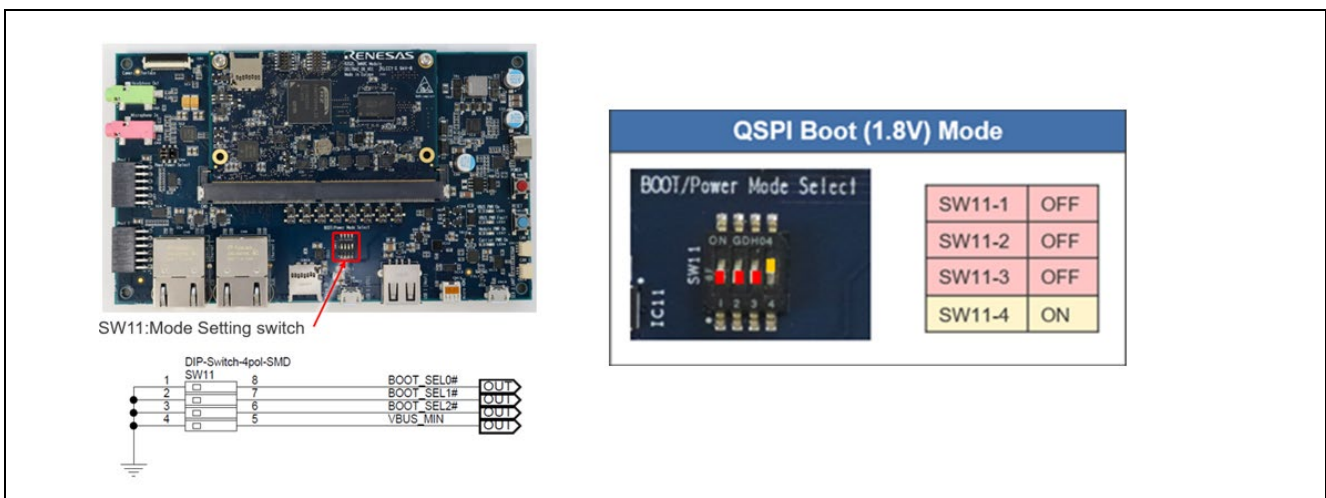

Figure 21: Boot MODE

3.2.2 JTAG connection

When connecting JTAG, you must set the DIP SW1 settings as follows:

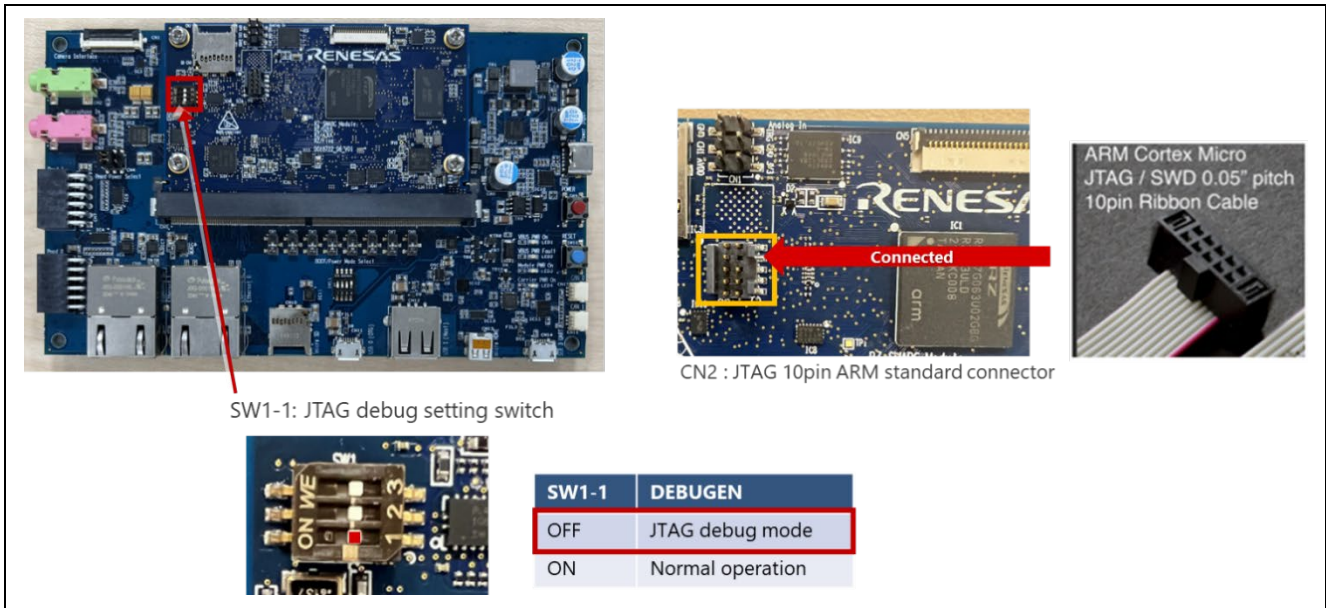

Figure 22: JTAG connection

Please note that RZ/A3UL SMARC EVK has CoreSight 10 connector and therefore, the following adapter must be needed to connect Segger J-Link.

<https://www.segger.com/products/debug-probes/j-link/accessories/adapters/9-pin-cortex-m-adapter/>

3.2.3 Debug Serial (console output)

Debug serial uses CN14. The baud rate is 115200bps.

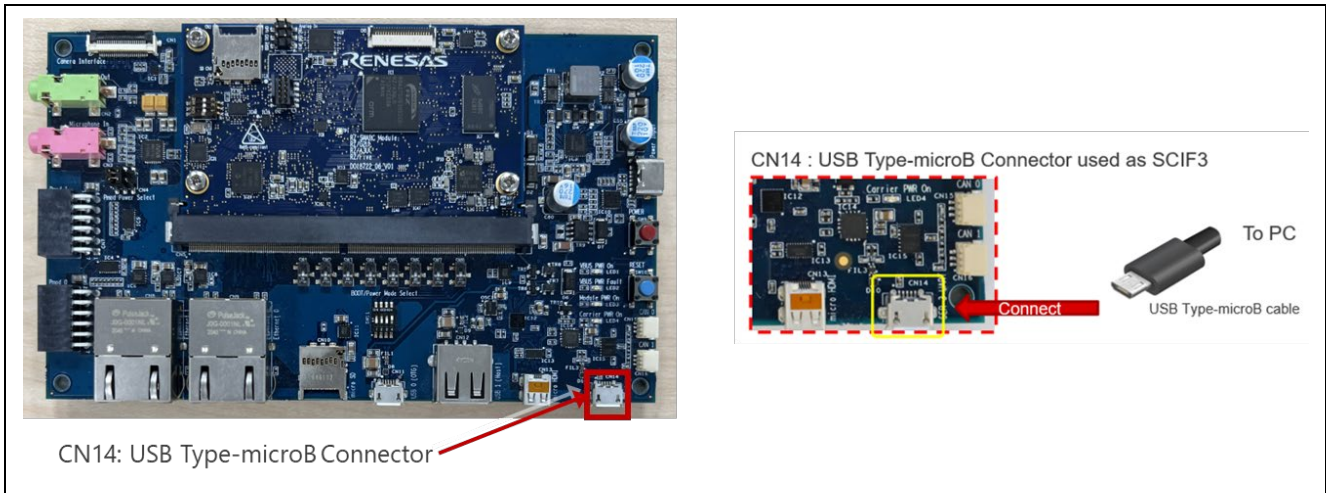

Figure 23: Debug Serial (console output)

3.2.4 Power Supply

Here are the proven power supply related goods to be used in Renesas' development. Please prepare for the equivalent ones for your development.

- USB Type-C cable CB-CD23BK (manufactured by Aukey)
- USB PD Charger Anker PowerPort III 65W Pod (manufactured by Anker)

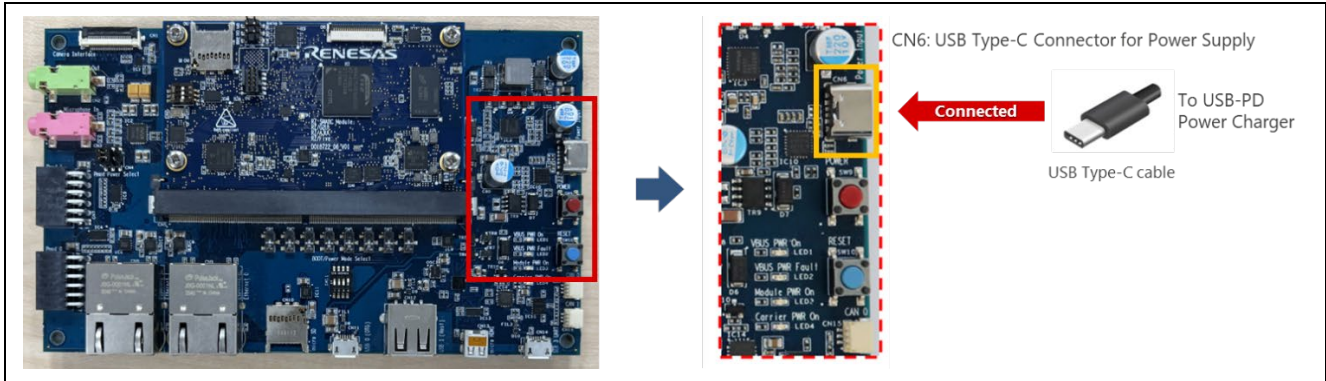

Figure 24: Power Supply

For power supply, please follow the following procedure:

1. Connect USB-PD Power Charger to USB Type-C Connector (CN6).
Once USB-PD Power Charger is connected to the CN6, LED1 (VBUS PWR ON) and LED3 (Module PWR ON) should light up.
2. Press the power button (SW9) to turn on the power
When turning on the power, you need to press and hold the power button for 1 second. Also, the power button should be pressed and held for 2 seconds for turning off the power.
3. If the power supply is successful, LED4 (Carrier PWR On) should light up.

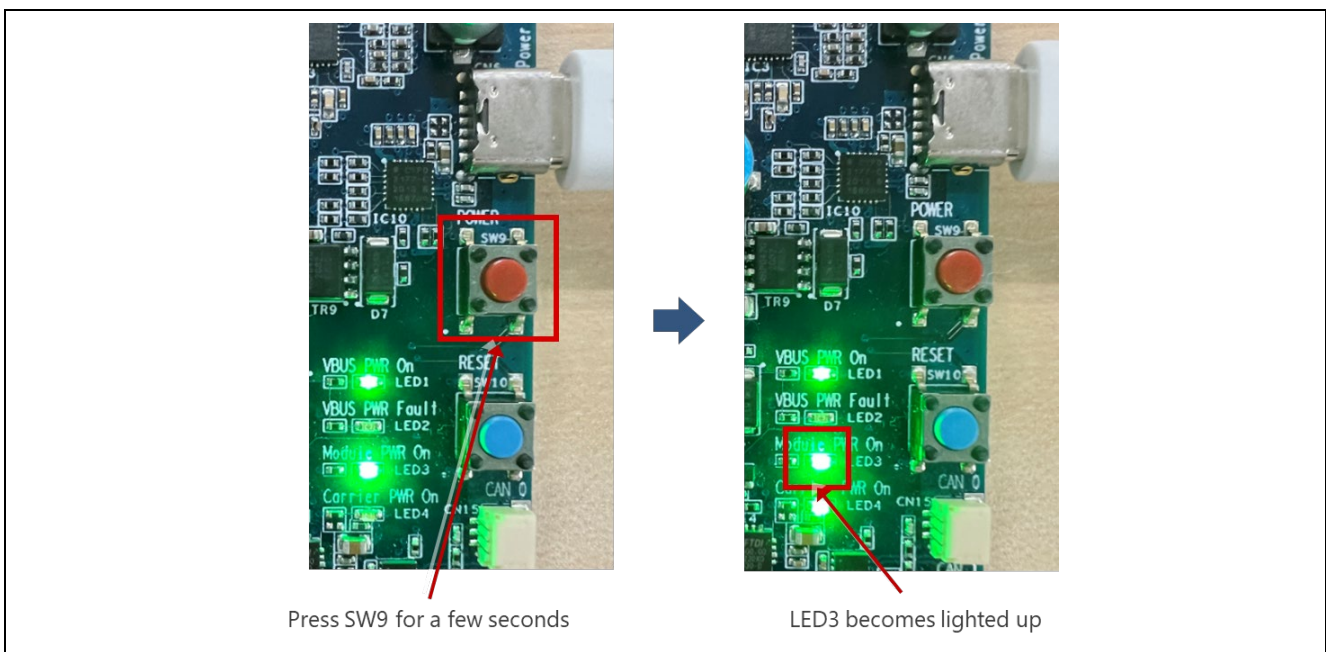

Figure 25: LED Status after Turning on EVK

3.2.5 How to check if your board is operational

This section describes how to check if your board is operational.

1. Connect the board to your development PC as described in 3.2.3.
2. Turn on the board as described in 3.2.4.
3. Launch Terminal Software (e.g., Tera Term).
4. Establish the connection between the board and development PC as shown in figure below:

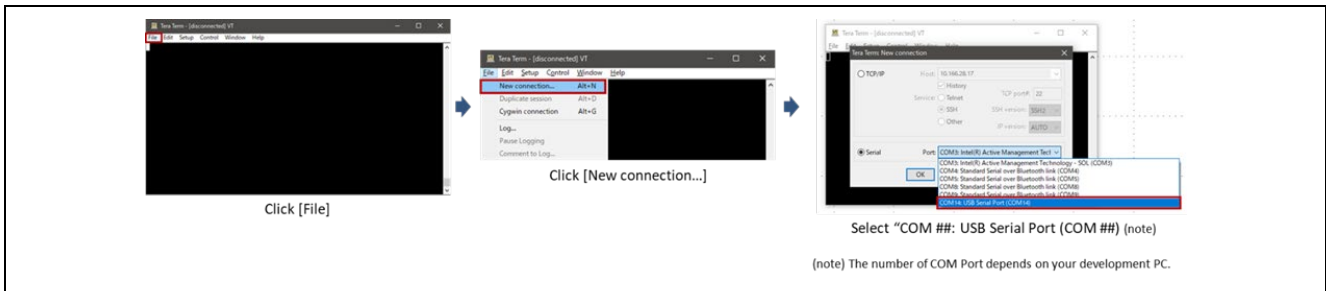

Figure 26: Establishment of connection between EVK and Development PC

5. You should see the following message on your Terminal Software. You can ignore the keyword “error” since the cause of error is that nothing is programmed to QSPI Flash or OctaFlash by default.

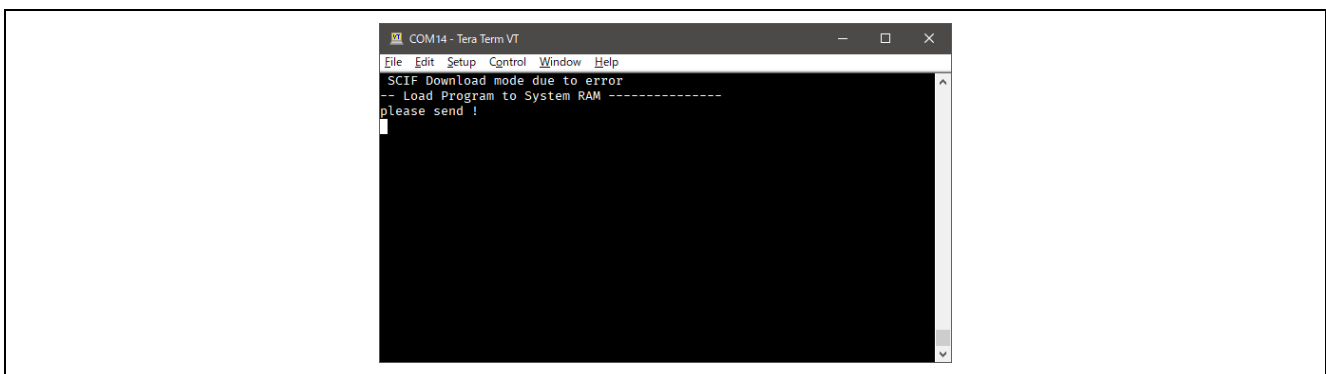

Figure 27: Message on your terminal at the 1st power-up of EVK

4. Tutorial: Your First RZ MPU Project - Blinky

4.1 Tutorial Blinky

The goal of this tutorial is to quickly get acquainted with the Flexible Platform by moving through the steps of creating a simple application using e2 studio and running that application on an RZ MPU board.

4.2 What Does Blinky Do?

The application used in this tutorial is Blinky, traditionally the first program run in a new embedded development environment.

Blinky is the "Hello World" of microprocessors. If the LED blinks you know that:

- The toolchain is setup correctly and builds a working executable image for your chip.
- The debugger has installed with working drivers and is properly connected to the board.
- The board is powered up and its jumper and switch settings are probably correct.
- The microprocessor is alive, the clocks are running, and the memory is initialized.
- Timer (GTM) interrupt is intentionally fired and GPIO is properly controlled.

Note:

SRMAC EVK board does not have any LED. Thus, Blinky sample application used in this tutorial is designed to use the Pmod module described below alternatively:

- Pmod LED (Four High-brightness LEDs):
<https://reference.digilentinc.com/pmod/pmodled/start>

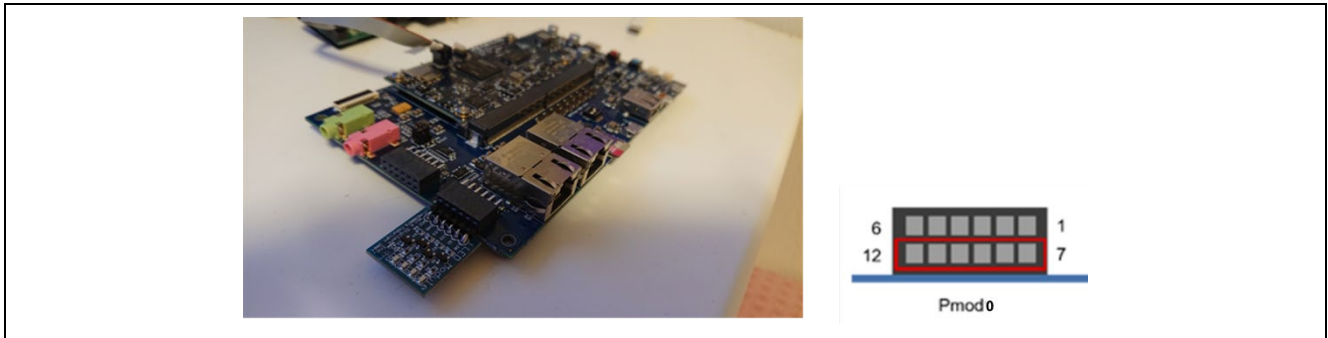

Figure 28: Connection Pmod LED module (410-076)

This module is not included on the SRMAC EVK board and so, please prepare it beforehand.

4.3 Create a New Project for Blinky

The creation and configuration of an RZ/A C/C++ FSP Project is the first step in the creation of an application. The base RZ/A pack includes a pre-written Blinky example application.

Follow these steps to create an RZ MPU project:

1. In e2 studio, click [File] > [New] > [C/C++ Project].

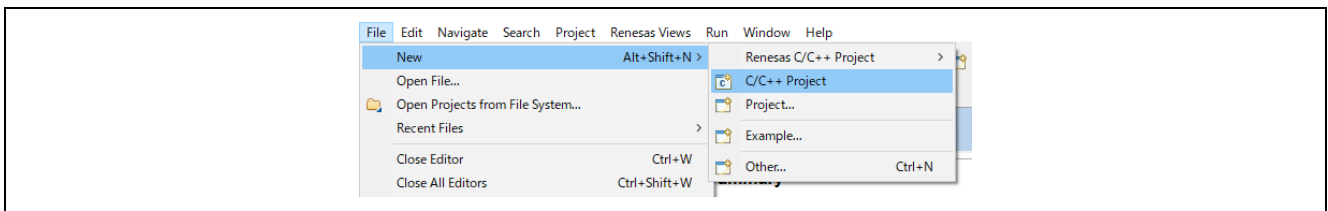

Figure 29: New C/C++ Project

2. Select [Renesas RZ] > [Renesas RZ/A C/C++ FSP Project] and Click Next.

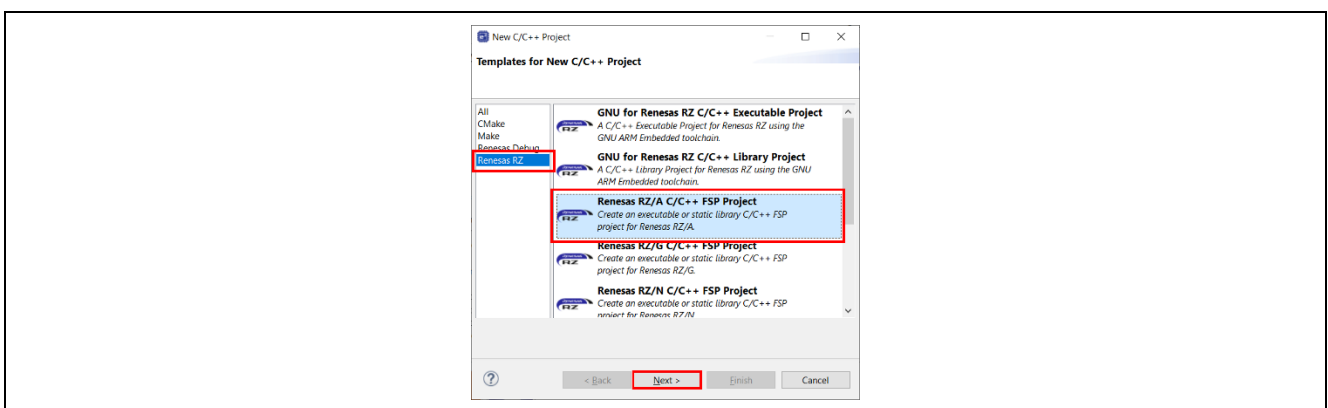

Figure 30: Renesas RZ/A C/C++ FSP Project

3. Assign a name to this new project. Blinky is a good name to use for this tutorial.
4. Click **Next**. The **Project Configuration** window shows your selection.

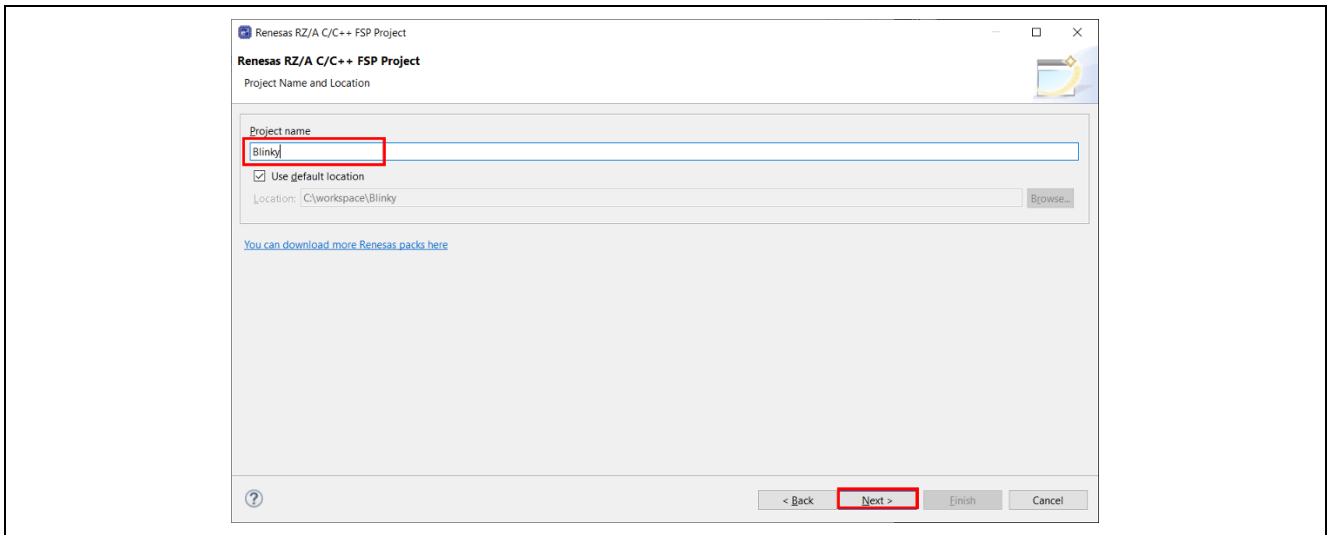

Figure 31 : e2 studio Project Configuration window (part 1)

5. Select the board support package corresponding to the package you would like to use, GNU ARM A-Profile (AArch64 bare-metal) and 13.2.1 from the Device Selection drop-down list, Toolchains and Version Selection drop-down list respectively. Then, Click [Next].

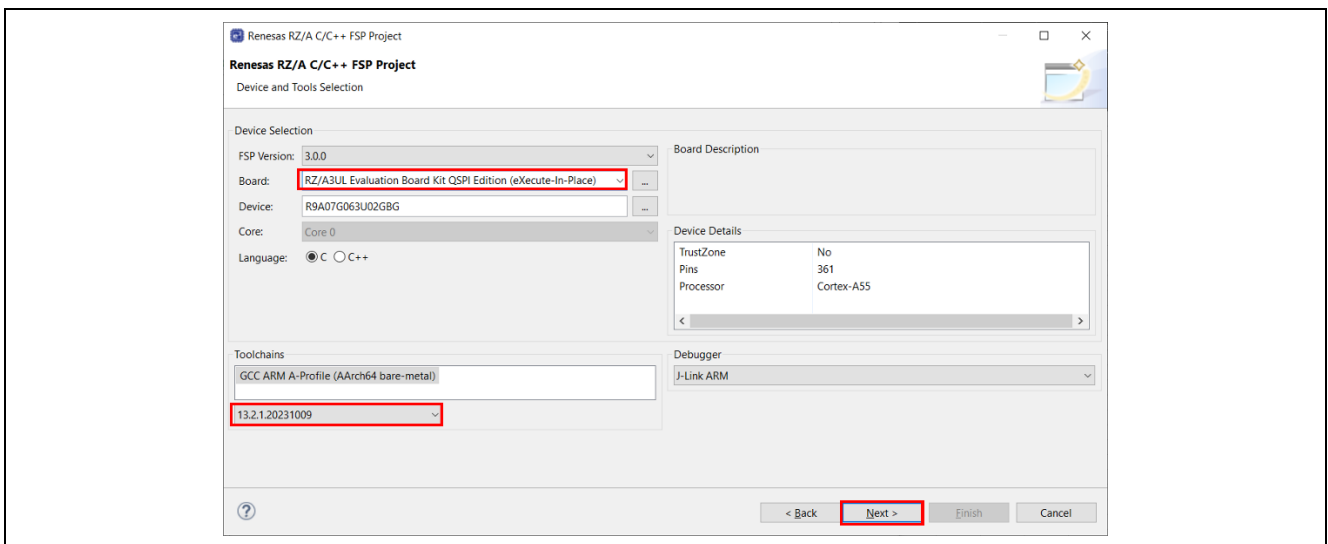

Figure 32 : e2 studio Project Configuration window (part 2)

6. Select the **Build Artifact** and **RTOS**.

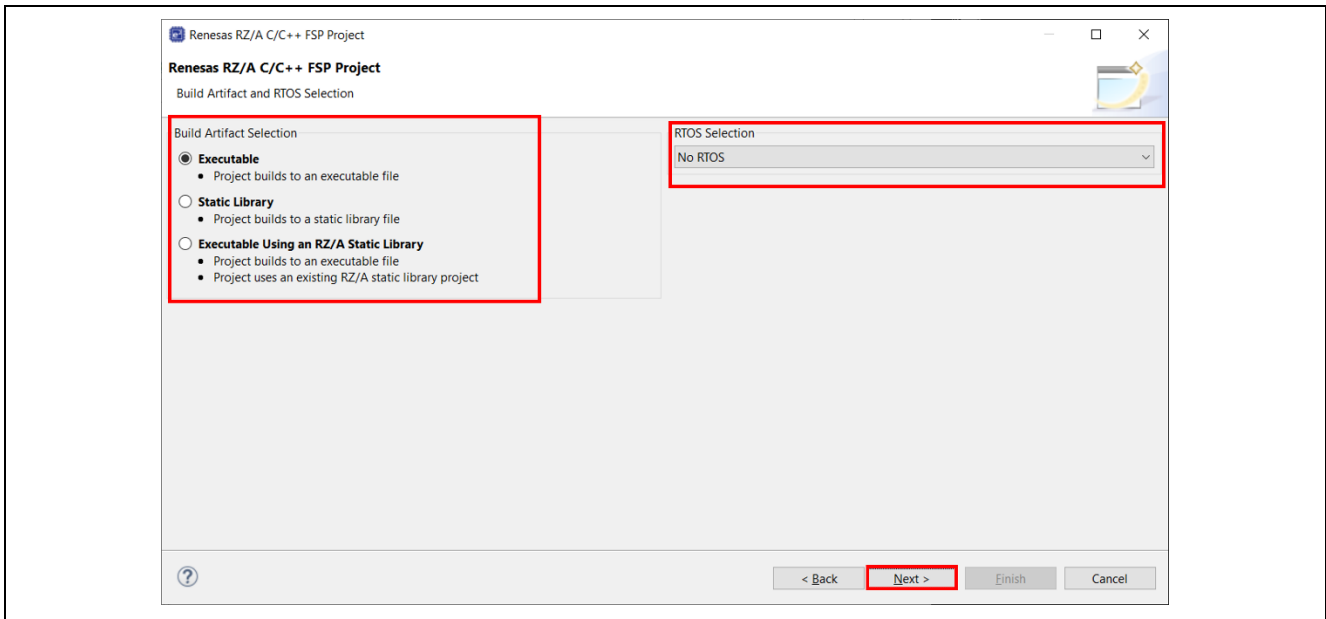

Figure 33 : e2 studio Project Configuration window (part 3)

7. Select the **Blinky** template for your board and click **Finish**.

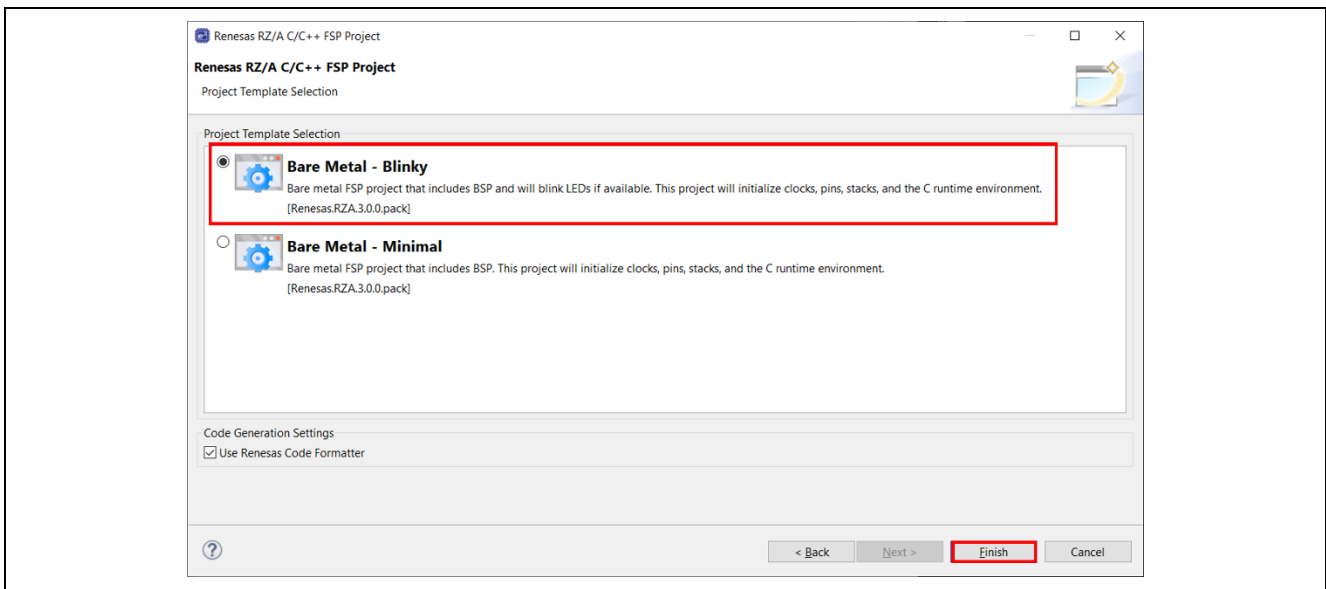

Figure 34 : e2 studio Project Configuration window (part 4)

Once the project has been created, the name of the project will show up in the **Project Explorer** window of e2 studio. Now click the **Generate Project Content** button in the top right corner of the **Project Configuration** window to generate your board specific files.

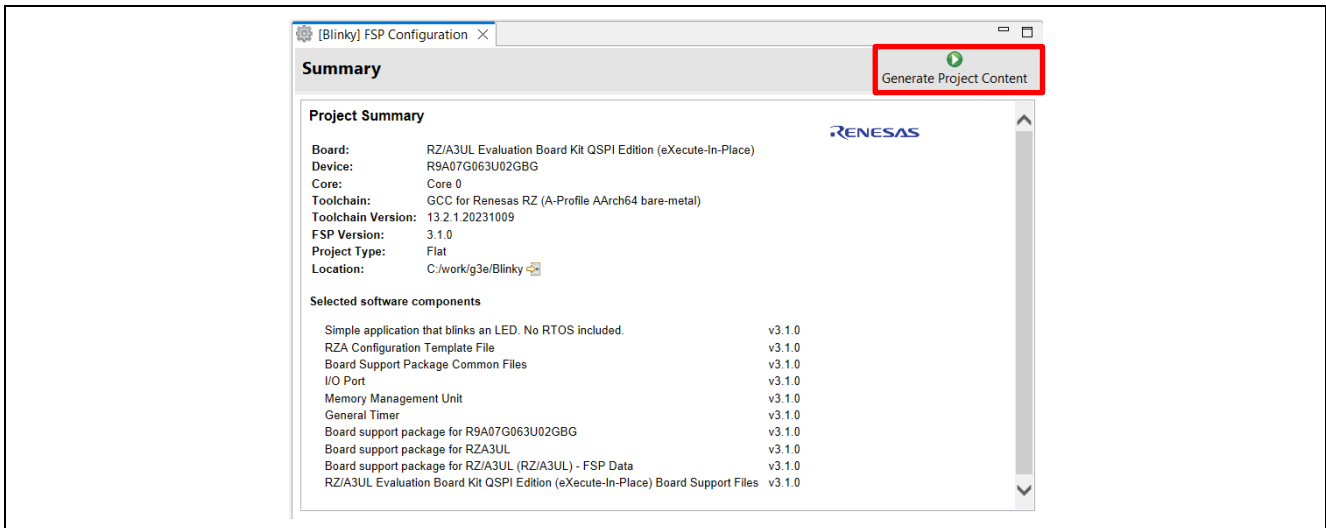

Figure 35 : e2 studio Project Configuration tab

Your new project is now created, configured, and ready to build.

4.3.1 Details about the Blinky Configuration

The Generate Project Content button creates configuration header files, copies source files from templates, and generally configures the project based on the state of the Project Configuration screen.

For example, if you check a box next to a module in the Components tab and click the Generate Project Content button, all the files necessary for the inclusion of that module into the project will be copied or created. If that same check box is then unchecked those files will be deleted.

4.3.2 Configuring the Blinky Clocks

By selecting the Blinky template, the clocks are configured by e2 studio for the Blinky application. The clock configuration tab (see 5.2.3. Configuring Clocks) shows the Blinky clock configuration. The Blinky clock configuration is stored in the BSP clock configuration file.

4.3.3 Configuring the Blinky Pins

By selecting the Blinky template, the GPIO pins used to toggle the LED1 are configured by e2 studio for the Blinky application. The pin configuration tab shows the pin configuration for the Blinky application (see 5.2.4. Configuring Pins). The Blinky pin configuration is stored in the BSP configuration file.

4.3.4 Configuring the Parameters for Blinky Components

The Blinky project automatically selects the following HAL components in the Components tab:

- r_gtm
- r_ioport
- r_mmu

To see the configuration parameters for any of the components, check the Properties tab in the HAL window for the respective driver (see 5.2.9. Adding and Configuring HAL Drivers).

4.3.5 Where is main()?

The main function is located in <project>/rza_gen/main.c. It is one of the files that are generated during the project creation stage and only contains a call to hal_entry(). For more information on generated files, see Adding and Configuring HAL Drivers.

4.3.6 Blinky Example Code

The blinky application is stored in the `hal_entry.c` file. This file is generated by e2 studio when you select the Blinky Project template and is located in the project's `src/` folder.

The application performs the following steps:

1. Get the LED information for the selected board by `bsp_leds_t` structure.
2. Set the configuration of Timer (GTM) and the callback function that is called when interrupt is fired.
3. Define the output level HIGH for the GPIO pins controlling the LEDs for the selected board.
4. Toggle the LEDs by calling "`R_BSP_PinWrite((bsp_io_port_pin_t) pin, pin_level)`" for writing to the GPIO pin in callback function of GTM that is called with the specified interval.

4.4 Build the Blinky Project

Highlight the new project in the Project Explorer window by clicking on it and build it. There are three ways to build a project:

1. Click on Project in the menu bar and select Build Project.
2. Click on the hammer icon.
3. Right-click on the project and select Build Project.

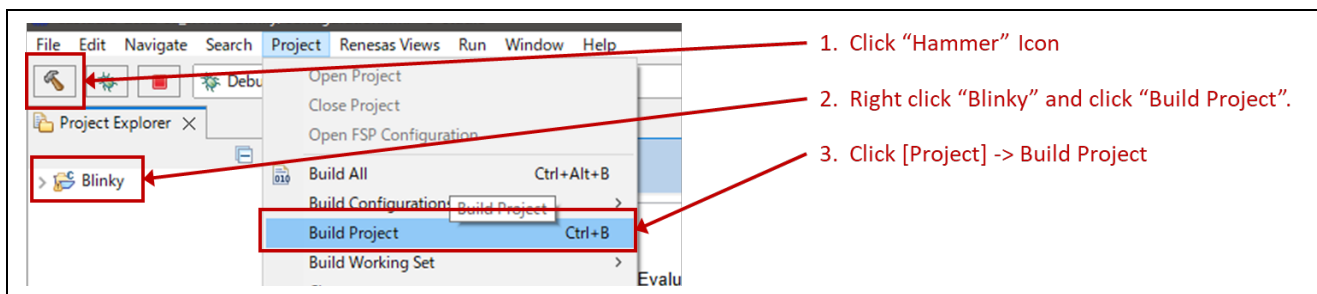

Figure 36 : e2 studio Project Explorer window

Once the build is completed, a message shown below is displayed in the build Console window that displays the final image file name and section sizes in that image:

```

../rza/fsp/src/bsp/cmsis/Device/RENESAS/Source/program_entry.asm
../rza/fsp/src/bsp/cmsis/Device/RENESAS/Source/startup.asm
Building file: ../rza/fsp/src/bsp/cmsis/Device/RENESAS/Source/system.c
../rza/fsp/src/bsp/cmsis/Device/RENESAS/Source/system.c
Building file: ../rza/fsp/src/bsp/cmsis/Device/RENESAS/Source/vector_table.asm
Building file: ../rza/board/rza3ul_smarc_qspi_xip/board_init.c
Building file: ../rza/board/rza3ul_smarc_qspi_xip/board_leds.c
../rza/fsp/src/bsp/cmsis/Device/RENESAS/Source/vector_table.asm
../rza/board/rza3ul_smarc_qspi_xip/board_init.c
../rza/board/rza3ul_smarc_qspi_xip/board_leds.c
Building target: Blinky.elf
aarch64-none-elf-objcopy -O ihex "Blinky.elf" "Blinky.hex"
aarch64-none-elf-size --format=berkeley "Blinky.elf"
text  data  bss  dec  hex filename
11924  6736 2164980 2183640 2151d8 Blinky.elf

19:52:34 Build Finished. 0 errors, 0 warnings. (took 6s.813ms)

```

Figure 37 : e2 studio Project Build console

4.5 Debug the Blinky Project

4.5.1 Debug prerequisites

To debug the project on a board, you need

- The board to be connected to e2 studio
- The debugger to be configured to talk to the board
- The application to be programmed to the microprocessor

Applications run from the internal ram or external ram of your microprocessor. To run or debug the application, the application must first be programmed to ram by JTAG debugger. SMARC EVK board has an JTAG header and requires an external JTAG debugger to the header.

4.5.2 Debug steps

To debug the Blinky application, follow these steps:

1. Configure the debugger for your project by clicking [Run] > [Debugger Configurations...].

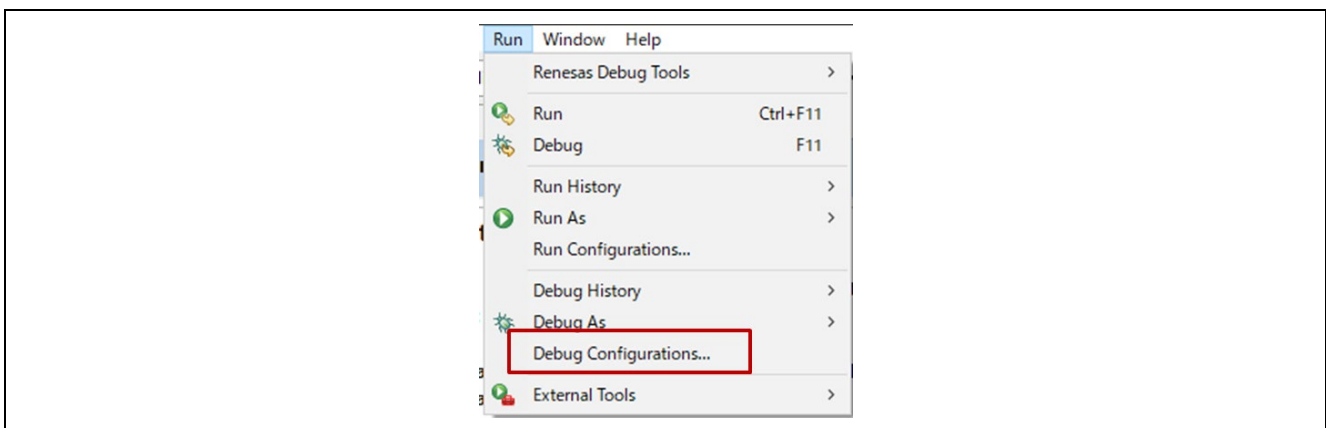

Figure 38 : e2 studio Debug icon

or by selecting the drop-down menu next to the bug icon and selecting [Debug Configurations...].

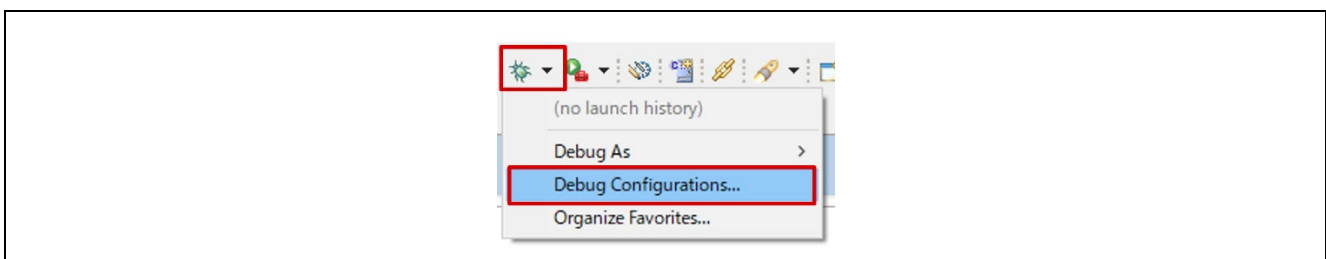

Figure 39 : e2 studio Debugger Configurations selection option

2. Select your debugger configuration in the window. If it is not visible, then it must be created by clicking the “New” icon in the top left corner of the window. Once selected, the **Debug configuration** for your **Blinky** project should be displayed.

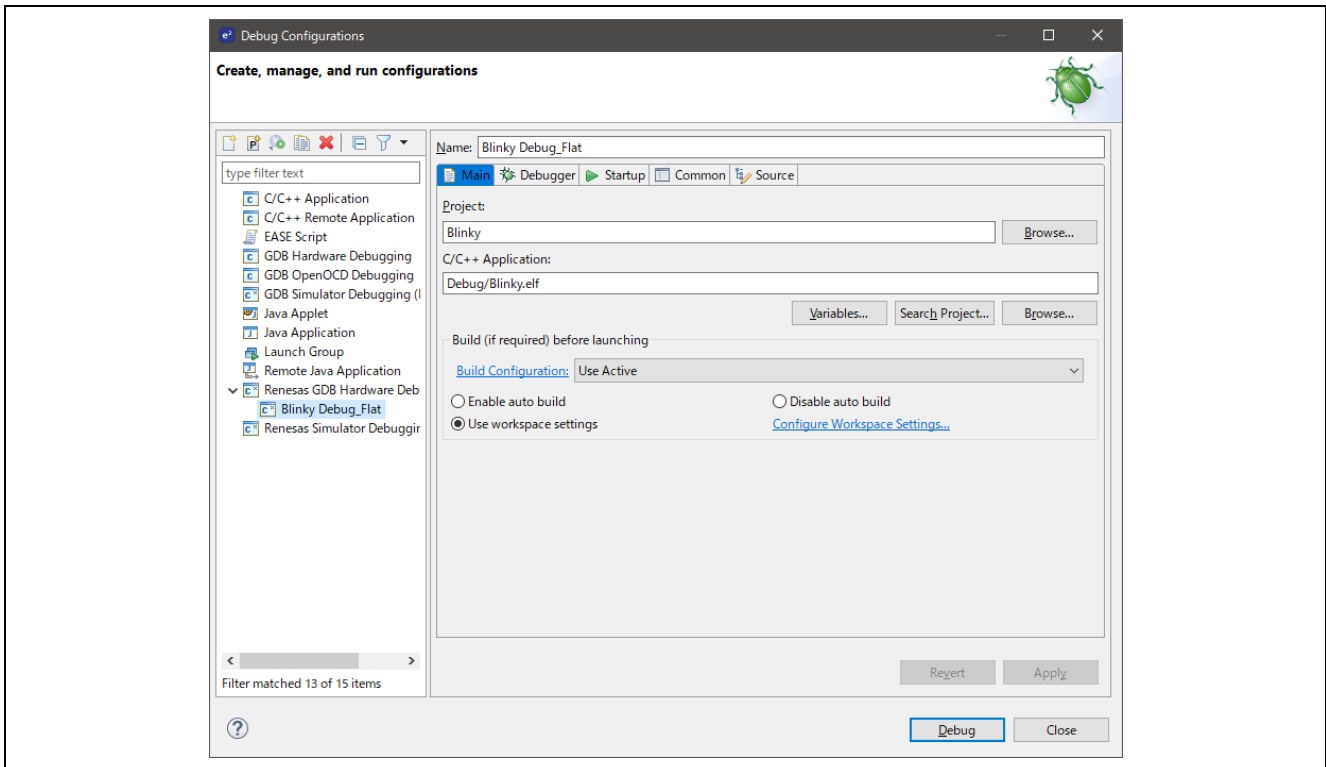

Figure 40 : e2 studio Debugger Configurations window with Blinky project (1)

3. Select the debug configuration for the generated project and select the **Debugger** tab.

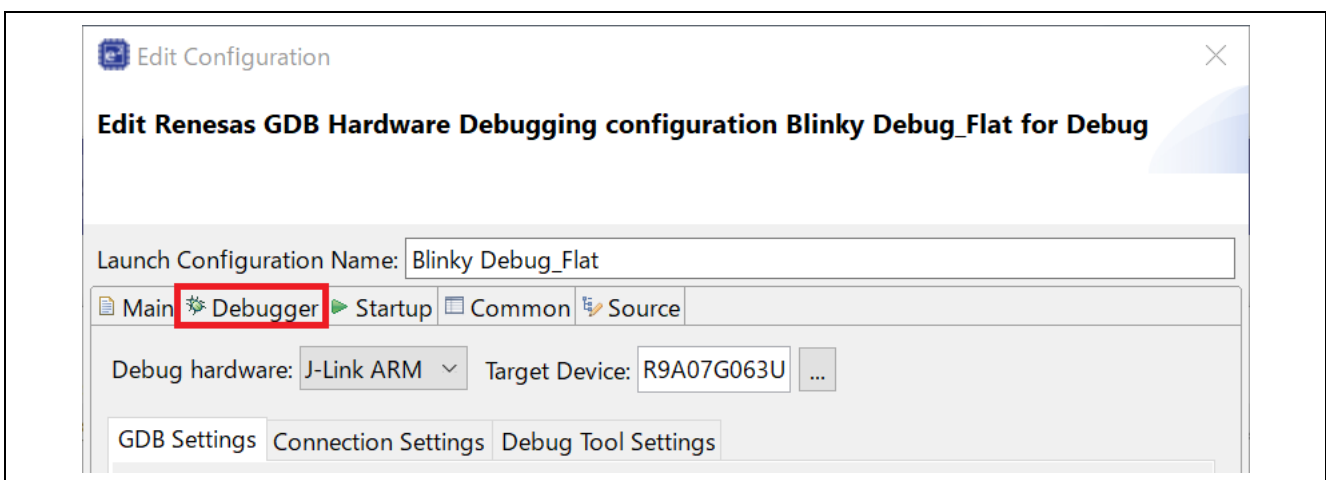

Figure 41 : e2 studio Debugger Configurations window with Blinky project (2)

4. Select the **Connection Settings** tab inside the **Debugger** tab.

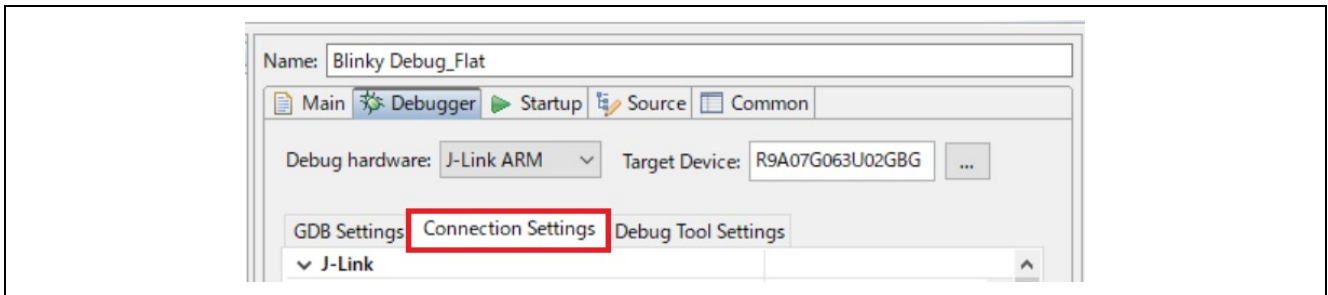

Figure 42 : e2 studio Debugger Configurations window with Blinky project (3)

5. Change **Reset after download** to **Yes**.

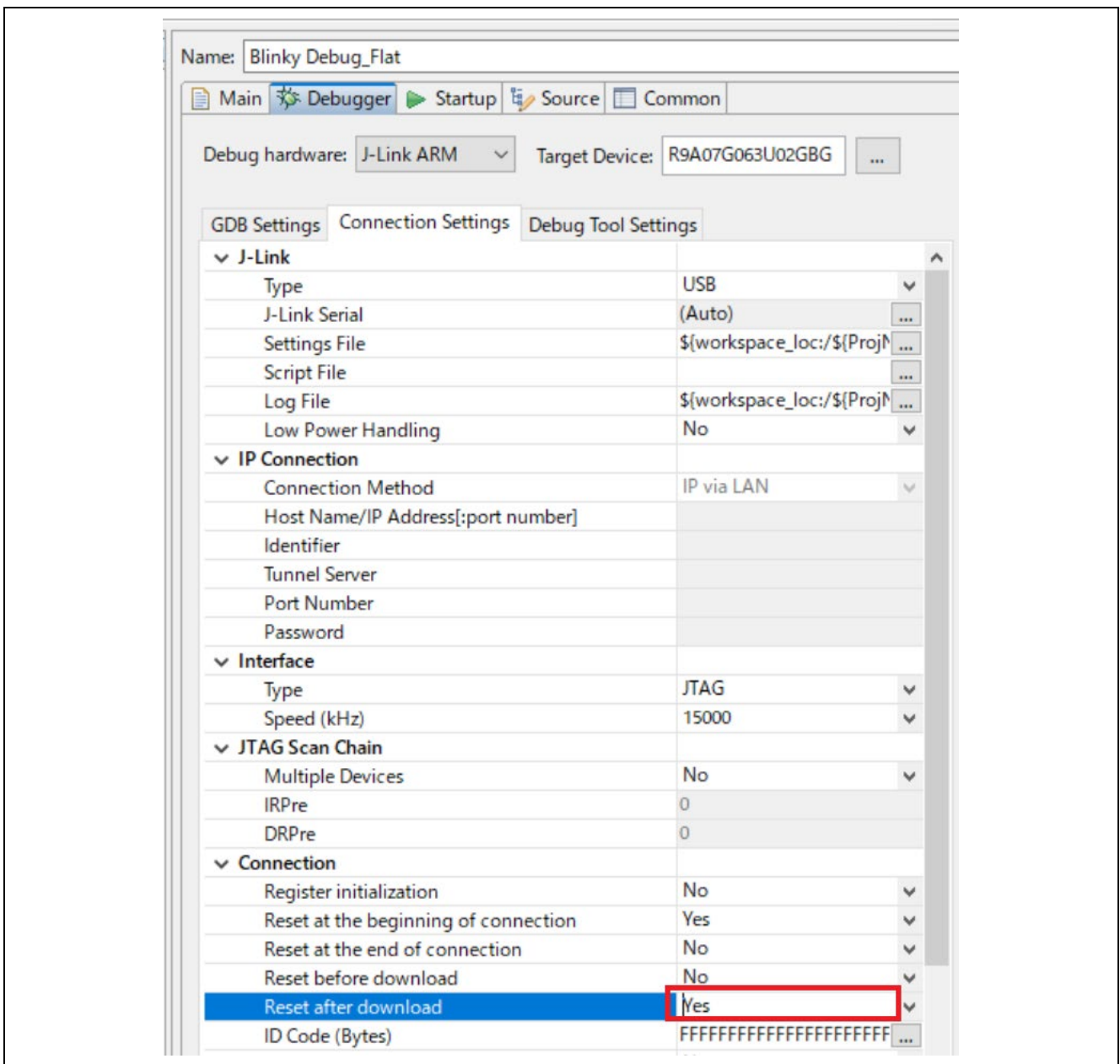

Figure 43 : e2 studio Debugger Configurations window with Blinky project (4)

6. If you have selected the QSPI Edition of the SMARC EVK board, skip to Step 8. If you have selected the OCTAL Edition of the SMARC EVK board, Select the **Debug Tool Settings** tab inside the **Debugger** tab.

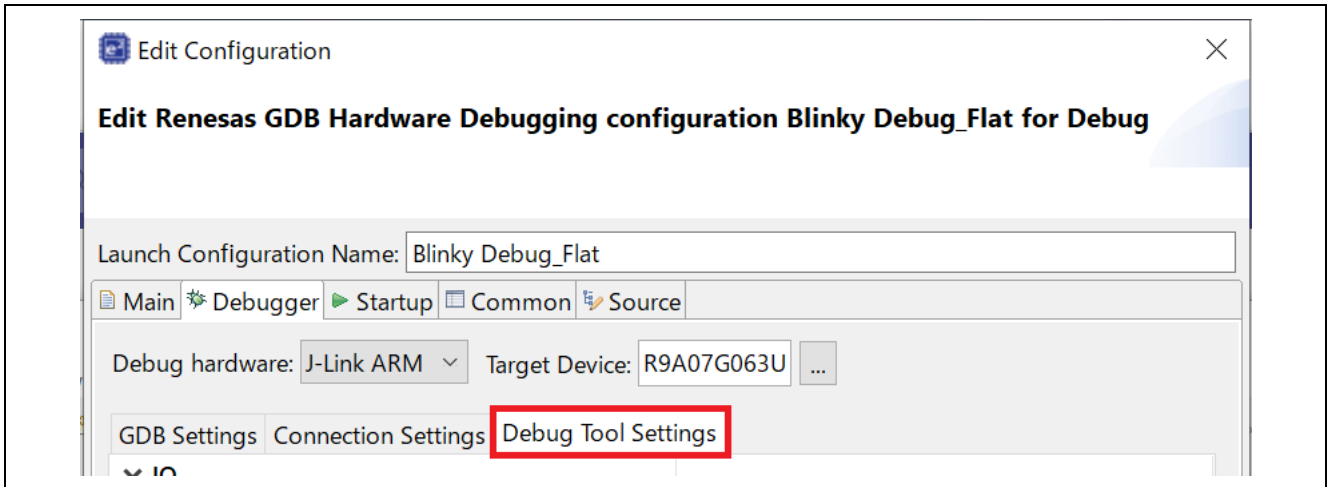

Figure 44 : e2 studio Debugger Configurations window with Blinky project (5)

7. Change **Flash Bus Type** to **OctaBus** (At this time, **Flash Memory Type** is automatically changed to **OctaFlash**).

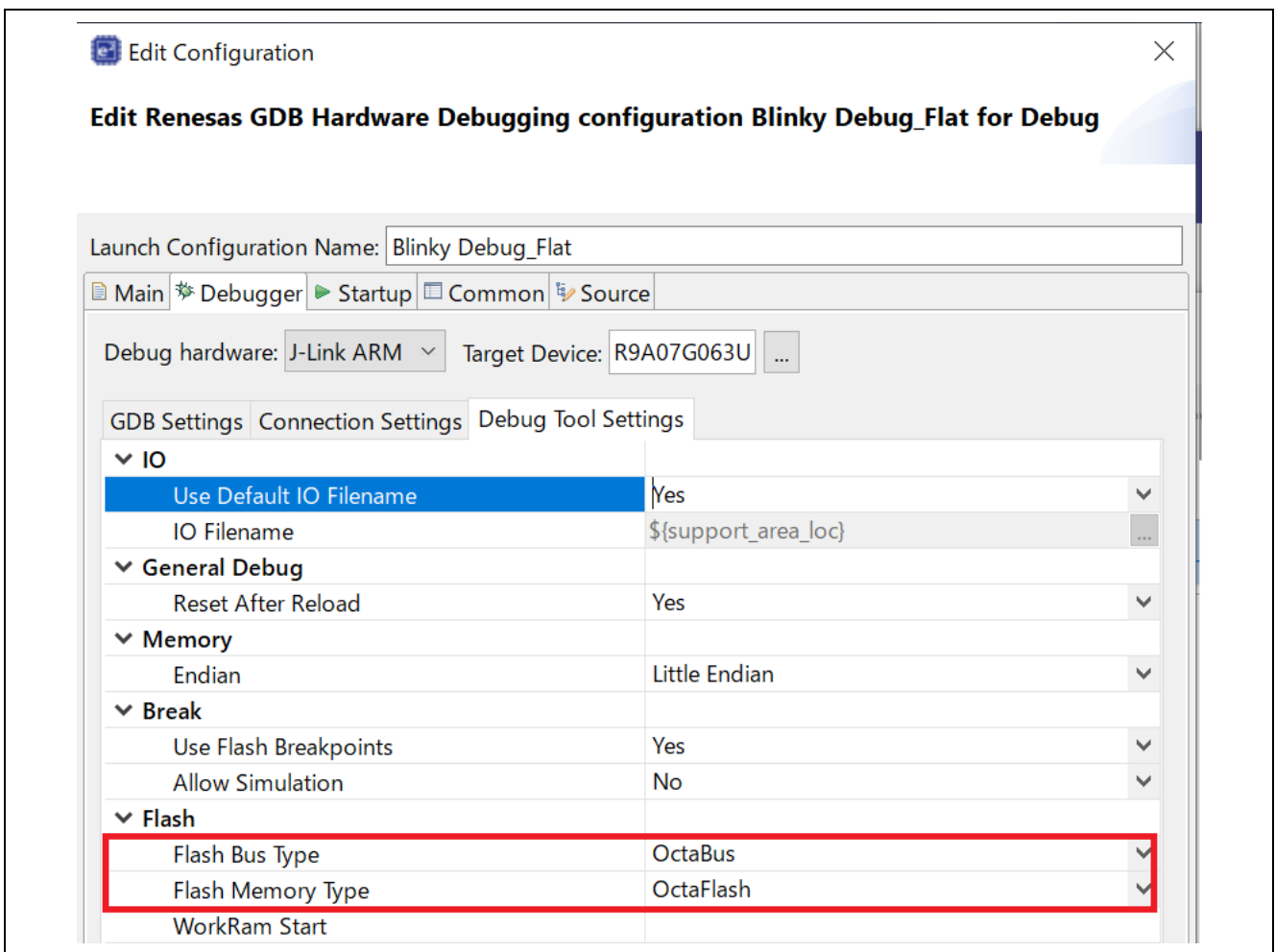

Figure 45 : e2 studio Debugger Configurations window with Blinky project (6)

8. Select the debug configuration for the generated project and select the **Startup** tab.

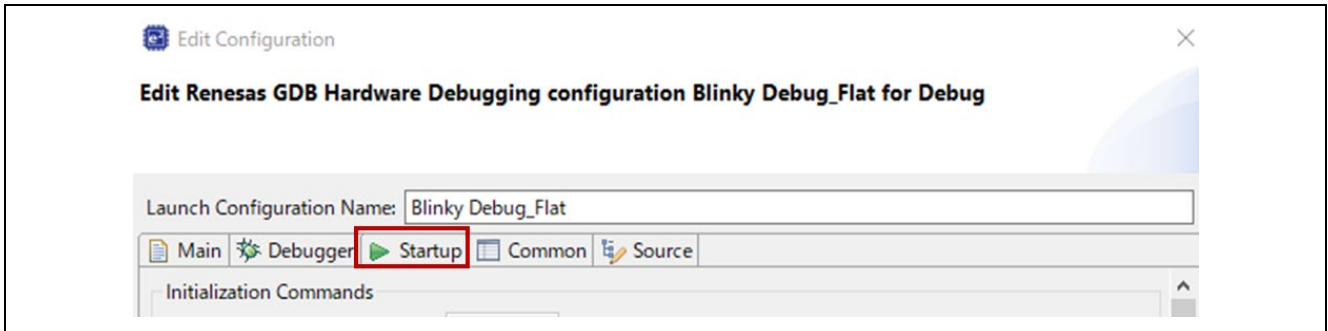

Figure 46 : e2 studio Debugger Configurations window with Blinky project (7)

9. Be sure to change the setting in **Load type** field of **Program Binary [Blinky...]** raw from **Image and Symbols** to **Symbols only**.

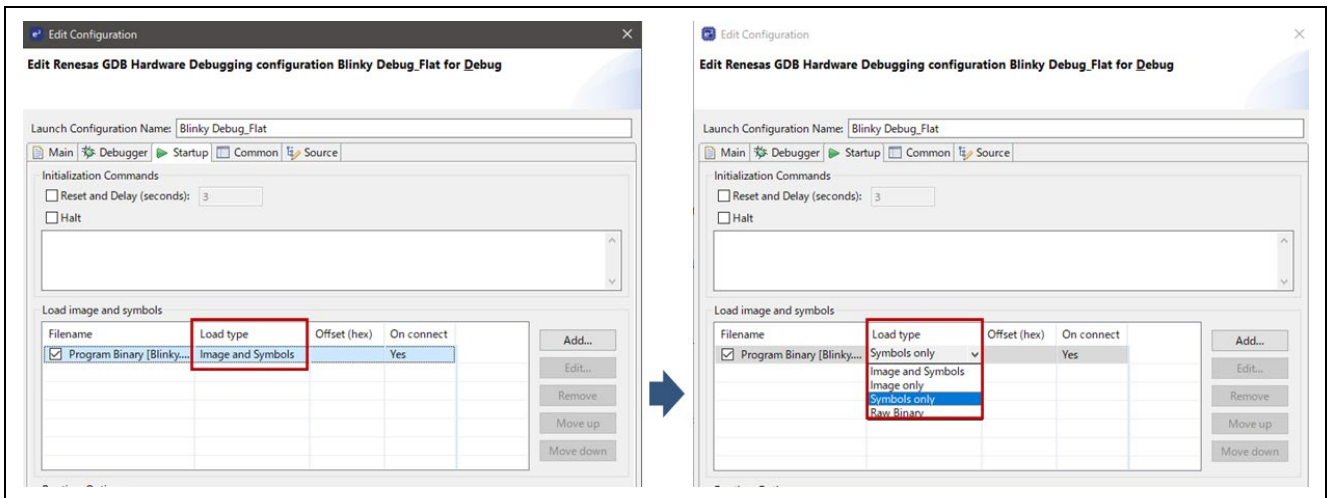

Figure 47 : e2 studio Debugger Configurations window with Blinky project (8)

10. Click on **Add...** to launch **Add download module** window. Then click **Workspace...**, choose **rza3ul_smarc_qspi_ipl.srec(*)** as module to be downloaded and finally click on **OK**.
 * If you have selected "RZ/A3UL Evaluation Board Kit OCTAL Edition (eExecute-In-Place)" in board selection, use "rza3ul_smarc_octal_ipl.srec" instead.

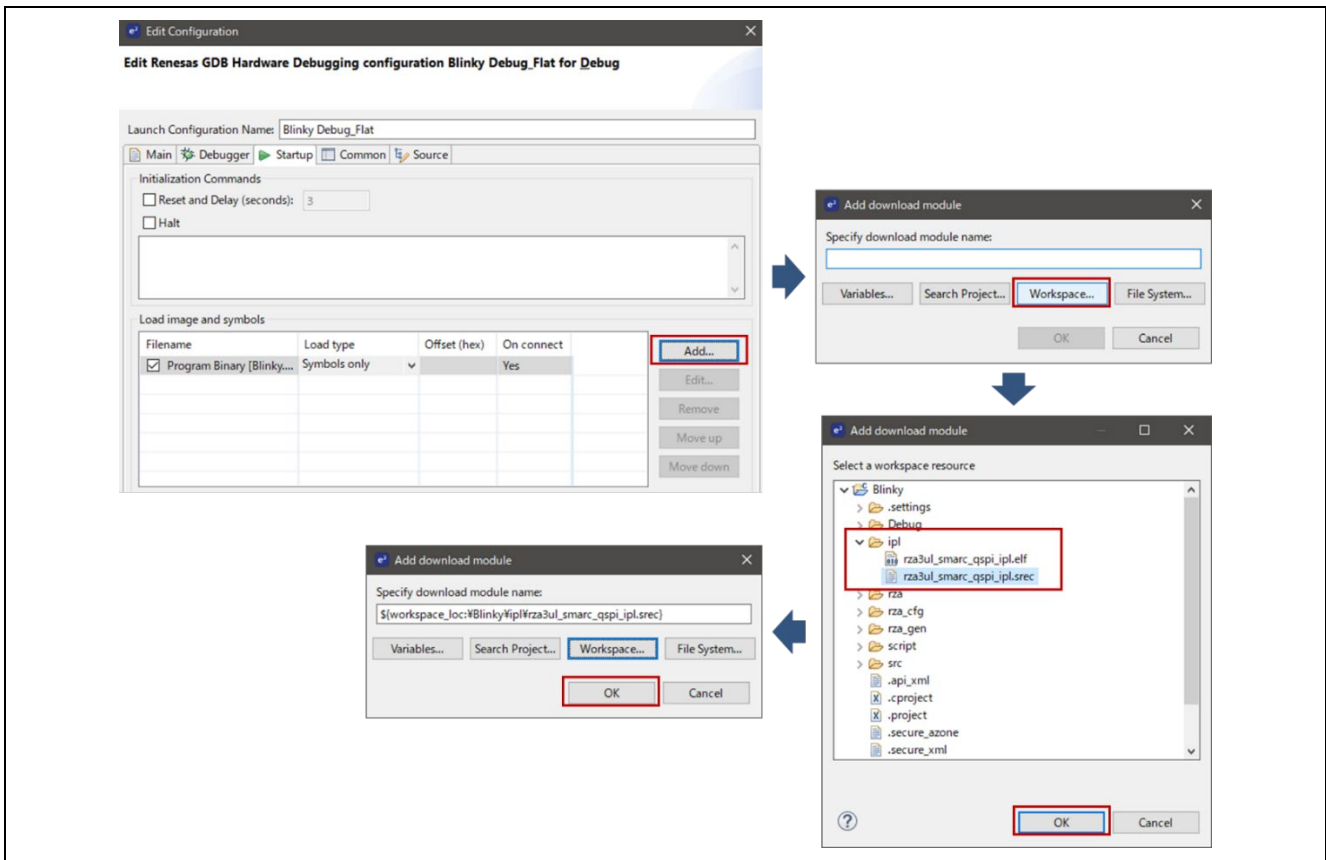

Figure 48 : e2 studio Debugger Configurations window with Blinky project (9)

11. Again, click on **Add...** to launch **Add download module** window. Then click **Workspace...**, choose **BLINKY.srec** as module to be downloaded and finally click on **OK**.

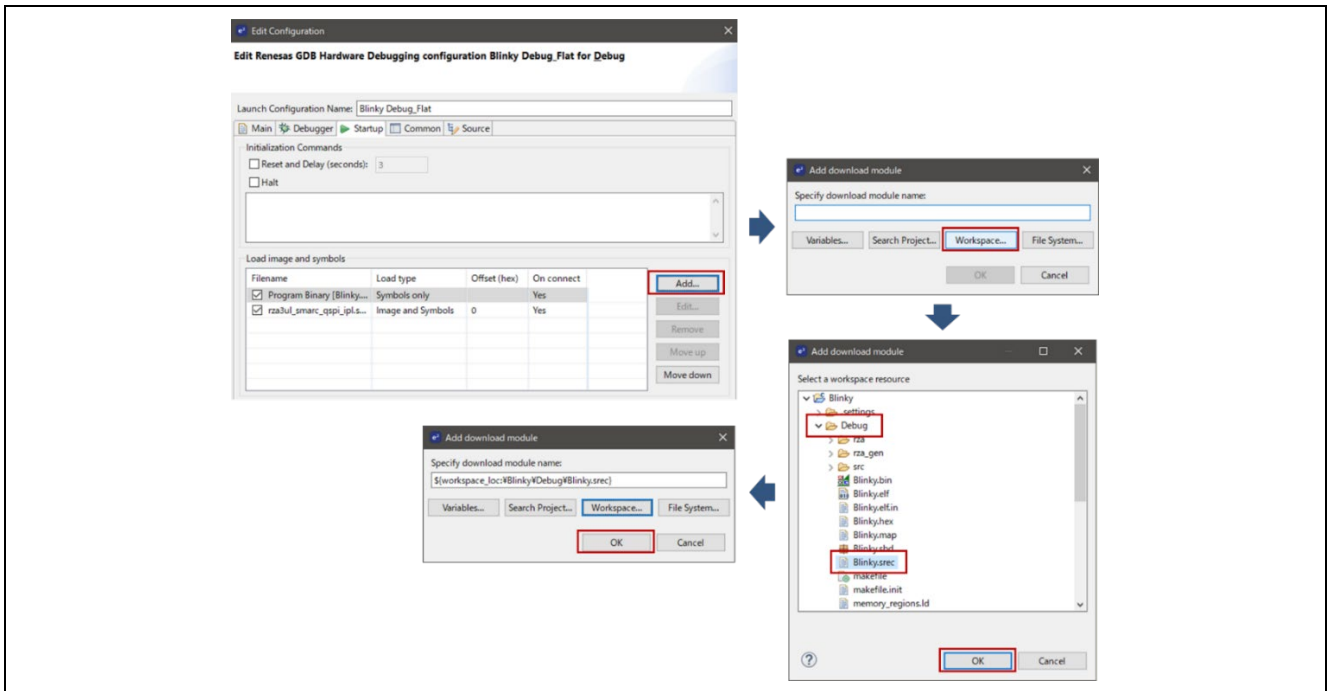

Figure 49: e2 studio Debugger Configurations window with Blinky project (10)

12. Add the "set breakpoint enable-memread 0" to Initialization Commands.

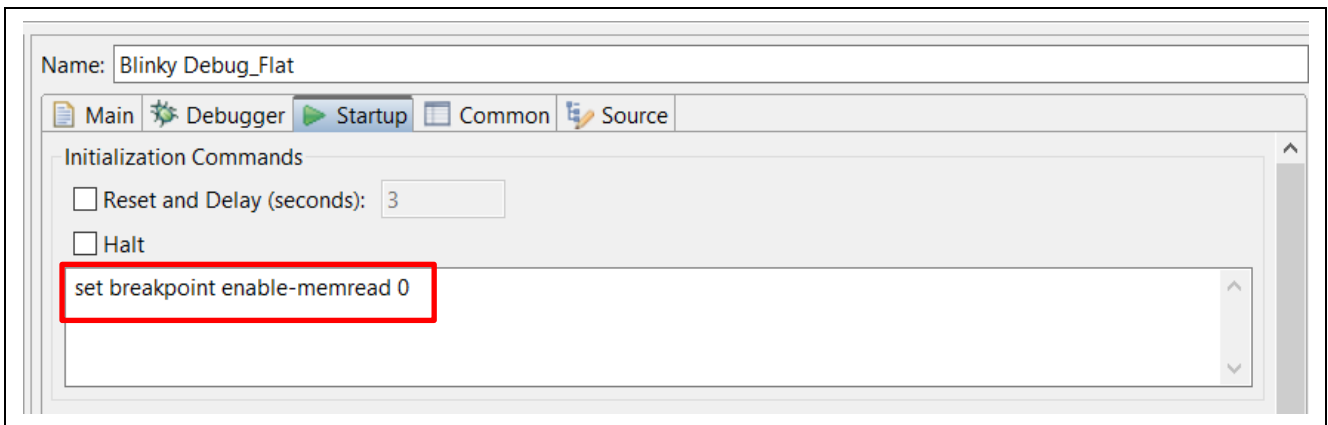

Figure 50: e2 studio Debugger Configurations window with Blinky project (11)

12. Then, click **Debug** button.

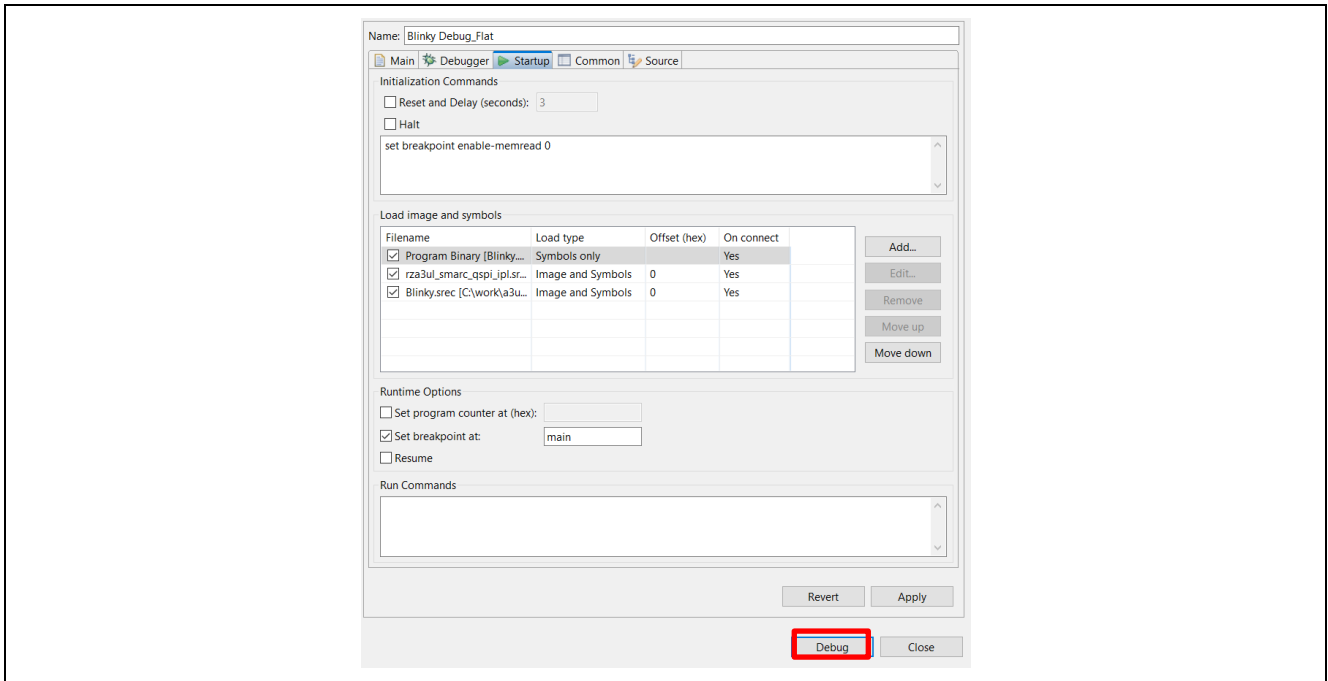

Figure 51: e2 studio Debugger Configurations window with Blinky project (12)

13. Debug session is now started.

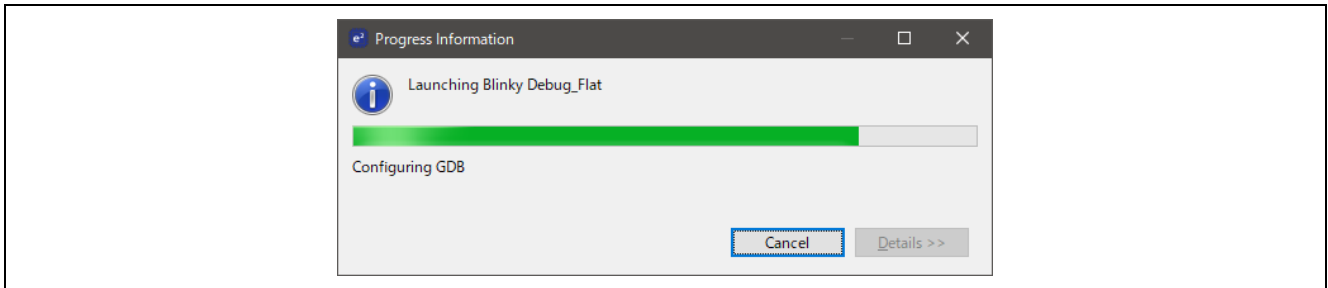

Figure 52: e2 studio Debugger Configurations window with Blinky project (13)

14. If you see the following window, please click **Switch** to continue.

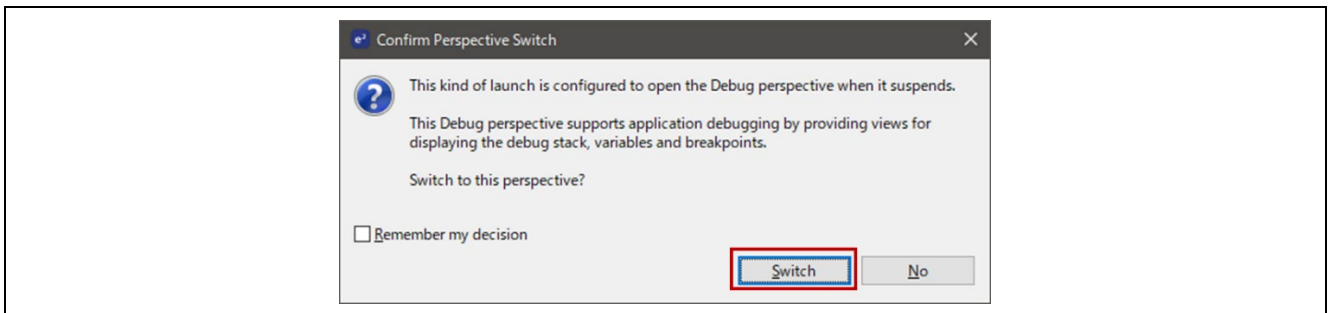

Figure 53: e2 studio Debugger Configurations window with Blinky project (14)

4.6 Details about the Debug Process

In debug mode, e2 studio executes the following tasks:

1. Downloading the application image to QSPI/OctaFlash ROM or DDR SDRAM.
2. Setting a breakpoint at main().
3. Setting the stack pointer register to the stack.

This section describes the detail on the debug process of Blinky Project.

4.6.1 Run the Blinky Project

Click [Run] > [Resume] or click on the Play icon shown below:



Figure 54 : e2 studio Debugger Play icon

Make sure the box **Set breakpoint at:** is checked and specify **main** as its value, Program Counter should be stopped at main() function.

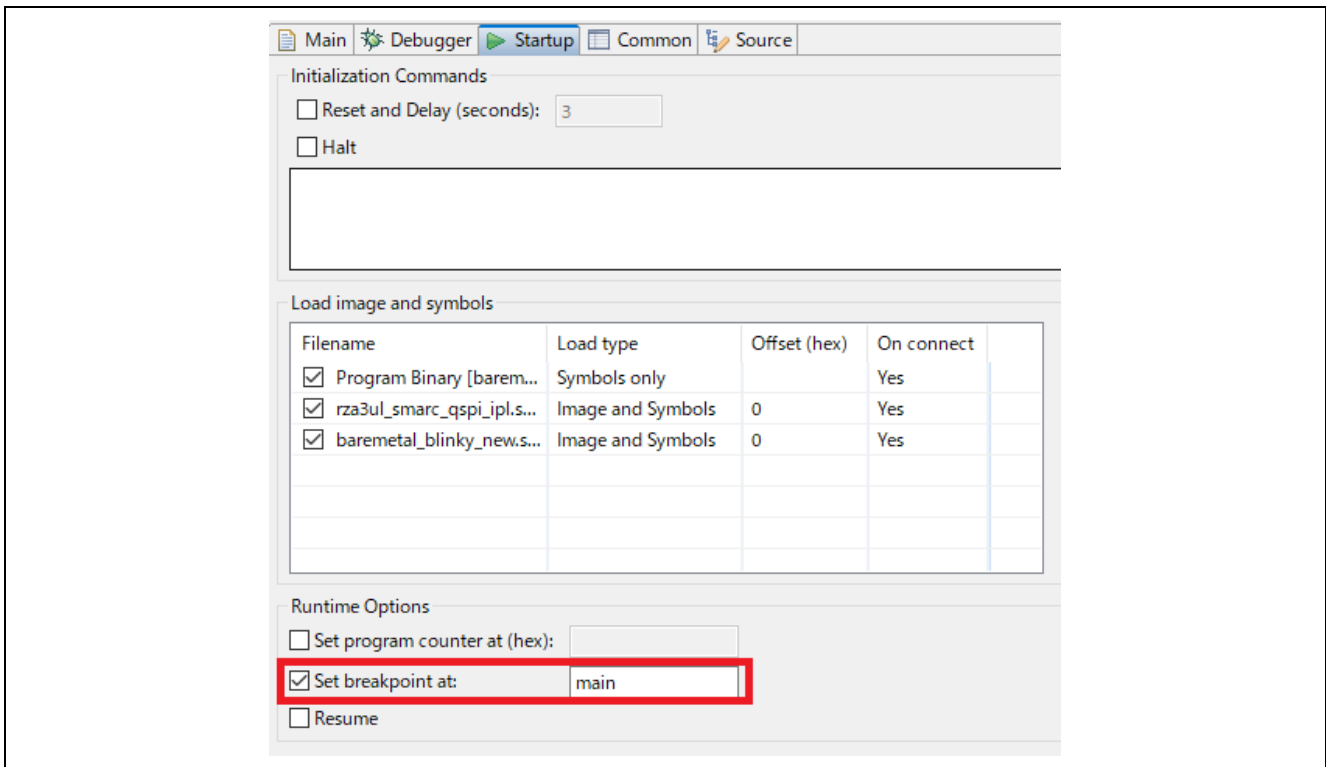

Figure 55 : Set breakpoint at: option

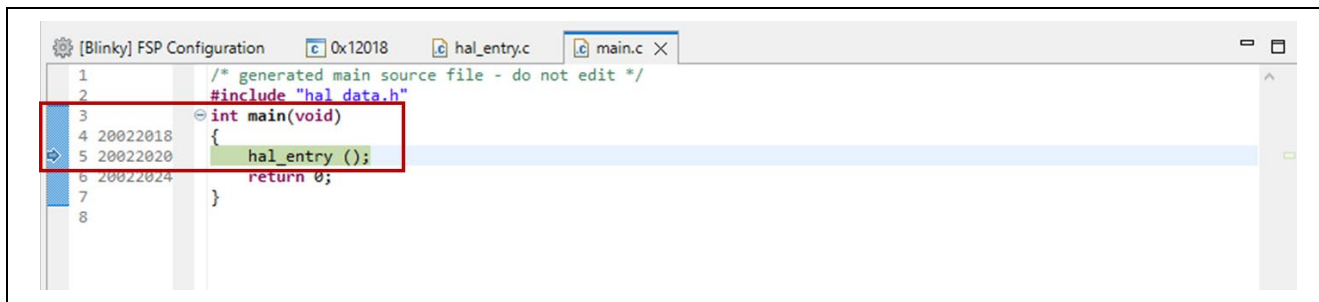

Figure 56 : Blinky project in Debug Mode

After that LED on the Pmod LED should start to blink when clicking [Run] > [Resume] or Play icon again.

5. FSP Application Launch with e2 studio

5.1 Create a Project

5.1.1 What is a Project?

In e2 studio, all FSP applications are organized in RZ MPU projects. Setting up an RZ MPU project involves:

1. Create a Project
2. Configuring a Project

These steps are described in detail in the next two sections. When you have existing projects already, after you launch e2 studio and select a workspace, all projects previously saved in the selected workspace are loaded and displayed in the **Project Explorer** window. Each project has an associated configuration file named `configuration.xml`, which is in the project's root directory.

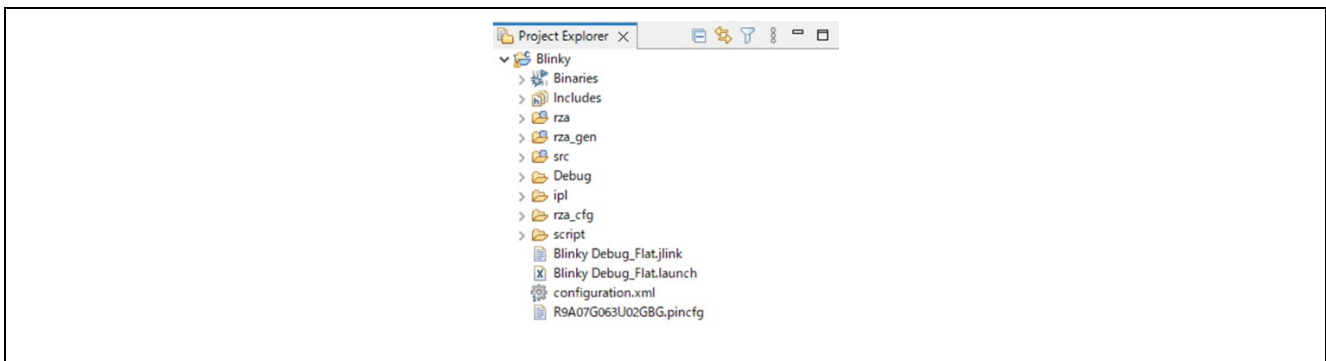

Figure 57 : e2 studio FSP Configuration Perspective

Double-click on the `configuration.xml` to open the RZ MPU Project Editor. To edit the project configuration, make sure that the **FSP Configuration** perspective shown below is selected in the upper right-hand corner of the e2 studio window. Once selected, you can use the editor to view or modify the configuration settings associated with this project.

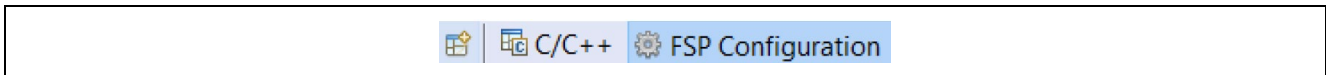

Figure 58 : e2 studio FSP Configuration Perspective

Note:

Whenever the RZ project configuration (that is, the configuration.xml file) is saved, a verbose RZ Project Report file (rza_cfg.txt) with all the project settings is generated. The format allows differences to be easily viewed using a text comparison tool. The generated file is located in the project root directory.

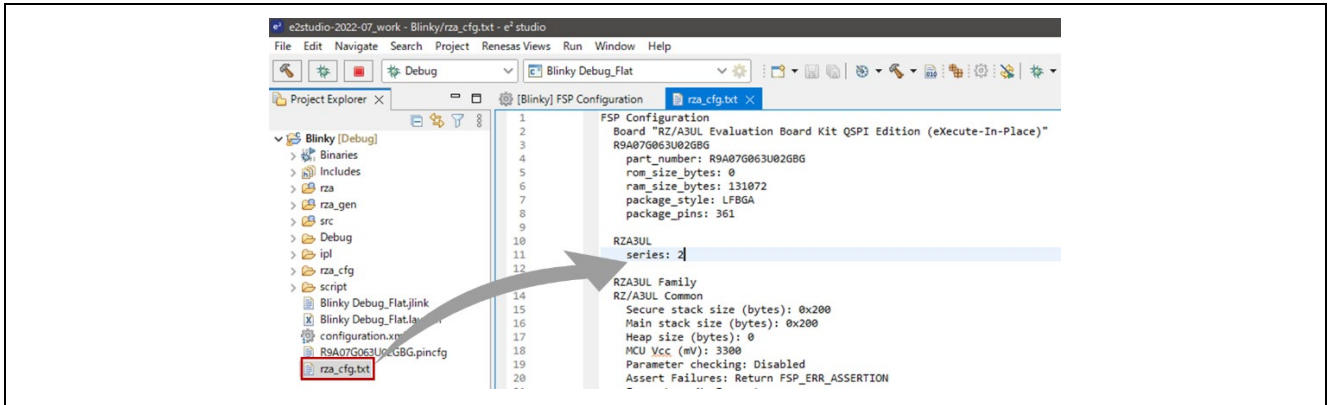

Figure 59 : RZ Project Report

The RZ Project Editor has several tabs. The configuration steps and options for individual tabs are discussed in the following sections.

Note:

The tabs available in the RZ Project Editor depend on the e2 studio version and the layout may vary slightly, however the functionality should be easy to follow.

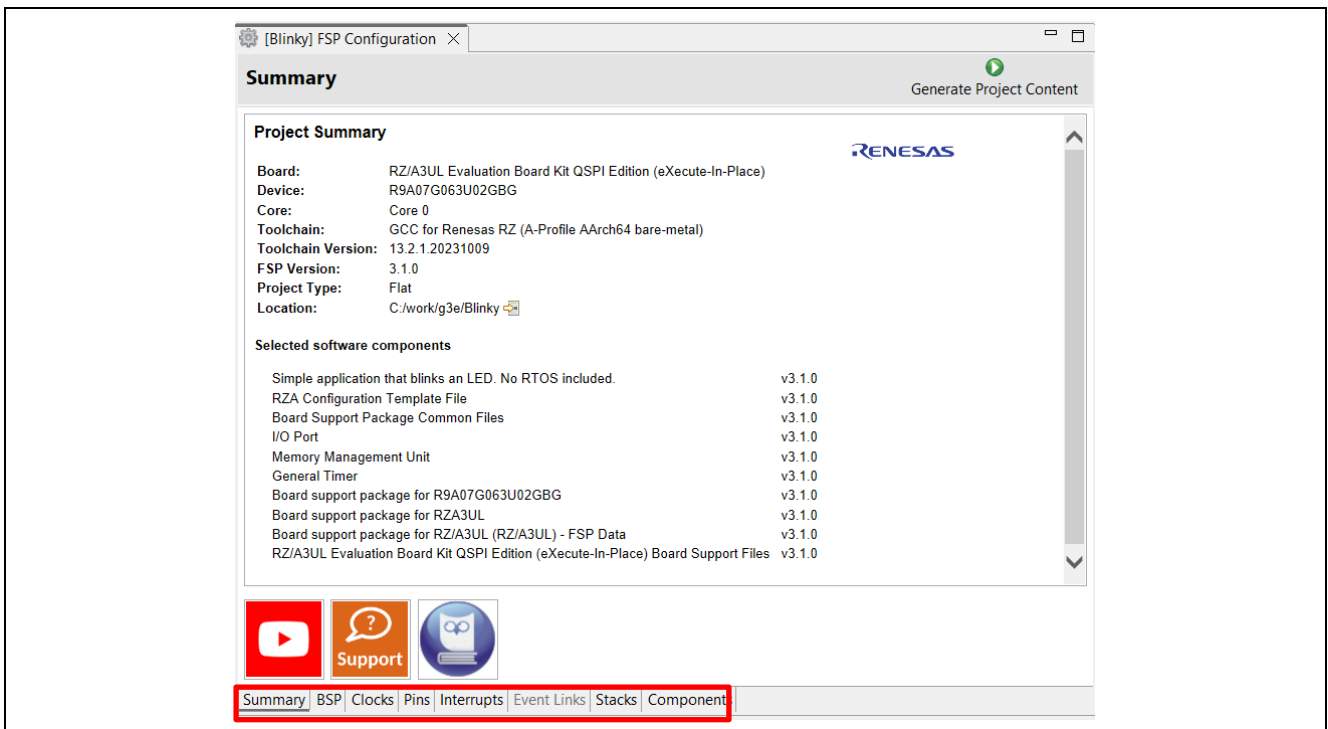

Figure 60 : RZ Project Editor tabs

5.1.2 Creating a New Project

For RZ MPU applications, generate a new project using the following steps:

1. Click on [File] > [New] > [C/C++ Project].

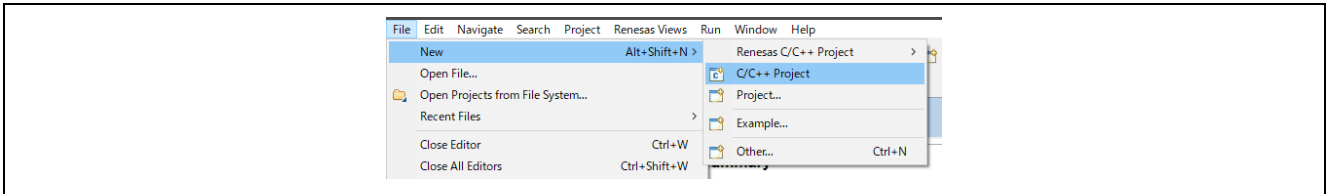

Figure 61 : New RZ MPU Project

2. Click on the **Renesas RZ/A C/C++ FSP Project** template for the type of project you are creating.

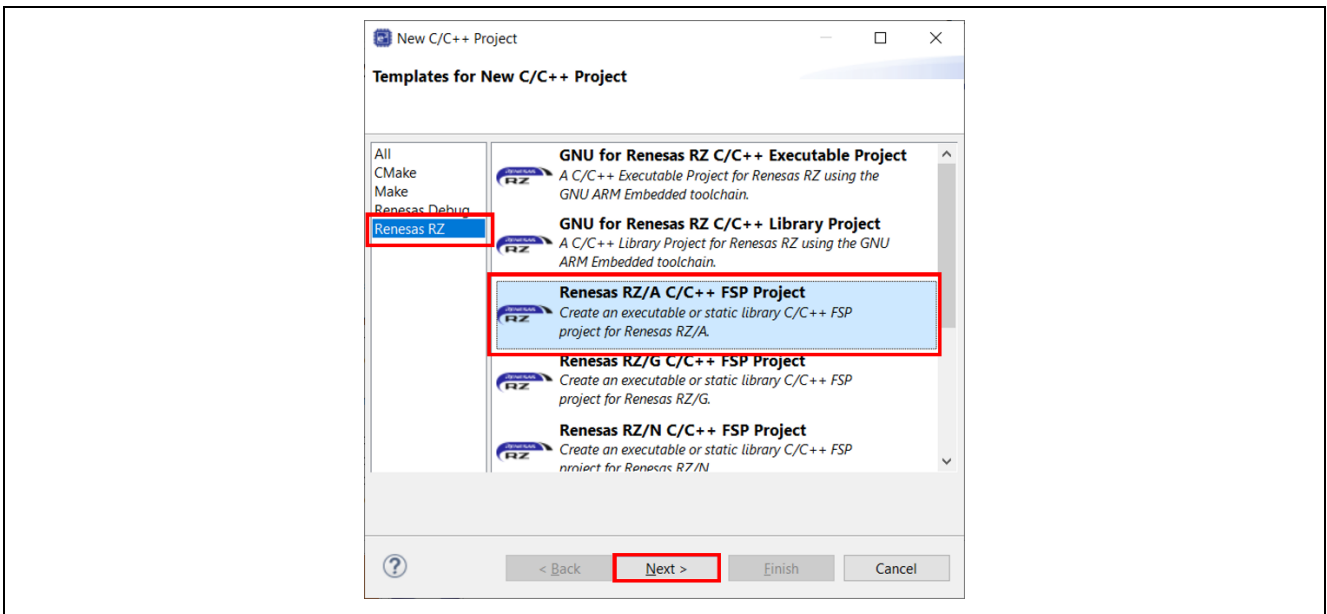

Figure 62 : New Project Templates

3. Select a project name and location.

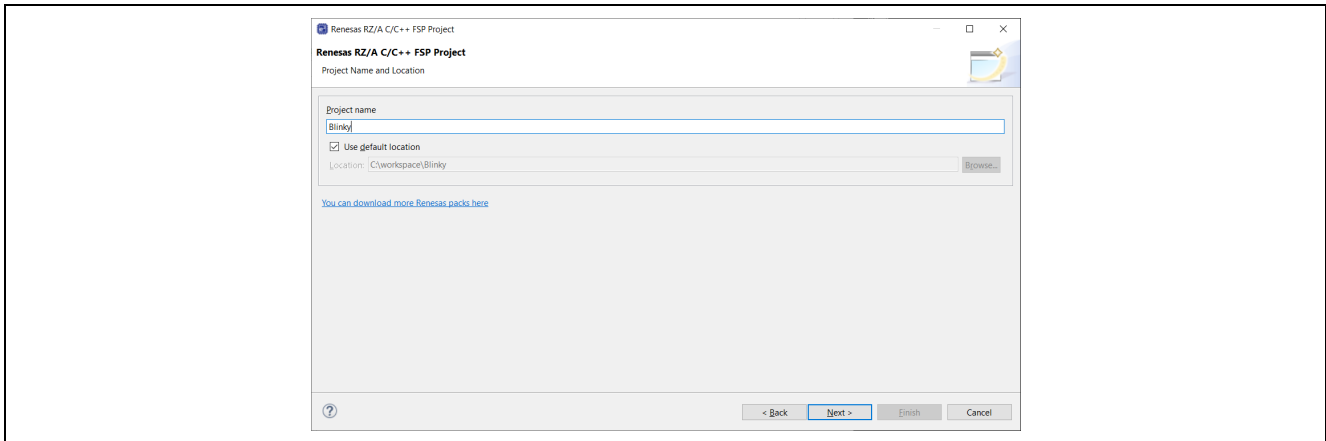

Figure 63 : RZ MPU Project Generator (Screen 1)

4. Click [Next].

5.1.2.1 Selecting a Board and Toolchain

In the Project Configuration window select the hardware and software environment:

1. Select the **FSP version**.
2. Select the **Board** for your application. You can select an existing RZ MPU Evaluation Kit or **Custom User Board** for any of the RZ MPU devices with your own BSP definition. (Please refer 2.1.2.1 for more information about the RZ MPU Evaluation Kit.)
3. Select the **Device**. The **Device** is automatically populated based on the **Board** selection. Only change the **Device** when using the **Custom User Board QSPI Boot (eXecute-In-Place)** board selection.
4. To add threads, select **RTOS**, or **No RTOS** if an RTOS is not being used.
5. The **Toolchain** selection defaults to **GNU ARM A-Profile (AArch64 bare-metal)**.
6. Select the **Toolchain version**. This should default to the installed toolchain version.
7. Select the **Debugger**. The J-Link Arm Debugger is preselected.
8. Click **Next**.

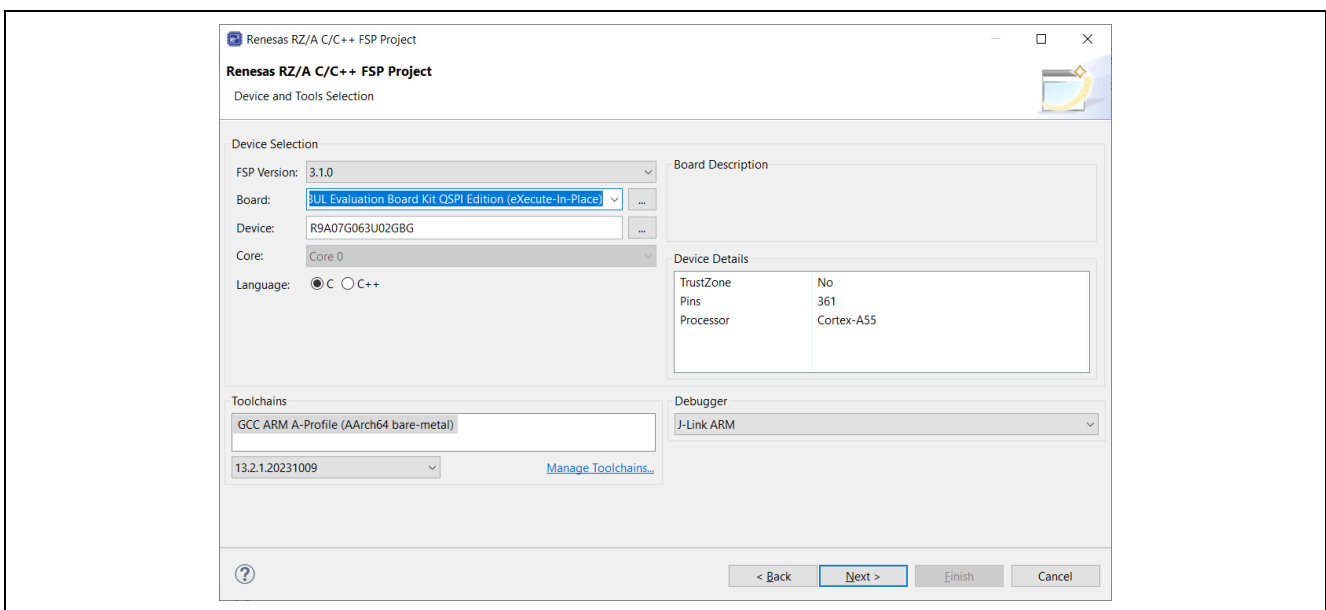

Figure 64 : RZ MPU Project Generator (Screen 2)

5.1.2.2 Selecting a Project Template

In the next window, select the build artifact and RTOS.

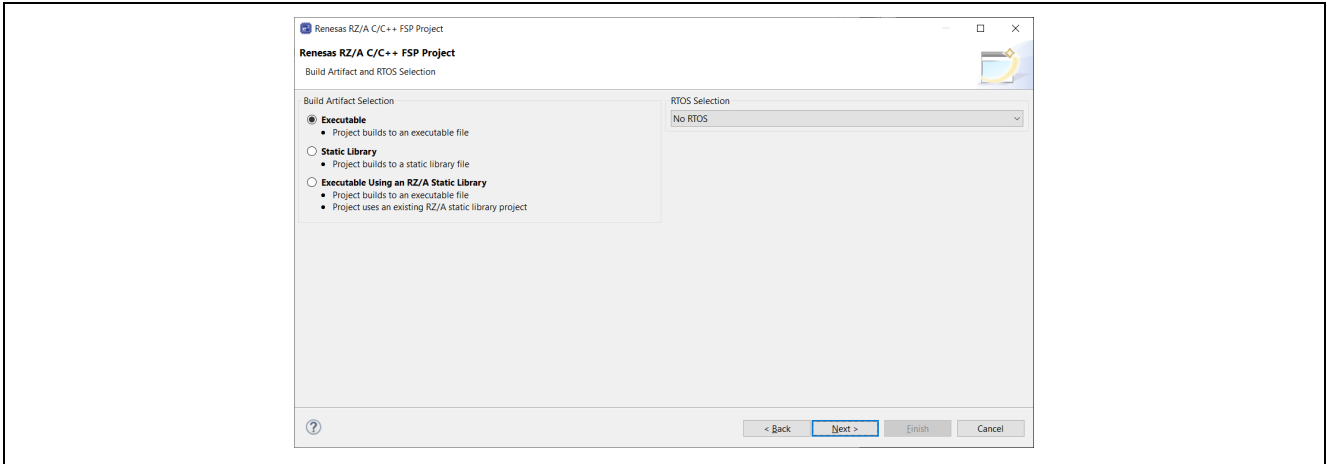

Figure 65 : RZ MPU Project Generator (Screen 3)

In the next window, select a project template from the list of available templates. By default, this screen shows the templates that are included in your current RZ/A MPU Pack. Once you have selected the appropriate template, click **Finish**.

Note:

The tabs available in the RZ Project Editor depend on the e2 studio version and the layout may vary slightly, however the functionality should be easy to follow.

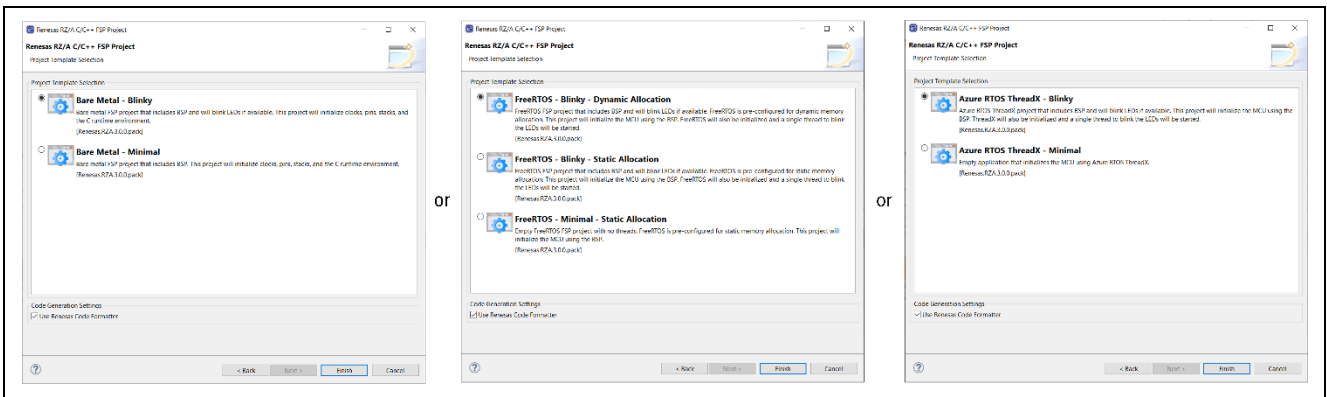

Figure 66 : RZ MPU Project Generator (Screen 4)

When the project is created, e2 studio displays a summary of the current project configuration in the RZ MPU Project Editor.

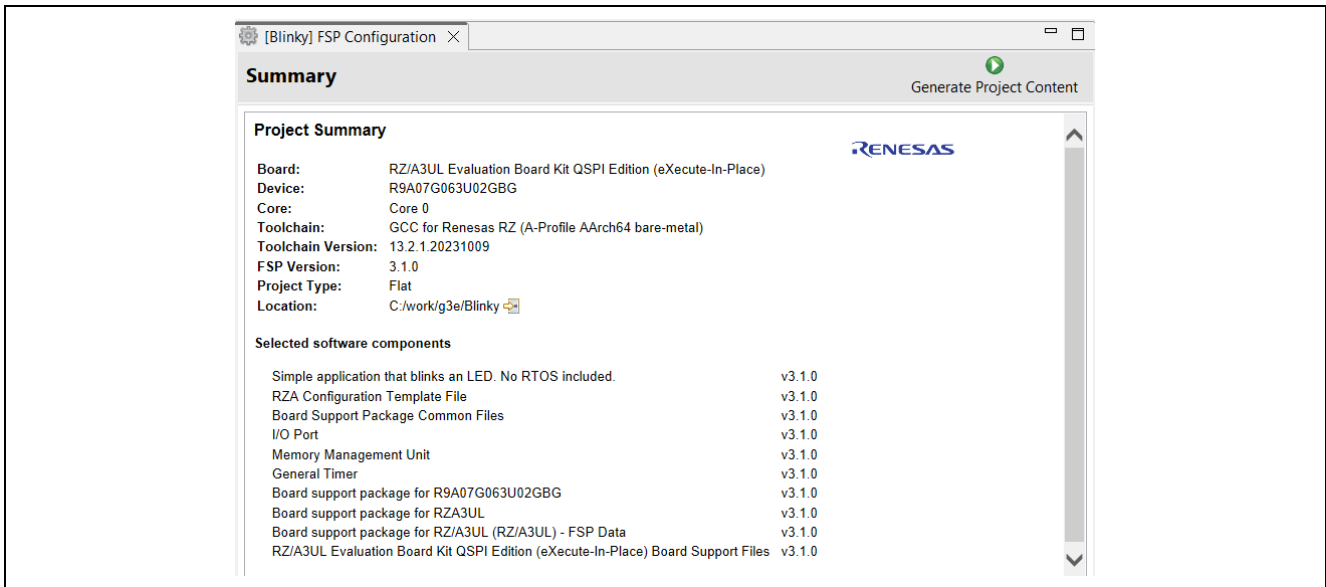

Figure 67 : RZ MPU Project Editor and available editor tabs

- With the **Summary** tab, you can see all the key characteristics of the project: board, device, toolchain, and more.
- With the **BSP** tab, you can change board specific parameters from the initial project selection.
- With the **Clocks** tab, you can configure the MCU clock settings for your project.
- With the **Interrupts** tab, you can add new user events/interrupts.
- With the **Stacks** tab, you can add and configure FSP modules. For each module selected in this tab, the **Properties** window provides access to the configuration parameters, interrupt selections.
- The **Components** tab provides an overview of the selected modules. Although you can also add drivers for specific FSP releases and application sample code here, this tab is normally only used for reference.

The functions and use of each of supported tabs is explained in detail in the next section.

Please note that RZ/A FSP doesn't support **Event Links** tab and so, those tabs are grayed out as shown above.

5.2 Configuring a Project

Each of the configurable elements in an FSP project can be edited using the appropriate tab in the RZ Configuration editor window. Importantly, the initial configuration of the MPU after reset and before any user code is executed is set by the configuration settings in the **BSP** tab. When you select a project template during project creation, e2 studio configures default values that are appropriate for the associated board. You can change those default values as needed. The following sections detail the process of configuring each of the project elements for each of the associated tabs.

5.2.1 Summary Tab

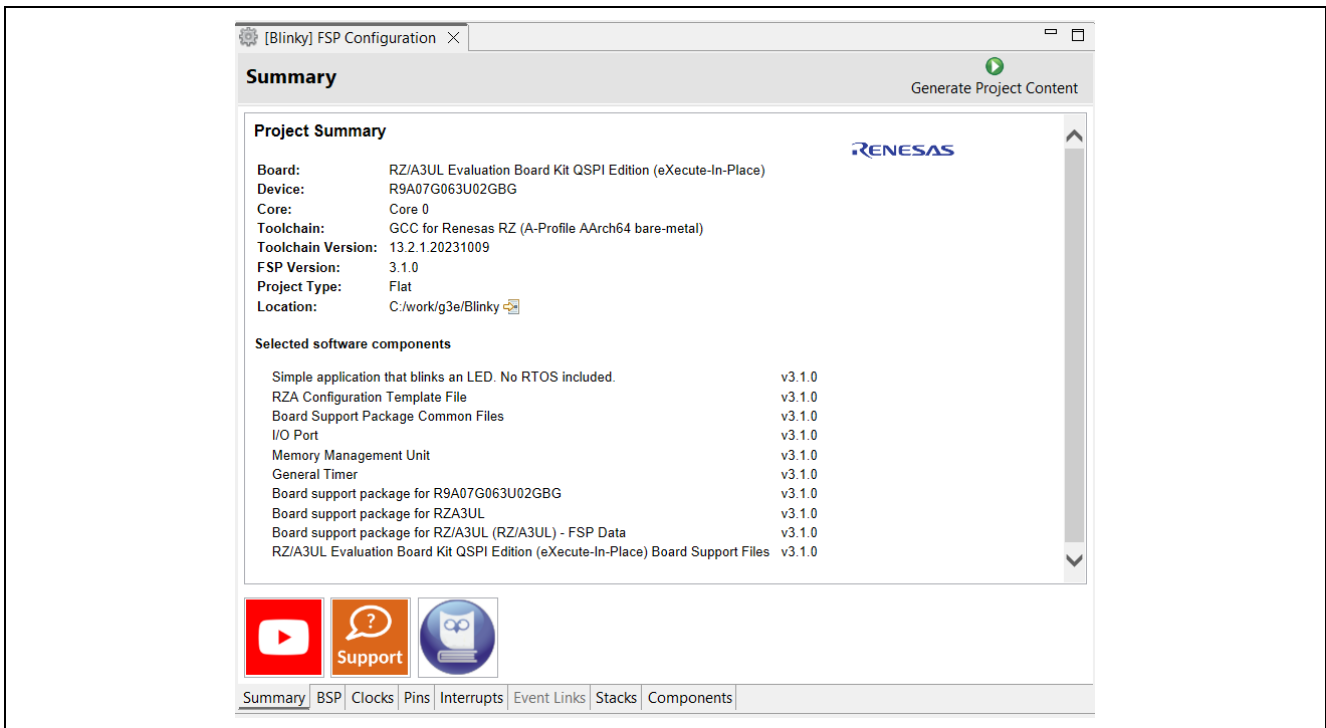

Figure 68 : Configuration Summary tab

The **Summary** tab, seen in the above figure, identifies all the key elements and components of a project. It shows the target board, the device, toolchain and FSP version. Additionally, it provides a list of all the selected software components and modules used by the project. This is a more convenient summary view when compared to the **Components** tab.

5.2.2 Configuring the BSP

The **BSP** tab shows the currently selected board (if any) and device. The Properties view is located in the lower left of the Project Configurations view as shown below:

Note:

If the Properties view is not visible, click **Window > Show View > Properties** in the top menu bar.

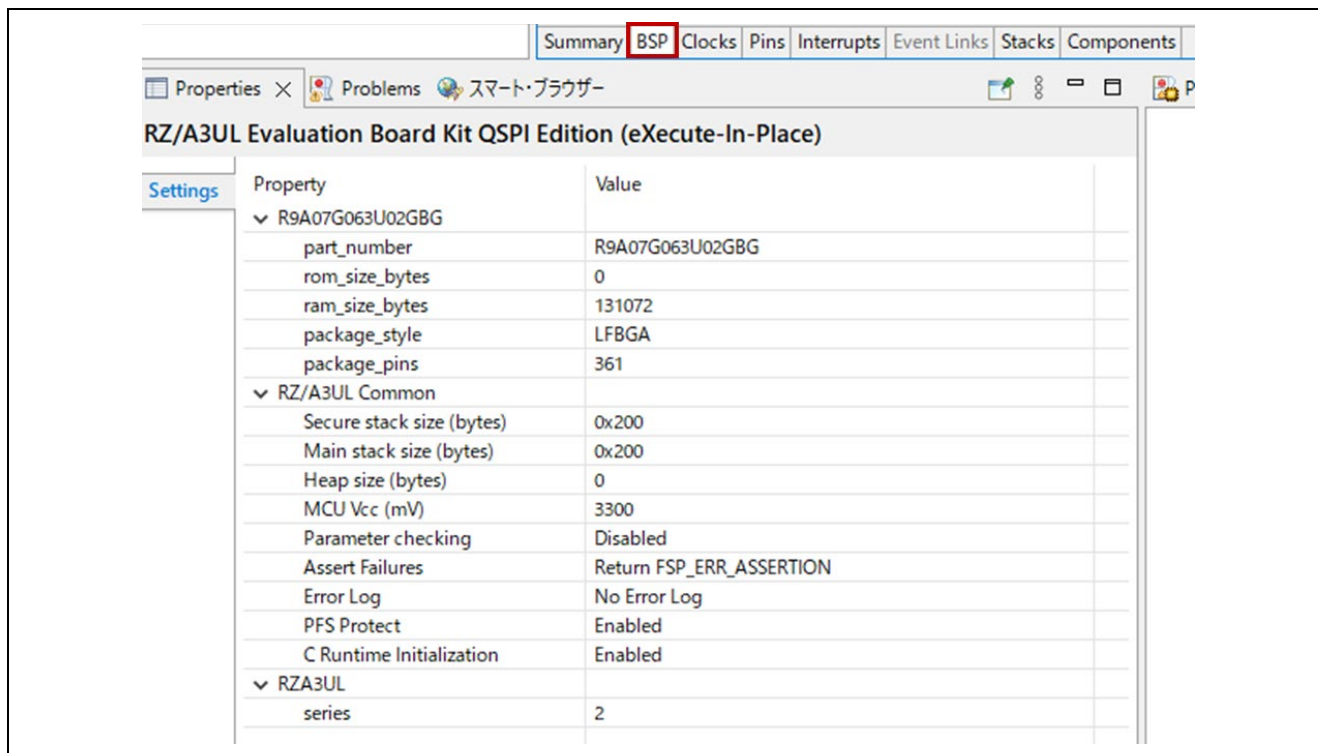

Figure 69 : Configuration BSP tab

The **Properties** view shows the configurable options available for the BSP. These can be changed as required. The BSP is the FSP layer above the MPU hardware.

When you click the **Generate Project Content** button, the BSP configuration contents are written to `rza_cfg/fsp_cfg/bsp/bsp_cfg.h`. This file is created if it does not already exist.

Warning:

Do not edit this file as it is overwritten whenever the Generate Project Content button is clicked.

5.2.3 Configuring Clocks

The **Clocks** tab presents a graphical view of the MPU's clock tree, and each HAL driver uses the settings for dedicated numerical calculation. For example, `scif_uart` driver calculates the communication rate from the settings in Clocks tab. Please note that PLLs should be configured by IPL and therefore, PLL settings should be consistent with those in IPL.

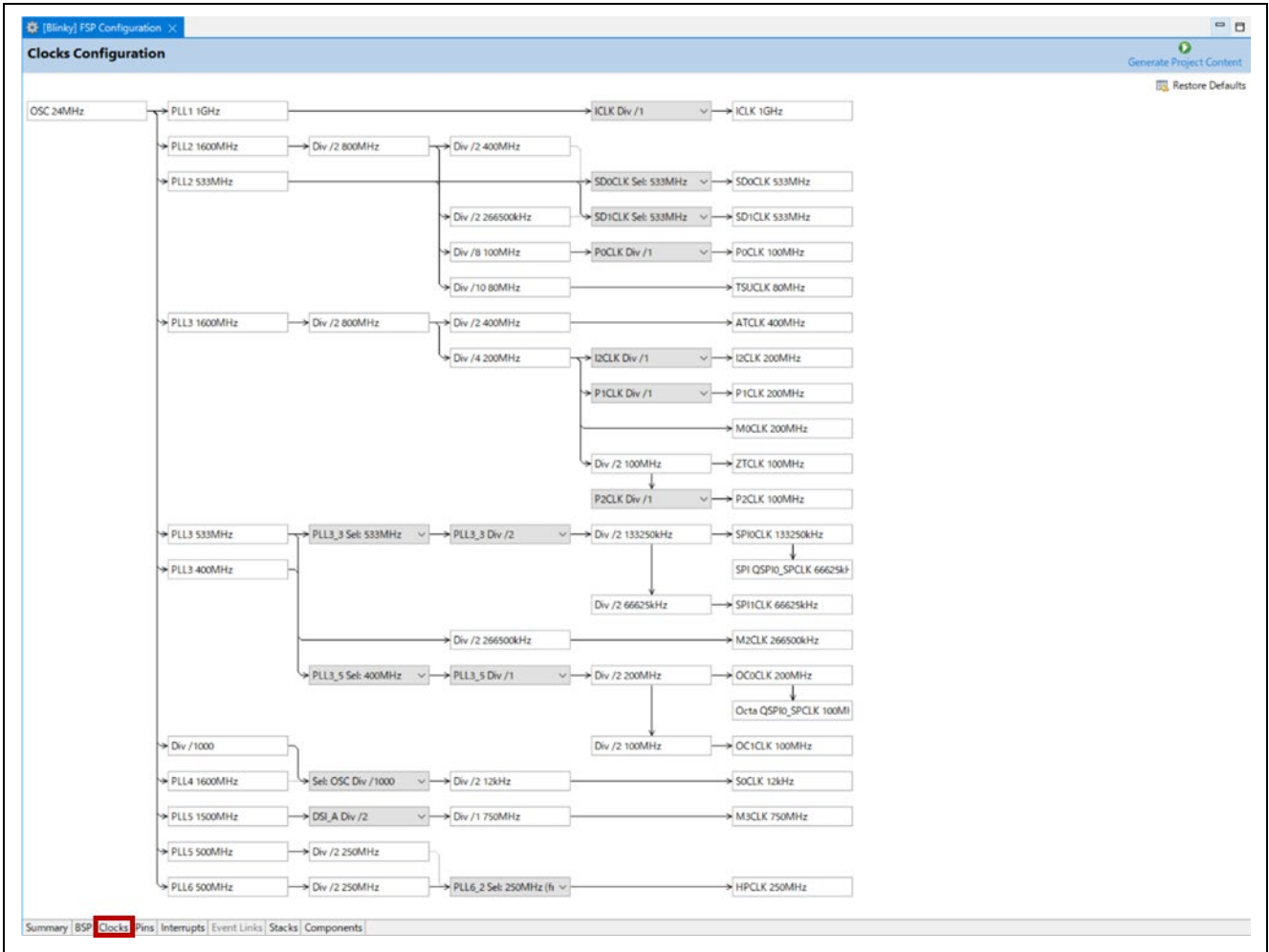

Figure 70 : Configuration Clocks tab

When mousing over the blocks of PLLs on clocks tab, you should see the pop-up message describing this precaution.

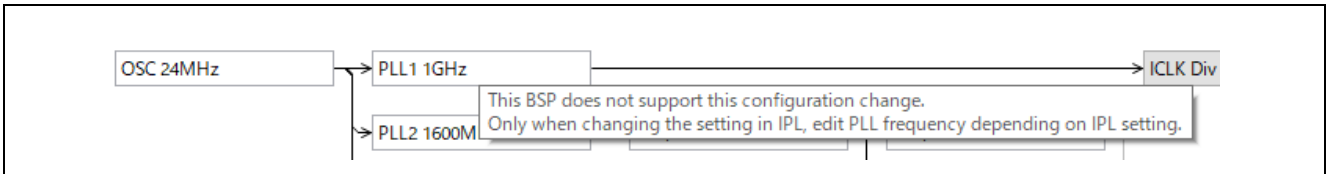

Figure 71 : Precautions for PLL settings

When you click the **Generate Project Content** button, the clock configuration contents are written to: rza_gen/bsp_clock_cfg.h

This file will be created if it does not already exist.

Warning:

Do not edit this file as it is overwritten whenever the **Generate Project Content** button is clicked.

5.2.4 Configuring Pins

The pins tab provides flexible configuration of the MPU’s pins. As many pins can provide multiple functions, they can be configured on a peripheral basis. For example, selecting a serial channel via the SCIF peripheral offers multiple options for the location of the receive and transmit pins for that module and channel. Once pins are configured, it is shown as green in the **FSP Visualization** view.

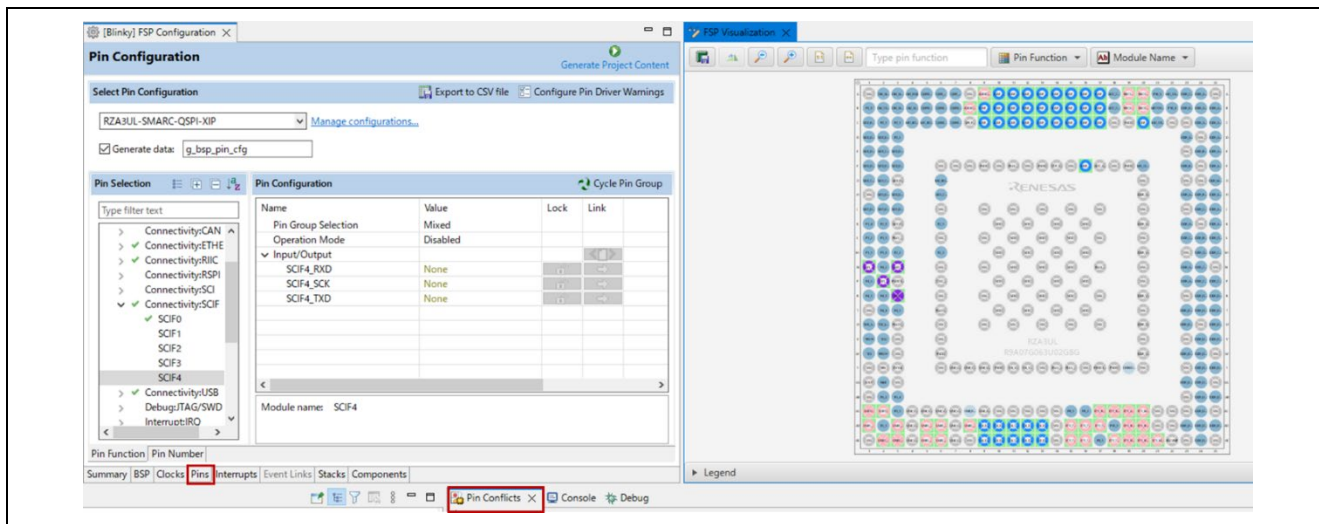

Figure 72 : Pin Configuration

The pin configurator includes built-in conflict checker. So, if the same pin is allocated to another peripheral or I/O function, the pin will be shown as red in the **FSP Visualization** view and with white cross in a red square in the **Pin Selection** pane and **Pin Configuration** pane in the main **Pins** tab.

In the example shown below, port P13_1 is already used by the Display, and the attempt to connect to this pin to the Serial Communication Interface with FIFO (SCIF) results in dangling connection error. To fix this error, select another port from the pin drop-down list or disable the Display.

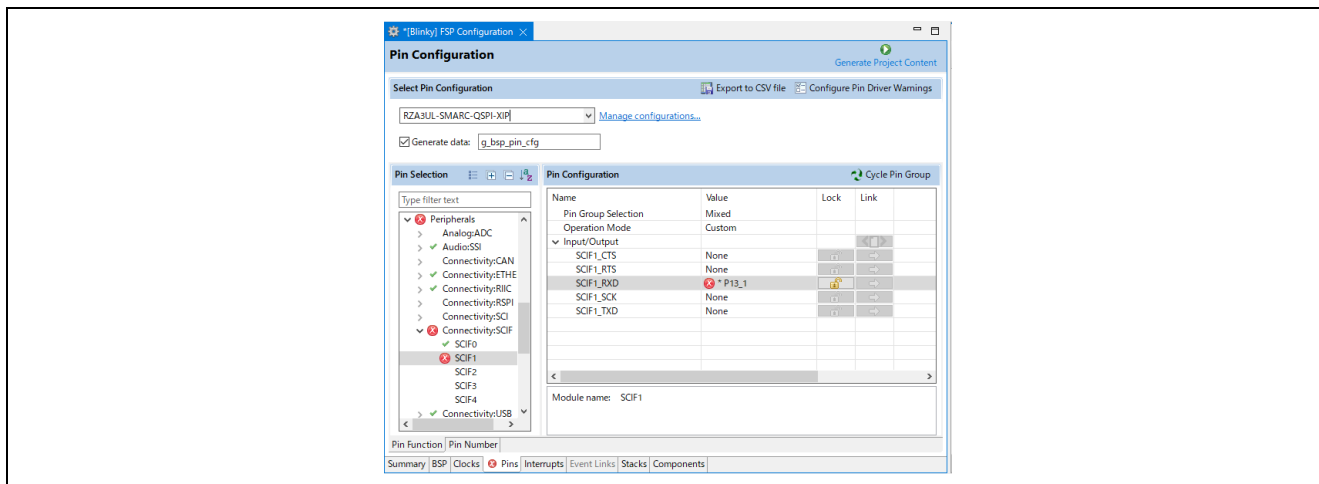

Figure 73 : e2 studio Pin Configurator

When you click the **Generate Project Content** button, the pin configuration Pin contents are written to: ra_gen\bsp_pin_cfg.h. This file will be created if it does not already exist.

Warning:

Do not edit this file as it is overwritten whenever the **Generate Project Content** button is clicked.

5.2.5 Configuring Interrupts from the Stacks Tab

You can use the **Properties** view in the **Stacks** tab to enable interrupts by setting the interrupt priority. Select the driver in the **Stacks** pane to view and edit its properties.

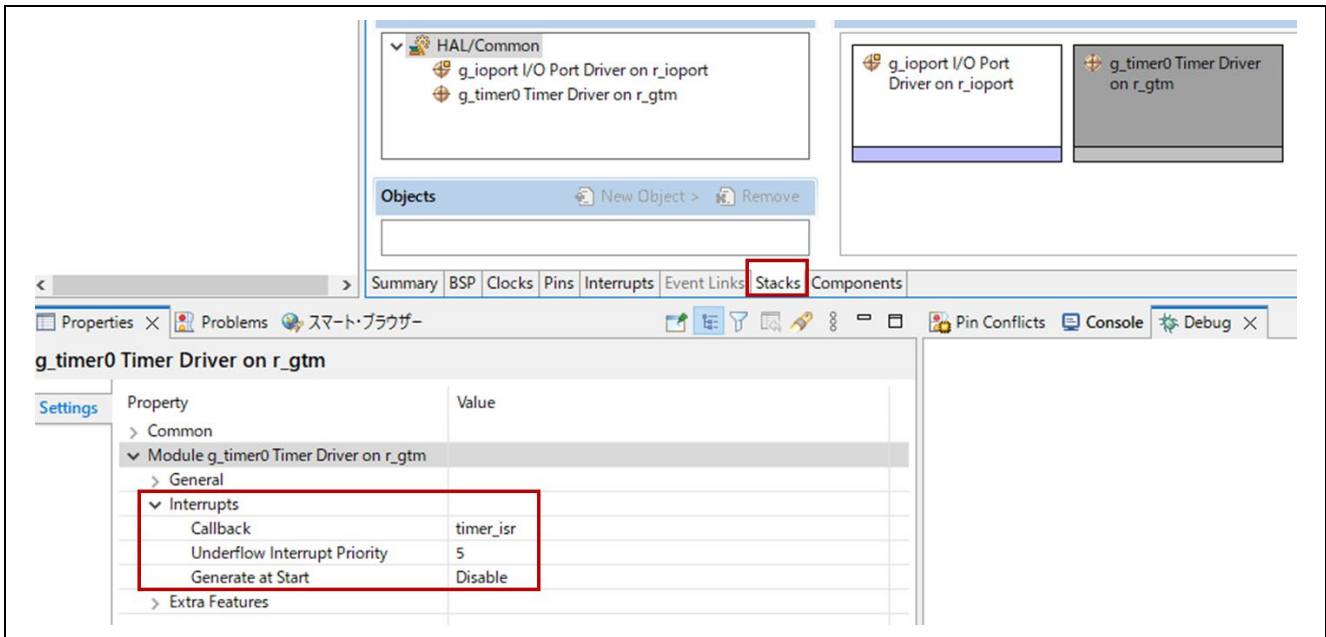

Figure 74 : Configuring Interrupts in the Stacks tab

5.2.6 Creating Interrupts from the Interrupts Tab

On the **Interrupts** tab, the user can bypass a peripheral interrupt set by the FSP by setting a user-defined ISR. This can be done by adding a new event via **New User Event** button.

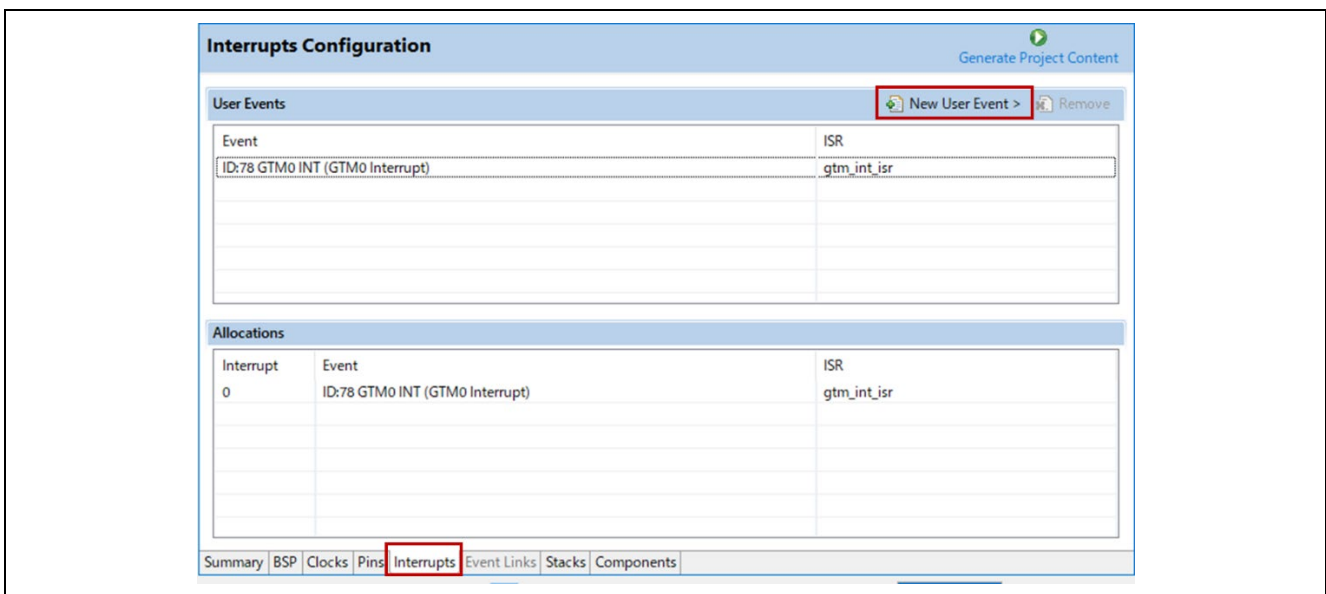

Figure 75 : Configuring interrupt in Interrupt Tab

5.2.7 Viewing Event Links

RZ/A FSP doesn't support **Event Links** tab, and it is grayed out.

5.2.8 Adding Threads and Drivers

Every RTOS-based RZ/A FSP Project includes at least one RTOS Thread and a stack of FSP module running in that thread. The **Stacks** tab is a graphical user interface which helps you to add the right modules to a thread and configure the properties of both the threads and the modules associated with each thread. Once you have configured the thread, e2 studio automatically generates the code reflecting your configuration choices.

For any driver, or, more generally, any module that you add to a thread, e2 studio automatically resolves all dependencies with other modules and creates the appropriate stack. This stack is displayed in the **Stacks** pane, which e2 studio populates with the selected modules and module options for the selected thread.

The default view of the **Stacks** tab includes a Common Thread called **HAL/Common**. This thread includes the driver for I/O control (IOPORT). The default stack is shown in the **HAL/Common Stacks** pane. The default modules added to the HAL/Common driver are special in that the FSP only requires a single instance of each, which e2 studio then includes in every user-defined thread by default.

In applications that do not use an RTOS or run outside of the RTOS, the HAL/Common thread becomes the default location where you can add additional drivers to your application.

For a detailed description on how to add and configure modules and stacks, see the following sections:

- [Adding and Configuring HAL Drivers](#)
- [Adding Drivers to a Thread and Configuring the Drivers](#)

Only you have added a module either to HAL/Common or to a new thread, you can access the driver's configuration options in the **Properties** view. If you added thread objects, you were able to access the objects configuration options in the **Properties** view in the same way.

5.2.9 Adding and Configuring HAL Drivers

For applications that run outside or without the RTOS, you can add additional HAL drivers to your application using the HAL/Common thread. To add drivers, follow these steps:

1. Click on the HAL/Common icon in the **Stacks** pane. The Modules pane changes to **HAL/Common Stacks**.
2. Click New Stack to see a drop-down list of HAL level drivers available in the FSP.
3. Select a driver from the menu **New Stack > Driver**.

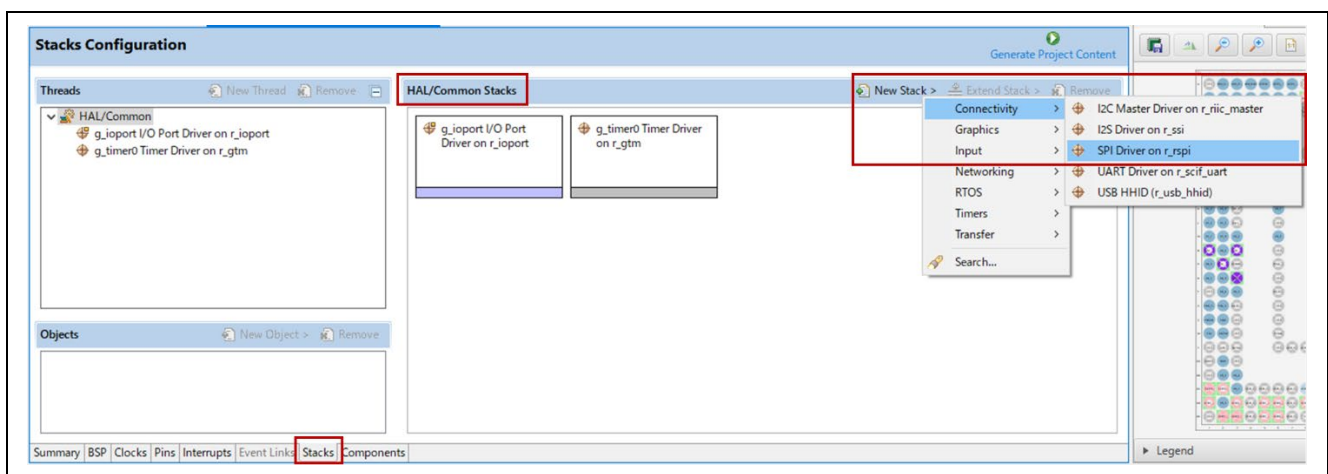

Figure 76 : e2 studio Project configurator - Adding drivers

4. Select the driver module in the **HAL/Common Modules** pane and configure the driver properties in the **Properties** view.

e2 studio adds the following files when you click the **Generate Project Content** button:

- The selected driver module and its files to the rza/fsp directory
- The main() function and configuration structures and header files for your application as shown in the table below.

File	Contents	Overwritten by Generate Project Content?
rza_gen/main.c	Contains main() calling generated and user code. When called, the BSP has already initialized the MPU	Yes
rza_gen/hal_data.c	Configuration structures for HAL Driver only modules	Yes
rza_gen/hal_data.h	Header file for HAL driver only modules	Yes
src/hal_entry.c	User entry point for HAL Driver only code. Add your code here	No
src/mmu_page_table.c	Virtual memory page table settings	No
src/sections.c	Rules for section transfer from ROM to RAM	No
src/syscalls.c	Low-level processing stub for file I/O functions	No

The configuration header files for all included modules are created or overwritten in the folder "rza_cfg/fsp_cfg".

5.2.10 Adding Drivers to a Thread and Configuring the Drivers

For an application that uses the RTOS, you can add one or more threads, and for each thread at least one module that runs in the thread. You can select modules from the Driver dropdown menu. To add modules to a thread, follow these steps:

1. In the **Threads** pane, click **New Thread** to add a Thread.

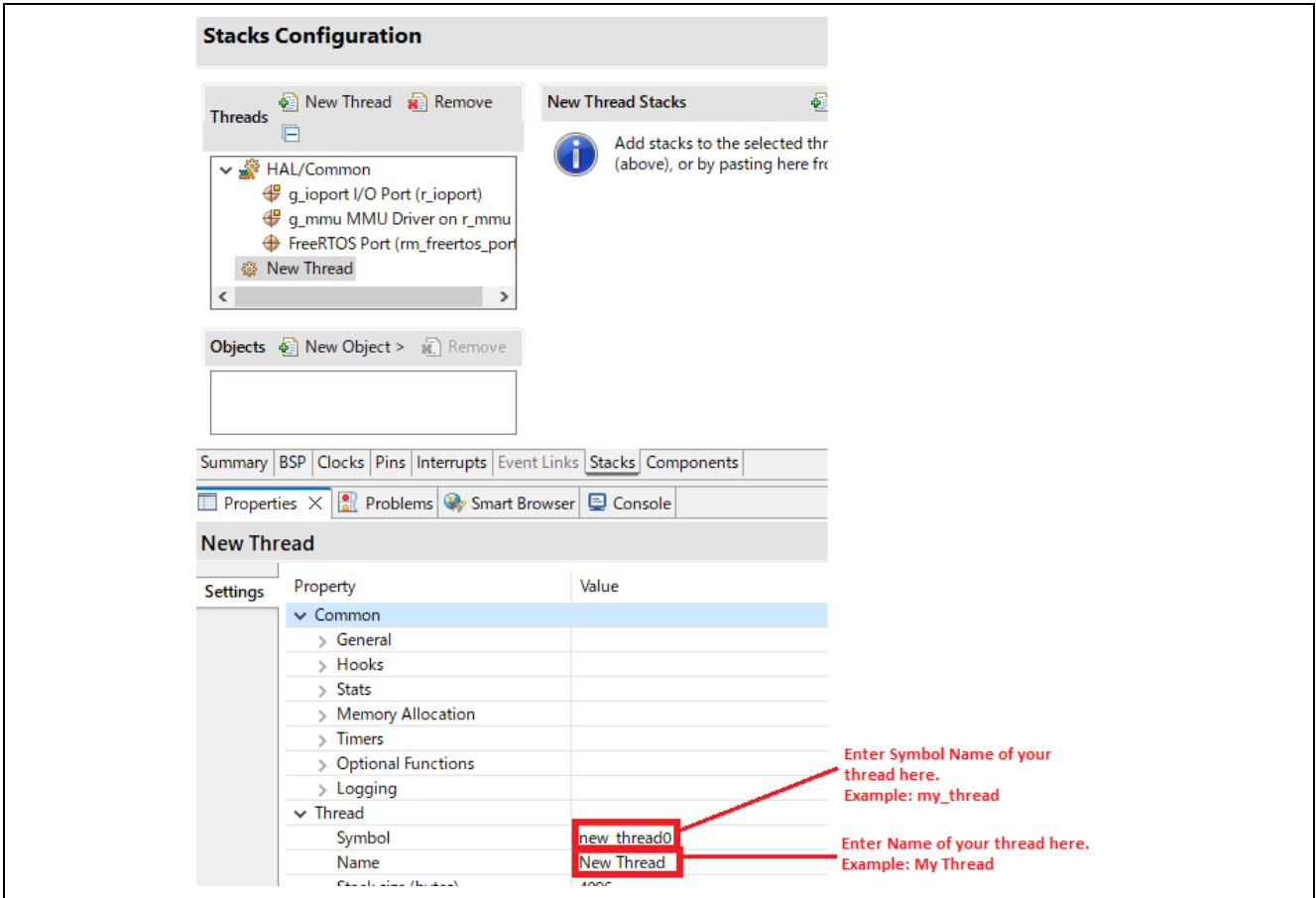

Figure 77 : Adding a new RTOS Thread on the Stack tab

2. In the properties view, click on the Name and Symbol entries and enter distinctive name and symbol for the new thread.

Note:

e2 studio updates the name of the thread stacks pane to **My Thread Stacks**.

3. In the **My Thread Stacks** pane, click on **New Stack** to see a list of modules and drivers.

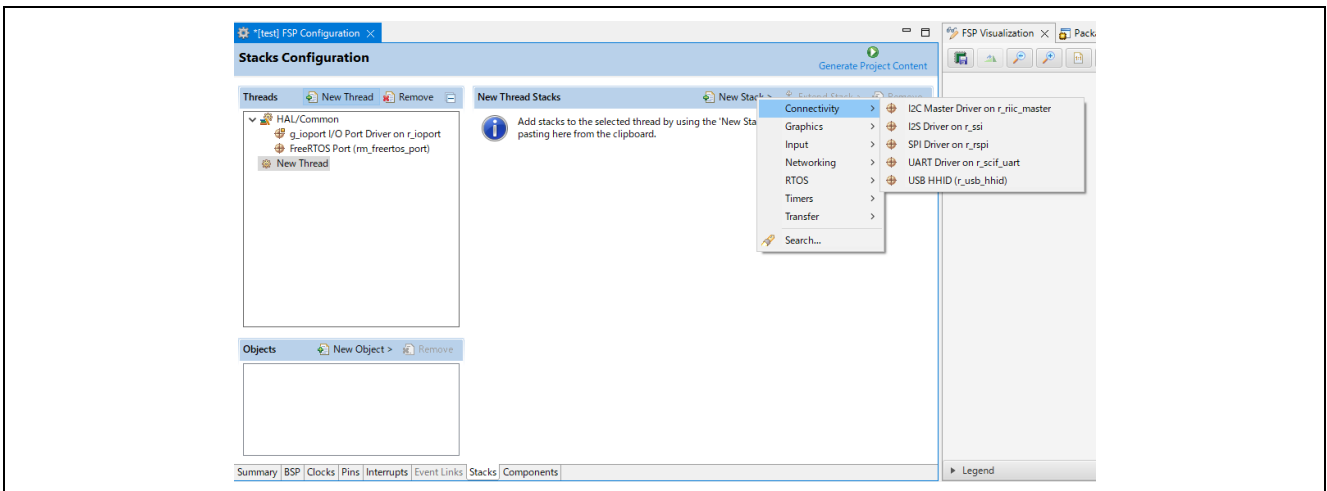

Figure 78 : Adding Modules and Drivers to a thread

4. Select a module or driver from the list.
5. Click on the added driver and configure the driver as required by the application by updating the configuration parameters in **Properties** view. To see the selected module or driver and be able to edit its properties, make sure the Thread containing the driver is highlighted in the **Threads** pane.

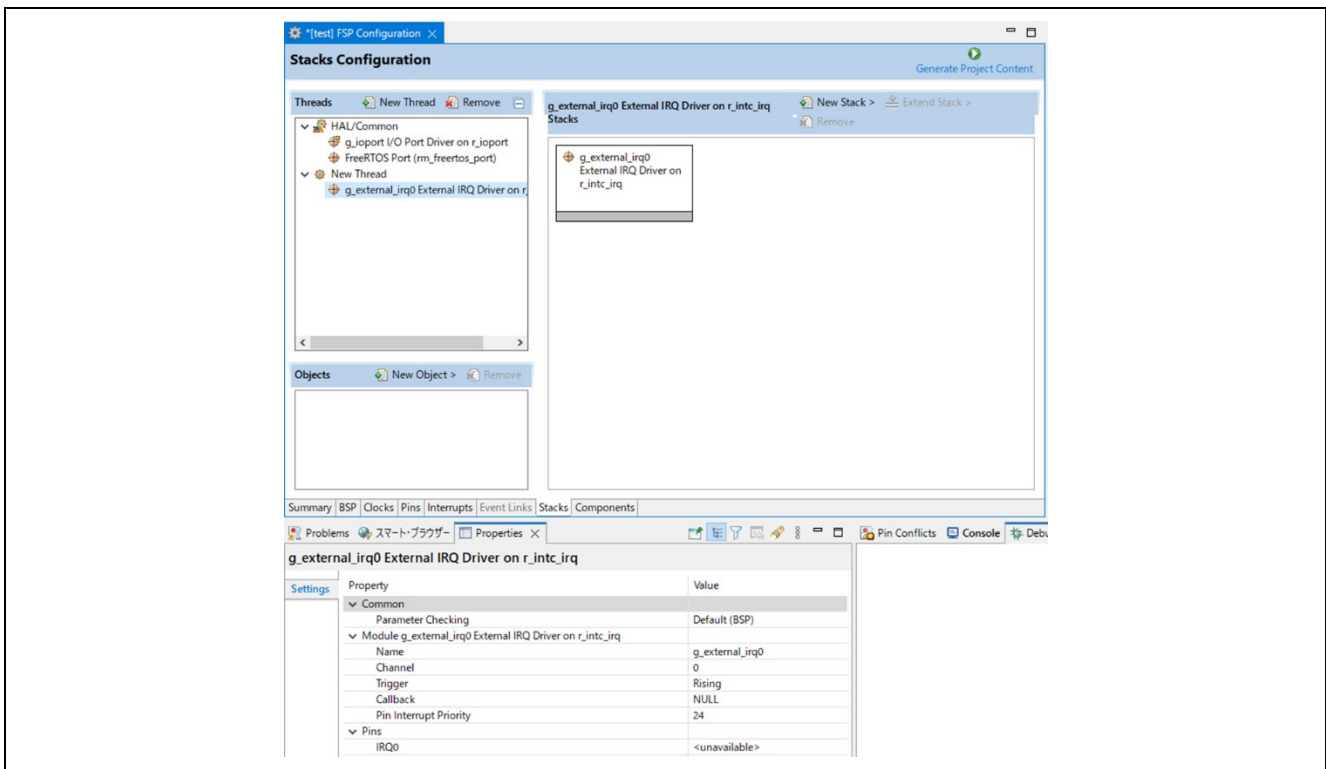

Figure 79 : Configuring Module or Driver properties

6. When you press the Generate Project Content button for the example above, e2 studio creates the files as shown in the following table:

File	Contents	Overwritten by Generate Project Content?
rza_gen/main.c	Contains main() calling generated and user code. When called, the BSP will have initialized the MPU.	Yes
rza_gen/my_thread.c	Generated thread "my_thread" and configuration structures for modules added to this thread.	Yes
rza_gen/my_thread.h	Header file for thread "my_thread"	Yes
rza_gen/hal_data.c	Configuration structures for HAL Driver only modules.	Yes
rza_gen/hal_data.h	Header file for HAL driver only modules.	Yes
src/hal_entry.c	User entry point for HAL Driver only code. Add your code here.	No
src/my_thread_entry.c	User entry point for thread "my_thread". Add your code here.	No

5.2.11 Configuring Threads

If the application uses an RTOS, the Stacks tab can be used to simplify the creation of RTOS threads, semaphores, mutexes, and event flags. The components of each thread can be configured from the **Properties** view as shown below:

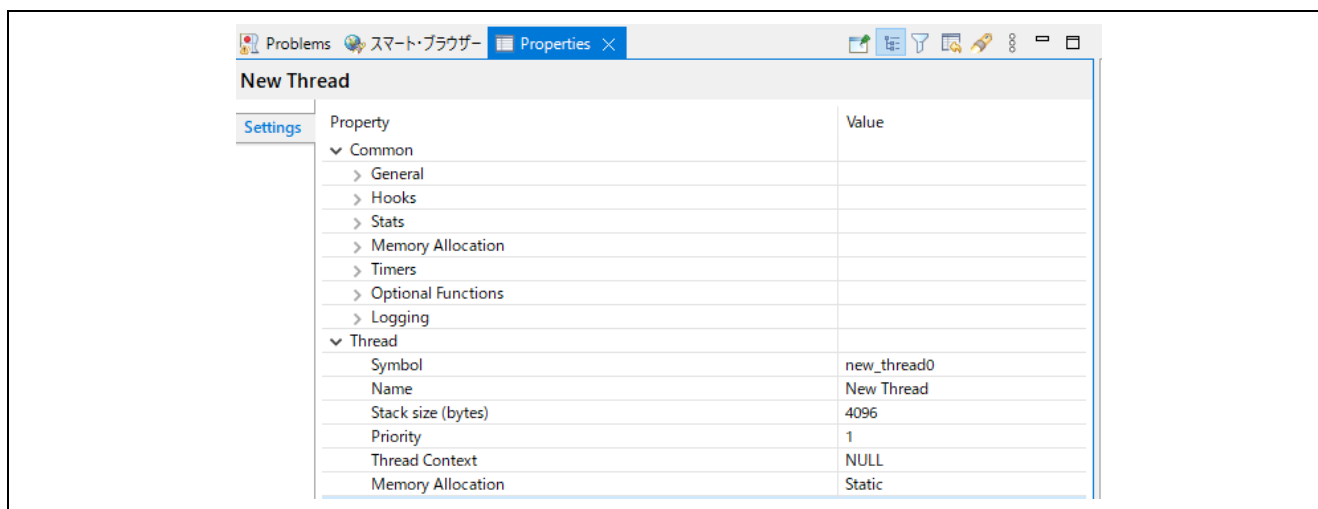

Figure 80 : New Thread Properties

The Properties view contains settings which are common for all Threads (**Common**) and settings for this particular thread (**Thread**).

For this thread instance, the thread's name and properties (such as priority level or stack size) can be easily configured. e2 studio checks that the entries in the property field are valid. For example, it will verify that the field **Priority**, which requires an integer value, only contains numeric values between 0 and 9.

To add RTOS resources to a Thread, select a thread and click on **New Object** in the Thread Objects pane. The pane takes on the name of the selected thread, in this case **My Thread Objects**.

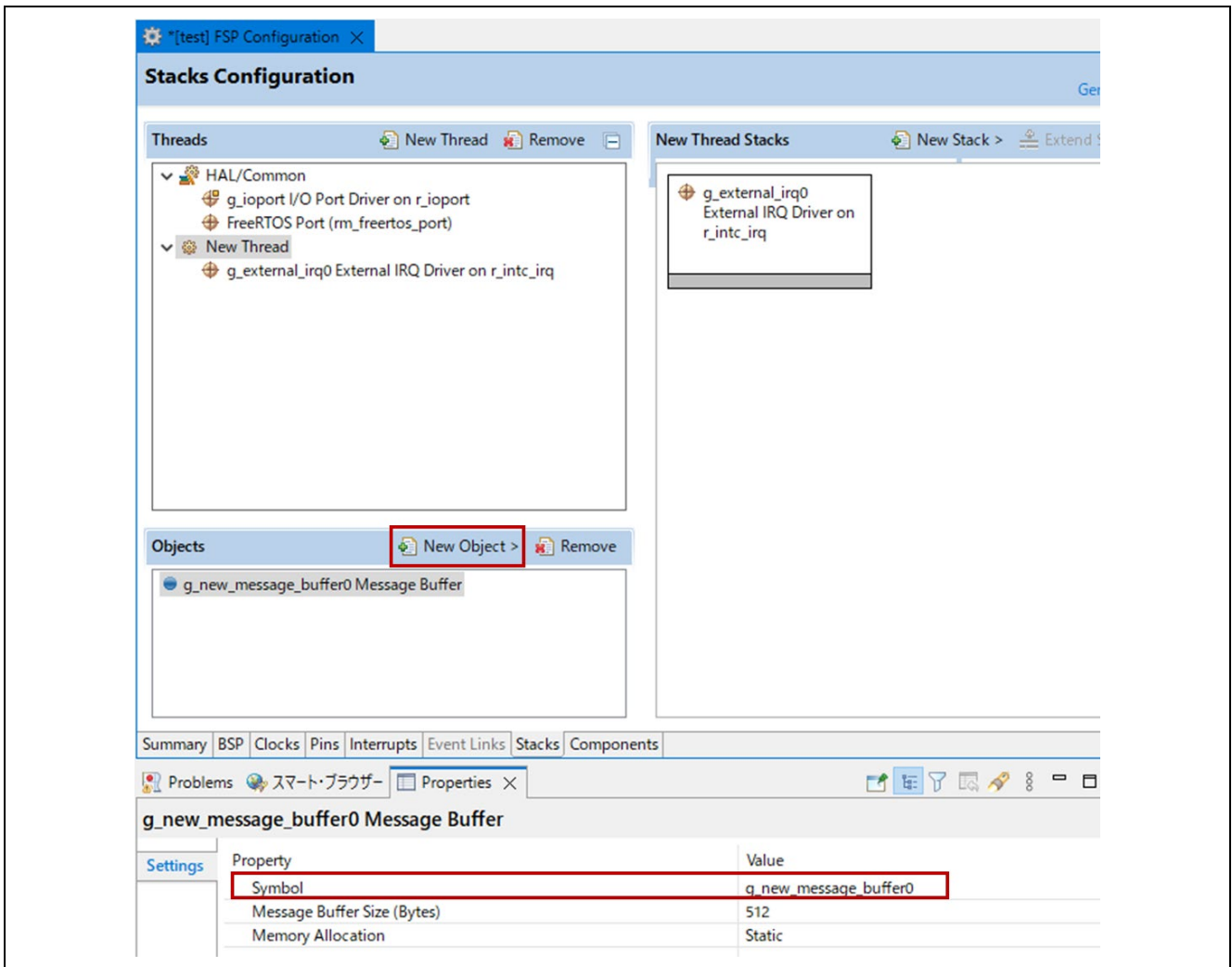

Figure 81 : Configuring Thread Object Properties

Make sure to give each thread object a unique symbol by updating the **Symbol** entries in the **Properties** view.

5.3 Reviewing and Adding Components

The **Components** tab enables the individual modules required by the application to be included or excluded. Modules common to all RZ/A MPU projects are preselected. All modules that are necessary for the modules selected in the **Stacks** tab are included automatically. You can include or exclude additional modules by ticking the box next to the required component.

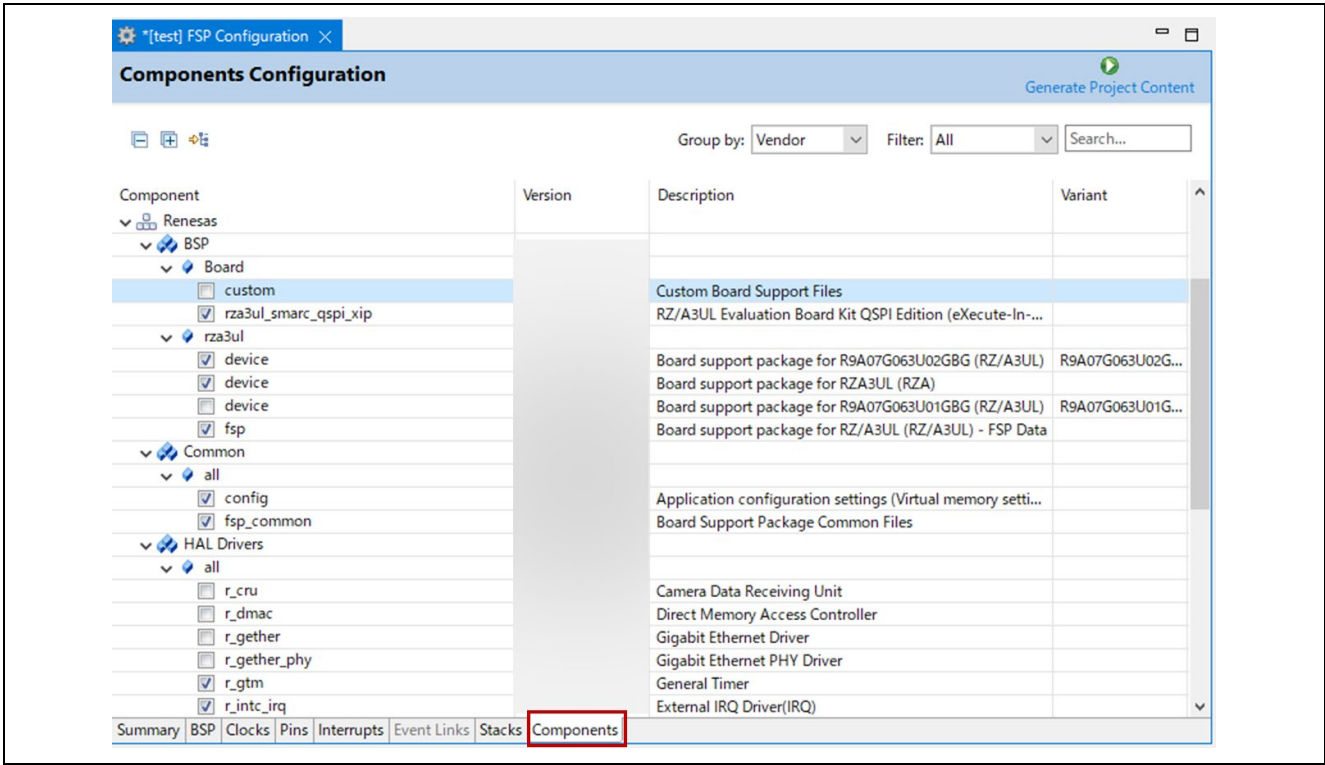

Figure 82 : Components Tab

By clicking the **Generate Project Content** button, the .c and .h files for each selected component are copied into the following folders:

- rza/fsp/inc/api
- rza/fsp/inc/instances
- rza/fsp/src/bsp
- rza/fsp/src/<Driver_Name>

e2 studio also creates configuration files in the rza_cfg/fsp_cfg folder with configuration options set in the **Stacks** tab.

5.4 Debugging the Project

Once your project builds without errors, you can use the Debugger to download your application to the board and execute it.

To debug an application, follow these steps:

1. On the drop-down list next to the debug icon, select **Debug Configurations**.

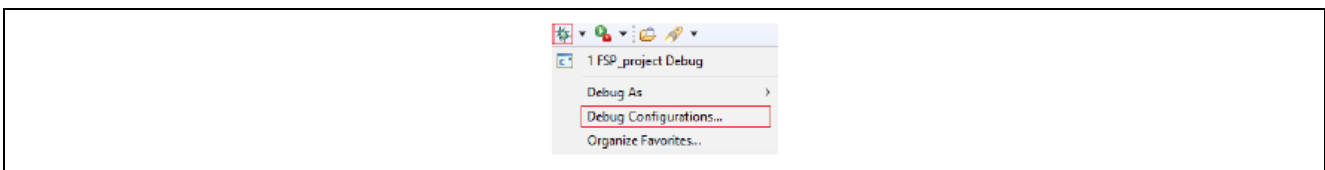

Figure 83 : Select of Debug Configurations

2. In the **Debug Configurations** view, click on your project listed as **MyProject Debug_Flat**.

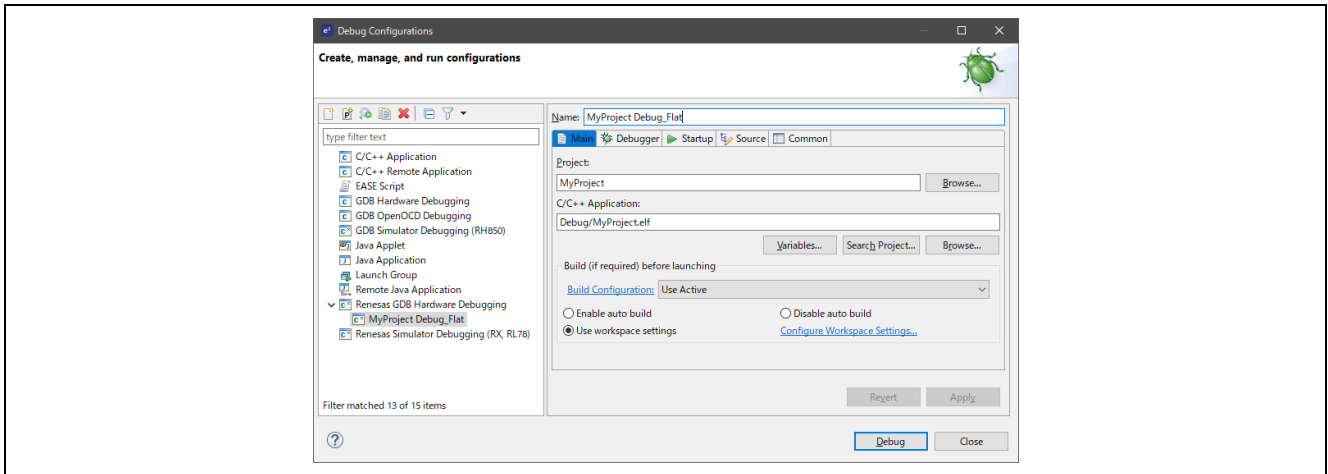

Figure 84 : Debug Configuration Window

3. Please set load images and set **Reset after download** setting to **Yes** as shown below:

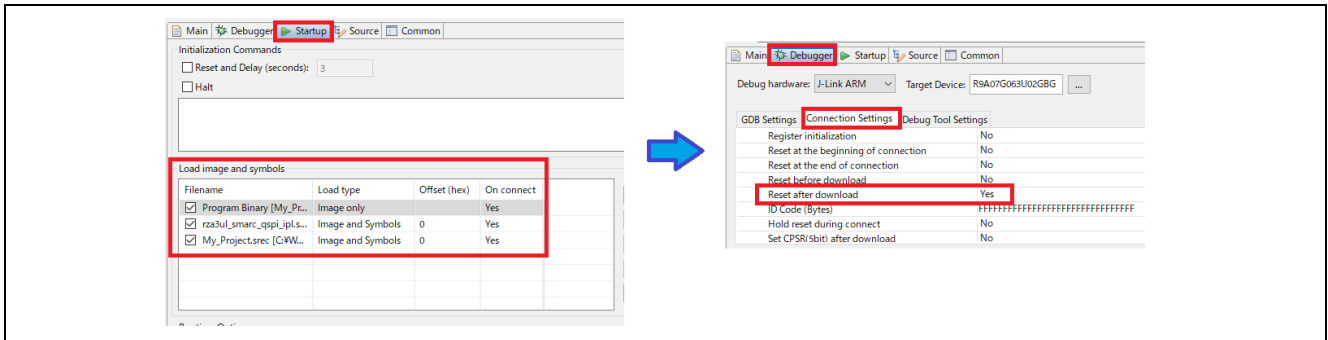

Figure 85 : Debug Setting

4. Connect the board to your PC via a standalone Segger J-Link debugger and click **Debug**.

Note:

For details on using J-Link and connecting the board to the PC, see 3.2.2.JTAG connection.

5.5 Modifying Toolchain Settings

There are instances where it may be necessary to make changes to the toolchain being used (for example, to change optimization level of the compiler or add a library to the linker). Such modifications can be made within e2 studio through the menu **Project > Properties > Settings** when the project is selected. The following screenshot shows the settings dialog for the GNU Arm toolchain. This dialog will look slightly different depending upon the toolchain being used.

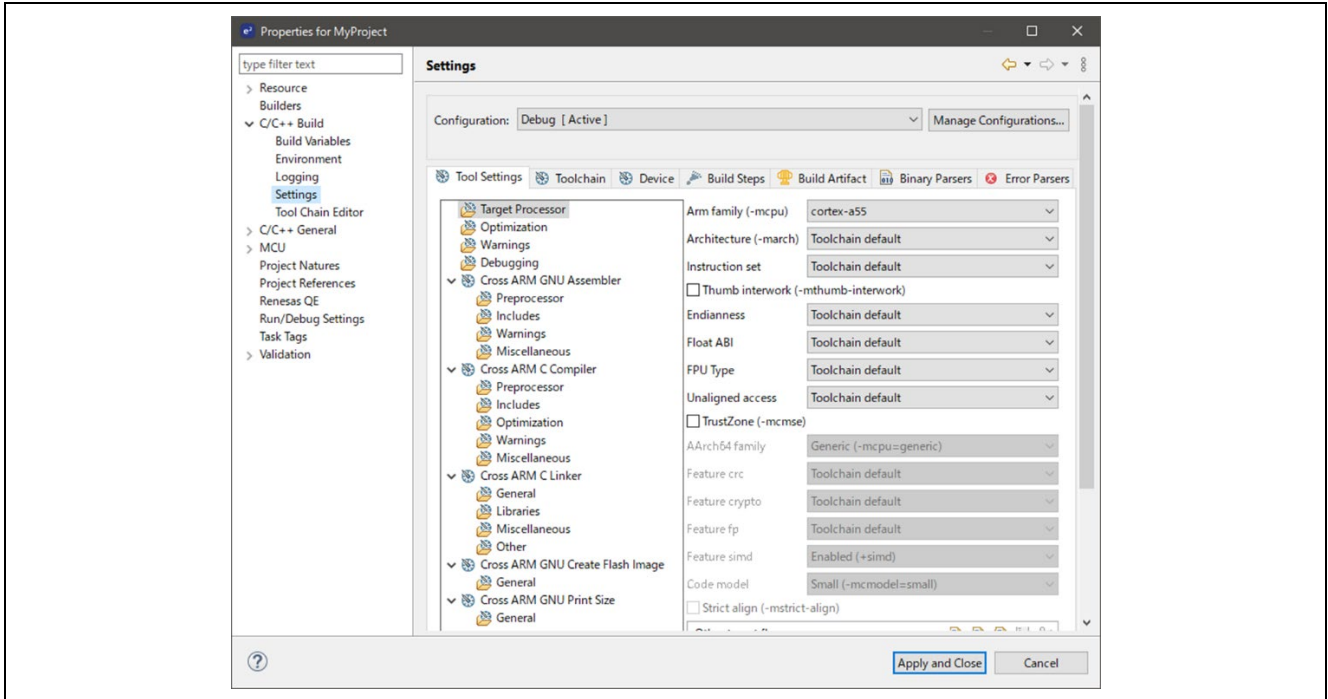

Figure 86 : e2 studio Project toolchain settings

The scope for the settings is project scope which means that the settings are valid only for the project being modified.

The settings for the linker which control the location of the various memory sections are contained in a script file specific for the device being used. This script file is included in the project when it is created and is found in the created project. (for example, script/rza3ul_smarc_qspi_xip.ld).

5.6 Importing an Existing Project into e2 studio

1. Launch e2 studio.
2. Open an existing Workspace to import the project and skip to step d. If the workspace does not exist, proceed with the following steps:
 - a. At the end of e2 studio startup, you will see the Workspace Launcher Dialog box as shown in the following figure.

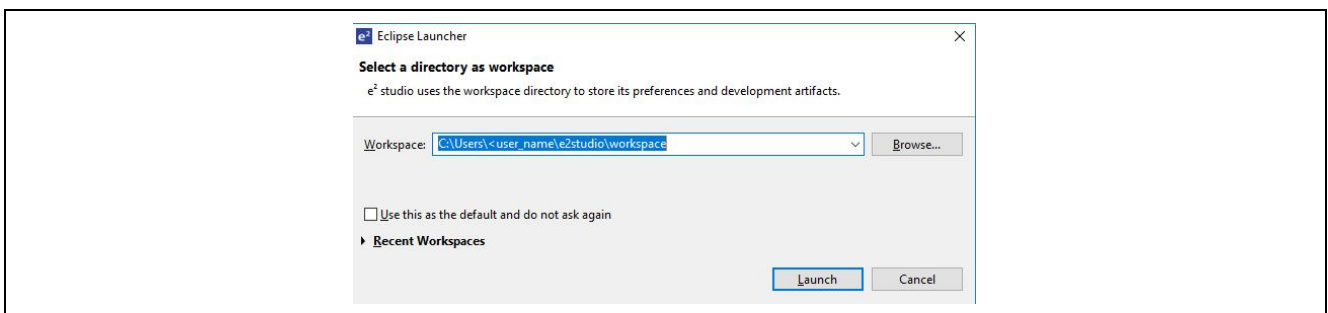

Figure 87 : Workspace Launcher dialog

- b. Enter a new workspace name in the Workspace Launcher Dialog as shown in the following figure. e2 studio creates a new workspace with this name.

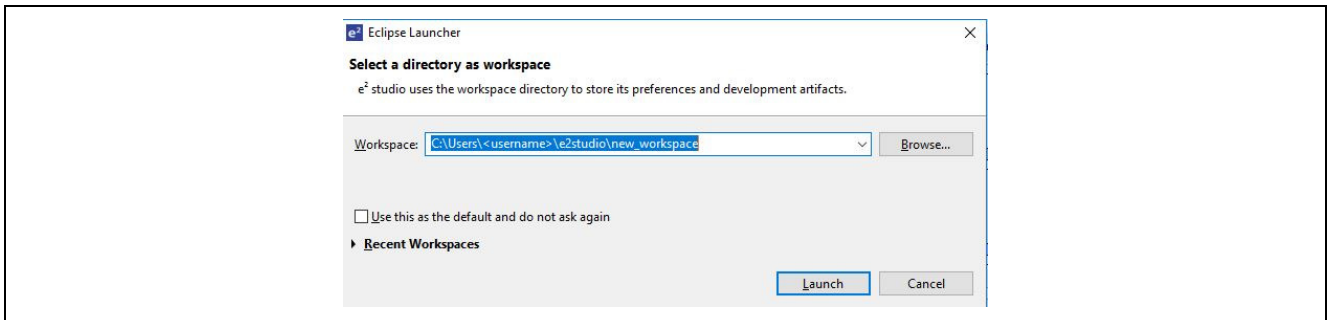

Figure 88 : Workspace Launcher dialog - Select Workspace

- c. Click [Launch].
- d. When the workspace is opened, you may see the Welcome Window. Click on the **Workbench** arrow button to proceed past the Welcome Screen as seen in the following figure.

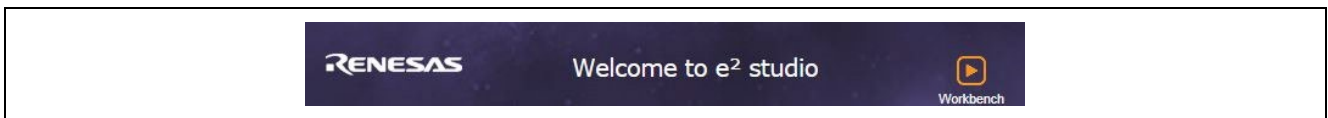

Figure 89 : Workbench arrow button

- 3. You are now in the workspace that you want to import the project into. Click the **File** menu in the menu bar, as shown in the following figure:

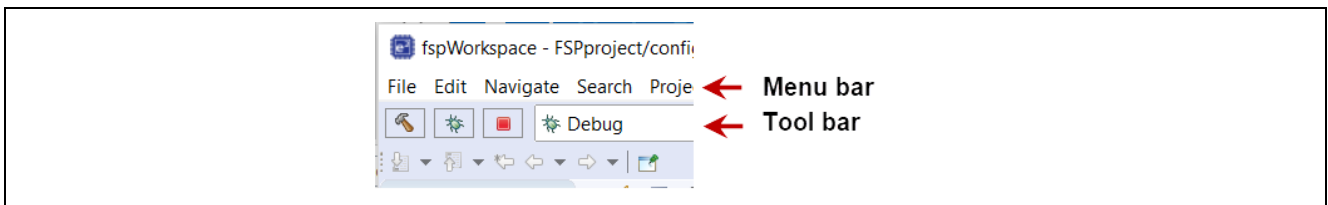

Figure 90 : Workbench arrow button

- 4. Click [Import] on the [File] menu or "Import project" on Project Explorer, as shown in the following figure:

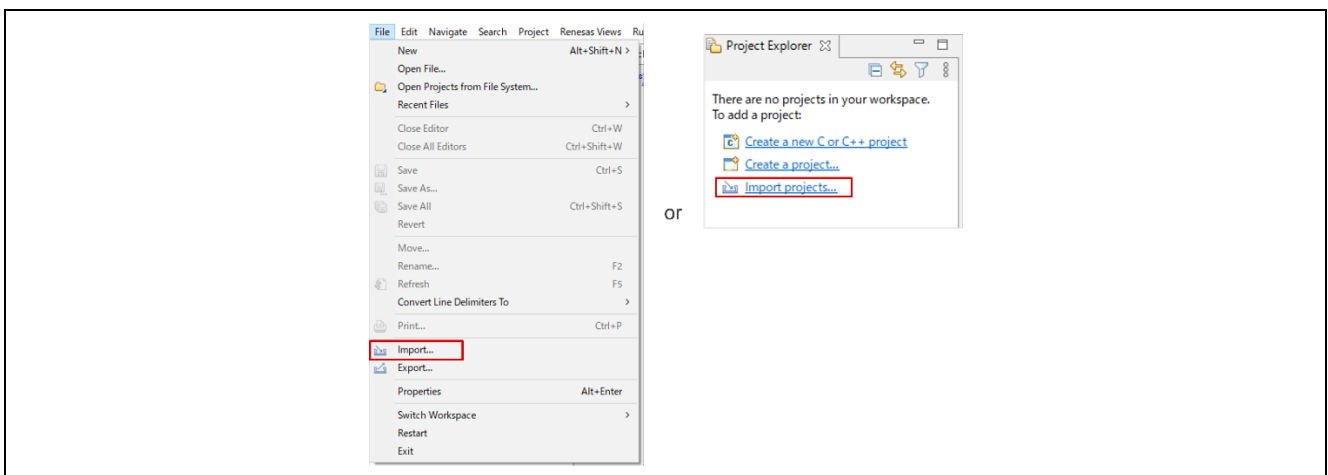

Figure 91 : File drop-down menu

5. In the **Import** dialog box, as shown in the following figure, choose the **General** option, then **Existing Projects into Workspace**, to import the project into the current workspace.

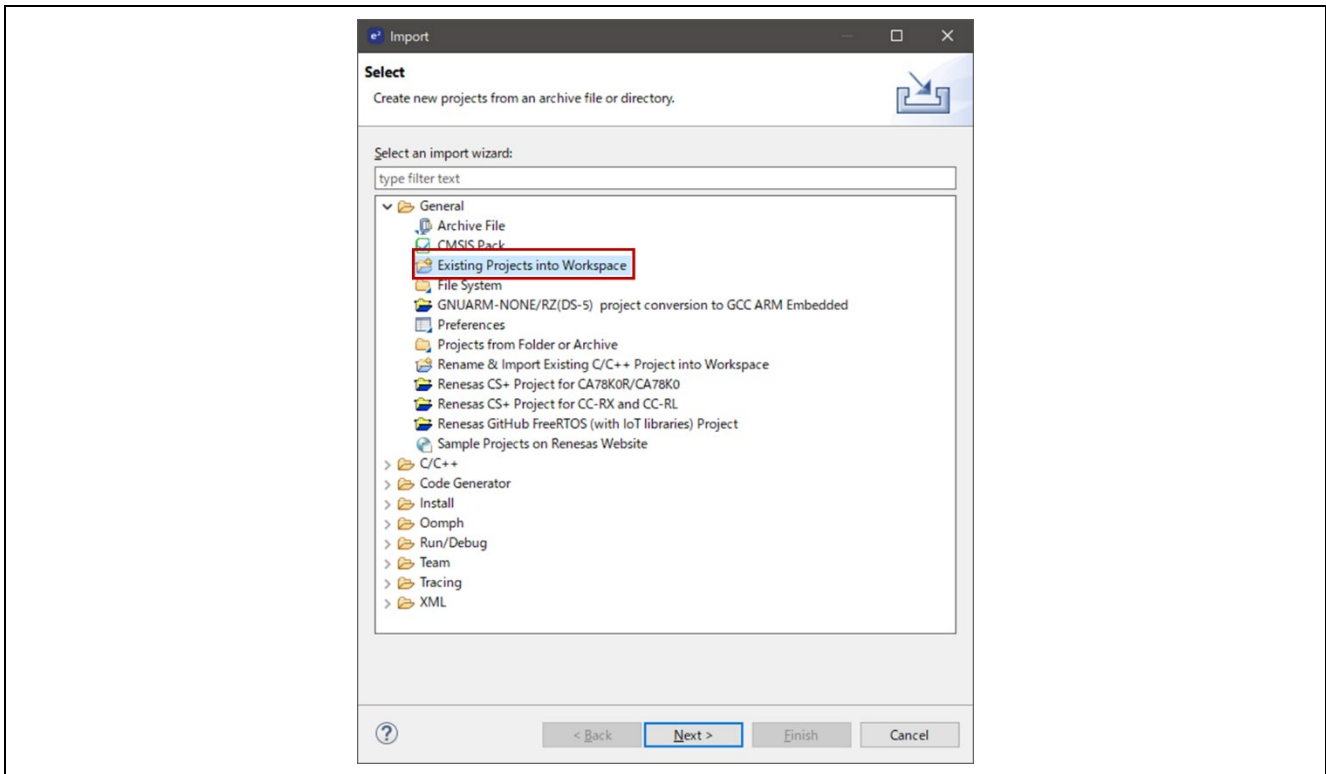

Figure 92 : Project Import dialog with "Existing Projects into Workspace" option selected

6. click [Next >]
 7. To import the project, use either **Select archive file** or **Select root directory**.
 First, choose **Select root directory** as shown below:

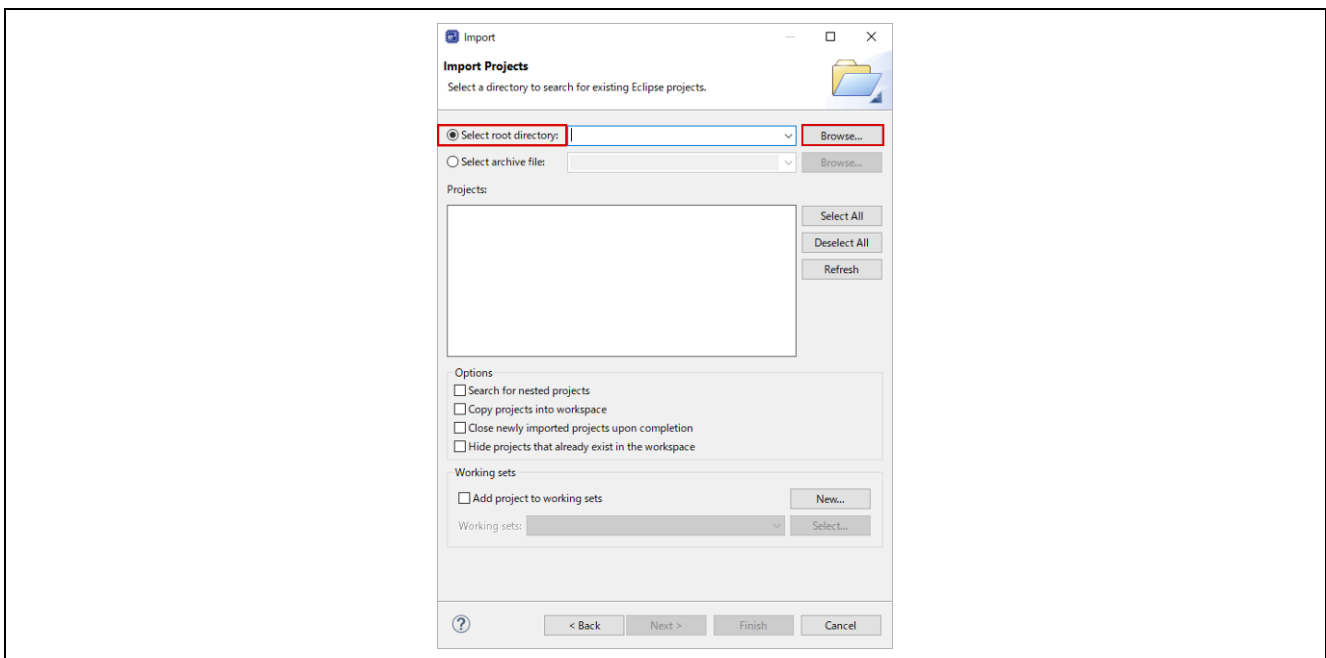

Figure 93 : Import Existing Project dialog 1 - Select root directory

8. Click [Browse...].
9. Choose the directory of the project you would like to import to specify the directory as **root directory**.
10. Select the project for import.
11. Click [Open].
12. Select the project to import from the list of [Projects:] as shown below:

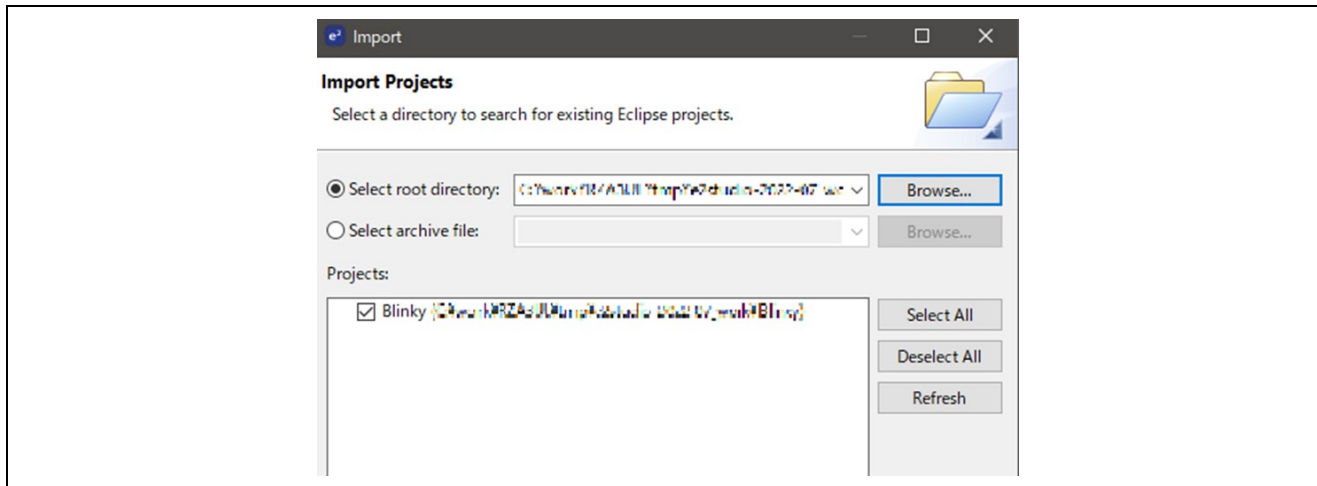

Figure 94 : Import Existing Project dialog 2 – Select the project to be imported

13. Click [Finish] to import the project.

6. Notes on development

6.1 Unexpected Update of Program placed on Flash ROM

If the program written to Flash ROM isn't updated expectedly even though there is no failure in downloading your program via e2studio, please check the settings of Flash Bus Type and Flash Memory Type shown in the figure below:

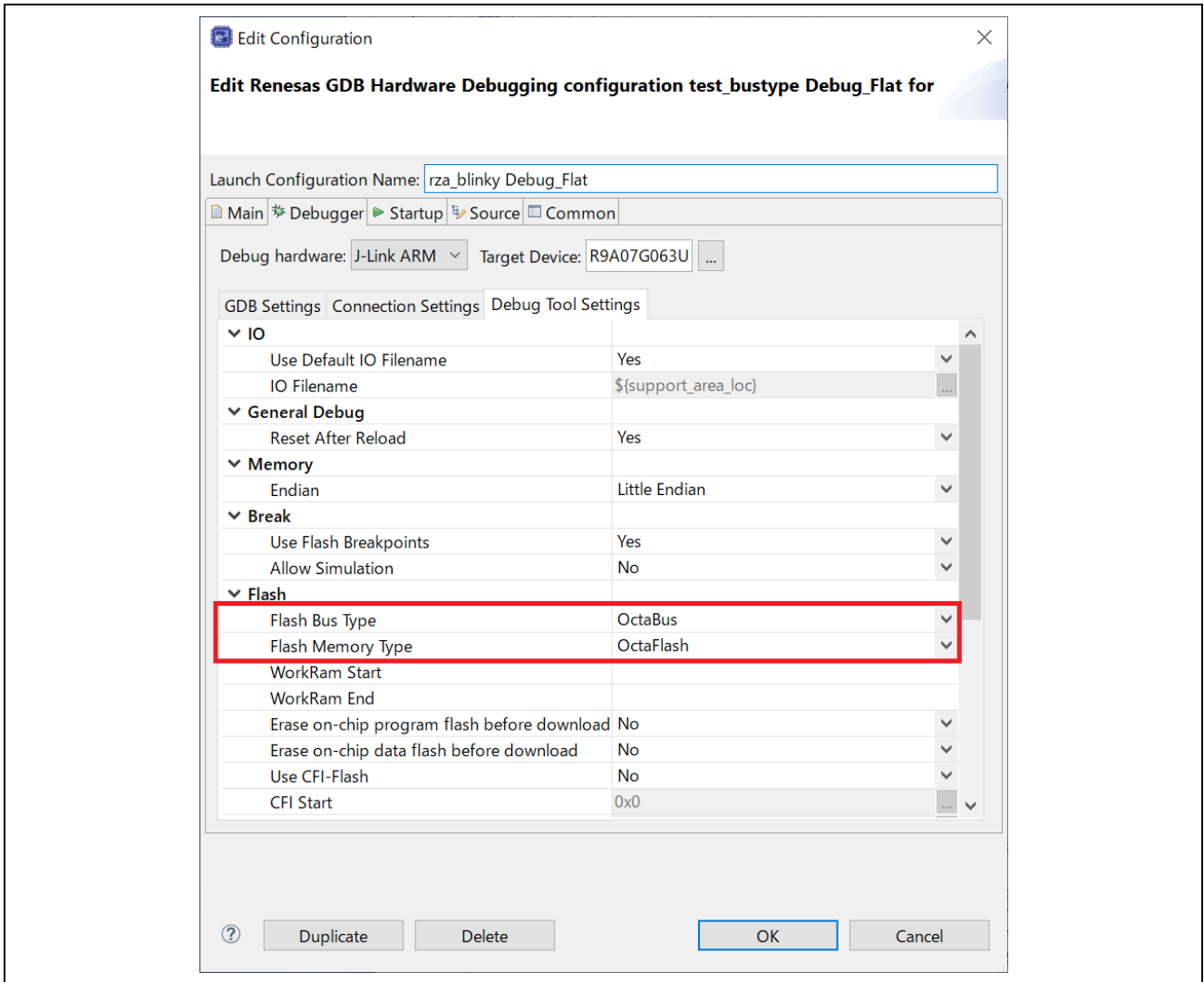

Figure 95 : Flash related settings in Debug Tool Settings

When Flash Bus Type and/or Flash Memory Type don't match the configuration of board shown in the following table, your program won't be downloaded properly.

Board Edition	Expected Flash Settings
QSPI Edition (RTK9763U02S01000BE)	<ul style="list-style-type: none"> Flash Bus Type : SPIBSC Flash Memory Type : SerialFlash
Octal-SPI Edition (RTK9763U02S01001BE)	<ul style="list-style-type: none"> Flash Bus Type : OctaBus Flash Memory Type : OctaFlash

6.2 Getting USB Hub to be workable with USBX

When using USB Hub with USBX, please follow the pro shown below:

1. Copy `rza/microsoft/azure-rtos/usbx/common/core/inc/ux_user_sample.h` to the directory `rza/fsp/src/rm_usb_port` and rename it to `ux_user.h`.
2. Add the definitions listed below to `ux_user.h`.

```
#define UX_MAX_CLASS_DRIVER    3
#define UX_MAX_ED              80
#define UX_MAX_TD              128
#define UX_MAX_ISO_TD         128
```

3. Add the following definition to `rza_azurertos_sample/rza/fsp/src/rm_usb_port/ux_port.h`.

```
#define UX_INCLUDE_USER_DEFINE_FILE
```

Revision History

Rev.	Date	Description	
		Page	Summary
3.1.0	Jul.31.2024	6 to 29, 34, 37, 44 to 45, 50, 52, 54 to 55	Updated the description and figure based on the latest development environment.
		40 to 42	Corrected the debug step when using the OCTAL Edition of the SMARC EVK board.
3.0.0	Apr.26.2024	6 to 29, 32 to 36, 47 to 53	Updated the description and figure based on the latest development environment.
2.0.2	Feb.29.2024	15, 36, 72, 73	Added 2.2 to install Arm GNU toolchain. Added Step 4 and 5 to 4.5.2. Removed 6.1 Unexpected termination of GDB connection. Removed 6.3 to describe the way to fix the building error.
2.0.1	Sep.30.2023	-	Updated the versions.
2.0.0	Jun.30.2023	63, 67	Added 6.3 to describe the way to fix the building error. Added 6.4 to describe the way to use USBX.
1.21	Apr.07.2023	22, 23	Added 2.2.3 to describe the way to install FSP with the zipped Packs.
1.20	Dec.26.2022	-	Added the instructions for installing FSP using Platform Installer.
1.10	Sep.30.2022	-	Added the info on "RZ/A3UL Evaluation Board Kit Octal-SPI Edition.
1.00	Jul.28.2022	-	First edition issued

General Precautions in the Handling of Microprocessing Unit and Microcontroller Unit Products

The following usage notes are applicable to all Microprocessing unit and Microcontroller unit products from Renesas. For detailed usage notes on the products covered by this document, refer to the relevant sections of the document as well as any technical updates that have been issued for the products.

1. Precaution against Electrostatic Discharge (ESD)

A strong electrical field, when exposed to a CMOS device, can cause destruction of the gate oxide and ultimately degrade the device operation. Steps must be taken to stop the generation of static electricity as much as possible, and quickly dissipate it when it occurs. Environmental control must be adequate. When it is dry, a humidifier should be used. This is recommended to avoid using insulators that can easily build up static electricity.

Semiconductor devices must be stored and transported in an anti-static container, static shielding bag or conductive material. All test and measurement tools including work benches and floors must be grounded. The operator must also be grounded using a wrist strap. Semiconductor devices must not be touched with bare hands. Similar precautions must be taken for printed circuit boards with mounted semiconductor devices.

2. Processing at power-on

The state of the product is undefined at the time when power is supplied. The states of internal circuits in the LSI are indeterminate and the states of register settings and pins are undefined at the time when power is supplied. In a finished product where the reset signal is applied to the external reset pin, the states of pins are not guaranteed from the time when power is supplied until the reset process is completed. In a similar way, the states of pins in a product that is reset by an on-chip power-on reset function are not guaranteed from the time when power is supplied until the power reaches the level at which resetting is specified.

3. Input of signal during power-off state

Do not input signals or an I/O pull-up power supply while the device is powered off. The current injection that results from input of such a signal or I/O pull-up power supply may cause malfunction and the abnormal current that passes in the device at this time may cause degradation of internal elements. Follow the guideline for input signal during power-off state as described in your product documentation.

4. Handling of unused pins

Handle unused pins in accordance with the directions given under handling of unused pins in the manual. The input pins of CMOS products are generally in the high-impedance state. In operation with an unused pin in the open-circuit state, extra electromagnetic noise is induced in the vicinity of the LSI, an associated shoot-through current flows internally, and malfunctions occur due to the false recognition of the pin state as an input signal become possible.

5. Clock signals

After applying a reset, only release the reset line after the operating clock signal becomes stable. When switching the clock signal during program execution, wait until the target clock signal is stabilized. When the clock signal is generated with an external resonator or from an external oscillator during a reset, ensure that the reset line is only released after full stabilization of the clock signal. Additionally, when switching to a clock signal produced with an external resonator or by an external oscillator while program execution is in progress, wait until the target clock signal is stable.

6. Voltage application waveform at input pin

Waveform distortion due to input noise or a reflected wave may cause malfunction. If the input of the CMOS device stays in the area between V_{IL} (Max.) and V_{IH} (Min.) due to noise, for example, the device may malfunction. Take care to prevent chattering noise from entering the device when the input level is fixed, and also in the transition period when the input level passes through the area between V_{IL} (Max.) and V_{IH} (Min.).

7. Prohibition of access to reserved addresses

Access to reserved addresses is prohibited. The reserved addresses are provided for possible future expansion of functions. Do not access these addresses as the correct operation of the LSI is not guaranteed.

8. Differences between products

Before changing from one product to another, for example to a product with a different part number, confirm that the change will not lead to problems. The characteristics of a microprocessing unit or microcontroller unit products in the same group but having a different part number might differ in terms of internal memory capacity, layout pattern, and other factors, which can affect the ranges of electrical characteristics, such as characteristic values, operating margins, immunity to noise, and amount of radiated noise. When changing to a product with a different part number, implement a system-evaluation test for the given product.

Notice

1. Descriptions of circuits, software and other related information in this document are provided only to illustrate the operation of semiconductor products and application examples. You are fully responsible for the incorporation or any other use of the circuits, software, and information in the design of your product or system. Renesas Electronics disclaims any and all liability for any losses and damages incurred by you or third parties arising from the use of these circuits, software, or information.
2. Renesas Electronics hereby expressly disclaims any warranties against and liability for infringement or any other claims involving patents, copyrights, or other intellectual property rights of third parties, by or arising from the use of Renesas Electronics products or technical information described in this document, including but not limited to, the product data, drawings, charts, programs, algorithms, and application examples.
3. No license, express, implied or otherwise, is granted hereby under any patents, copyrights or other intellectual property rights of Renesas Electronics or others.
4. You shall be responsible for determining what licenses are required from any third parties, and obtaining such licenses for the lawful import, export, manufacture, sales, utilization, distribution or other disposal of any products incorporating Renesas Electronics products, if required.
5. You shall not alter, modify, copy, or reverse engineer any Renesas Electronics product, whether in whole or in part. Renesas Electronics disclaims any and all liability for any losses or damages incurred by you or third parties arising from such alteration, modification, copying or reverse engineering.
6. Renesas Electronics products are classified according to the following two quality grades: "Standard" and "High Quality". The intended applications for each Renesas Electronics product depends on the product's quality grade, as indicated below.
 - "Standard": Computers; office equipment; communications equipment; test and measurement equipment; audio and visual equipment; home electronic appliances; machine tools; personal electronic equipment; industrial robots; etc.
 - "High Quality": Transportation equipment (automobiles, trains, ships, etc.); traffic control (traffic lights); large-scale communication equipment; key financial terminal systems; safety control equipment; etc.

Unless expressly designated as a high reliability product or a product for harsh environments in a Renesas Electronics data sheet or other Renesas Electronics document, Renesas Electronics products are not intended or authorized for use in products or systems that may pose a direct threat to human life or bodily injury (artificial life support devices or systems; surgical implantations; etc.), or may cause serious property damage (space system; undersea repeaters; nuclear power control systems; aircraft control systems; key plant systems; military equipment; etc.). Renesas Electronics disclaims any and all liability for any damages or losses incurred by you or any third parties arising from the use of any Renesas Electronics product that is inconsistent with any Renesas Electronics data sheet, user's manual or other Renesas Electronics document.
7. No semiconductor product is absolutely secure. Notwithstanding any security measures or features that may be implemented in Renesas Electronics hardware or software products, Renesas Electronics shall have absolutely no liability arising out of any vulnerability or security breach, including but not limited to any unauthorized access to or use of a Renesas Electronics product or a system that uses a Renesas Electronics product. RENESAS ELECTRONICS DOES NOT WARRANT OR GUARANTEE THAT RENESAS ELECTRONICS PRODUCTS, OR ANY SYSTEMS CREATED USING RENESAS ELECTRONICS PRODUCTS WILL BE INVULNERABLE OR FREE FROM CORRUPTION, ATTACK, VIRUSES, INTERFERENCE, HACKING, DATA LOSS OR THEFT, OR OTHER SECURITY INTRUSION ("Vulnerability Issues"). RENESAS ELECTRONICS DISCLAIMS ANY AND ALL RESPONSIBILITY OR LIABILITY ARISING FROM OR RELATED TO ANY VULNERABILITY ISSUES. FURTHERMORE, TO THE EXTENT PERMITTED BY APPLICABLE LAW, RENESAS ELECTRONICS DISCLAIMS ANY AND ALL WARRANTIES, EXPRESS OR IMPLIED, WITH RESPECT TO THIS DOCUMENT AND ANY RELATED OR ACCOMPANYING SOFTWARE OR HARDWARE, INCLUDING BUT NOT LIMITED TO THE IMPLIED WARRANTIES OF MERCHANTABILITY, OR FITNESS FOR A PARTICULAR PURPOSE.
8. When using Renesas Electronics products, refer to the latest product information (data sheets, user's manuals, application notes, "General Notes for Handling and Using Semiconductor Devices" in the reliability handbook, etc.), and ensure that usage conditions are within the ranges specified by Renesas Electronics with respect to maximum ratings, operating power supply voltage range, heat dissipation characteristics, installation, etc. Renesas Electronics disclaims any and all liability for any malfunctions, failure or accident arising out of the use of Renesas Electronics products outside of such specified ranges.
9. Although Renesas Electronics endeavors to improve the quality and reliability of Renesas Electronics products, semiconductor products have specific characteristics, such as the occurrence of failure at a certain rate and malfunctions under certain use conditions. Unless designated as a high reliability product or a product for harsh environments in a Renesas Electronics data sheet or other Renesas Electronics document, Renesas Electronics products are not subject to radiation resistance design. You are responsible for implementing safety measures to guard against the possibility of bodily injury, injury or damage caused by fire, and/or danger to the public in the event of a failure or malfunction of Renesas Electronics products, such as safety design for hardware and software, including but not limited to redundancy, fire control and malfunction prevention, appropriate treatment for aging degradation or any other appropriate measures. Because the evaluation of microcomputer software alone is very difficult and impractical, you are responsible for evaluating the safety of the final products or systems manufactured by you.
10. Please contact a Renesas Electronics sales office for details as to environmental matters such as the environmental compatibility of each Renesas Electronics product. You are responsible for carefully and sufficiently investigating applicable laws and regulations that regulate the inclusion or use of controlled substances, including without limitation, the EU RoHS Directive, and using Renesas Electronics products in compliance with all these applicable laws and regulations. Renesas Electronics disclaims any and all liability for damages or losses occurring as a result of your noncompliance with applicable laws and regulations.
11. Renesas Electronics products and technologies shall not be used for or incorporated into any products or systems whose manufacture, use, or sale is prohibited under any applicable domestic or foreign laws or regulations. You shall comply with any applicable export control laws and regulations promulgated and administered by the governments of any countries asserting jurisdiction over the parties or transactions.
12. It is the responsibility of the buyer or distributor of Renesas Electronics products, or any other party who distributes, disposes of, or otherwise sells or transfers the product to a third party, to notify such third party in advance of the contents and conditions set forth in this document.
13. This document shall not be reprinted, reproduced or duplicated in any form, in whole or in part, without prior written consent of Renesas Electronics.
14. Please contact a Renesas Electronics sales office if you have any questions regarding the information contained in this document or Renesas Electronics products.

(Note1) "Renesas Electronics" as used in this document means Renesas Electronics Corporation and also includes its directly or indirectly controlled subsidiaries.

(Note2) "Renesas Electronics product(s)" means any product developed or manufactured by or for Renesas Electronics.

(Rev.5.0-1 October 2020)

Corporate Headquarters

TOYOSU FORESIA, 3-2-24 Toyosu,
Koto-ku, Tokyo 135-0061, Japan
www.renesas.com

Trademarks

Renesas and the Renesas logo are trademarks of Renesas Electronics Corporation. All trademarks and registered trademarks are the property of their respective owners.

Contact information

For further information on a product, technology, the most up-to-date version of a document, or your nearest sales office, please visit:
www.renesas.com/contact/.