

RTKA-BDGSTKDBEVKIT1Z

User's Manual: Evaluation Kit

Industrial Analog and Power

All information contained in these materials, including products and product specifications, represents information on the product at the time of publication and is subject to change by Renesas Electronics Corp. without notice. Please review the latest information published by Renesas Electronics Corp. through various means, including the Renesas Electronics Corp. website (<http://www.renesas.com>).

RTKA-BDGSTKDBEVKIT1Z

Evaluation Kit

This user manual shows the operation of Renesas precision products in a pressure sensor application. The application uses the Renesas Data Acquisition (DAQ) on a Stick reference design with Honeywell's NBP Series-Uncompensated/Unamplified 0_{psi} to 30_{psi} basic board mount pressure sensor.

The reference design is a self-contained demo showing a complete signal chain solution from the Honeywell sensor, signal conditioning using Renesas precision parts, and a Renesas microcontroller. The complete reference design is conveniently housed in a USB stick form factor with a plug in sensor board. This compact design draws power through the USB port and uses a Graphical User Interface (GUI) to display the real-time voltage readings from the pressure sensor. [Figure 1](#) shows the DAQ on a Stick connected to an external pressure sensor. Pressure is applied to the Honeywell sensor with a syringe.

[Figure 2](#) shows a simplified schematic of the pressure sensor design. The design uses the Honeywell NBPLLNN030PGUNV 0_{psi} to 30_{psi} basic board mount pressure sensor, the Renesas ISL28134 chopper amplifier, ISL22316 Digitally Controlled Potentiometer (DCP), ISL43840 dual 4-channel Mux configured as a Differential Mux, ISL21010 3.3V and 4.096V precision voltage references, ISL26102 24-bit delta sigma converter, and R5F10JBC microcontroller.

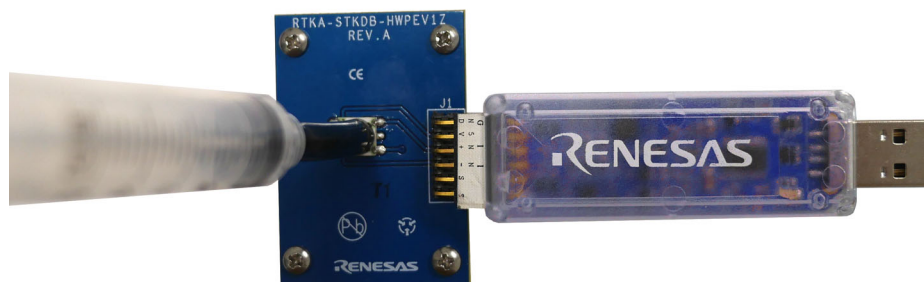

Figure 1. DAQ on a Stick with Honeywell Pressure Sensor

Ordering Information

Part Number	Description
RTKA-BDGSTKDBEVKIT1Z	Kit Includes: RTKA-BDGSTKEV2Z (DAQ on a Stick Evaluation Board) RTKA-STKDB-HWPEV1Z (Pressure Sensor Board)

Related Literature

For a full list of related documents, visit our website:

- [ISL28134](#), [ISL21010](#), [ISL26102](#), [ISL43840](#), [ISL22316](#), and [R5F10JBC](#) device pages
- Honeywell [NBPLLNN030PGUNV](#) pressure sensor

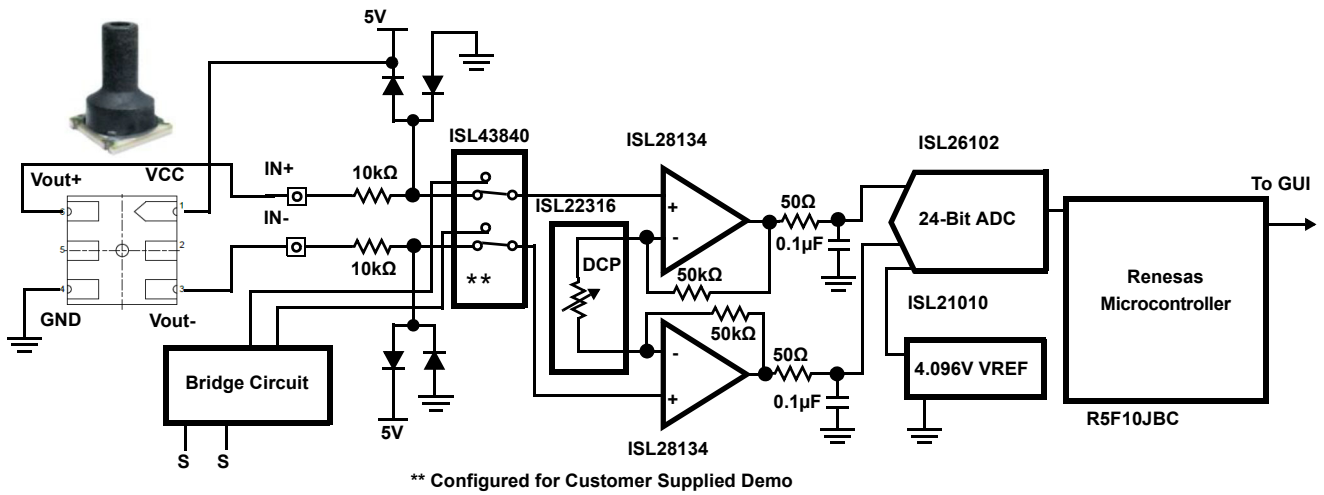

Figure 2. Simplified Pressure Gauge Schematic

1. Getting Started

1.1 Installing the Software and USB Drivers

The software and USB drivers must be installed on a PC running Windows NT/2000/XP/Vista/Win7/Win 8/Win 10 operating system before connecting the RTKA-BDGSTKEV2Z/RTKA-STKDB-HWPEV1Z boards to the USB port.

The software and a short video on the operation of this application demonstration can be downloaded or viewed from the Renesas [website](#).

1.2 Loading the Software

1. Click the **Renesas DAQ on a Stick Software** link to load the executable.
2. Follow the on-screen instructions to complete the software installation. The installation program places the user interface software in the C:\Program Files\R12UZ0049_DAQ_V250 directory.
3. To create a shortcut on your desktop, check the **Create A Desktop Icon** box during the software installation.
4. Launch the application by checking the **Launch R12UZ0049_DAQ_V250** box, then click **Finish**.

1.3 Running the Evaluation Software

1. After installing the software, connect the Honeywell pressure sensor board to the DAQ on a Stick as shown in [Figure 1 on page 2](#). This provides 5V and ground to power the sensor.
2. Plug the DAQ on a Stick into a USB port on the computer
3. Click the Renesas DAQ shortcut (created in [“Installing the Software and USB Drivers”](#)) on the desktop. [Figure 3](#) shows the desktop icon. The green LED on the DAQ on a Stick board turns on.

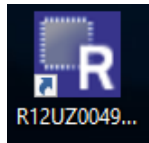

Figure 3. Desktop Icon

When the software starts, the DAQ Startup screen shown in [Figure 5 on page 5](#) appears. With the DAQ on a Stick connected, the USB Status indicator displays “Connected 0x2032”. The assigned HID PID code for this application is 0x2032. This code is verification the software is communicating with the board.

If the DAQ on a Stick is not connected, or a problem exists with the demo, the message reads “HID Device Not Found”. If this occurs, click the **Test USB Connection** button to enable the connection. If the connection is still not enabled, disconnect and reconnect the device or restart the software.

2. Startup Screen

From the DAQ Startup Screen (Figure 5), click **Instantaneous Voltage** to get a single voltage reading, select the sensor input to measure, and adjust the amplifier gain, or click **Start** to go to the Measurement Display screen shown in Figure 6 on page 6.

2.1 Measuring Pressure with the Honeywell Sensor Board

The DAQ on a Stick reference design can measure both external sensors and an internal bridge sensor. Figure 4 shows the available inputs and outputs. The input pins are labeled “s”. The “s” applies to resistive changes in a bridge configuration and are not used for the Honeywell demonstration. See Application Note R12UZ0045 for bridge measurements using these inputs.

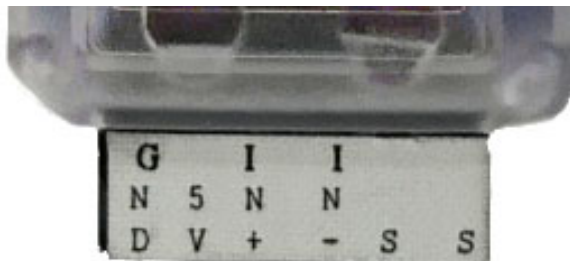

Figure 4. Sensor Connector

The outputs labeled GND and 5V power the Honeywell pressure sensor board. The inputs IN+ and IN- measure the pressure applied. Select which sensor is measured by clicking the appropriate radio button (**Sensor Supplied with the Demo** or **Customer Supplied**) at the bottom of the GUI Startup Screen. The **Customer Supplied** is the default value in the software with a gain of 110V/V. In this configuration, the ISL43840 mux configured as a differential mux connects the IN+ and IN- inputs to the differential amplifier constructed with two ISL28134 zero drift amplifiers. You can change the amplifiers’ gain for the best measurement. For the syringe application, the gain setting of 110 is ideal.

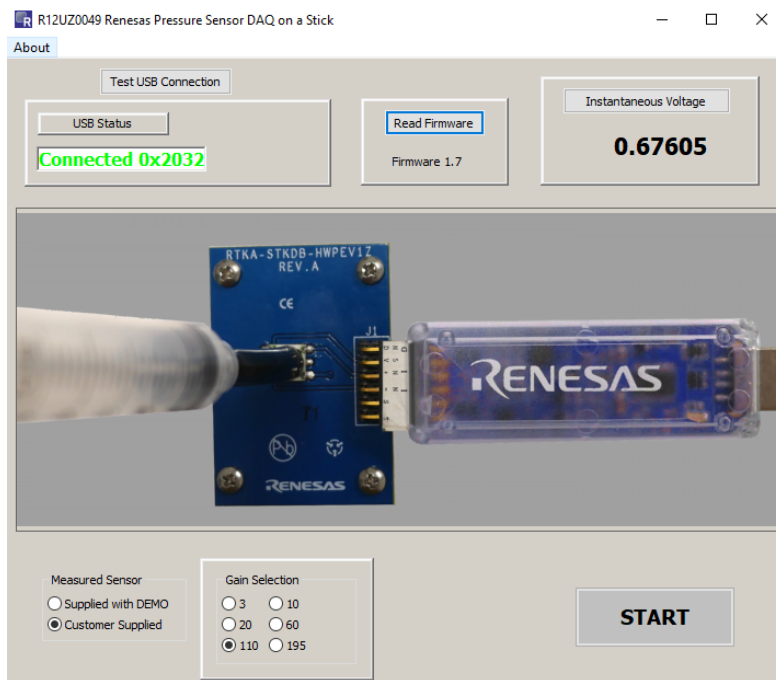

Figure 5. GUI Startup Screen

3. Measurement Display Screen

Click **Start** on the Startup Screen to go to the Measurement Display Screen (Figure 6). From this screen you can do the following:

- Start and stop data collection.
- Adjust the scaling of the X and Y axes (Automatic or Manual).
- Remove any offsets with the **Calibrate** button. The **Calibrate** button zeros out the voltage reading when the Honeywell sensor is not under pressure, which helps give an accurate reading from time zero.

Additional functionality is provided in the menu items at the top of the Measurement Screen in the menu bar.

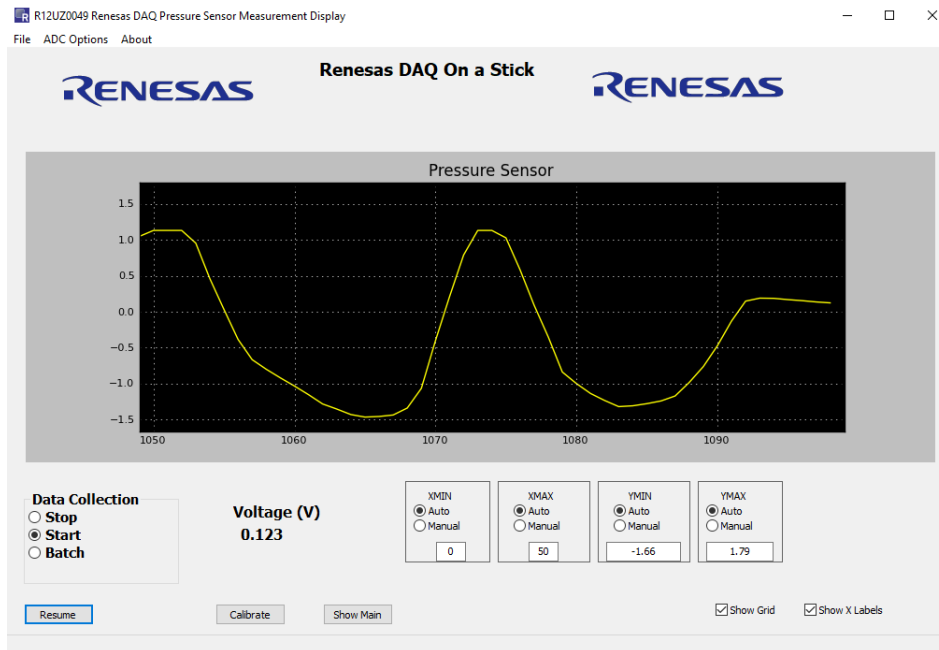
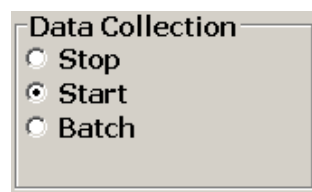

Figure 6. GUI Measurement Screen

3.1 Data Collection Radio Box

The Data Collection radio box is one of the most actively used controls.



- **Start** begins data collection and graphing in real time of the measured ADC values.
- **Stop** halts data collection.
- **Batch** enters a “Capture then Display” mode where data is collected for several measurements and displayed all at once. Use Batch mode to collect periodic waveforms where the overhead of real-time graphing would result in missed measurements. See [“Measuring Batch Mode Throughput” on page 10](#).

3.2 Graphing X and Y Axis Control

The X and Y axis control windows enable control of the graph area horizontal (XMIN, XMAX) and vertical (YMIN, YMAX) axes.

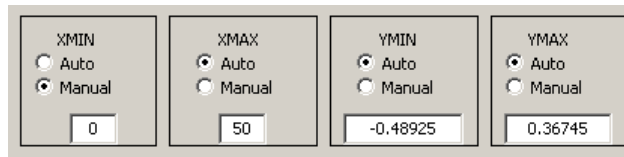

With **Auto** selected, the last 50 measurements are displayed as data collection runs. This produces a horizontal scrolling of the data.

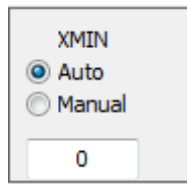

To see the history of the sensor reading from the beginning, pin the X axis to 0 by clicking **Manual** in the XMIN box and entering 0 in the selection window.

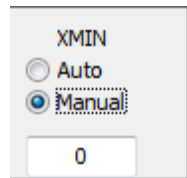

Typing in another value in the selection window jumps to that location.

The Y axis is automatically adjusted as data is collected. However, when graphing “flat line” waveforms, you can select **Manual** while data collection is running and zoom the Y axis in to see further detail.

During initialization, the controls are set to **Auto**. When started, you can select **Manual** and change the Y axis.

Note: The axis controls affect the graph display area only. During data export, all data collected, regardless of graph scaling, is sent to the .csv file.

3.3 Grid and X Labels Check Boxes

The **Show Grid** and **Show X Labels** boxes are graphing display options. Disable (deselect) **Show Grid** or **Show X Labels** to speed up real-time graphing display. These options can be enabled and disabled at any time.



3.4 Show Main Button

The **Show Main** button re-displays the Startup screen.



If clicked more than once, the Startup form can be hidden behind the Measurement Form. You can move the forms so both can be viewed simultaneously.

3.5 Measurement Display Menu Options

The Measurement Display has a Menu bar at the top.



- **File** exports collected data to a .csv file and captures a picture of the graph display
- **ADC Options** sets the ADC sample rate and the ADC channel and enables/disables “flushing” during real-time data collection (flushing is always disabled when using Batch mode data collection). See [“Real Time Graph Options and Flushing” on page 10](#)
- **About** shows the schematic of the DAQ on a Stick and offers another way for you to read the firmware version

These items are discussed in more detail in the following sections.

3.5.1 File

In the **File** menu, click **Save Chart** to save an image of the Graph or click **Export Data** to export the collected data to a .csv file to import it into other applications.

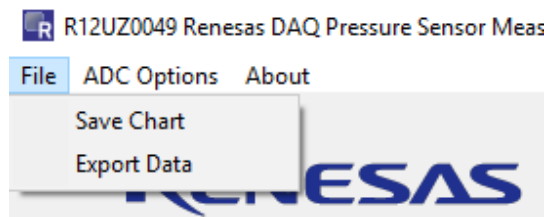

3.5.2 About

The **About** menu provides information about the firmware version, a block diagram of the circuit, a schematic of the DAQ on a Stick circuit, and a schematic of the Daughter Board schematic.

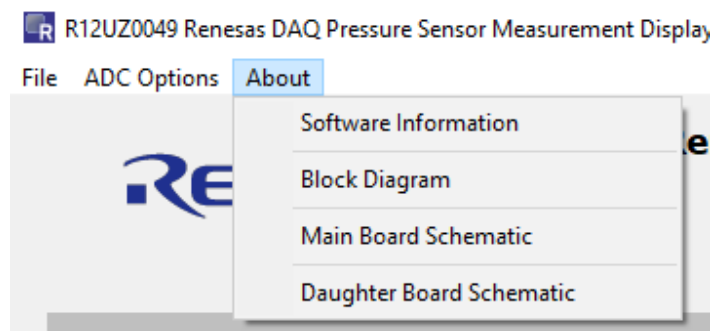

3.5.3 ADC Options

The **ADC Options** menu has three sections that are made up of radio box selections.

- **AD Word Rate** programs the ISL26102 ADC samples per second. See the ISL26102 datasheet for more information about sampling rates
- **AD Channel Selection** selection determines which ISL26102 channel is measured: Channel 1 is the ISL28134 output that forms the differential output signal. Channel 2 has both inputs grounded for testing
- **Run Option** enables Flush and No Flush buffer operation. See [“Real Time Graph Options and Flushing” on page 10](#) for more information

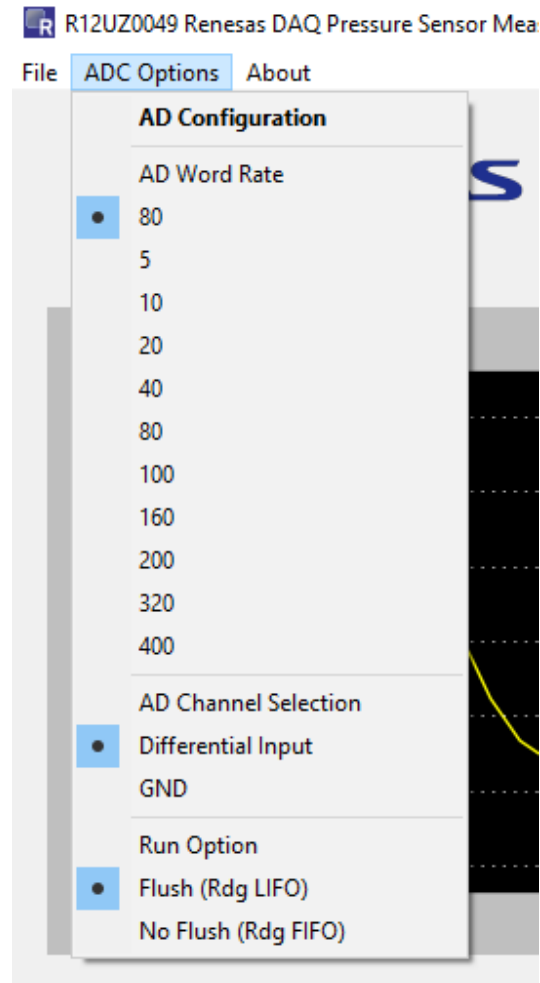

4. Measuring Throughput

The Sensor Measurement application speed can be affected by the operating system, speed/type of processor, and number of other windows or applications running concurrently.

Renesas demonstrations have the following requirements:

- The firmware must be able to collect all measurements and transmit them over the USB
- The USB methodology (speed and type of pipe/endpoints) should be able to accommodate the transmission and reception of all measurements
- The GUI needs to collect and display the information while other Windows applications may be open

4.1 Using the Export Data to Analyze the Measurement Speed of an Installation

Perform empirical speed measurements with the Export function. See the “Firmware Count” column in [Figure 7 on page 10](#).

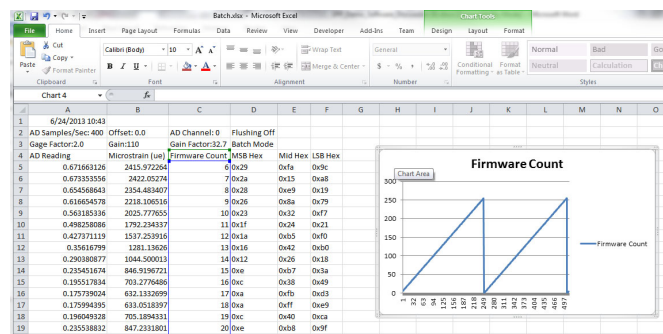

Figure 7. Sawtooth when Plotting "Firmware Count"

If all readings are being collected, the value in the column counts from 0 to 255, rolls over to zero, and starts over. If you plot this column, the graph should yield a perfect sawtooth waveform when all measurements are being collected.

4.2 Measuring Batch Mode Throughput

Developer tests on various installations indicate all measurements can be collected in “Batch” mode at up to 400Sps (samples per second). However, this speed can vary between installations. [Figure 7](#) shows that the “Exported” data should yield a sawtooth waveform in the “Firmware Count” column.

4.3 Real Time Graph Options and Flushing

With real-time graphing, it is possible to record all measurements if the sample rate is slow enough to accommodate Graphing and USB throughput overhead. **Flush** and **No Flush** selections are available in the **AD Options** menu.

[Figure 8 on page 11](#) is a screen shot of a low frequency periodic ramp “AD Reading” and “Firmware Count.” The waveform can reproduce accurately even with real-time graphing if flushing is disabled.

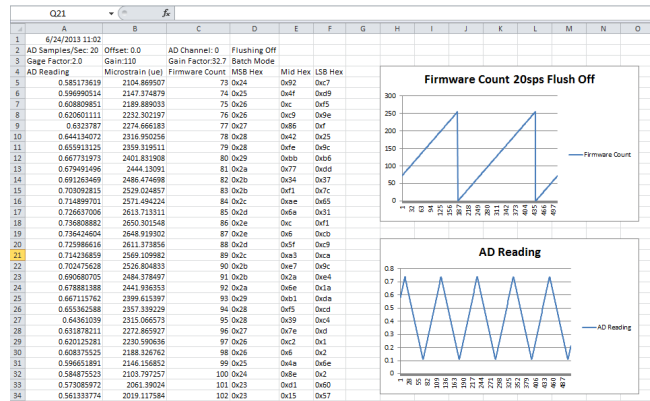

Figure 8. Low Frequency Real Time Graph with Flushing Off

However, if flushing is enabled, measurements are skipped arbitrarily. Figure 9 shows the same waveform and sample rate as Figure 8, but with flushing enabled.

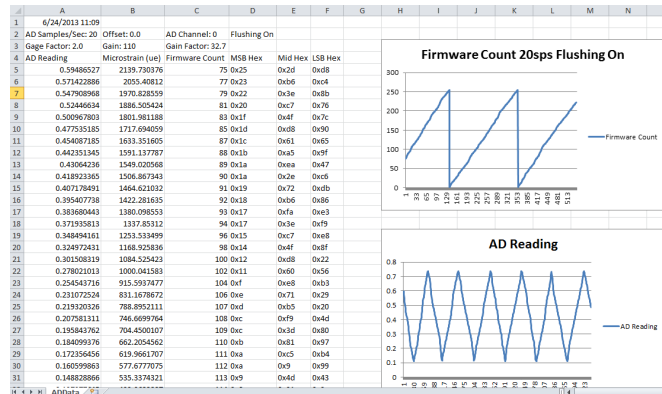

Figure 9. Low Frequency Real Time Graph with Flushing On

As Figure 9 shows, the “Firmware Count” has missing values and the collected waveform is more jagged with flushing on.

4.4 Typical Throughput at 80Sps

With “Flush On” at the default 80Sps, about every third measurement is collected. This yields a smoother sawtooth; however, again about every third measurement is actually collected.

Figure 10 demonstrates measurement at 80Sps, with real-time graphing and flushing on. About every third measurement is collected.

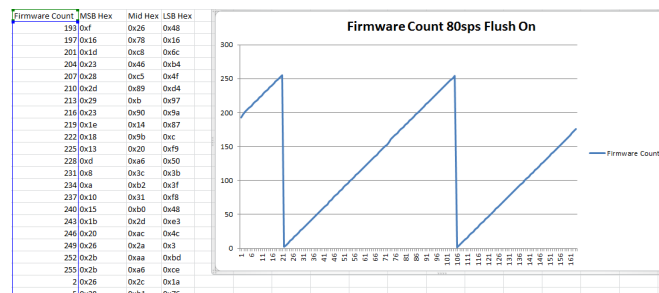

Figure 10. Real-Time Graph 80Sps Flushing On

“Flush Off” at 80Sps yields more continuous samples; however, large gaps occur when the USB buffer fills up and flushing is arbitrated by the USB driver.

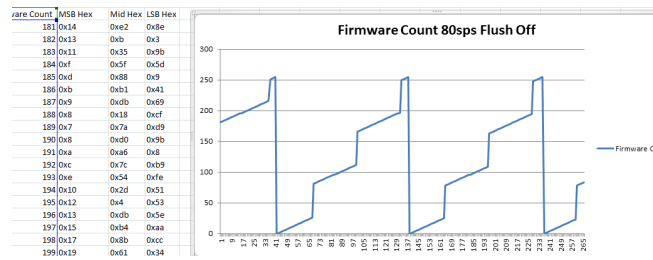

Figure 11. Real Time Graph 80Sps Flushing Off

In summary, when running at 80Sps with real-time graphing and flushing off, more continuous measurements are displayed, with larger gaps when USB buffers overflow. When running at 80Sps, with real-time graphing and flushing off, more continuous measurements are displayed with larger gaps when USB buffers overflow.

4.5 Throughput Summary

- You can observe measurement throughput of an installation by examining the “Firmware Count” column in the Exported Data.
- Batch mode is capable of collecting continuous measurements at up to 400Sps. However, this value may be lower based on specific installation factors.

The **Flush/No Flush** selection can force real-time updates. **Flush** works better at higher sample rates and **No Flush** works better with lower sample rates. Again, results may vary by installation.

5. Design Considerations

5.1 ISL28134

The ISL28134 is an ideal choice for the input amplifier for a pressure gauge design. The ISL28134 uses auto-correction circuitry to provide ultra low offset voltage (2.5 μ V) and low offset temperature drift (15nV/ $^{\circ}$ C). The very low 1/f noise corner <0.1Hz and low input noise voltage of the amplifier (8nV/ $\sqrt{\text{Hz}}$ at 100Hz) makes it ideal for low frequency precision applications requiring very high gain and low noise. Other key features of the ISL28134 are the wide gain bandwidth and rail-to-rail input/output swing.

5.2 ISL26102 24-Bit ADC

The ISL26102 is a complete analog front-end with dual differential multiplexed inputs for high resolution measurements. The ISL26102 features a third order modulator providing up to 21.4-bit noise-free performance (10Sps). The 24-bit delta-sigma analog-to-digital converter includes a very low-noise amplifier with programmable gain. Although this application demo uses an input buffer amplifier (ISL28134), the high input impedance of the ISL26102 allows direct connection of sensors such as load cell bridges to ensure the specified measurement accuracy without a buffer amplifier.

To initiate a correct power-up reset, diode D₁, resistor R₃, and capacitor C₈ implement a simple RC delay to ensure the $\overline{\text{PDWN}}$ transitions from low-to-high after both power supplies settle to specified levels.

5.3 ISL21010 (3.3V) Voltage Reference

The ISL21010CFH333 is a precision 3.3V, low dropout micropower band-gap voltage reference, which provides a $\pm 0.2\%$ accurate reference. The ISL21010 provides up to 25mA output current sourcing with low 150mV dropout voltage. The low supply current and low dropout voltage combined with high accuracy make the ISL21010 ideal for precision low powered applications.

5.4 ISL21010 (4.096V) Voltage Reference

The ISL21010CFH341 is a precision 4.096V, low dropout micropower band-gap voltage reference, which provides a $\pm 0.2\%$ accurate reference. The ISL21010 provides up to 25mA output current sourcing with low 150mV dropout voltage. The low supply current and low dropout voltage combined with high accuracy make the ISL21010 ideal for precision low powered applications.

5.5 ISL22316 DCP

The ISL22316 is a low noise, low power I²C bus, 128 tap DCP. The DCP can be used as a three-terminal potentiometer or as a two-terminal variable resistor in a wide variety of applications including control, parameter adjustments, and signal processing.

5.6 ISL43840 Low-Voltage, Dual 4-to-1 Multiplexer

The ISL43840 is a precision, bidirectional, analog switch configured as a dual 4-channel multiplexer/demultiplexer. In this design, the mux is configured as a differential mux. The mux can operate from a single +2V to +12V supply or from a $\pm 2\text{V}$ to $\pm 6\text{V}$ supply. The ISL43840 has low charge injection with 1pC (Max) at VS = $\pm 5\text{V}$.

5.7 Bill of Materials, DAQ on a Stick and Pressure Sensor

Part Number	Ref Des	Qty	Value	Tol.	Voltage	Pwr	Package Type	JEDEC Type	Mfr	Description
C0805C475K4RAC7800	C1	1	4.7µF	10%	16V		805	CAP_0805	Kemet	Ceramic Cap
C0402C102K5RAC7867	C7, C12, C13, C20	4	0.01µF	10%	16V		402	CAP_0402	Kemet	Multilayer Cap
C0402C104K4RAC7867	C5, C8, C9, C11, C14, C25, C27	7	0.1µF	10%	16V		402	CAP_0402	Kemet	Multilayer Cap
C0603C103K5RAC7867	C21, C22	2	0.01µF	10%	25V		603	CAP_0603	Kemet	Multilayer Cap
CBR04C180J5GACTU	C23, C24	2	10pF	5%	25V		402	CAP_0402RF	Kemet	C Series High-Q Chip Cap
C0603C105K4RAC7867	C2, C3, C10, C26	4	1µF	20%	16V		603	CAP_0603	Kemet	Ceramic Cap
Generic	C6	1	0.33µF	10%	25V		603	CAP_0603	Various	Multilayer Cap
C0603-OPEN	C17, C18	2	OPEN	5%	OPEN		603	CAP_0603	Kemet	Multilayer Cap
C0805C225K4RAC7800	C15	1	2.2µF	10%	16V		805	CAP_0805	Kemet	Multilayer Cap
C1206C106K4RAC7800	C4	1	10µF	10%	16V		1206	CAP_1206	Kemet	Multilayer Cap
597-3311-407	D1	1					SMD	DIA_LED1206	Dialight	Surface Mount Green LED
BAT54	D2	1					SINGLE	SOT23	Diodes	30V Schottky Diode
MMSD4148T1	D3 - D6	4					SOD123	SOD123	On-Semi	Switching Diode
48037-1000	J1	1					MOLEX1	CON_USB_MOLEX_480371000	Molex	Right Angle USB A-Type Receptacle
PPPC062LJBN-RC	J2	1					DIP	CONN12	Sullins	12 Pin Header 2.54mmx2.54mm (.100) Connector RA
251206102Y1	L1	1	1µH				SMD	SM1206	Fair-Rite	Ferrite Bead
MCR01MZSJ000	R7, R11, R27	3	0	0%		1/16W	402	RES_0402	Rohm	Thick Film Chip Resistor
MCR01MZSF1000	R2, R3	2	100	1%		1/16W	402	RES_0402	Rohm	Thick Film Chip Resistor
MCR01MZSF1001	R8	1	1k	1%		1/16W	402	RES_0402	Rohm	Thick Film Chip Resistor
MCR01MZSF1002	R1, R4, R15, R16	4	10k	1%		1/16W	402	RES_0402	Rohm	Thick Film Chip Resistor
MCR01MZSF2200	R28	1	220	1%		1/16W	402	RES_0402	Rohm	Thick Film Chip Resistor
MCR01MZSF4991	R5, R6, R31	3	4.99k	1%		1/16W	402	RES_0402	Rohm	Thick Film Chip Resistor
MCR01MZSF4992	R12, R13	2	49.9k	1%		1/16W	402	RES_0402	Rohm	Thick Film Chip Resistor
MCR01MZSF49R9	R9, R10	2	49.9	1%		1/16W	402	RES_0402	Rohm	Thick Film Chip Resistor
Generic	R14, R29	2	DNP	1%		DNP	402	RES_0402	Various	Thick Film Chip Resistor (Do Not Populate)
Generic	R20, R23, R26	3	1	0.1 %		1/10W	805	RES_0805	Various	Thick Film Chip Resistor

Part Number	Ref Des	Qty	Value	Tol.	Voltage	Pwr	Package Type	JEDEC Type	Mfr	Description
Generic	R30	1	DNP	0.1 %		DNP	503	RES_0603	Various	Thick Film Chip Resistor (Do Not Populate)
Generic	R19, R22, R25	3	100	0.1 %		1/10W	805	RES_0805	Various	Thick Film Chip Resistor
Generic	R18, R21, R24	3	249	0.1 %		1/10W	805	RES_0805	Various	Thick Film Chip Resistor
ISL26102AVZ	U1	1					TSSOP	TSSOP24_173_256	Renesas	24 Pin 173 Mil TSSOP Package
ISL21010CFH341Z	U2	1					SOT	SOT23-3	Renesas	3 PIN SOT23-3 PACKAGE
ISL28134FHZ	U3, U4	2					SMD	SOT23-5	Renesas	5 Pin SOT23 Package
ISL43840IRZ	U5	1					QFN	QFN20_157X157_197_EP	Renesas	20 LEAD QUAD FLAT PACKAGE (Pb-FREE)
ISL22316WFRT	U6	1					DFN3X3B	TDFN10_118X118_197_EPB	Renesas	10 Lead 3 X 3 0.5 Pitch Thin Dual Flat Package with E-Pad
R5F10JBCANA	U7	1					QFN-S	QFN32_197X197_197_EPA	Renesas	32 Lead Quad Flat Package (Pb-Free)
IP422OCZ6	U8	1					SOT457	SOT457	NXP	Dual USB 2.0 Integrated ESD Protection
ISL54054IRUZ	U9	1					1_2X1A	UTDFN6_47X39_157_A	Renesas	6 PIN UTDFN-1.2X1A 0.4 Pitch Package
ISL21010CFH333Z	U10	1					SOT	SOT23-3	Renesas	3 PIN SOT23-3 PACKAGE
MCR03EZPFX3001	R17	1	3k	1%		1/10W	603	RES_0603	Rohm	Metal Film Chip Resistor
PAD_50	P1, P2	2					THOLE	PAD-50	Generic	0.050 Pad with 0.031 Plated Thru Hole
Q22FA23V0000114	Y1	1					SM	XTAL_NX5032GA	Epson	12.000MHz SM Crystal
NBPLLNN030PGUNV	J1-DB	1					LN	Single axial barb less port	Honeywell	NBP Series- Uncompensated/Unamplified 0 _{psi} to 30 _{psi} basic board mount pressure sensor
PPPC062LJBN-RC	Pressure sensor board connector	1					DIP	CONN12	Sullins	12 Pin Header 2.54mm x 2.54mm (0.100) Connector RA
MTSW-106-22-G-215-RA	Adapter to Connect the Two Boards	1					DIP	CONN12	Samtec	12 Pin Header 2.54mm x 2.54mm (0.100) Connector
NY-PMS-440-0050-PH		4							B&F Fastener Supply	Nylon Screw
1902C		4							Keystone Electronics	Hex Nylon Stand-off
Insul Grip HS-101-1 Polyo		1							Insul/ lab	1/4 inch Shrink Tubing
Syringe		1								

5.8 RTKA-BDGSTKEV2Z Evaluation Board Layout

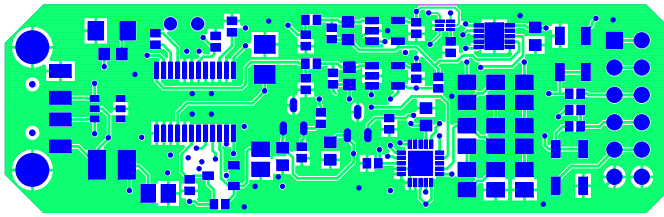

Figure 12. Top Layer

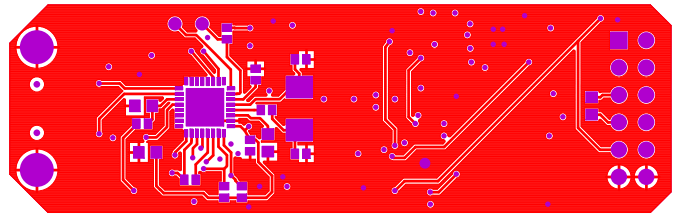

Figure 13. Bottom Layer

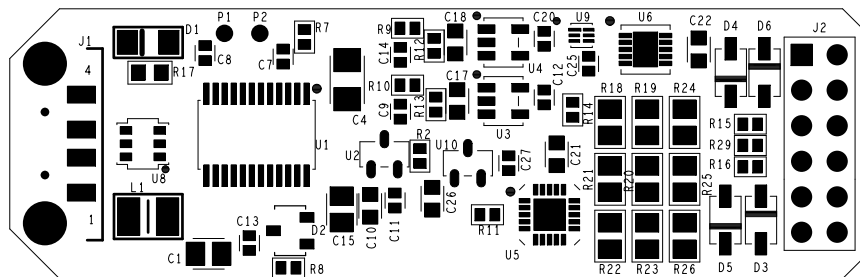

Figure 14. Top Assembly Drawing

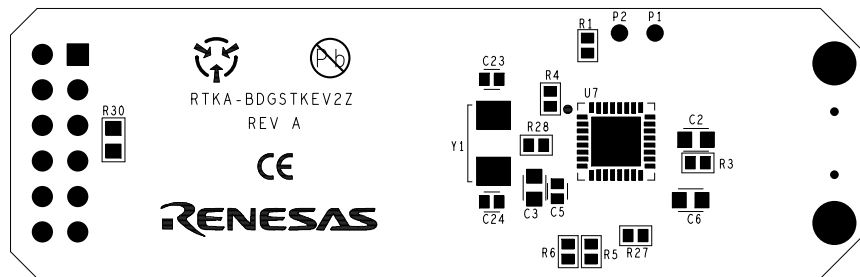

Figure 15. Bottom Assembly Drawing

5.9 RTKA-STKDB-HWPEV1Z Evaluation Board Layout

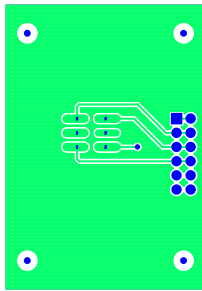

Figure 16. Top Layer

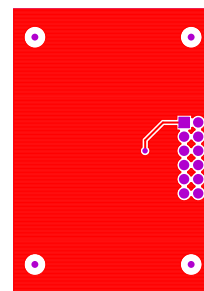

Figure 17. Bottom Layer

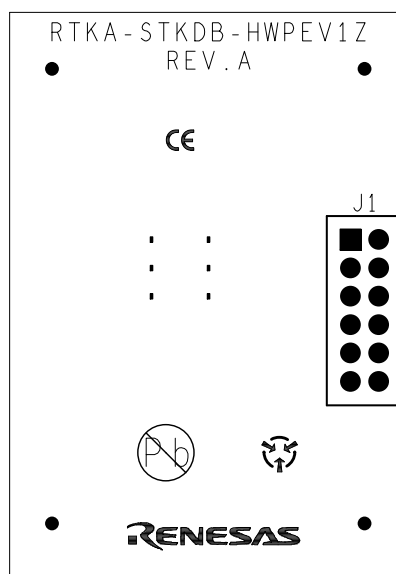
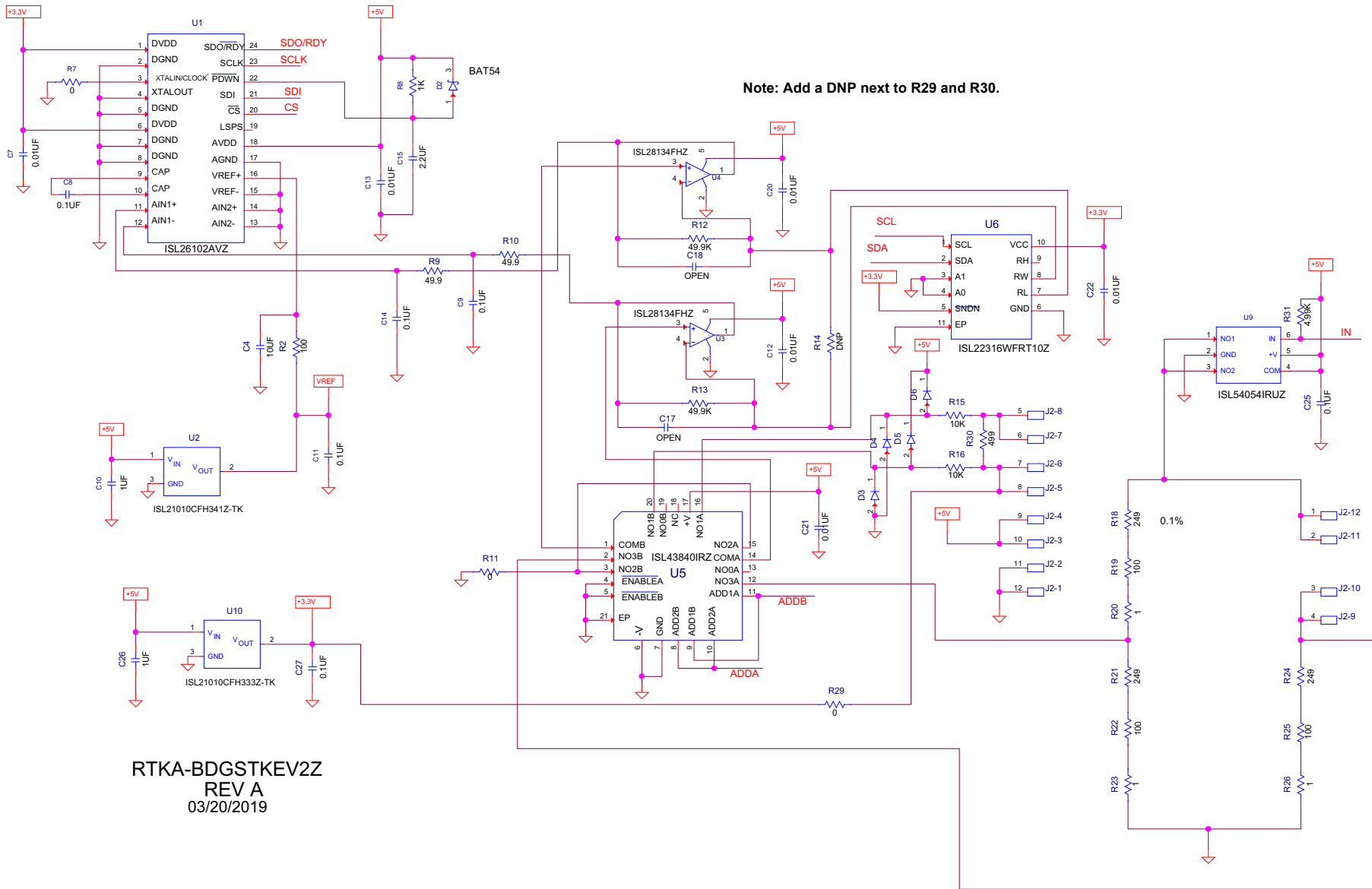

Figure 18. Assembly Drawing

5.10 RTKA-BDGSTKEV2Z Schematic



RTKA-BDGSTKEV2Z
REV A
03/20/2019

Figure 19. RTKA-BDGSTKEV2Z Strain Gauge Schematic

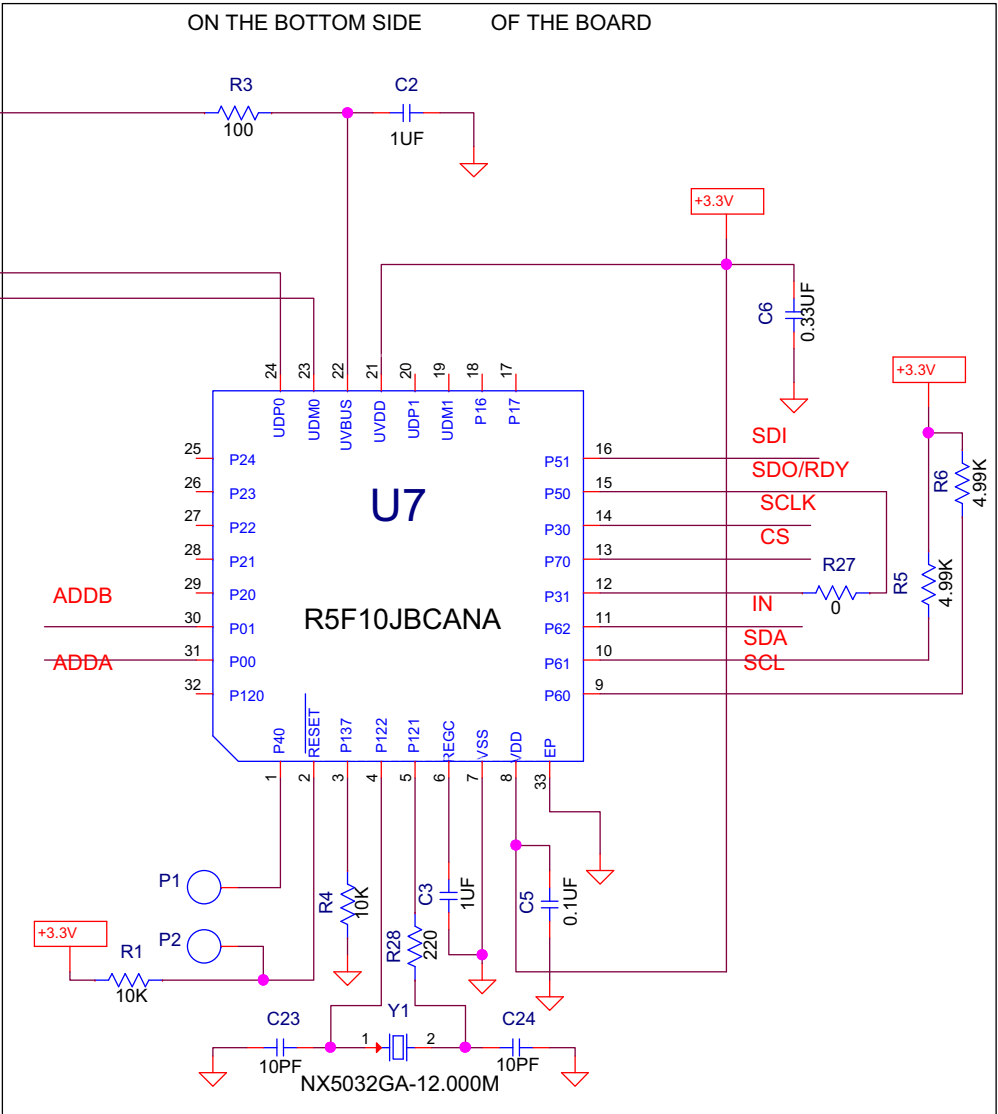

Figure 20. RTKA-BDGSTKEV2Z MCU Schematic

5.11 RTKA-STKDB-HWPEV1Z Schematic

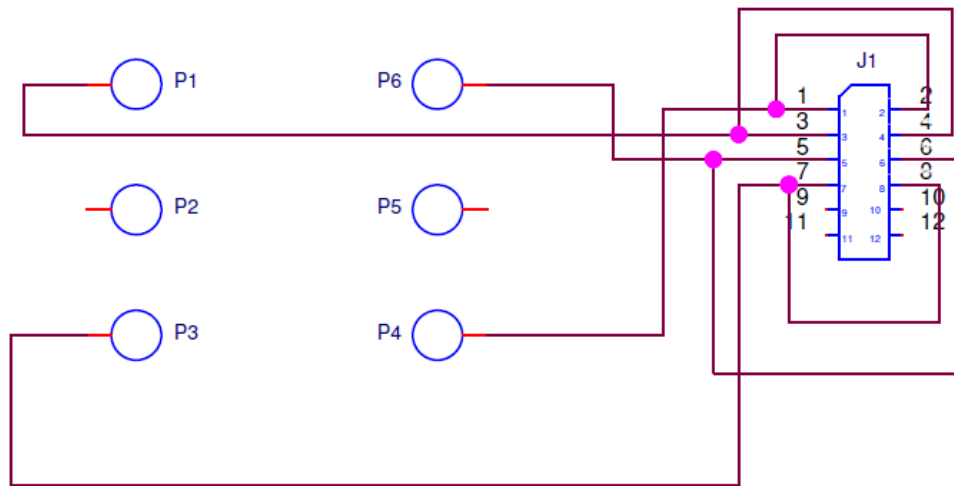

Figure 21. Pressure Sensor Daughter Board Schematic

6. Revision History

Rev.	Date	Description
2.00	Jul.9.19	Updated Bill of Materials
1.01	Jun.5.19	Updated ISL21010 information.
1.00	Apr.9.19	Initial release.

Notice

1. Descriptions of circuits, software and other related information in this document are provided only to illustrate the operation of semiconductor products and application examples. You are fully responsible for the incorporation or any other use of the circuits, software, and information in the design of your product or system. Renesas Electronics disclaims any and all liability for any losses and damages incurred by you or third parties arising from the use of these circuits, software, or information.
2. Renesas Electronics hereby expressly disclaims any warranties against and liability for infringement or any other claims involving patents, copyrights, or other intellectual property rights of third parties, by or arising from the use of Renesas Electronics products or technical information described in this document, including but not limited to, the product data, drawings, charts, programs, algorithms, and application examples.
3. No license, express, implied or otherwise, is granted hereby under any patents, copyrights or other intellectual property rights of Renesas Electronics or others.
4. You shall not alter, modify, copy, or reverse engineer any Renesas Electronics product, whether in whole or in part. Renesas Electronics disclaims any and all liability for any losses or damages incurred by you or third parties arising from such alteration, modification, copying or reverse engineering.
5. Renesas Electronics products are classified according to the following two quality grades: "Standard" and "High Quality". The intended applications for each Renesas Electronics product depends on the product's quality grade, as indicated below.
 - "Standard": Computers; office equipment; communications equipment; test and measurement equipment; audio and visual equipment; home electronic appliances; machine tools; personal electronic equipment; industrial robots; etc.
 - "High Quality": Transportation equipment (automobiles, trains, ships, etc.); traffic control (traffic lights); large-scale communication equipment; key financial terminal systems; safety control equipment; etc.Unless expressly designated as a high reliability product or a product for harsh environments in a Renesas Electronics data sheet or other Renesas Electronics document, Renesas Electronics products are not intended or authorized for use in products or systems that may pose a direct threat to human life or bodily injury (artificial life support devices or systems; surgical implantations; etc.), or may cause serious property damage (space system; undersea repeaters; nuclear power control systems; aircraft control systems; key plant systems; military equipment; etc.). Renesas Electronics disclaims any and all liability for any damages or losses incurred by you or any third parties arising from the use of any Renesas Electronics product that is inconsistent with any Renesas Electronics data sheet, user's manual or other Renesas Electronics document.
6. When using Renesas Electronics products, refer to the latest product information (data sheets, user's manuals, application notes, "General Notes for Handling and Using Semiconductor Devices" in the reliability handbook, etc.), and ensure that usage conditions are within the ranges specified by Renesas Electronics with respect to maximum ratings, operating power supply voltage range, heat dissipation characteristics, installation, etc. Renesas Electronics disclaims any and all liability for any malfunctions, failure or accident arising out of the use of Renesas Electronics products outside of such specified ranges.
7. Although Renesas Electronics endeavors to improve the quality and reliability of Renesas Electronics products, semiconductor products have specific characteristics, such as the occurrence of failure at a certain rate and malfunctions under certain use conditions. Unless designated as a high reliability product or a product for harsh environments in a Renesas Electronics data sheet or other Renesas Electronics document, Renesas Electronics products are not subject to radiation resistance design. You are responsible for implementing safety measures to guard against the possibility of bodily injury, injury or damage caused by fire, and/or danger to the public in the event of a failure or malfunction of Renesas Electronics products, such as safety design for hardware and software, including but not limited to redundancy, fire control and malfunction prevention, appropriate treatment for aging degradation or any other appropriate measures. Because the evaluation of microcomputer software alone is very difficult and impractical, you are responsible for evaluating the safety of the final products or systems manufactured by you.
8. Please contact a Renesas Electronics sales office for details as to environmental matters such as the environmental compatibility of each Renesas Electronics product. You are responsible for carefully and sufficiently investigating applicable laws and regulations that regulate the inclusion or use of controlled substances, including without limitation, the EU RoHS Directive, and using Renesas Electronics products in compliance with all these applicable laws and regulations. Renesas Electronics disclaims any and all liability for damages or losses occurring as a result of your noncompliance with applicable laws and regulations.
9. Renesas Electronics products and technologies shall not be used for or incorporated into any products or systems whose manufacture, use, or sale is prohibited under any applicable domestic or foreign laws or regulations. You shall comply with any applicable export control laws and regulations promulgated and administered by the governments of any countries asserting jurisdiction over the parties or transactions.
10. It is the responsibility of the buyer or distributor of Renesas Electronics products, or any other party who distributes, disposes of, or otherwise sells or transfers the product to a third party, to notify such third party in advance of the contents and conditions set forth in this document.
11. This document shall not be reprinted, reproduced or duplicated in any form, in whole or in part, without prior written consent of Renesas Electronics.
12. Please contact a Renesas Electronics sales office if you have any questions regarding the information contained in this document or Renesas Electronics products.

(Note1) "Renesas Electronics" as used in this document means Renesas Electronics Corporation and also includes its directly or indirectly controlled subsidiaries.

(Note2) "Renesas Electronics product(s)" means any product developed or manufactured by or for Renesas Electronics.

(Rev.4.0-1 November 2017)

Corporate Headquarters

TOYOSU FORESIA, 3-2-24 Toyosu,
Koto-ku, Tokyo 135-0061, Japan
www.renesas.com

Contact Information

For further information on a product, technology, the most up-to-date version of a document, or your nearest sales office, please visit:
www.renesas.com/contact/

Trademarks

Renesas and the Renesas logo are trademarks of Renesas Electronics Corporation. All trademarks and registered trademarks are the property of their respective owners.

RTKA-BDGSTKDBEVKIT1Z