

RI78V4

Real-Time Operating System

User's Manual: Analysis

Target Tool

RI78V4

All information contained in these materials, including products and product specifications, represents information on the product at the time of publication and is subject to change by Renesas Electronics Corp. without notice. Please review the latest information published by Renesas Electronics Corp. through various means, including the Renesas Electronics Corp. website (<http://www.renesas.com>).

Notice

1. All information included in this document is current as of the date this document is issued. Such information, however, is subject to change without any prior notice. Before purchasing or using any Renesas Electronics products listed herein, please confirm the latest product information with a Renesas Electronics sales office. Also, please pay regular and careful attention to additional and different information to be disclosed by Renesas Electronics such as that disclosed through our website.
2. Renesas Electronics does not assume any liability for infringement of patents, copyrights, or other intellectual property rights of third parties by or arising from the use of Renesas Electronics products or technical information described in this document. No license, express, implied or otherwise, is granted hereby under any patents, copyrights or other intellectual property rights of Renesas Electronics or others.
3. You should not alter, modify, copy, or otherwise misappropriate any Renesas Electronics product, whether in whole or in part.
4. Descriptions of circuits, software and other related information in this document are provided only to illustrate the operation of semiconductor products and application examples. You are fully responsible for the incorporation of these circuits, software, and information in the design of your equipment. Renesas Electronics assumes no responsibility for any losses incurred by you or third parties arising from the use of these circuits, software, or information.
5. When exporting the products or technology described in this document, you should comply with the applicable export control laws and regulations and follow the procedures required by such laws and regulations. You should not use Renesas Electronics products or the technology described in this document for any purpose relating to military applications or use by the military, including but not limited to the development of weapons of mass destruction. Renesas Electronics products and technology may not be used for or incorporated into any products or systems whose manufacture, use, or sale is prohibited under any applicable domestic or foreign laws or regulations.
6. Renesas Electronics has used reasonable care in preparing the information included in this document, but Renesas Electronics does not warrant that such information is error free. Renesas Electronics assumes no liability whatsoever for any damages incurred by you resulting from errors in or omissions from the information included herein.
7. Renesas Electronics products are classified according to the following three quality grades: “Standard”, “High Quality”, and “Specific”. The recommended applications for each Renesas Electronics product depends on the product’s quality grade, as indicated below. You must check the quality grade of each Renesas Electronics product before using it in a particular application. You may not use any Renesas Electronics product for any application categorized as “Specific” without the prior written consent of Renesas Electronics. Further, you may not use any Renesas Electronics product for any application for which it is not intended without the prior written consent of Renesas Electronics. Renesas Electronics shall not be in any way liable for any damages or losses incurred by you or third parties arising from the use of any Renesas Electronics product for an application categorized as “Specific” or for which the product is not intended where you have failed to obtain the prior written consent of Renesas Electronics. The quality grade of each Renesas Electronics product is “Standard” unless otherwise expressly specified in a Renesas Electronics data sheets or data books, etc.
 - “Standard”: Computers; office equipment; communications equipment; test and measurement equipment; audio and visual equipment; home electronic appliances; machine tools; personal electronic equipment; and industrial robots.
 - “High Quality”: Transportation equipment (automobiles, trains, ships, etc.); traffic control systems; anti-disaster systems; anti-crime systems; safety equipment; and medical equipment not specifically designed for life support.
 - “Specific”: Aircraft; aerospace equipment; submersible repeaters; nuclear reactor control systems; medical equipment or systems for life support (e.g. artificial life support devices or systems), surgical implantations, or healthcare intervention (e.g. excision, etc.), and any other applications or purposes that pose a direct threat to human life.
8. You should use the Renesas Electronics products described in this document within the range specified by Renesas Electronics, especially with respect to the maximum rating, operating supply voltage range, movement power voltage range, heat radiation characteristics, installation and other product characteristics. Renesas Electronics shall have no liability for malfunctions or damages arising out of the use of Renesas Electronics products beyond such specified ranges.
9. Although Renesas Electronics endeavors to improve the quality and reliability of its products, semiconductor products have specific characteristics such as the occurrence of failure at a certain rate and malfunctions under certain use conditions. Further, Renesas Electronics products are not subject to radiation resistance design. Please be sure to implement safety measures to guard them against the possibility of physical injury, and injury or damage caused by fire in the event of the failure of a Renesas Electronics product, such as safety design for hardware and software including but not limited to redundancy, fire control and malfunction prevention, appropriate treatment for aging degradation or any other appropriate measures. Because the evaluation of microcomputer software alone is very difficult, please evaluate the safety of the final products or system manufactured by you.
10. Please contact a Renesas Electronics sales office for details as to environmental matters such as the environmental compatibility of each Renesas Electronics product. Please use Renesas Electronics products in compliance with all applicable laws and regulations that regulate the inclusion or use of controlled substances, including without limitation, the EU RoHS Directive. Renesas Electronics assumes no liability for damages or losses occurring as a result of your noncompliance with applicable laws and regulations.
11. This document may not be reproduced or duplicated, in any form, in whole or in part, without prior written consent of Renesas Electronics.
12. Please contact a Renesas Electronics sales office if you have any questions regarding the information contained in this document or Renesas Electronics products, or if you have any other inquiries.

(Note 1) “Renesas Electronics” as used in this document means Renesas Electronics Corporation and also includes its majority-owned subsidiaries.

(Note 2) “Renesas Electronics product(s)” means any product developed or manufactured by or for Renesas Electronics.

How to Use This Manual

Readers This manual is intended for users who design and develop application systems using 78K0R microcontroller or RL78 family products.

Purpose This manual is intended for users to understand the functions of real-time OS " RI78V4" manufactured by Renesas Electronics, described the organization listed below.

Organization This manual consists of the following major sections.

CHAPTER 1 GENERAL
CHAPTER 2 FUNCTIONS
APPENDIX A WINDOW REFERENCE
APPENDIX B MESSAGES
APPENDIX C INDEX

How to read this manual It is assumed that the readers of this manual have general knowledge in the fields of electrical engineering, logic circuits, microcontrollers, C language, and assemblers.

To understand the hardware functions of the 78K0R microcontroller or RL78 family
→ Refer to the **User's Manual** of each product.

Conventions

Data significance:	Higher digits on the left and lower digits on the right
Note:	Footnote for item marked with Note in the text
Caution:	Information requiring particular attention
Remark:	Supplementary information
Numerical representation:	Binary...XXXX or XXXXB
	Decimal...XXXX
	Hexadecimal...0xXXXX
Prefixes indicating power of 2 (address space and memory capacity):	
	K (kilo) $2^{10} = 1024$
	M (mega) $2^{20} = 1024^2$

Related Documents

Refer to the documents listed below when using this manual.

The related documents indicated in this publication may include preliminary versions.

However, preliminary versions are not marked as such.

Documents related to development tools (User's Manuals)

Document Name		Document No.
RI Series	Start	R20UT0509E
	Message	R20UT0510E
RI78V4	Coding	R20UT0511E
	Debug	R20UT0520E
	Analysis	This document
	Internal Structure	R20UT0514E
RI850V4	Coding	R20UT0515E
	Debug	R20UT0516E
	Analysis	R20UT0517E
	Internal Structure	R20UT0518E
RI850MP	Coding	R20UT0519E
CubeSuite+ Integrated Development Environment	Start	R20UT0545E
	78K0 Design	R20UT0546E
	78K0R Design	R20UT0547E
	RL78 Design	R20UT0548E
	V850 Design	R20UT0549E
	R8C Design	R20UT0550E
	78K0 Coding	R20UT0551E
	RL78,78K0R Coding	R20UT0552E
	V850 Coding	R20UT0553E
	Coding for CX Compiler	R20UT0554E
	R8C Coding	R20UT0576E
	78K0 Build	R20UT0555E
	RL78,78K0R Build	R20UT0556E
	V850 Build	R20UT0557E
	Build for CX Compiler	R20UT0558E
	R8C Build	R20UT0575E
	78K0 Debug	R20UT0559E
78K0R Debug	R20UT0560E	
RL78 Debug	R20UT0561E	

Caution The related documents listed above are subject to change without notice. Be sure to use the latest edition of each document when designing.

All trademarks or registered trademarks in this document are the property of their respective owners.

[MEMO]

[MEMO]

[MEMO]

TABLE OF CONTENTS

CHAPTER 1 GENERAL ... 9

1.1 Overview ... 9

1.2 Features ... 9

CHAPTER 2 FUNCTIONS ... 10

2.1 Trace Form ... 10

2.2 Trace Data ... 10

2.2.1 Collecting positions and collected data ... 10

2.2.2 Time an accuracy ... 11

2.3 Debugging Procedure ... 12

APPENDIX A WINDOW REFERENCE ... 17

A.1 Description ... 17

APPENDIX B MESSAGES ... 58

B.1 Overview ... 58

B.2 Error Messages ... 58

APPENDIX C INDEX ... 60

CHAPTER 1 GENERAL

The CubeSuite+ is an integrated development environment used to carry out tasks such as design, coding, build and debug for developing application systems for microcontrollers manufactured by Renesas Electronics.

This manual describes the performance analyzer. This tool is useful for analyzing programs using the "RI78V4" real-time OS functionality within this integrated program-development process.

1.1 Overview

As the performance of microprocessors has increased, application programs have grown in scale and complexity.

With conventional debuggers, theoretical debugging of such application programs is simple, but time-related analysis is not. It is difficult and takes a very long time, for example, to analyze errors such as those caused by incorrect processing timing, or to evaluate the performance of the entire system.

To solve these problems, Renesas Electronics Corporation has developed powerful microprocessors such as the RL78, 78K0R. Renesas Electronics Corporation also provides the performance analyzer to support the quantitative performance analysis of programs.

The performance analyzer is a performance analysis tool for examining the execution transition statuses and the CPU usage of processing programs that embed the RI78V4 for the RL78, 78K0R. Being connected with the CubeSuite+, the performance analyzer achieves a function for collecting data of tracing the event occurrences (issuance of service calls, occurrence of interrupts, etc.) and presenting the trace data graphically.

The performance analyzer therefore allows the user to readily analyze the execution transition statuses and the CPU usage of processing programs.

1.2 Features

The performance analyzer has the following features:

- Graphical display of the execution transition statuses of processing programs

The graphically displayed the execution transition status of the processing program in which the RI78V4 is embedded (horizontal axis = time, vertical axis = task name, etc.) permits analysis of execution transition statuses, such as task switching caused by service call issuance and transferring the control to the interrupt handler caused by the occurrence of interrupts. Since all accesses to an object (such as semaphore or eventflag) are marked upon issuance of a service call from a processing program, the usage of objects can also be checked.

- Graphical display of the CPU usage of processing programs

The CPU usage (total execution time, code coverage, etc.) of a processing program executed within a specified section can be displayed, which enables the quantitative performance analysis for processing programs.

- Linking with the CubeSuite+

The performance analyzer can open the Editor panel, Disassemble panel, and Memory panel of the CubeSuite+, which enables quick identification of locations where a problem has occurred.

CHAPTER 2 FUNCTIONS

This chapter describes main functions of the performance analyzer.

2.1 Trace Form

The performance analyzer supports the following trace form.

- Hard trace form

Using the trace function provided by the debug tool that is connected to the CubeSuite+, the performance analyzer collects trace data and stores it to the trace memory of the debug tool.

Using this form, trace data can therefore be collected without modifying the processing program code.

Remark The performance analyzer uses the following resources of the debug tool, when switching the AZ trace mode to the ON state.

Resource Name	Required Quantity
Point trace event (for write access)	1

2.2 Trace Data

2.2.1 Collecting positions and collected data

The following lists the trace data to be collected and positions where they are collected.

Table 2-1. Collected Trace Data and Collecting Positions

Collecting Positions	Collected Data
Service call entry	Time Service call function code ID of object subject to execution by service call Service call issuance address
Service call exit	Time Service call return value
Interrupt handler entry	Time Address at which execution returns from interrupt handler
Interrupt handler exit	Time
Occurrence of task switching	Time ID of a task to which the operation will move (or ID that indicates idle routine is entered)
Task entry	Time ID of task to be activated Task activation address

Note that the following items cannot be detected as trace data for the performance analyzer.

- Address at which ext_tsk is issued
- Entry/exit of reset, NMI, exception (software exception, exception trap)
- Entry/exit of maskable interrupts whose interrupt handler has not been registered

- Boot processing entry/exit
- Initialization routine entry/exit
- Cyclic handler entry/exit

Since the RI78V4 assigns the same function code to service call names to which an "i" is prefixed/not prefixed listed below, the performance analyzer cannot identify them.

The performance analyzer therefore handles these service calls without an "i" being prefixed.

- sta_tsk/ista_tsk
- chg_pri/ichg_pri
- can_wup/ican_wup
- sus_tsk/isus_tsk
- rsm_tsk/irsm_tsk
- frsm_tsk/ifrsm_tsk

2.2.2 Time and accuracy

- When using the IECUBE as debug tool

The accuracy of the time collected as trace data depends on the setting of the [Rate of frequency division of trace time tag] property in the [Trace] category of the [Debug Tool Settings] tab in the Property panel of the CubeSuite+. If the system clock is set to the STOP or IDLE mode, however, the performance analyzer cannot collect an accurate time, and the collected value is therefore not guaranteed (This is because the performance analyzer calculates the time taken by processing program execution, based on the system clock.).

- When using the simulator as debug tool

Specify [No] with the [Accumulate trace time] property in the [Trace] category on the [Debug Tool Settings] tab in the Property panel of the CubeSuite+.

Unless this property is set to [No], the accurate time cannot be collected.

2.3 Debugging Procedure

This section describes the procedure for debugging using the performance analyzer.

(1) Stating CubeSuite+

Start the CubeSuite+ and then connect the debug tool to be used to it (select the [Debug] menu >> [Connect to Debug Tool] in the Main window of the CubeSuite+).

(2) Starting performance analyzer

Start the performance analyzer to be used (select the [View] menu >> [Real-time OS] >> [Performance Analyzer] in the Main window of the CubeSuite+).

After the performance analyzer is started, the following AZ78K0R window appears.

At this time, make sure that the message "Connected" is displayed on the statusbar (Connection status area) in the AZ78K0R window.

Figure 2-1. Starting Performance Analyzer

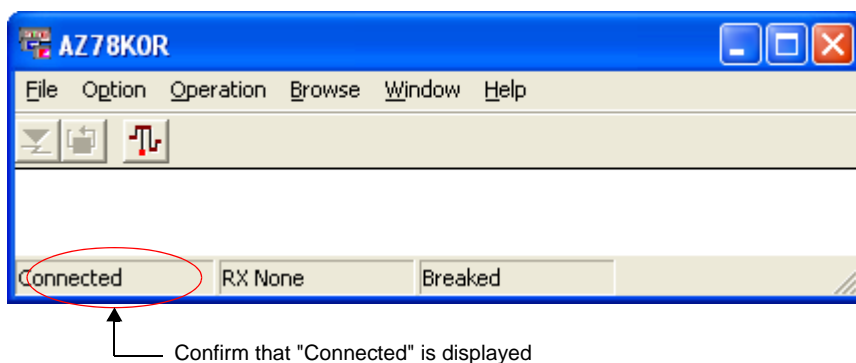

(3) Downloading a load module

Download the load module (select the [Debug] menu >> [Download]) that has been linked with the RI78V4 into the debug tool.

At this time, make sure that the message "RX Loaded" is displayed on the statusbar (Load module status area) in the AZ78K0R window.

Figure 2-2. Downloading A Load Module

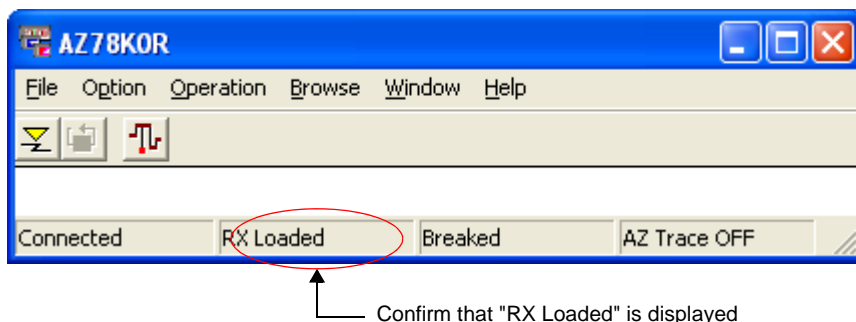

(4) Switching the AZ trace mode

Click the  button in the [AZ78K0R window](#) to turn on AZ trace mode.

At this time, make sure that the message "AZ Trace ON" is displayed on the statusbar (AZ trace mode status area) in the [AZ78K0R window](#).

Figure 2-3. Switching The AZ Trace Mode

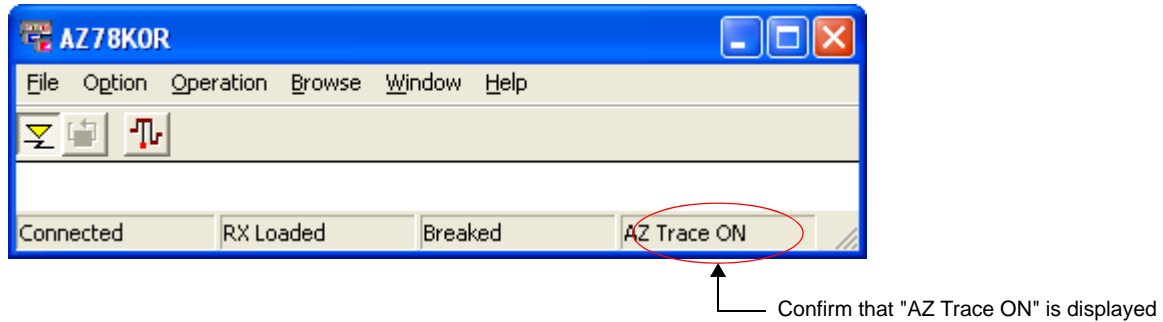
**(5) Execution of processing program**

Run the processing program on the CubeSuite+.
Collection of trace data then starts.

(6) Stop of processing program

Stop execution of the processing program on the CubeSuite+. If a breakpoint has been set, wait until the processing program breaks.
Collection of trace data then ends.

(7) Loading of trace data

Click the  button in the [AZ78K0R window](#) to load trace data collected for the performance analyzer.

(8) Verification in AZ:Analyze window

Click the  button in the AZ78K0R window to open the AZ:Analyze window.

In this window and each of the windows that can be opened from this window, analysis related to time, such as bugs caused by processing timing and evaluation of entire system performance.

Figure 2-4. Verification in AZ:Analyze Window

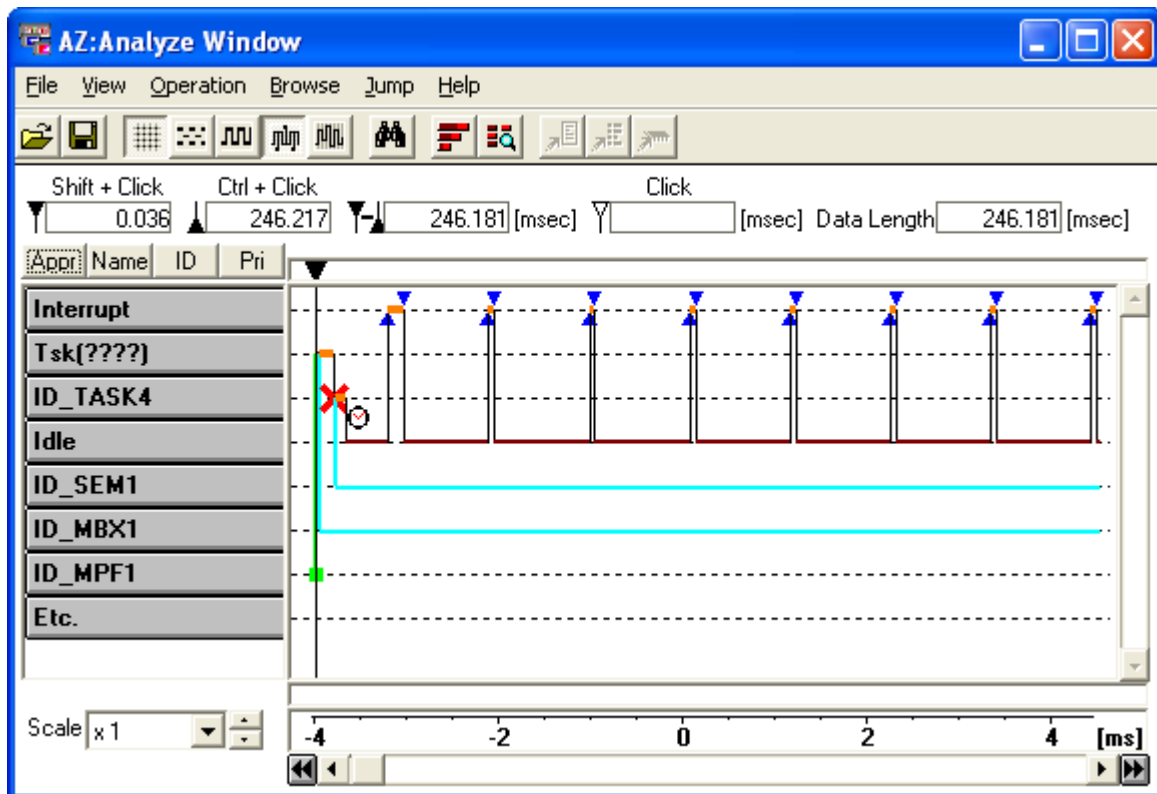

Remark For how to read the execution transition map displayed in this window, refer to "[\[How to read execution transition map\]](#)" and "[\[How to verify execution transition map\]](#)".

(9) Verification in **Pattern Search dialog box**

Click the  button in the **AZ:Analyze window** to open the **Pattern Search dialog box**.

In this window, the point at which a specific event occurred can be searched for, based on the execution transition map displayed in the **AZ:Analyze window**.

Figure 2-5. Verification in Pattern Search Dialog Box

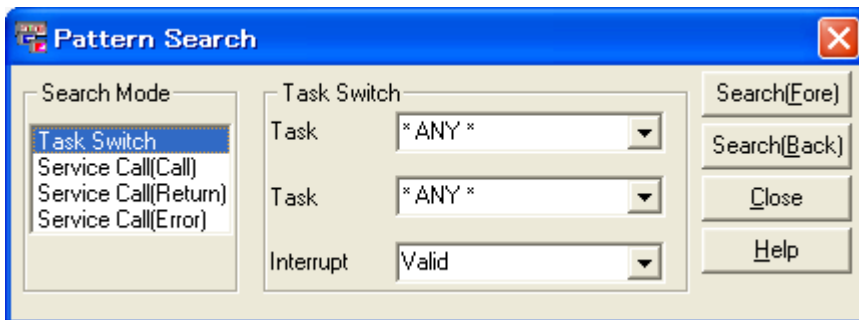

Remark For how to search for the point at which a specific event occurred, refer to "[How to search]".

(10) Verification in **AZ:Cpu window**

Click the  button in the **AZ:Analyze window** to open the **AZ:Cpu window**.

In this window, the CPU usage in a section between the up cursor and down cursor in the **AZ:Analyze window** can be checked.

Figure 2-6. Verification in AZ:Cpu Window

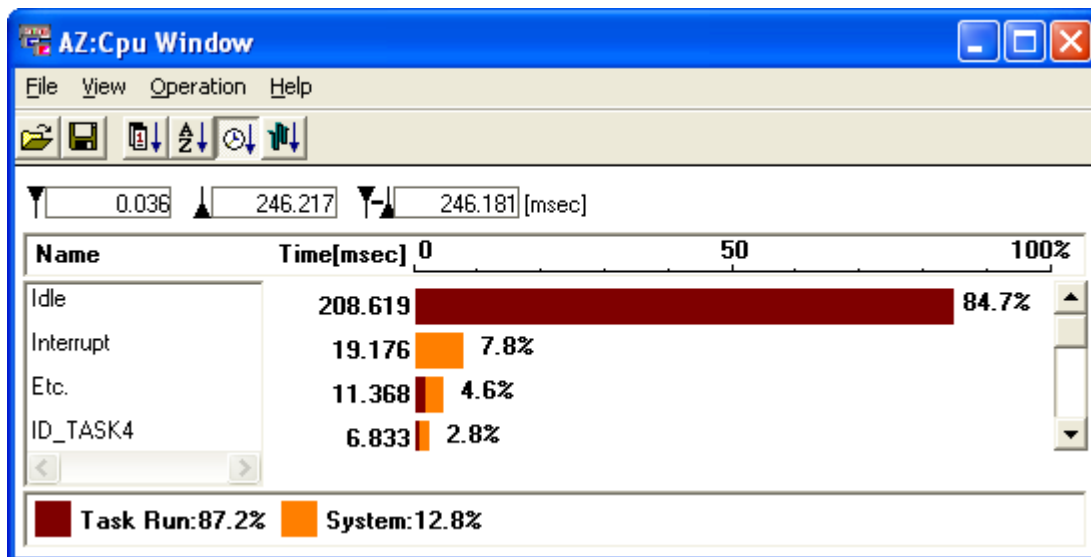

Remark For how to count the CPU usage, refer to "[Count method]".

(11) Verification in AZ:Trace View window

Click the  button in the AZ:Analyze window to open the AZ:Trace View window.

In this window, information obtained from the execution transition map in the AZ:Analyze window can be viewed in list form.

Figure 2-7. Verification in AZ:Trace View Window

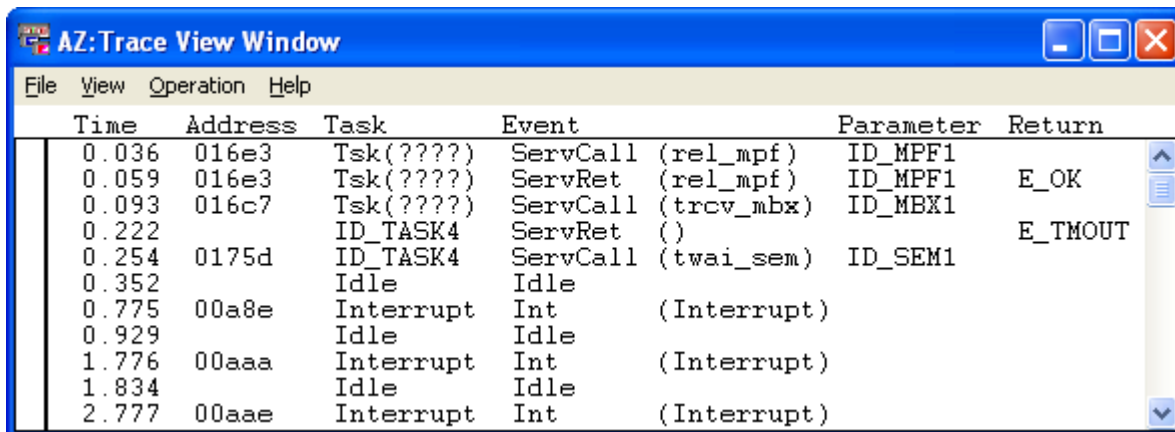

Time	Address	Task	Event	Parameter	Return
0.036	016e3	Tsk(????)	ServCall (rel_mpf)	ID_MPF1	
0.059	016e3	Tsk(????)	ServRet (rel_mpf)	ID_MPF1	E_OK
0.093	016c7	Tsk(????)	ServCall (trcv_mbx)	ID_MBX1	
0.222		ID_TASK4	ServRet ()		E_TMOUT
0.254	0175d	ID_TASK4	ServCall (twai_sem)	ID_SEM1	
0.352		Idle	Idle		
0.775	00a8e	Interrupt	Int (Interrupt)		
0.929		Idle	Idle		
1.776	00aaa	Interrupt	Int (Interrupt)		
1.834		Idle	Idle		
2.777	00aae	Interrupt	Int (Interrupt)		

Remark For how to read the list displayed in this window, refer to "[How to read the list]".

(12) Verification in Trace Search dialog box

Click the [View] menu >> [Find...] in the AZ:Trace View window to open the Trace Search dialog box.

In this window, specific information (trace data) can be searched for from the list displayed in the AZ:Trace View window.

Figure 2-8. Verification in Trace Search Dialog Box

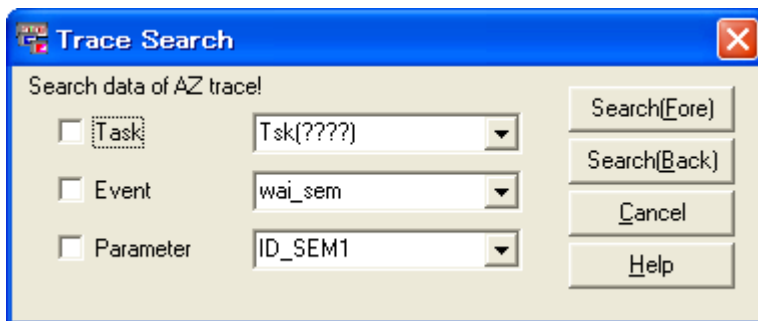

Search data of AZ trace!

Task: Tsk(????)

Event: wai_sem

Parameter: ID_SEM1

Buttons: Search[Fore], Search[Back], Cancel, Help

Remark For how to search for specific information (trace data), refer to "[How to search]".

APPENDIX A WINDOW REFERENCE

This appendix provides detailed explanations of windows and dialog boxes used for analyzing with the performance analyzer.

A.1 Description

The following shows the list of windows and dialog boxes of the performance analyzer.

Table A-1. List of Windows and Dialog Boxes

Window/Dialog Box Name	Function
AZ78K0R window	Central window for using the functions provided by the performance analyzer.
Open/Save As dialog box	Specifies the file name when loading a file that contains information to be displayed in the AZ:Analyze window and AZ:Cpu window , or when saving information displayed in the AZ:Analyze window , AZ:Cpu window and AZ:Trace View window as a file.
AZ:Analyze window	Displays information obtained from the trace data loaded into the AZ78K0R window , in the form of an execution transition map.
Pattern Search dialog box	Searches for the point at which a specific event occurred, based on the execution transition map displayed in the AZ:Analyze window .
AZ:Cpu window	Displays the CPU usage in a section between the up cursor and down cursor in the AZ:Analyze window .
AZ:Trace View window	Lists information obtained from the execution transition map in the AZ:Analyze window .
Trace Search dialog box	Searches for specific information (trace data) based on the list displayed in the AZ:Trace View window .
About dialog box	Displays the version information of the performance analyzer.
AZ:Error dialog box	Displays the error information of the performance analyzer.

AZ78K0R window

Central window for using the functions provided by the performance analyzer.

Figure A-1. AZ78K0R Window

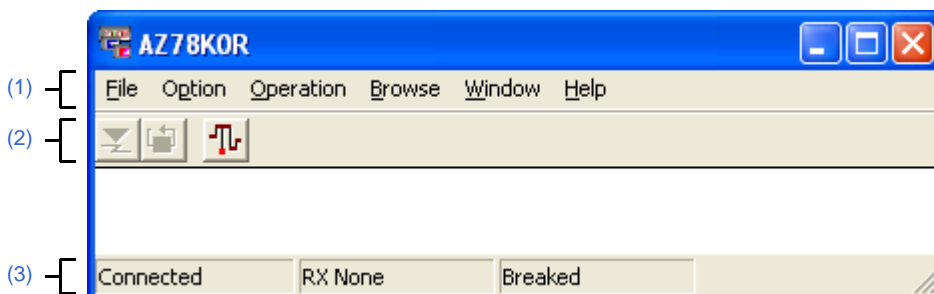

The following items are explained here.

- [How to open]
- [Description of each area]
- [Caution]

[How to open]

- In the menubar of the main window, select [Realtime OS] >> [Performance Analyzer] from the [View] menu.

[Description of each area]

(1) Menubar

This bar consists of the following menu items.

(a) [File] menu



Exit	Terminates the performance analyzer. The function of this item is same as that of the  button.
------	--

(b) [Option] menu

Tool Bar	Switches displaying and hiding the Toolbar (default: displayed).
Status Bar	Switches displaying and hiding the Statusbar (default: displayed).

(c) [Operation] menu

AZ Trace ON	Turns on the AZ trace mode. Trace data is collected into the trace memory of the debug tool by running a processing program while the AZ trace mode is ON. The function of this item is same as that of the  button.
-------------	---

AZ Trace OFF	<p>Turns off the AZ trace mode.</p> <p>Trace data is not collected into the trace memory of the debug tool if a processing program is executed while the AZ trace mode is OFF.</p> <p>The function of this item is same as that of the  button.</p>
Upload	<p>Loads trace data stored in the trace memory.</p> <p>The AZ trace mode is automatically turned off when loading of trace data is finished.</p> <p>This menu is unavailable if trace data has not been collected.</p> <p>The function of this item is same as that of the  button.</p>

(d) [Browse] menu

Analyze...	<p>Opens the AZ:Analyze window in Active mode.</p> <p>If loading of trace data has been finished in this window, the execution transition map is displayed in the corresponding window.</p> <p>The function of this item is same as that of the  button.</p>
------------	---

(e) [Window] menu



Close All	Closes windows and dialog boxes other than this window.
-----------	---

(f) [Help] menu

This Window	Displays the help window for this window.
Help Topics	Opens the online help, with the [Search] tab displayed.
About...	<p>Opens the About dialog box.</p> <p>The version information of the performance analyzer is displayed.</p>

(2) Toolbar

This bar consists of the following buttons.

	<p>Switches the AZ trace mode.</p> <p>Trace data is collected into the trace memory of the debug tool by running a processing program while the AZ trace mode is ON.</p> <p>Trace data is not collected into the trace memory of the debug tool if a processing program is executed while the AZ trace mode is OFF.</p> <p>The function of this item is the same as that of [AZ Trace ON] or [AZ Trace OFF] in the [Operation] menu.</p>
	<p>Loads trace data stored in the trace memory.</p> <p>The AZ trace mode is automatically turned off when loading of trace data is finished.</p> <p>This button is unavailable if trace data has not been collected.</p> <p>The function of this item is the same as that of [Upload] in the [Operation] menu.</p>
	<p>Opens the AZ:Analyze window in Active mode.</p> <p>If loading of trace data has been finished in this window, the execution transition map is displayed in the corresponding window.</p> <p>The function of this item is the same as that of [Analyze...] in the [Browse] menu.</p>

(3) Statusbar

This bar consists of the following areas.

Figure A-2. Statusbar (AZ78K0R Window)

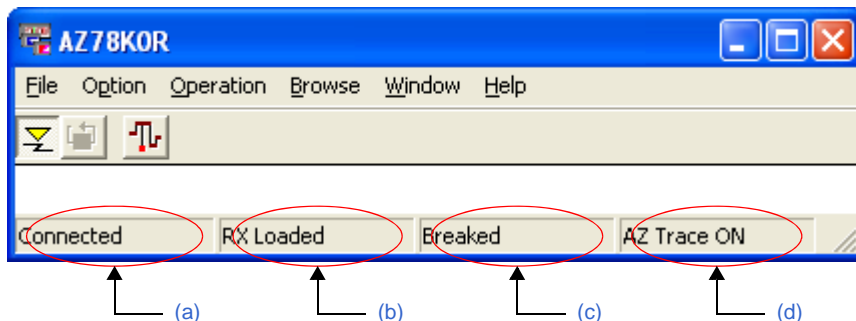

(a) Connection status area

This area indicates the status of connection with the CubeSuite+.

Connected	Connected to the CubeSuite+.
Not Connected	Not connected to the CubeSuite+.

(b) Load module status area

This area indicates the state of the load module to be loaded onto the debug tool.
 This area is not displayed if the performance analyzer is not connected to the CubeSuite+.

RX Loaded	A load module linked with the RI78V4 has been downloaded.
RX None	No load modules linked with the RI78V4 have been downloaded.

(c) Load module execution status area

This area indicates the state of the program execution.
 This area is not displayed if the performance analyzer is not connected to the CubeSuite+.

Running	Status of program being execution.
Broken	Status of program operation undergoing break.

(d) AZ trace mode status area

This area indicates the current state of AZ trace mode.
 This area is not displayed when the performance analyzer is not connected with the CubeSuite+, or if no load modules linked with the RI78V4 have been downloaded.

AZ Trace ON	Status where AZ trace ON has been set.
AZ Trace OFF	Status where AZ trace OFF has been set.

[Caution]

- When switching the AZ trace mode to the ON state, a load module linked with the RI78V4 must already be downloaded to the debug tool ([RX Loaded] is displayed in the statusbar).
- Event setting for the debug tool is performed when the AZ trace mode is switched to the ON state.
Refer to "[2.1 Trace Form](#)" for details on events on the debug tool side, which are required for switching the AZ trace mode.

Open/Save As dialog box

Specifies the file name when loading a file that contains information to be displayed in the [AZ:Analyze window](#) and [AZ:Cpu window](#), or when saving information displayed in the [AZ:Analyze window](#), [AZ:Cpu window](#) and [AZ:Trace View window](#) as a file.

Figure A-3. Open/Save As Dialog Box (When Loading)

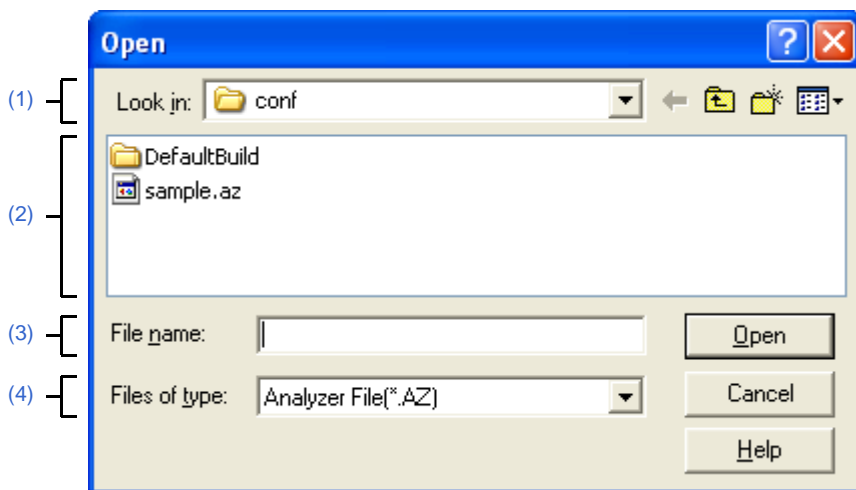
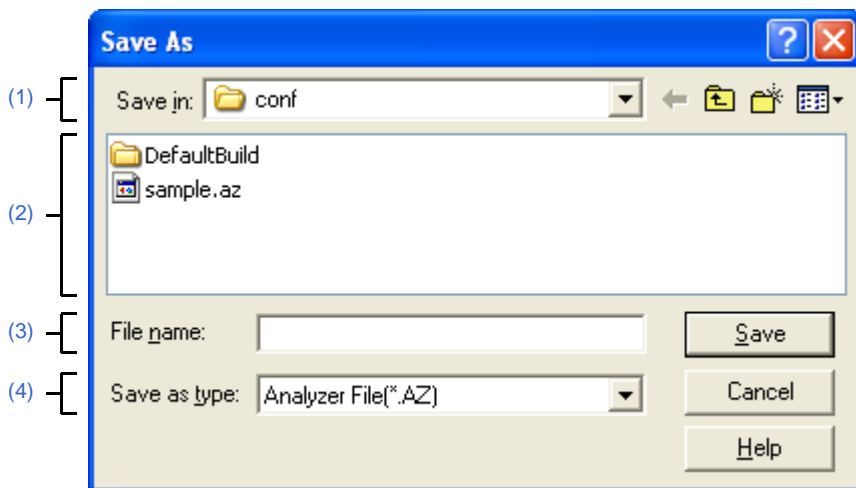

Figure A-4. Open/Save As Dialog Box (When Saving)



The following items are explained here.

- [\[How to open\]](#)
- [\[Description of each area\]](#)
- [\[Function buttons\]](#)
- [\[Restored file information\]](#)

[How to open]

[When loading]

- In the menubar of the [AZ:Analyze window](#) or [AZ:Cpu window](#), select [Open...] from the [File] menu.
- In the toolbar of the [AZ:Analyze window](#) or [AZ:Cpu window](#), click the  button.

- In the [AZ:Analyze window](#) or [AZ:Cpu window](#), press the [Alt], [F] and [O] keys in that order.
- In the [AZ:Analyze window](#) or [AZ:Cpu window](#), press the [Ctrl] + [O] keys at the same time.

[When saving]

- In the menubar of the [AZ:Analyze window](#), [AZ:Cpu window](#) or [AZ:Trace View window](#), select [Save...] from the [File] menu.
- In the toolbar of the [AZ:Analyze window](#) or [AZ:Cpu window](#), click the  button.
- In the [AZ:Analyze window](#), [AZ:Cpu window](#) or [AZ:Trace View window](#), press the [Alt], [F] and [S] keys in that order.
- In the [AZ:Analyze window](#), [AZ:Cpu window](#) or [AZ:Trace View window](#), press the [Ctrl] + [S] keys at the same time.

[Description of each area]

(1) [Look in]/[Save in] area

This area is used to select the folder where a target file is stored or is to be stored.

(2) File list area

This area lists the files that match the conditions selected in the file location area and file type area.

(3) [File name] area

This area is used to specify the name of a target file.

(4) [Files of type]/[Save as type] area

This area is used to select the type of files to be displayed in the file list area.

The default type displayed in this area varies depending on the window from which the file is called, as shown below.

Window Name	File of Type
AZ:Analyze window	Analyze File (*.AZ)
AZ:Cpu window	Cpu File (*.AZC)
AZ:Trace View window	Trace View File (*.AZT)

[Function buttons]

Button	Function
Open/Save	Loads the file that matches the conditions specified in this dialog box. Saves the information displayed in the window into the file that matches the conditions specified in this dialog box.
Cancel	Closes this dialog box. The function of this item is same as that of the  button.
Help	Displays the help window for this dialog box.

[Restored file information]

Handling of files loaded in this dialog box varies depending on the window from which the file is called, as shown below.

- [AZ:Analyze window](#)

Information of the file loaded into the [AZ:Analyze window](#), which called the file, will be restored. To maintain the previous information, switch to the Hold mode the [AZ:Analyze window](#) that has information to be maintained, open another [AZ:Analyze window](#), and then load the file from the window in the Hold mode.

- [AZ:Cpu window](#)

A new [AZ:Cpu window](#) opens, and information of the file loaded into the window is restored. The [AZ:Cpu window](#) that called the file therefore maintains the previous information.

AZ:Analyze window

Displays information obtained from the trace data loaded into the [AZ78K0R window](#), in the form of an execution transition map.

Figure A-5. AZ:Analyze Window

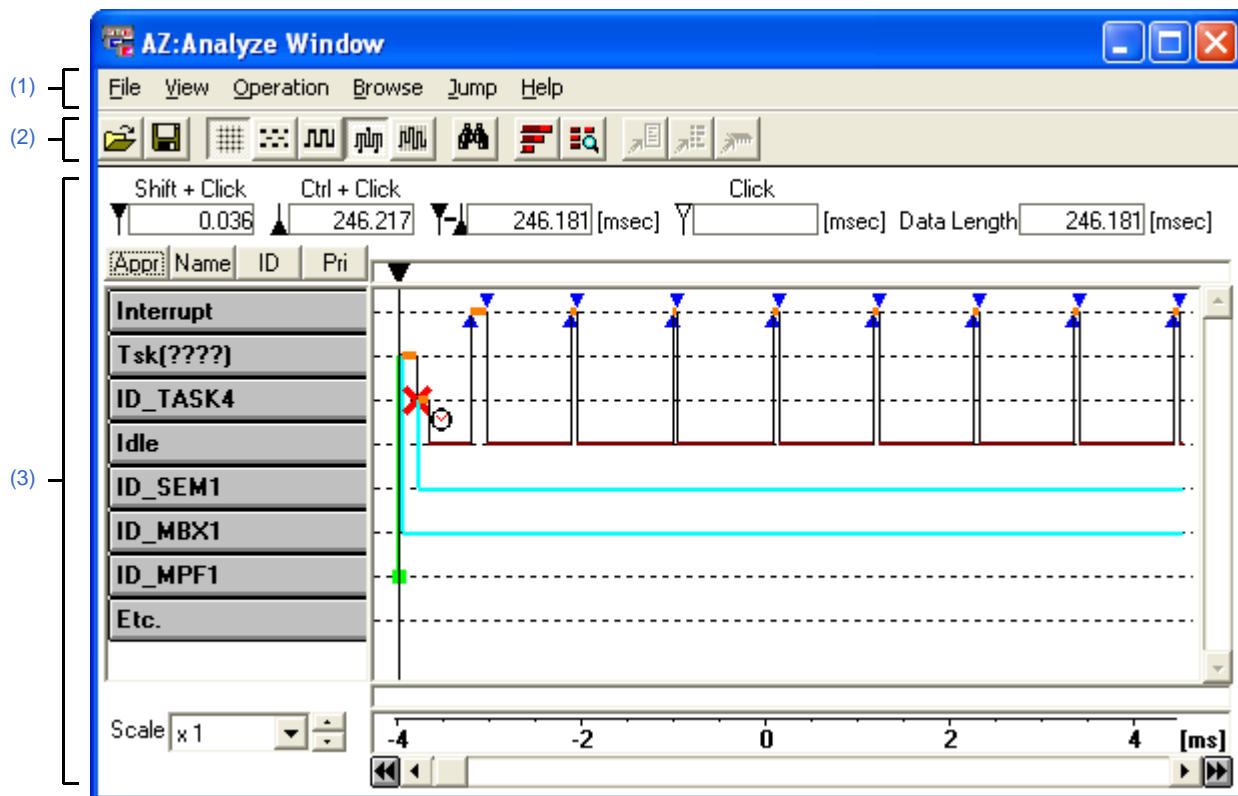

The following items are explained here.

- [\[How to open\]](#)
- [\[Description of each area\]](#)
- [\[Object button display format\]](#)
- [\[How to read execution transition map\]](#)
- [\[How to verify execution transition map\]](#)

[How to open]



- In the menubar of the [AZ78K0R window](#), select [Analyze...] from the [Browse] menu.
- In the toolbar of the [AZ78K0R window](#), click the  button.
- In the [AZ78K0R window](#), press the [Alt], [B] and [A] keys in that order.
- In the [AZ78K0R window](#), press the [Ctrl] + [A] keys at the same time.

[Description of each area]



(1) Menubar

This bar consists of the following menu items.

(a) [File] menu

Open...	<p>Opens the Open/Save As dialog box.</p> <p>Loads the file that contains information to be displayed in this window (extension: .AZ).</p> <p>The function of this item is same as that of the  button.</p>
Save...	<p>Opens the Open/Save As dialog box.</p> <p>Specifies the name of the file into which information displayed in this window is saved (extension: .AZ).</p> <p>The function of this item is same as that of the  button.</p>
Close	<p>Closes this window.</p> <p>The function of this item is same as that of the  button.</p>



(b) [View] menu

Grid mode	Specifies whether to display gridlines in the execution transition map.
Grid	Displays gridlines (default).
Ungrid	Does not display gridlines.
View mode	Specifies the execution transition map display mode.
Simple	<p>Displays the execution transition map in Simple mode.</p> <p>The function of this item is same as that of the  button.</p>
Standard	<p>Displays the execution transition map in Standard mode.</p> <p>The function of this item is same as that of the  button.</p>
Detail	<p>Displays the execution transition map in Detail mode (default).</p> <p>The function of this item is same as that of the  button.</p>
Equal	<p>Displays the execution transition map in Equal mode.</p> <p>The function of this item is same as that of the  button.</p>
Small	<p>Shrinks the execution transition map display to 1/2.</p> <p>The effect is the same as selecting "x 1/2" in the Display scale change area.</p>
Large	<p>Magnifies the execution transition map display by 2.</p> <p>The effect is the same as selecting "x 2" in the Display scale change area.</p>
Find...	<p>Opens the Pattern Search dialog box.</p> <p>Searches for the point at which a specific event occurred, based on the execution transition map displayed in this window.</p> <p>The function of this item is same as that of the  button.</p>
Sort object	Specifies the Object buttons display order.
Appear	Displays trace data in the order of detection (default).
Name	Displays the objects in the order of ASCII code.
ID	Displays the objects in the ID order.
Priority	Displays the objects in the priority order (valid for tasks only).



(c) [Operation] menu

Active	Switches this window to the Active mode. This window is in the Active mode when opened. This window opens automatically when the performance analyzer is started.
Hold	Switches this window to the Hold mode.

(d) [Browse] menu

CPU...	Opens the AZ:Cpu window in Active mode. Information later than the position pointed to by the Up temporary cursor in the execution transition map is displayed in the window. If the AZ:Cpu window has already been opened in the Active mode, information displayed in the window is updated. The function of this item is same as that of the  button.
Trace View...	Opens the AZ:Trace View window in Active mode. Information later than the position pointed to by the Up temporary cursor in the execution transition map is displayed in the window. If the AZ:Trace View window has already been opened in the Active mode, information displayed in the window is updated. The function of this item is same as that of the  button.

(e) [Jump] menu





Source Text...	Opens the Editor panel of CubeSuite+. Information later than the position pointed to by the Up temporary cursor in the execution transition map is displayed in the panel. If the Editor panel has already been opened in the Active mode, information displayed in the panel is updated. The function of this item is same as that of the  button.
Assemble...	Opens the Disassemble panel of CubeSuite+. Information later than the position pointed to by the Up temporary cursor in the execution transition map is displayed in the panel. If the Disassemble panel has already been opened in the Active mode, information displayed in the panel is updated. The function of this item is same as that of the  button.
Memory...	Opens the Memory panel of the CubeSuite+. Information later than the position pointed to by the Up temporary cursor in the execution transition map is displayed in the panel. If the Memory panel has already been opened in the Active mode, information displayed in the panel is updated. The function of this item is same as that of the  button.



(f) [Help] menu

This Window	Displays the help window for this window.
Help Topics	Opens the online help, with the [Search] tab displayed.

(2) Toolbar

This bar consists of the following buttons.

	<p>Opens the Open/Save As dialog box.</p> <p>Loads the file that contains information to be displayed in this window (extension: .AZ).</p> <p>The function of this item is the same as that of [Open...] int the [File] menu.</p>
	<p>Opens the Open/Save As dialog box.</p> <p>Specifies the name of the file into which information displayed in this window is saved (extension: .AZ).</p> <p>The function of this item is the same as that of [Save...] int the [File] menu.</p>
	<p>Specifies whether to display gridlines in the execution transition map (default: Displays gridlines).</p>
	<p>Displays the execution transition map in Simple mode.</p> <p>The function of this item is the same as that of [View mode] >> [Simple] int the [View] menu.</p>
	<p>Displays the execution transition map in Standard mode</p> <p>The function of this item is the same as that of [View mode] >> [Standard] int the [View] menu.</p>
	<p>Displays the execution transition map in Detail mode (default).</p> <p>The function of this item is the same as that of [View mode] >> [Detail] int the [View] menu.</p>
	<p>Displays the execution transition map in Equal mode.</p> <p>The function of this item is the same as that of [View mode] >> [Equal] int the [View] menu.</p>
	<p>Opens the Pattern Search dialog box.</p> <p>Searches for the point at which a specific event occurred, based on the execution transition map displayed in this window.</p> <p>The function of this item is the same as that of [Find...] int the [View] menu.</p>
	<p>Opens the AZ:Cpu window in Active mode.</p> <p>Information later than the position pointed to by the Up temporary cursor in the execution transition map is displayed in the window.</p> <p>If the AZ:Cpu window has already been opened in the Active mode, information displayed in the window is updated.</p> <p>The function of this item is the same as that of [CPU...] int the [Browse] menu.</p>
	<p>Opens the AZ:Trace View window in Active mode.</p> <p>Information later than the position pointed to by the Up temporary cursor in the execution transition map is displayed in the window.</p> <p>If the AZ:Trace View window has already been opened in the Active mode, information displayed in the window is updated.</p> <p>The function of this item is the same as that of [Trace View...] int the [Browse] menu.</p>
	<p>Opens the Editor panel of CubeSuite+.</p> <p>Information later than the position pointed to by the Up temporary cursor in the execution transition map is displayed in the panel.</p> <p>If the Editor panel has already been opened in the Active mode, information displayed in the panel is updated.</p> <p>The function of this item is the same as that of [Source Text...] int the [Jump] menu.</p>

	<p>Opens the Disassemble panel of CubeSuite+.</p> <p>Information later than the position pointed to by the Up temporary cursor in the execution transition map is displayed in the panel.</p> <p>If the Disassemble panel has already been opened in the Active mode, information displayed in the panel is updated.</p> <p>The function of this item is the same as that of [Assemble...] in the [Jump] menu.</p>
	<p>Opens the Memory panel of the CubeSuite+.</p> <p>Information later than the position pointed to by the Up temporary cursor in the execution transition map is displayed in the panel.</p> <p>If the Memory panel has already been opened in the Active mode, information displayed in the panel is updated.</p> <p>The function of this item is the same as that of [Memory...] in the [Jump] menu.</p>

(3) Information area

This area consists of the following informations.

Figure A-6. Information Area (AZ:Analyze Window)

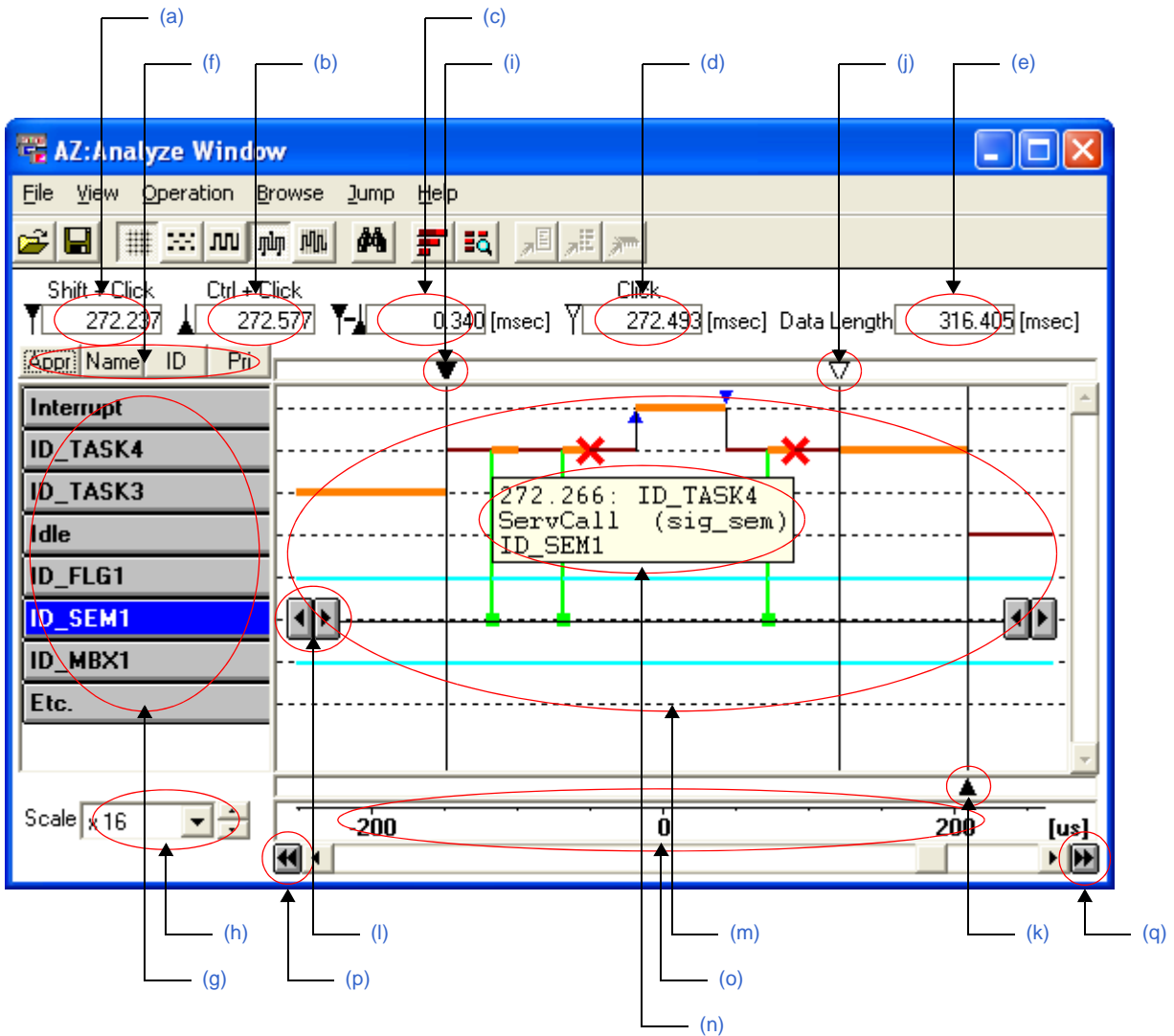

(a) Time up to count start point

This area displays the time up to the CPU usage counting start point.

The time up to the count start point is a relative time from when trace processing starts until the execution reaches the [Up cursor](#) position (unit: ms).

(b) Time up to count end point

This area displays the time up to the CPU usage counting end point.

The time up to the count end point is a relative time from when trace processing starts until the execution reaches the [Down cursor](#) position (unit: ms).

(c) Total time

This area displays the total time of the CPU usage.

The total time is a relative time indicated from the [Up cursor](#) position to the [Down cursor](#) position (unit: ms).

(d) Time up to the point subject to manipulation

This area displays the times up to when various types of manipulation (such as opening of the panels of the CubeSuite+, and execution of simple search) are performed.

The time up to the point subject to manipulation is an absolute time from when trace processing starts until the execution reaches the [Up temporary cursor](#) (unit: ms).

(e) Trace time

The trace time is a relative time from the start to the end of trace processing (unit: ms).

(f) Sort buttons

This button is used to change the [Object buttons](#) display order.

This area consists of the following buttons.

Button	Function
Appr	Displays trace data in the order of detection (default).
Name	Displays the objects in the order of ASCII code.
ID	Displays the objects in the ID order.
Pri	Displays the objects in the priority order (valid for tasks only).

(g) Object buttons

These buttons display the objects (interrupt handlers, tasks, idle routines, or etc.) detected as trace data.

Remark For details on the object button display format, refer to "[\[Object button display format\]](#)".

(h) Display scale change area

This area is used to change the display scale of the execution transition map.

The drop-down list consists of the following items.

x <i>n</i>	Magnifies the execution transition map by <i>n</i> .
x 1/ <i>n</i>	Shrinks the execution transition map to 1/ <i>n</i> .

(i) Up cursor

This cursor specifies the point from which the CPU usage is counted.

This cursor can be moved by clicking it with the SHIFT key being pressed in the execution transition map.

(j) Up temporary cursor

This cursor specifies the point from which a manipulation (such as opening of the panels of the CubeSuite+, and execution of simple search) is performed.

This cursor can be moved by dragging it with the SHIFT key being pressed in the execution transition map.

Remark When the [Up cursor](#) is moved, this cursor also moves to the same position.

(k) Down cursor



This cursor specifies the point at which counting of the CPU usage ends.

This cursor can be moved by clicking it with the CTRL key being pressed in the execution transition map.

(l) Simple search buttons

These buttons are displayed when an [Object buttons](#) is clicked, and used to perform the following manipulations.

These buttons are hidden when the [Object buttons](#) is clicked again.

Button	Function
	Searches for the point at which an event related to the relevant object occurred, from the search start point toward the reverse direction to the time axis. The Up temporary cursor shows the detected point. A beep is generated if no events have occurred at any location.
	Searches for the point at which an event related to the relevant object occurred, from the search start point toward the time axis direction. The Up temporary cursor shows the detected point. A beep is generated if no events have occurred at any location.

(m) Execution transition map







This area displays the processing program analysis result.

- Remarks 1.** Refer to "[\[How to read execution transition map\]](#)" for details on marks shown in the execution transition map.
- 2.** If the number of OS resources subject to display exceeds 1,000, this area may not be displayed correctly.

(n) Pop-up area

The following information related to the position pointed to by the mouse pointer pops up.

Mouse Pointer	Meaning
Object buttons	Object name
Black vertical line 	The following information related to processing program switching - Time taken to generate processing program switching (unit: ms) - Name of processing program before switching - Name of processing program after switching

Orange horizontal line 	The following information related to service calls <ul style="list-style-type: none"> - Time taken to issue a service call (unit: ms) - Time taken to return from a service call (unit: ms) - Service call processing time (unit: ms) - Service call name - Name of object subject to manipulation by service call
Orange horizontal line 	The following information related to interrupts <ul style="list-style-type: none"> - Time taken to generate an interrupt (unit: ms) - Time taken to finish interrupt handler processing (unit: ms) - Interrupt handler processing time (unit: ms)
Blue triangle 	The following information related to interrupts <ul style="list-style-type: none"> - Time taken to generate an interrupt (unit: ms)
Blue inverted triangle 	The following information related to interrupts <ul style="list-style-type: none"> - Time taken to finish interrupt handler processing (unit: ms)
Light-blue/green line 	The following information related to object access status <ul style="list-style-type: none"> - Time taken to issue a service call (unit: ms) - Time taken to return from a service call (unit: ms) - Name of processing program that issued a service call - Service call name - Name of object subject to manipulation by service call
Red × mark 	The following information related to service calls <ul style="list-style-type: none"> - Time taken to return from a service call (unit: ms) - Value returned from service call

(o) Time area

This area displays the guide for generation interval of events displayed in the execution transition map. The display unit is shown at the right end of this area.

Remark In [Equal mode](#), this area displays the guide for the number of events displayed in the execution transition map.

(p) Dump to beginning button

This button moves the [Up cursor](#) to the top of trace data.

(q) Dump to end button

This button moves the [Down cursor](#) to the end of trace data.

[Object button display format]

Object buttons are displayed as explained below.

A too-long object name is abbreviated, but its real name pops up if the relevant button is pointed to by the mouse pointer.

Object Button	Meaning
Interrupt	Interrupt handler The button name is fixed to "Interrupt".
Task name	Task Task name defined in system configuration file.
Tsk (????)	Unknown processing program If execution of starts in the middle of a processing program, the performance analyzer cannot identify whether the processing program is an interrupt handler, task, or idle routine. The performance analyzer therefore handles the processing program as an unknown processing program.
Idle	Idle routine The button name is fixed to "Idle".
Semaphore name	Semaphore Semaphore name defined in system configuration file.
Eventflag name	Eventflag Eventflag name defined in system configuration file.
Mailbox name	Mailbox Mailbox name defined in system configuration file.
Fixed-sized memory pool name	Fixed-sized memory pool Fixed-sized memory pool name defined in system configuration file.
Etc.	Object hidden by right-clicking the object button

(1) Object button display order

The object button display order can be changed by clicking a [Sort buttons](#), or by dragging the corresponding object button.

(2) Hiding object buttons

Object buttons can be hidden by right-clicking the button corresponding to the object.

[How to read execution transition map]

The three types of basic display modes: [Simple mode](#), [Standard mode](#) and [Detail mode](#), are available for displaying the execution transition map. In addition to them, the [Equal mode](#) can be specified for each basic mode.





These modes can be selected by selecting the [View] menu >> [View mode].

(1) Simple mode

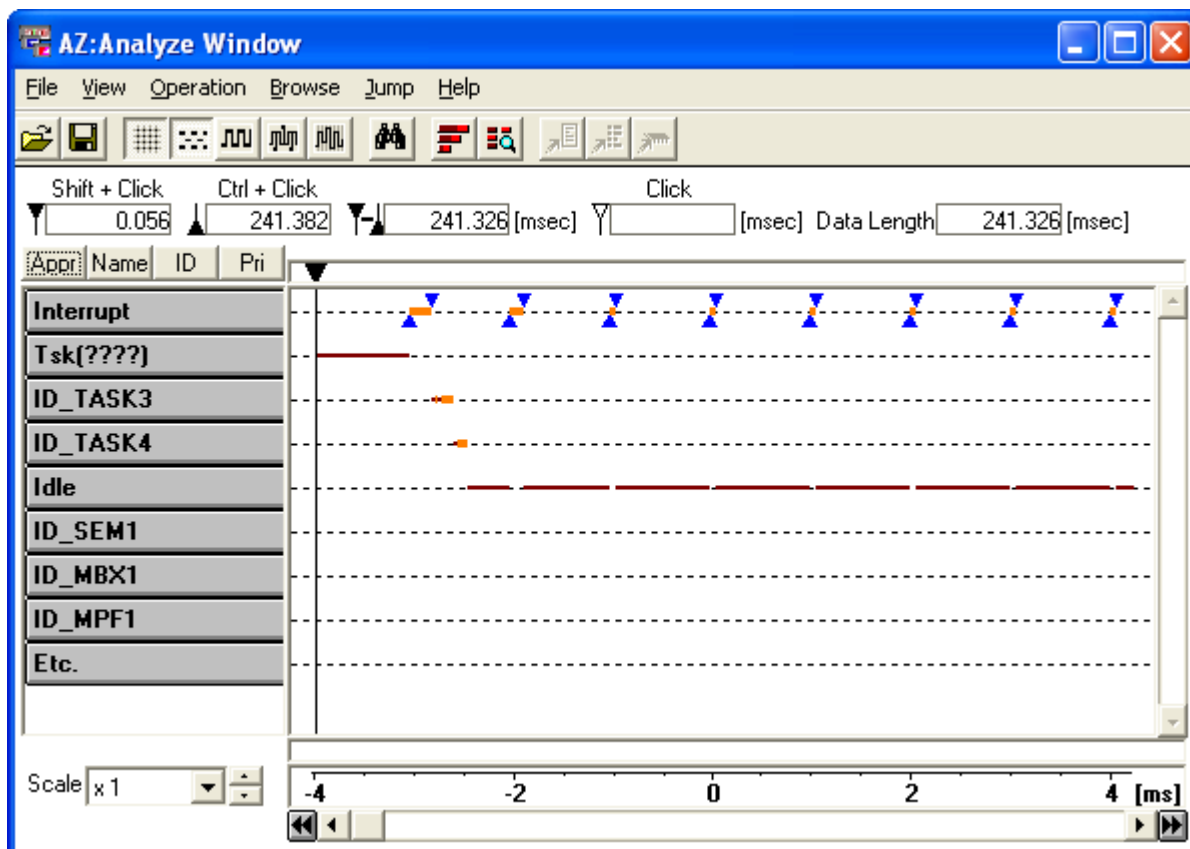
Displays the CPU usage with horizontal lines.

Figure A-7. Simple Mode (AZ:Analyze Window)







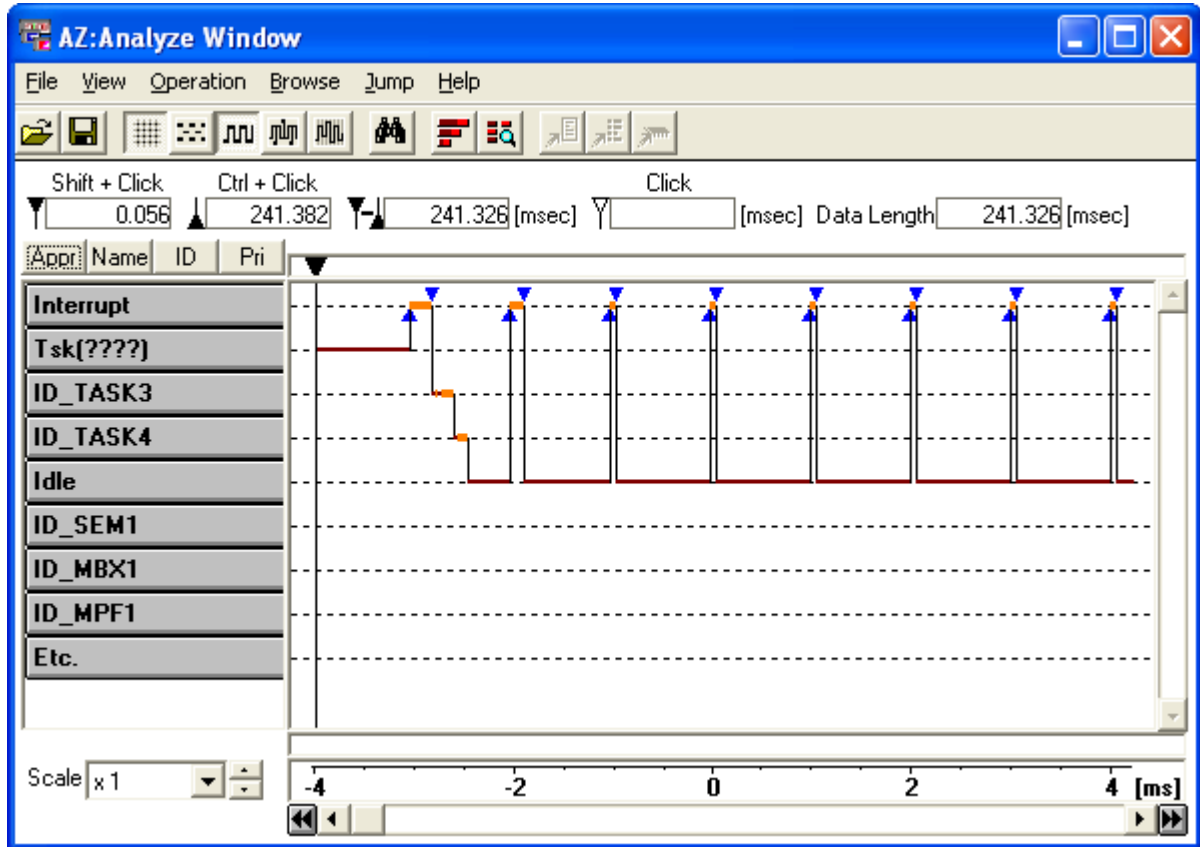

Mark	Meaning
Brown horizontal line 	Task or idle routine
Orange horizontal line 	Interrupt handler or RI78V4 internal processing
Bule tiangle 	Start of interrupt handler processing
Bule inverted triangle 	End of interrupt handler processing

(2) Standard mode

Displays the processing program switching status, with vertical lines being combined with information displayed in the Simple mode.

Figure A-8. Standard Mode (AZ:Analyze Window)









Mark	Meaning
Brown horizontal line 	Task or idle routine
Orange horizontal line 	Interrupt handler or RI78V4 internal processing
Bule tiangle 	Start of interrupt handler processing
Bule inverted triangle 	End of interrupt handler processing
Black vertical line 	Processing program switching status

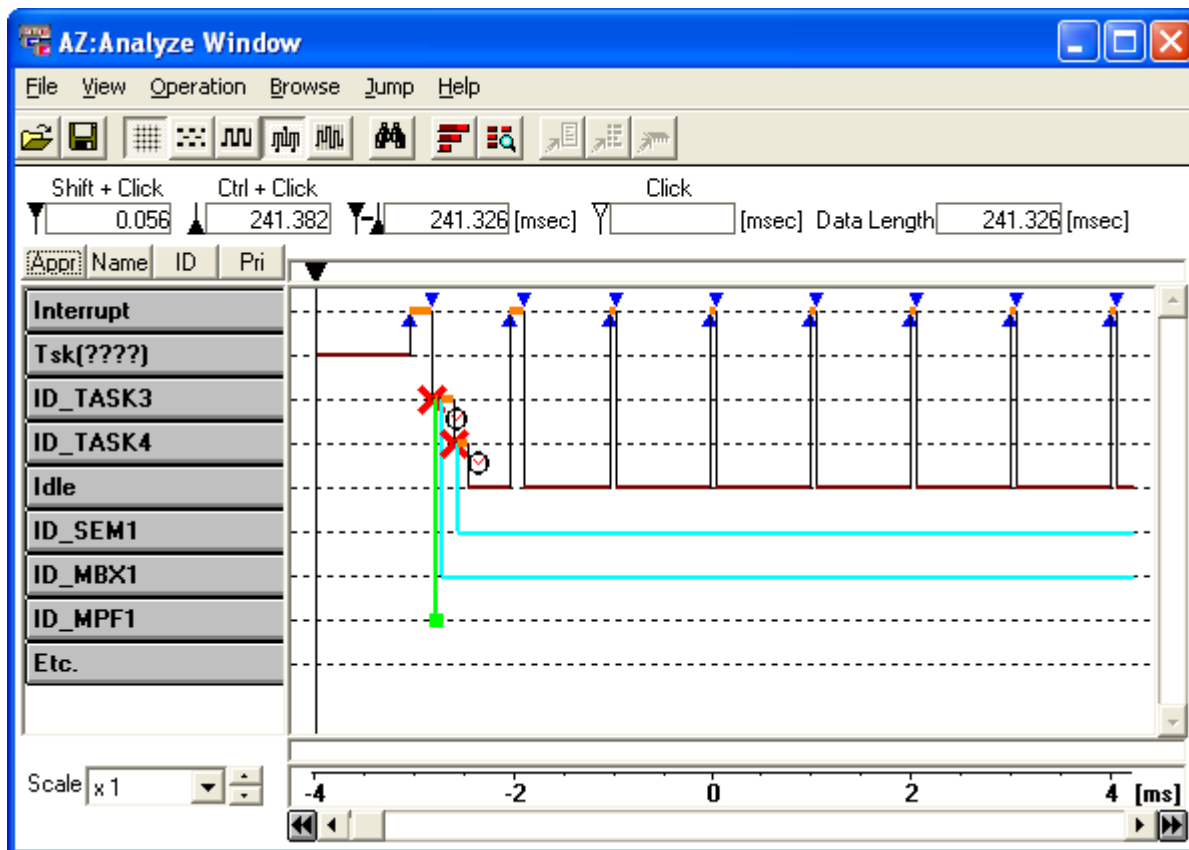



(3) Detail mode

Displays the service call issuance status, in addition to information displayed in the Standard mode.

Figure A-9. Detail Mode (AZ:Analyze Window)



Mark	Meaning
Brown horizontal line 	Task or idle routine
Orange horizontal line 	Interrupt handler or RI78V4 internal processing
Blue triangle 	Start of interrupt handler processing
Blue inverted triangle 	End of interrupt handler processing
Black vertical line 	Processing program switching status

<p>Light-blue line</p> 	<p>[If a semaphore is subject to manipulation]</p> <ul style="list-style-type: none"> - Issuance of wai_sem, pol_sem or twai_sem <p>[If an eventflag is subject to manipulation]</p> <ul style="list-style-type: none"> - Issuance of wai_flg, pol_flg or twai_flg <p>[If a mailbox is subject to manipulation]</p> <ul style="list-style-type: none"> - Issuance of rcv_mbx, prcv_mbx or trcv_mbx <p>[If a fixed-sized memory pool is subject to manipulation]</p> <ul style="list-style-type: none"> - Issuance of get_mpf, pget_mpf or tget_mpf
<p>Green line</p> 	<p>[If a semaphore is subject to manipulation]</p> <ul style="list-style-type: none"> - Issuance of sig_sem or isig_sem <p>[If an eventflag is subject to manipulation]</p> <ul style="list-style-type: none"> - Issuance of set_flg or iset_flg/clr_flg <p>[If a mailbox is subject to manipulation]</p> <ul style="list-style-type: none"> - Issuance of snd_mbx <p>[If a fixed-sized memory pool is subject to manipulation]</p> <ul style="list-style-type: none"> - Issuance of rel_mpf
<p>Red × mark</p> 	<p>A service call abnormally ended</p>
<p>Timeout mark</p> 	<p>A service call timed out</p>

Remark If a service call that moves to the WAITING state is issued in an [Unknown processing program](#), "Tsk (???)", the performance analyzer cannot recognize the WAITING state being released. The light-blue horizontal lines will therefore be drawn up to the end of the trace data counting.

(4) Equal mode

In the default state (in which the Equal mode is not specified), the brown/orange horizontal lines that show the CPU usage are displayed in proportion to the execution time taken by each processing program (see Figure A-10.).

Figure A-10. When Equal Mode Is Not Specified (AZ:Analyze Window)

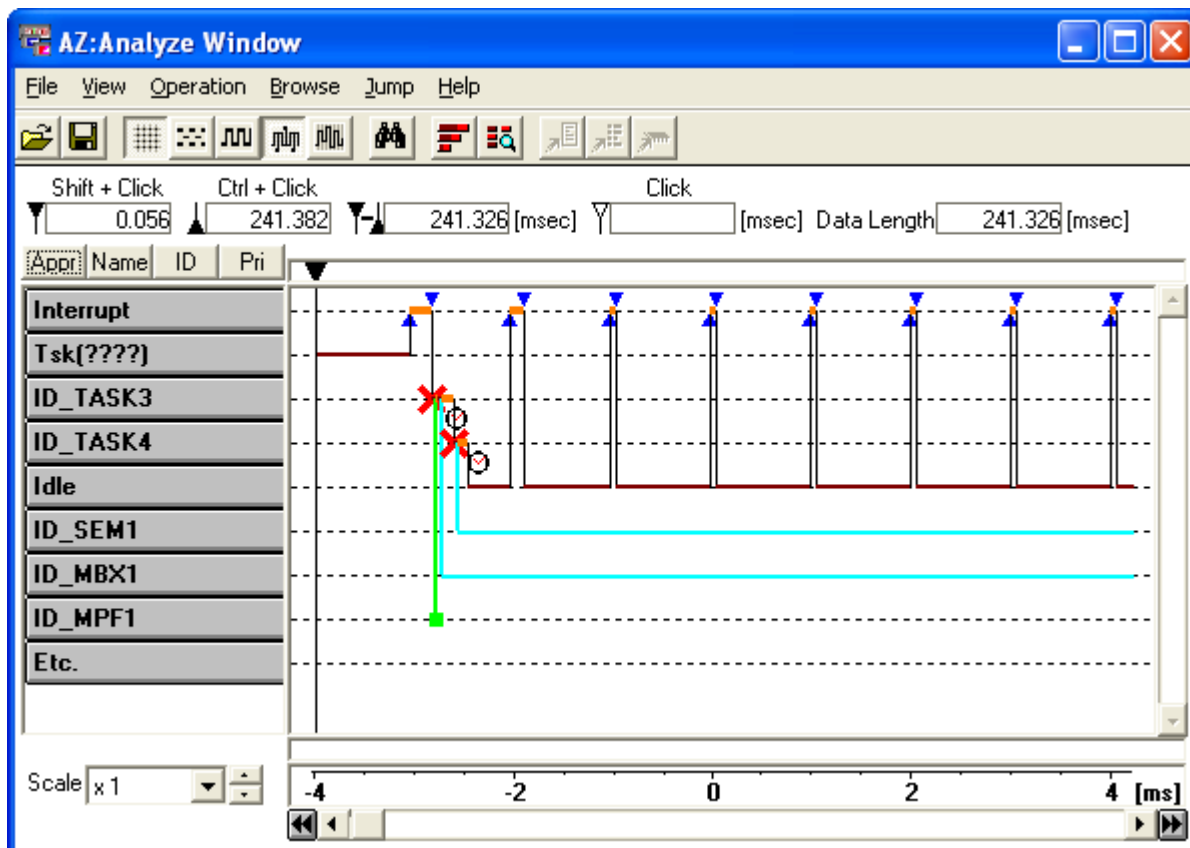

In the state in which the Equal mode is specified, in contrast, the brown/orange horizontal lines that show the CPU usage are displayed with a fixed length (see Figure A-11.).
 The horizontal lines between events such as task switching are also displayed in a fixed interval, not proportional to the CPU processing time.

Figure A-11. When Equal Mode Is Specified (AZ:Analyze Window)

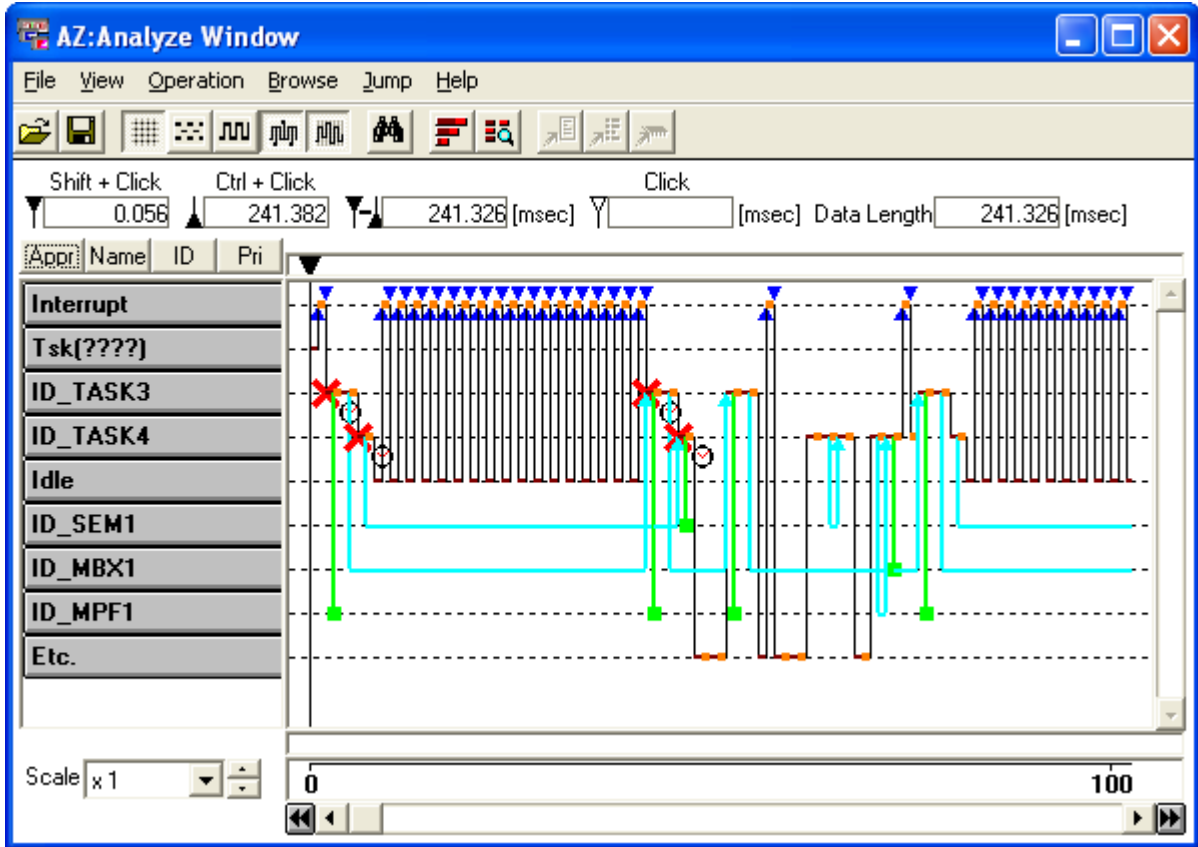

[How to verify execution transition map]

The execution transition map displayed in this window can be verified using either of the following two methods.

(1) Searching using Simple search buttons

The simple search buttons () can be used for searching for the location where an event related to the specified object occurred.

The following explains the procedure for searching event occurrence location, by using simple search buttons.

(a) Specification of search start point

Move the [Up temporary cursor](#) to the search start point.

If the [Up temporary cursor](#) is not displayed, move the [Up cursor](#) to the search start point.

(b) Displaying simple search buttons

Click the [Object buttons](#) corresponding to the object subject to search, to display the simple search buttons.

(c) Clicking simple search buttons

- When the  is clicked

The point at which an event related to the object selected in (b) occurred is searched for, from the search start point toward the reverse direction to the time axis, and the detected point is shown by the [Up temporary cursor](#).

A beep is generated if no events have occurred at any location.

- When the  is clicked

The point at which an event related to the object selected in (b) occurred is searched for, from the search start point toward the time axis direction, and the detected point is shown by the [Up temporary cursor](#).

A beep is generated if no events have occurred at any location.

(2) Searching in Pattern Search dialog box

The point at which a specific event occurred can be searched for in the [Pattern Search dialog box](#).

Refer to "[How to search]" for searching for the point at which a specific event occurred, in the [Pattern Search dialog box](#).

Pattern Search dialog box

Searches for the point at which a specific event occurred, based on the execution transition map displayed in the [AZ:Analyze window](#).

Figure A-12. Pattern Search Dialog Box

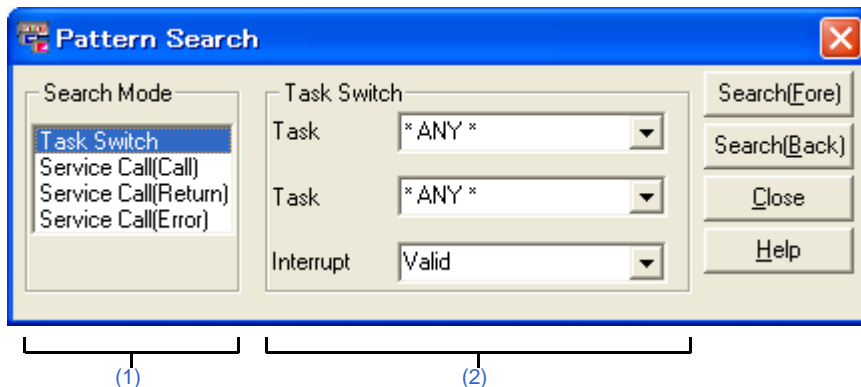

The following items are explained here.

- [\[How to open\]](#)
- [\[Description of each area\]](#)
- [\[Function buttons\]](#)
- [\[How to search\]](#)

[How to open]

- In the menubar of the [AZ:Analyze window](#), select [Find...] from the [View] menu.
- In the toolbar of the [AZ:Analyze window](#), click the button.
- In the [AZ:Analyze window](#), press the [Alt], [V] and [F] keys in that order.
- In the [AZ:Analyze window](#), press the [Ctrl] + [F] keys at the same time.

[Description of each area]

(1) [Search Mode] area

This area is used to select a event to be searched for (the type of an event to be searched for from the execution transition map displayed in the [AZ:Analyze window](#)) as search mode.

The following items can be selected as the search mode.

Select Mode	Meaning
Task Switch	Switching of processing programs
Service Call (Call)	Issuance of service call
Service Call (Return)	Returning from a service call
Service Call (Error)	Errors returned from a service call

(2) Search condition setting area

This area is used to select the conditions for searching for the selected search mode.

The items displayed in this area vary depending on the selected search mode.

- When "Task Switch" is selected

Item	Meaning
Task (upper)	Select a processing program before switching. Select [<i>name of the target task</i>] for task switching, [Interrupt] for interrupt handler switching, or [* ANY *] for any processing program switching.
Task (lower)	Select a processing program after switching. Select [<i>name of the target task</i>] for task switching, [Interrupt] for interrupt handler switching, or [* ANY *] for any processing program switching.
Interrupt	If [* ANY *] is selected for Task (upper) or Task (lower), select whether to include the location where switching to/from an interrupt handler occurred, into the search targets. Select [Valid] to include the location, or [Invalid] not to include the location.

Remark The search target varies depending on which of the items, [Valid] and [Invalid], is selected in the Interrupt list, as shown below.

The following figure assumes that switching from a "processing program [* ANY *]" to "processing program [Task2]" is included into the search targets.

Figure A-13. Difference in Search Targets

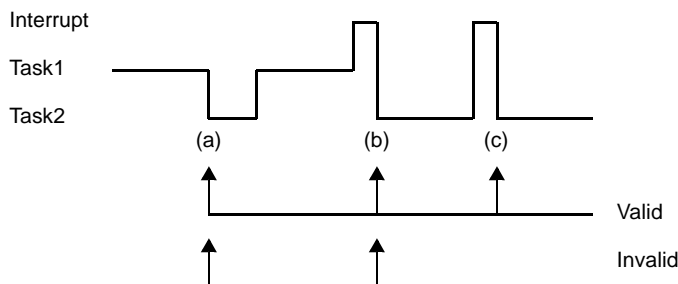

- Switching point (a)

Valid	Switching from [Task1] to [Task2] is included into the search targets.
Invalid	Switching from [Task1] to [Task2] is included into the search targets.

- Switching point (b)

Valid	Switching from [Interrupt] to [Task2] is included into the search targets.
Invalid	Switching from [Interrupt] to [Task2] is ignored, and switching from [Task1] to [Task2] is included into the search targets.

- Switching point (c)

Valid	Switching from [Interrupt] to [Task2] is included into the search targets.
Invalid	Switching from [Interrupt] to [Task2] is ignored, and switching from [Task1] to [Task2] is included into the search targets.

- When "Service Call (xxx)" is selected

Item	Meaning
Task	Select the processing program that issued the service call. Select [<i>name of the target task</i>] for task switching, [Interrupt] for interrupt handler switching, or [* ANY *] for any processing program switching.
Service Call	Select the service call name. Select [* ANY *] for any service call.
Object	Select the name of an object subject to manipulation by the service call. Select [* ANY *] for any object.

[Function buttons]

Button	Function
Search(Fore)	Searches for the locations that match the conditions selected in this dialog box, from the search start point toward the time axis direction. The up temporary cursor in the AZ:Analyze window shows the locations that match the specified conditions. A beep is generated if no locations match the specified conditions.
Search(Back)	Searches for the locations that match the conditions selected in this dialog box, from the search start point toward the reverse direction to the time axis. The up temporary cursor in the AZ:Analyze window shows the locations that match the specified conditions. A beep is generated if no locations match the specified conditions.
Close	Closes this dialog box. The function of this item is same as that of the  button.
Help	Displays the help window for this dialog box.

[How to search]

Using the following procedure, the point at which a specific event occurred to be searched for, based on the execution transition map displayed in the [AZ:Analyze window](#).

(1) Specification of search start point

Move the up temporary cursor to the search start point in the [AZ:Analyze window](#).

If the up temporary cursor is not displayed, move the up cursor to the search start point.

(2) How to open this dialog box

Select the [View] menu >> [Find...] in the [AZ:Analyze window](#).

(3) Selection of search mode and search conditions

Select the search mode and search conditions in the [\[Search Mode\] area](#) and [Search condition setting area](#) in this dialog box.

(4) Clacking function buttons

- When the [Search (Fore)] button is clicked

Points that match the conditions selected in this dialog box are searched for from the search start point toward the time axis direction, the up temporary cursor in the [AZ:Analyze window](#) shows the locations that match the specified conditions.

- When the [Search (Back)] button is clicked

Points that match the conditions selected in this dialog box are searched for from the search start point toward the reverse direction to the time axis. The up temporary cursor in the [AZ:Analyze window](#) shows the locations that match the specified conditions.

A beep is generated if no locations match the specified conditions.

AZ:Cpu window

Displays the CPU usage in a section between the up cursor and down cursor in the [AZ:Analyze window](#).

Figure A-14. AZ:Cpu Window

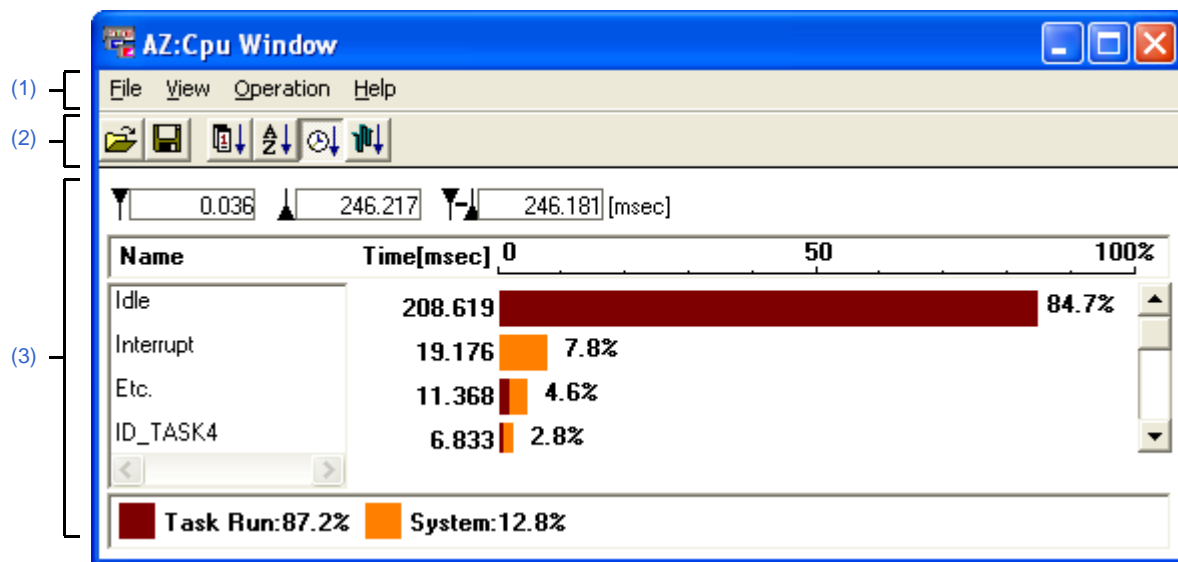

The following items are explained here.

- [\[How to open\]](#)
- [\[Description of each area\]](#)
- [\[Count method\]](#)

[How to open]

- In the menubar of the [AZ:Analyze window](#), select [CPU...] from the [Browse] menu.
- In the toolbar of the [AZ:Analyze window](#), click the  button.
- In the [AZ:Analyze window](#), press the [Alt], [B] and [C] keys in that order.
- In the [AZ:Analyze window](#), press the [Ctrl] + [C] keys at the same time.

Remark Closing the [AZ:Analyze window](#) also closes this window.



[Description of each area]

(1) Menubar





This bar consists of the following menu items.

(a) [File] menu

Open...	<p>Opens the Open/Save As dialog box.</p> <p>Loads the file that contains information to be displayed in this window (extension: .AZC).</p> <p>The function of this item is same as that of the  button.</p>
---------	---

Save...	<p>Opens the Open/Save As dialog box.</p> <p>Specifies the name of the file into which information displayed in this window is saved (extension: .AZC).</p> <p>The function of this item is same as that of the  button.</p>
Close	<p>Closes this window.</p> <p>The function of this item is same as that of the  button.</p>

(b) [View] menu

Sort Appear	<p>Displays the bar graphs in the order of detection in trace data.</p> <p>The function of this item is same as that of the  button.</p>
Sort Name	<p>Displays the bar graphs in the alphabetical order of the processing program names.</p> <p>The function of this item is same as that of the  button.</p>
Sort Time	<p>Displays the bar graphs in the order of longer total execution time (default).</p> <p>The function of this item is same as that of the  button.</p>
Sort Analyze	<p>Displays the bar graphs in the same order as those displayed in the execution transition map.</p> <p>The function of this item is same as that of the  button.</p>

(c) [Operation] menu





Active	<p>Switches this window to the Active mode.</p> <p>This window is in the Active mode when opened.</p>
Hold	<p>Switches this window to the Hold mode.</p>



(d) [Help] menu

This Window	<p>Displays the help window for this window.</p>
Help Topics	<p>Opens the online help, with the [Search] tab displayed.</p>

(2) Toolbar

This bar consists of the following buttons.

	<p>Opens the Open/Save As dialog box.</p> <p>Loads the file that contains information to be displayed in this window (extension: .AZC).</p> <p>The function of this item is the same as that of [Open...] int the [File] menu.</p>
	<p>Opens the Open/Save As dialog box.</p> <p>Specifies the name of the file into which information displayed in this window is saved (extension: .AZC).</p> <p>The function of this item is the same as that of [Save...] int the [File] menu.</p>
	<p>Displays the bar graphs in the order of detection in trace data.</p> <p>The function of this item is the same as that of [Sort Appear] int the [View] menu.</p>
	<p>Displays the bar graphs in the alphabetical order of the processing program names.</p> <p>The function of this item is the same as that of [Sort Name] int the [View] menu.</p>

	Displays the bar graphs in the order of longer total execution time (default). The function of this item is the same as that of [Sort Time] int the [View] menu.
	Displays the bar graphs in the same order as those displayed in the execution transition map. The function of this item is the same as that of [Sort Analyze] int the [View] menu.

(3) Information area

This area consists of the following informations.

Figure A-15. Information Area (AZ:Cpu Window)

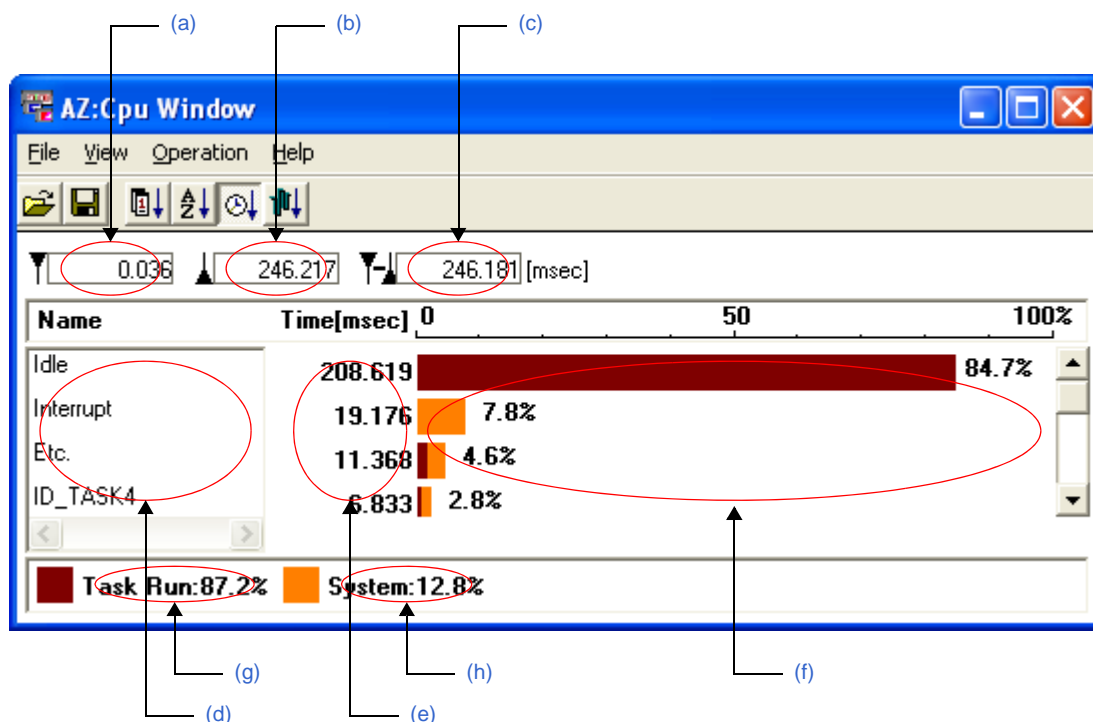

(a) Time up to count start point

This area displays the time up to the CPU usage counting start point.

The time up to the count start point is a relative time from when trace processing starts until the execution reaches the up cursor position (unit: ms).

(b) Time up to count end point

This area displays the time up to the CPU usage counting end point.

The time up to the count end point is a relative time from when trace processing starts until the execution reaches the down cursor position (unit: ms).

(c) Total time

This area displays the total time of the CPU usage.

The total time is a relative time indicated from the up cursor position to the down cursor position (unit: ms).

(d) Processing program name

This area lists the processing programs executed within the total time.

The following types of processing programs are displayed.

Processing Program Name	Meaning
Task name	Task
Interrupt	Interrupt handler
Idle	Idle routine

(e) Total execution time of processing program

This area displays the total execution time of the processing program within the total time (unit: ms).

(f) CPU usage

This area displays the bar graphs for indicating the percentage of the total time occupied by the execution time of processing programs.

The bar graphs distinguish user processing and system processing with different colors.

Color	Meaning
Brown	User processing (task, idle routine)
Orange	System processing (interrupt handler, RI78V4 internal processing)

Remark Service calls issued in a task or interrupt handler are handled as the RI78V4 internal processing.

(g) User processing code coverage

This area displays the percentage of the total time occupied by the user processing (task, idle routine) execution time.

(h) System processing code coverage

This area displays the percentage of the total time occupied by the system processing (interrupt handler, RI78V4 internal processing) execution time.

[Count method]

Using the following procedure, the CPU usage in a section between the up cursor and down cursor in the [AZ:Analyze window](#) can be checked.

(1) Specification of count start point

Move the up cursor to the count start position in the [AZ:Analyze window](#).

(2) Specification of count end point

Move the down cursor to the count end position in the [AZ:Analyze window](#).

(3) How to open this window

On the [AZ:Analyze window](#), select [CPU...] from the [Browse] menu.

When this window is opened, information corresponding to the count section specified in (1) and (2) is displayed.

Remark When this window is in the Active mode, information displayed in this window is also updated automatically along with moving of the up/down cursor in the [AZ:Analyze window](#) and information corresponding to the move destination of the up/down cursor is displayed.

AZ:Trace View window

Lists information obtained from the execution transition map in the [AZ:Analyze window](#).

Figure A-16. AZ:Trace View Window

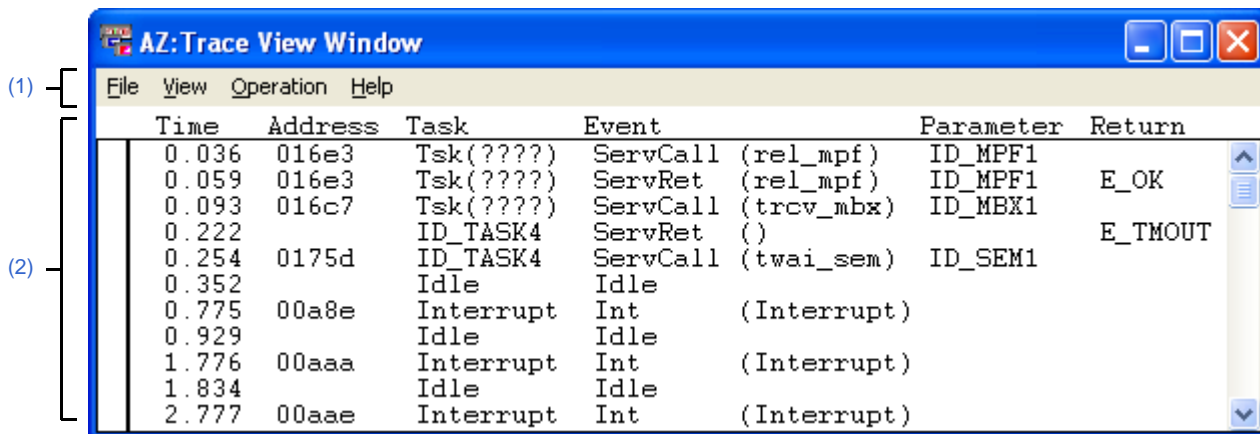

The following items are explained here.

- [\[How to open\]](#)
- [\[Description of each area\]](#)
- [\[How to display\]](#)
- [\[How to read the list\]](#)
- [\[Caution\]](#)

[How to open]

- In the menubar of the [AZ:Analyze window](#), select [Trace View...] from the [Browse] menu.
- In the toolbar of the [AZ:Analyze window](#), click the  button.
- In the [AZ:Analyze window](#), press the [Alt], [B] and [T] keys in that order.
- In the [AZ:Analyze window](#), press the [Ctrl] + [T] keys at the same time.

Remark Closing the [AZ:Analyze window](#) also closes this window.

[Description of each area]

(1) Menubar

This bar consists of the following menu items.

(a) [File] menu

Save...	Opens the Open/Save As dialog box . Specifies the name of the file into which information displayed in this window is saved (extension: .AZT).
Close	Closes this window. The function of this item is same as that of the  button.

(b) [View] menu

Find...	Opens the Trace Search dialog box . Searches for specific information (trace data) based on the list displayed in this window. This menu is unavailable when this window is in the Hold mode.
Time	Selects [Show] or [Hide] of the [Time] area (default: Show).
Address	Selects [Show] or [Hide] of the [Address] area (default: Show).
Task	Selects [Show] or [Hide] of the [Task] area (default: Show).
Event	Selects [Show] or [Hide] of the [Event] area (default: Show).
Parameter	Selects [Show] or [Hide] of the [Parameter] area (default: Show).
Return	Selects [Show] or [Hide] of the [Return] area (default: Show).

(c) [Operation] menu

Active	Switches this window to the Active mode. This window is in the Active mode when opened.
Hold	Switches this window to the Hold mode.

(d) [Help] menu

This Window	Displays the help window for this window.
Help Topics	Opens the online help, with the [Search] tab displayed.

(2) Information area

This area consists of the following informations.

(a) [Time] area

This area displays a relative time from when trace processing starts until the target event occurs (unit: ms).

(b) [Address] area

This area displays the execution address at which the target event occurred.

(c) [Task] area

This area displays the name of the processing program in which the target event occurred.

The following types of processing programs are displayed.

Processing Program Name	Meaning
Task name	Issuance of service call, returning from a service call, start of task processing
Interrupt	Issuance of service call, returning from a service call, start of interrupt handler processing, end of interrupt handler processing
Idle	Start of idle routine processing

(d) [Event] area

This area displays the types of the target events.

The following types of events are displayed.

Event Name	Meaning
ServCall (xxx_xxx)	Issuance of service call "xxx_xxx" xxx_xxx is displayed a service call name.
ServRet (xxx_xxx)	Returning from a service call "xxx_xxx" xxx_xxx is displayed a service call name. The inside of the parentheses is left blank if the event that issued the service call does not exist in the trace memory.
Int (Interrupt)	Start of interrupt handler processing
IntRet	End of interrupt handler processing
TaskStart	Start of task processing
Idle	Start of idle routine processing

(e) [Parameter] area

If the event type is "ServCall(xxx_xxx)" or "ServRet(xxx_xxx)", this area displays the name of the object to be manipulated by the service call (such as task name, semaphore name, or eventflag name).

(f) [Return] area

If the event type is "ServRet(xxx_xxx)", this area displays the values returned from the service call.

[How to display]

Using the following procedure, information obtained from the execution transition map displayed in the [AZ:Analyze window](#) can be listed.

(1) Specification of display start position

Move the up temporary cursor to the display start position in the [AZ:Analyze window](#).

If the up temporary cursor is not displayed, the display start position is the top of the trace data.

(2) How to open this window

Select the [Browse] menu >> [Trace View...] in the [AZ:Analyze window](#).

When this window is opened, information corresponding to the display start point specified in (1) is displayed in the first line.

Remark When this window is in the Active mode, information displayed in this window is also updated automatically along with moving of the up/down cursor in the [AZ:Analyze window](#), and information corresponding to the move destination of the up/down cursor is displayed in the first line.

[How to read the list]

The following explains how to read the list displayed in this window, using [Figure A-17](#). as an example.

The execution address in the above (1) and (2) means the address at which the relevant service call was issued.

Figure A-17. How to Read the List

	Time	Address	Task	Event	Parameter	Return
(1)	0.036	016e3	Tsk(????)	ServCall (rel_mpf)	ID_MPF1	
(2)	0.059	016e3	Tsk(????)	ServRet (rel_mpf)	ID_MPF1	E_OK
	0.093	016c7	Tsk(????)	ServCall (trcv_mbx)	ID_MBX1	
	0.222		ID_TASK4	ServRet ()		E_TMOU
	0.254	0175d	ID_TASK4	ServCall (twai_sem)	ID_SEM1	
	0.352		Idle	Idle		
	0.775	00a8e	Interrupt	Int (Interrupt)		
	0.929		Idle	Idle		
	1.776	00aaa	Interrupt	Int (Interrupt)		
	1.834		Idle	Idle		
	2.777	00aae	Interrupt	Int (Interrupt)		

(1) When 0.036 ms have elapsed after trace processing has started, processing program TSK (????) issues service call rel_mpf to fixed-sized memory pool ID_MPF1.

(2) When 0.059 ms have elapsed after trace processing has started, service call rel_mpf that was issued in (1) returns E_OK.

[Caution]

- If an interrupt occurs during idle routine processing, information related to "IntRet", which indicates the end of the interrupt handler processing, will not be displayed.

Trace Search dialog box

Searches for specific information (trace data) based on the list displayed in the [AZ:Trace View window](#).

Figure A-18. Trace Search Dialog Box

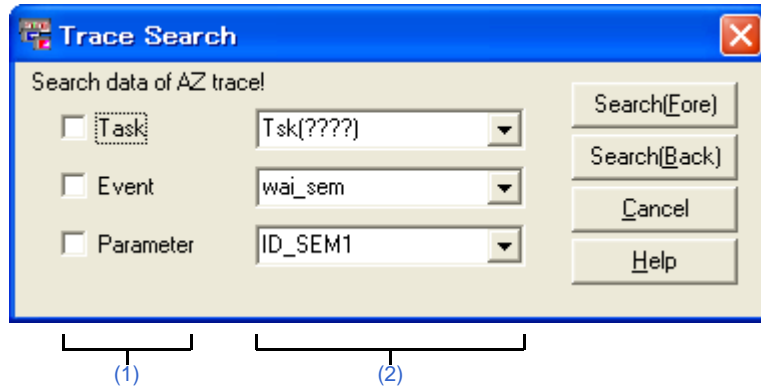

The following items are explained here.

- [\[How to open\]](#)
- [\[Description of each area\]](#)
- [\[Function buttons\]](#)
- [\[How to search\]](#)

[How to open]

- In the menubar of the [AZ:Trace View window](#), select [Find...] from the [View] menu.
- In the [AZ:Trace View window](#), press the [Alt], [V] and [F] keys in that order.
- In the [AZ:Trace View window](#), press the [Ctrl] + [F] keys at the same time.

[Description of each area]

(1) Searched item area

This area is used to specify the items to be searched for (from the list displayed in the [AZ:Trace View window](#)). Multiple items in the following table can be selected as the items to be searched for.

Task	Searches for information from the Task area in the list displayed in the AZ:Trace View window .
Event	Searches for information from the Event area in the list displayed in the AZ:Trace View window .
Parameter	Searches for information from the Parameter area in the list displayed in the AZ:Trace View window .

(2) Search condition area

This area is used to select the conditions for searching for items specified in the [Searched item area](#).

The following items can be selected as the search conditions.

- Processing program name (task name, Interrupt, Idle)
- Event type (service call name)

- Name of object subject to manipulation by service call such as task name, semaphore name, or eventflag name)

[Function buttons]

Button	Function
Search (Fore)	Searches for information that matches the conditions specified in this dialog box, from the older trace data. Condition match information is displayed in the first line of the AZ:Trace View window . A beep is generated if condition match information does not exist in the relevant list.
Search (Back)	Searches for information that matches the conditions specified in this dialog box, from the newer trace data. Condition match information is displayed in the first line of the AZ:Trace View window . A beep is generated if condition match information does not exist in the relevant list.
Cancel	Closes this dialog box. The function of this item is same as that of the  button.
Help	Displays the help window for this dialog box.

[How to search]

Using the following procedure, specific information can be searched for, based on the list displayed in the [AZ:Trace View window](#).

(1) Switching to Active mode

Select the [Operation] menu >> [Active] in the [AZ:Trace View window](#) to switch the target window to the Active mode.

(2) How to open this dialog box

On the [AZ:Trace View window](#), select [Find...] from the [View] menu.

(3) Specification of items to be searched for and search conditions

Specify the items to be searched for and search conditions in the searched item area and search condition area in this dialog box.

Figure A-19. Specification Example 1 (Search for Interrupt)

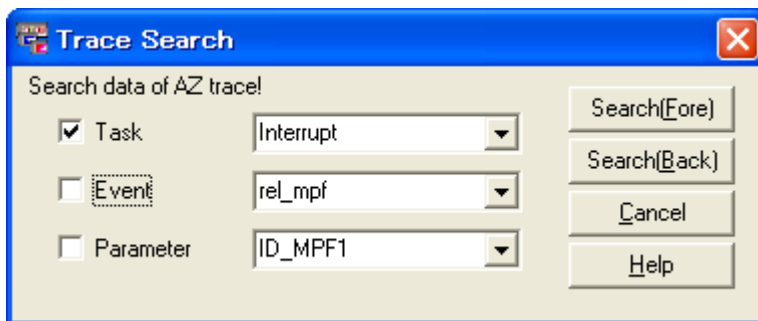

Figure A-20. Specification Example 1 (Search for Location at Which rel_mpf Was Issued)

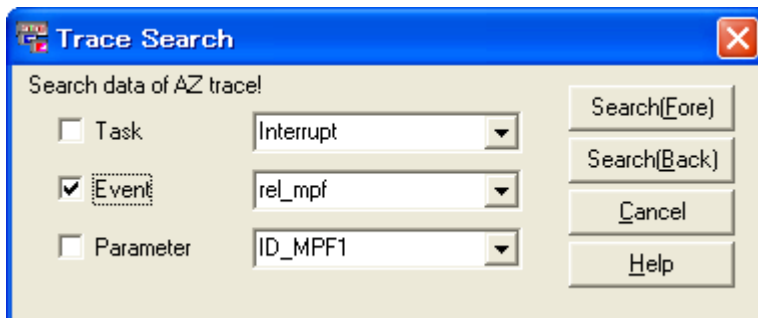
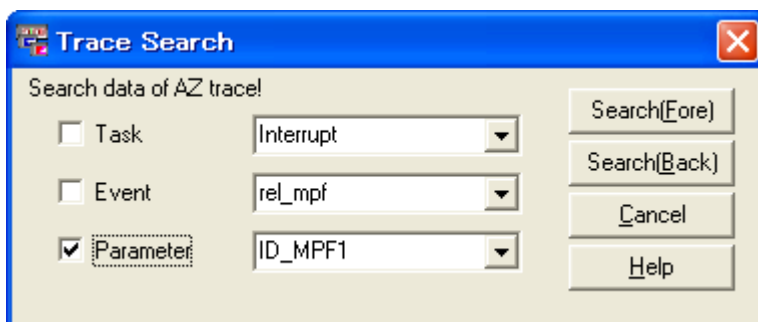

Figure A-21. Specification Example 1 (Search for Location at Which Searvice Call Was Issued for ID_MPF1)

**(4) Clicking function buttons**

- [Search (Fore)] button

Information that matches the conditions specified in this dialog box is searched for from the newer trace data, and condition match information is displayed in the first line of the [AZ:Trace View window](#).

A beep is generated if condition match information does not exist.

- [Search (Back)] button

Information that matches the conditions specified in this dialog box is searched for from the newer trace data, and condition match information is displayed in the first line of the [AZ:Trace View window](#).

A beep is generated if condition match information does not exist.

About dialog box

Displays the version information of the performance analyzer.

Figure A-22. About Dialog Box

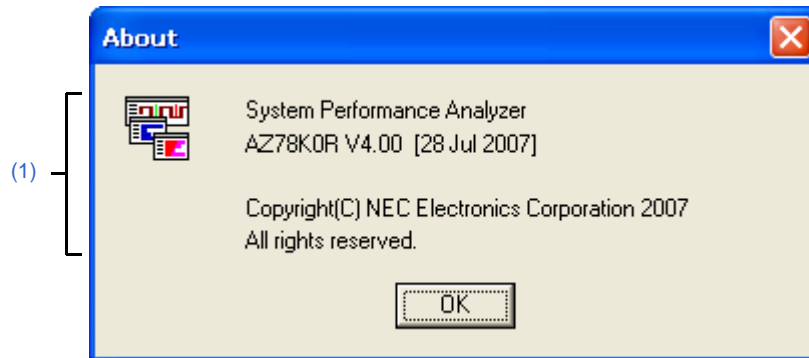

The following items are explained here.

- [How to open]
- [Description of each area]
- [Function buttons]

[How to open]

- In the menubar of the [AZ78K0R window](#), select [About...] from the [Help] menu.
- In the [AZ78K0R window](#), press the [Alt], [H] and [A] keys in that order.
- In the [AZ78K0R window](#), press the [Ctrl] + [A] keys at the same time.

[Description of each area]

(1) Version information area

This area is used to display "product name, version number, date of product build and copyright".

[Function buttons]

Button	Function
OK	Closes this dialog box. The function of this item is same as that of the button.

AZ:Error dialog box

Displays the error information of the performance analyzer.

Figure A-23. AZ:Error Dialog Box



The following items are explained here.

- [How to open]
- [Description of each area]
- [Function buttons]

[How to open]

This dialog box opens automatically when an invalid operation is performed in a window or a dialog box.

[Description of each area]

(1) Error information area

This area is used to display "error number and error message".
 For details of the error information, see "B.2 Error Messages".

[Function buttons]

Button	Function
OK	Closes this dialog box. The function of this item is same as that of the  button.
Help	Displays the help topic corresponding to error information.

APPENDIX B MESSAGES

This appendix provides the error information output from the performance analyzer.

B.1 Overview

If an error occurs during an operation in a window/dialog box, the following **AZ:Error** dialog box that displays the error information is displayed.

Figure B-1. Error Information Output Format

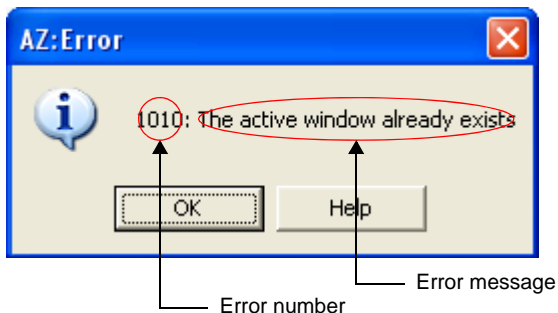

B.2 Error Messages

The performance analyzer error information is shown below.

Table B-1. Error Information List

Error Number	Description	
1000	Message	Not enough memory.
	Cause	The memory required for the performance analyzer operation is insufficient.
	Action by User	Close unnecessary application software and then restart the performance analyzer.
1001	Message	Internal error.
	Cause	An error has occurred in the performance analyzer internal processing.
	Action by User	Restart the performance analyzer.
1010	Message	The active window already exists.
	Cause	A window in the Active mode is open.
	Action by User	In the performance analyzer, multiple windows of the same type cannot be open in the Active mode at the same time. Implement either of the following measures. - Change the mode of the window from Active to Hold. - Close the window in the Active mode.
1021	Message	The file does not exist.
	Cause	No relevant files exist in the folder selected in the Open/Save As dialog box .
	Action by User	Specify an existing file.

Error Number	Description	
1022	Message	Fail to write the file.
	Cause	The memory for writing to the file is insufficient, or the file subject to write is write-prohibited.
	Action by User	Implement either of the following measures. <ul style="list-style-type: none"> - Delete unnecessary files. - Specify another partition for writing. - Change the attribute of the target file so as to enable writing. - Specify a write-enabled file as the file subject to write.
1023	Message	The file format is illegal.
	Cause	A file of an invalid format was selected in the Open/Save As dialog box .
	Action by User	In the performance analyzer, the format of loadable files varies depending on the window through which the Open/Save As dialog box is opened. AZ:Analyze window : Analyze File (*.AZ) AZ:Cpu window : CPU File (*.AZC)
1100	Message	The debugger does not support AZ interface.
	Cause	The CubeSuite+ does not support AZ Interface.
	Action by User	Confirm that the CubeSuite+ supports AZ Interface.
1110	Message	Fail to switch AZ trace mode.
	Cause	The performance analyzer failed communication with the CubeSuite+.
	Action by User	Restart the performance analyzer and CubeSuite+.
1120	Message	Fail to load the trace data.
	Cause	The performance analyzer failed communication with the CubeSuite+.
	Action by User	Restart the performance analyzer and CubeSuite+.
1121	Message	The trace data does not exist.
	Cause	No information that should be stored in the trace memory exists in the trace data collect section.
	Action by User	Expand the trace data collect section and retry collection of trace data.

APPENDIX C INDEX

A

About dialog box ... 56
AZ78K0R window ... 18
AZ:Analyze window ... 25
AZ:Cpu window ... 45
AZ:Error dialog box ... 57
AZ:Trace View window ... 49

D

debugging procedure ... 12

F

features ... 9
functions ... 10

H

hard trace form ... 10

M

messages ... 58

O

Open/Save As dialog box ... 22

P

Pattern Search dialog box ... 41
performance analyzer ... 9
 debugging procedure ... 12
 features ... 9
 functions ... 10
 messages ... 58
 trace data ... 10
 trace form ... 10
 window reference ... 17

T

trace data ... 10
trace form ... 10
 hard trace form ... 10

Trace Search dialog box ... 53

W

window reference ... 17
 About dialog box ... 56
 AZ78K0R window ... 18
 AZ:Analyze window ... 25
 AZ:Cpu window ... 45
 AZ:Trace View window ... 49
 Open/Save As dialog box ... 22
 Pattern Search dialog box ... 41
 Trace Search dialog box ... 53
 AZ:Error dialog box ... 57

Revision Record

Rev.	Date	Description	
		Page	Summary
1.00	Apr 01, 2011	-	First Edition issued

RI78V4

User's Manual: Analysis

Publication Date: Rev.1.00 Apr 01, 2011

Published by: Renesas Electronics Corporation

**SALES OFFICES****Renesas Electronics Corporation**<http://www.renesas.com>Refer to "<http://www.renesas.com/>" for the latest and detailed information.

Renesas Electronics America Inc.
2880 Scott Boulevard Santa Clara, CA 95050-2554, U.S.A.
Tel: +1-408-588-6000, Fax: +1-408-588-6130

Renesas Electronics Canada Limited
1101 Nicholson Road, Newmarket, Ontario L3Y 9C3, Canada
Tel: +1-905-898-5441, Fax: +1-905-898-3220

Renesas Electronics Europe Limited
Dukes Meadow, Millboard Road, Bourne End, Buckinghamshire, SL8 5FH, U.K
Tel: +44-1628-585-100, Fax: +44-1628-585-900

Renesas Electronics Europe GmbH
Arcadiastrasse 10, 40472 Düsseldorf, Germany
Tel: +49-211-65030, Fax: +49-211-6503-1327

Renesas Electronics (China) Co., Ltd.
7th Floor, Quantum Plaza, No.27 ZhiChunLu Haidian District, Beijing 100083, P.R.China
Tel: +86-10-8235-1155, Fax: +86-10-8235-7679

Renesas Electronics (Shanghai) Co., Ltd.
Unit 204, 205, AZIA Center, No.1233 Lujiazui Ring Rd., Pudong District, Shanghai 200120, China
Tel: +86-21-5877-1818, Fax: +86-21-6887-7858 / -7898

Renesas Electronics Hong Kong Limited
Unit 1601-1613, 16/F., Tower 2, Grand Century Place, 193 Prince Edward Road West, Mongkok, Kowloon, Hong Kong
Tel: +852-2886-9318, Fax: +852 2886-9022/9044

Renesas Electronics Taiwan Co., Ltd.
7F, No. 363 Fu Shing North Road Taipei, Taiwan
Tel: +886-2-8175-9600, Fax: +886 2-8175-9670

Renesas Electronics Singapore Pte. Ltd.
1 harbourFront Avenue, #06-10, keppel Bay Tower, Singapore 098632
Tel: +65-6213-0200, Fax: +65-6278-8001

Renesas Electronics Malaysia Sdn.Bhd.
Unit 906, Block B, Menara Amcorp, Amcorp Trade Centre, No. 18, Jln Persiaran Barat, 46050 Petaling Jaya, Selangor Darul Ehsan, Malaysia
Tel: +60-3-7955-9390, Fax: +60-3-7955-9510

Renesas Electronics Korea Co., Ltd.
11F., Samik Laviel'or Bldg., 720-2 Yeoksam-Dong, Kangnam-Ku, Seoul 135-080, Korea
Tel: +82-2-558-3737, Fax: +82-2-558-5141

RI78V4



Renesas Electronics Corporation

R20UT0513EJ0100