

RA Family

Vector control for permanent magnetic synchronous motor with hall sensors For Renesas Flexible Motor Control Series

Introduction

This application note describes the sample program for a permanent magnetic synchronous motor drive with vector control with hall sensors based on Renesas microcontroller. This application note also describes how to use the motor control development support tool, 'Renesas Motor Workbench'.

The targeted software for this application is only to be used as reference purposes and Renesas Electronics Corporation does not guarantee the operations. Please use this after carrying out a thorough evaluation in a suitable environment.

Target Device

Operations of the target software of this application note are checked by using the following device.

- RA6T2 (R7FA6T2BD3CFP)
- RA6T3 (R7FA6T3BB3CFM)
- RA4T1 (R7FA4T1BB3CFM)
- RA8T1 (R7FA8T1AHECBD)

Target Software

Target software of this application note is described below.

- RA6T2_MCILV1_SPM_HALL_FOC_E2S_V110
- RA4T1_MCILV1_SPM_HALL_FOC_E2S_V100
- RA6T3_MCILV1_SPM_HALL_FOC_E2S_V100
- RA8T1_MCILV1_SPM_HALL_FOC_E2S_V100

Contents

1. Overview.....	4
2. Development environment.....	4
2.1 Test environments.....	4
2.2 Hardware specifications.....	5
2.2.1 Hardware configuration diagram.....	5
2.2.2 User interface.....	6
2.2.3 Peripheral functions.....	8
2.2.3.1 RA6T2.....	8
2.2.3.2 RA4T1.....	15
2.2.3.3 RA6T3.....	18
2.2.3.4 RA8T1.....	21
2.3 Software configuration.....	24
2.3.1 Software file configuration.....	24
2.3.2 Module configuration.....	26
2.4 Software Specifications.....	27
2.5 Interrupt Priority.....	28
3. Descriptions of Control Program.....	29
3.1 Contents of Control.....	29
3.1.1 Motor start/stop.....	29
3.1.2 A/D converter.....	29
3.1.3 Modulation (current control module).....	30
3.1.3.1 Sine wave modulation (MOD_METHOD_SPWM).....	30
3.1.3.2 Space Vector Modulation (MOD_METHOD_SVPWM).....	30
3.1.4 State transition.....	31
3.1.5 Rotor angle and rotational speed estimation with hall sensors.....	32
3.1.5.1 Estimation of rotational speed.....	32
3.1.5.2 Estimation of rotor angle.....	33
3.1.6 Start-up method.....	36
3.1.7 System protection function.....	37
3.1.8 AD triggers.....	38
3.2 Function Specifications of Hall Sensor Vector Control Software.....	39
3.3 List of functions.....	40
3.4 Contents of Control.....	48
3.4.1 Configuration options.....	48
3.4.2 Configuration Options for included modules.....	48
3.5 Control flowcharts.....	57
3.5.1 Main process.....	57
3.5.2 Current Control Period Interrupt (carrier synchronized interrupt) process.....	58

3.5.3	Speed control Period interrupt process.....	59
3.5.4	Over current detection interrupt process.....	60
4.	Project Operation Overview.....	61
4.1	Quick Start.....	61
4.2	Motor Control Development Support Tool 'Renesas Motor Workbench'	62
4.2.1	Overview.....	62
4.2.2	Easy function operation example	63
4.2.3	List of variables for Analyzer function	65
4.2.4	Operation example for Analyzer.....	66
4.2.5	Tuner function	68
4.2.6	Example of changing communication speed.....	69
4.2.7	How to use the built-in communication library.....	70
5.	Reference Documents.....	73
	Revision History	74

1. Overview

This application note explains how to implement the vector control with hall sensors software that drives permanent magnetic synchronous motor (PMSM) using the microcontroller RA series. The sample program of this application note can drive a motor easily with the kit of motor control (Renesas Flexible Motor Control series). And the program also supports the tool of motor control development support 'Renesas Motor Workbench'. With the tool, you can confirm internal data of software and use as user interface. Please utilize to choose the MCU and develop software with reference of this sample program in setting of peripherals or measurement of period of interrupt process.

2. Development environment

2.1 Test environments

Table 2-1 and Table 2-2 show the development environment of the software explained in this application note,

Table 2-1 Hardware development environment

Category	Product used
Microcontroller / CPU board product type	RA6T2 (R7FA6T2BD3CFP) / RTK0EMA270C00000BJ RA4T1 (R7FA4T1BB3CFM) / RTK0EMA430C00000BJ RA6T3 (R7FA6T3BB3CFM) / RTK0EMA330C00000BJ RA8T1(R7FA8T1AHECBD) / RTK0EMA5K0C00000BJ
Inverter board	MCI-LV-1 / RTK0EM0000S04020BJ
Motor	R42BLD30L3 (product of MOONS)

Table 2-2 Software development environment

e2studio version	FSP version	Toolchain version
V2023-10	V5.1.0	GCC ARM Embedded: 10.3.1.20210824 (RA6T2,RA6T3,RA4T1) 13.2.1.arm-13-7 (RA8T1)

For purchase and technical support, contact Sales representatives and dealers of Renesas Electronics Corporation.

2.2 Hardware specifications

2.2.1 Hardware configuration diagram

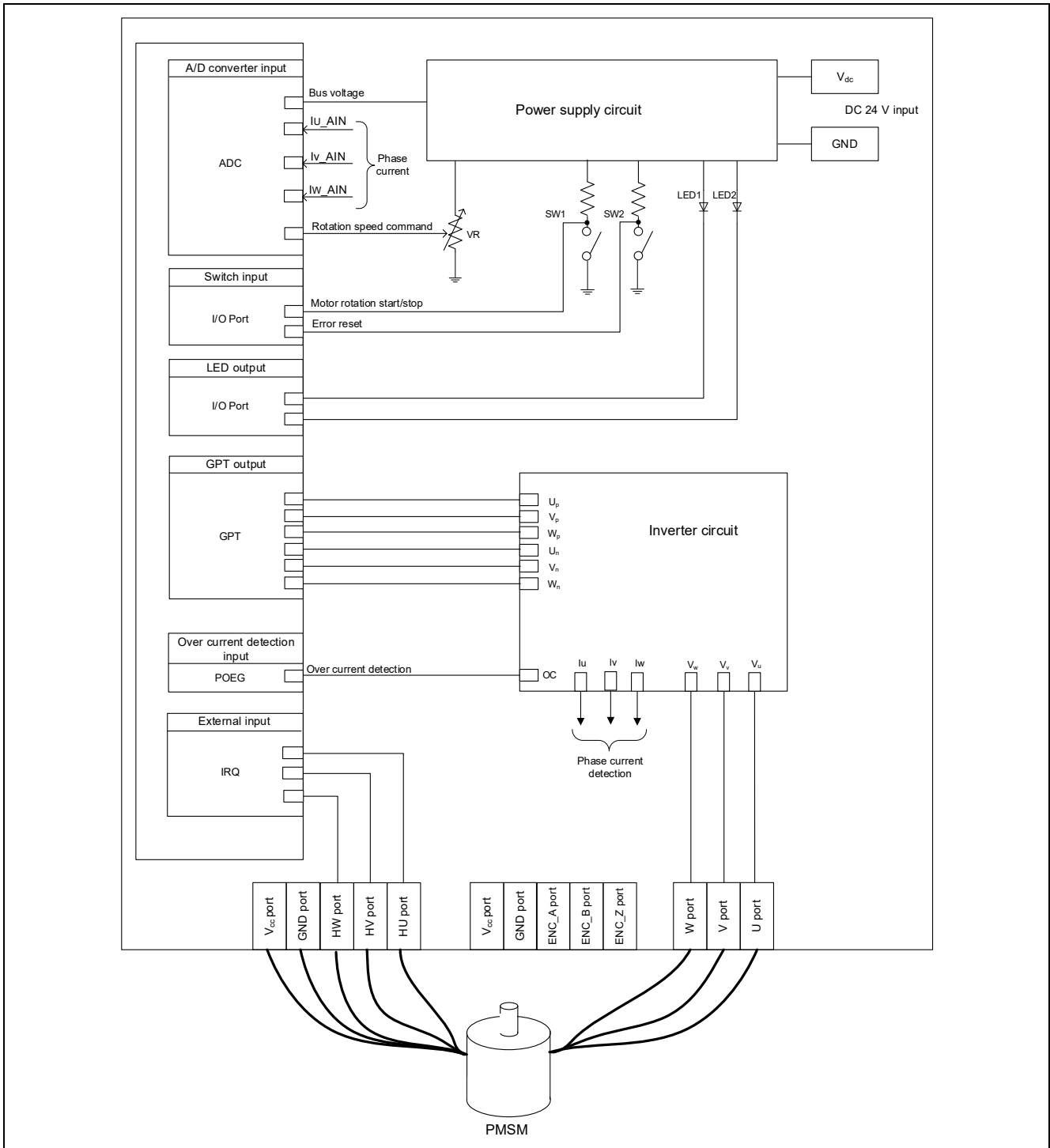

Figure 2-1 Hardware configuration diagram

2.2.2 User interface

Table 2-3 is the list of user interface of this system.

Table 2-3 User interfaces

Item	Interface component	Function
Rotation speed command	Variable resistor (VR1)	Input of rotational speed reference (analog value)
START / STOP	Toggle switch (SW1)	Motor rotation start/stop command
ERROR RESET	Push switch (SW2)	Command of recovery from error status
LED1	Orange LED (LED1)	<ul style="list-style-type: none"> At the time of Motor rotation: ON At the time of Motor stop: OFF
LED2	Orange LED (LED2)	<ul style="list-style-type: none"> At the time of error detection: ON At the time of normal operation: OFF

Table 2-4 are the lists of port interface of this system.

Table 2-4 Port interfaces

Function	RA6T2	RA4T1	RA6T3	RA8T1
Inverter bus voltage measurement	PA06 / AN006	P004 / AN004	P004 / AN004	P008 / AN008
For rotation speed command value input (VR1)	PB00 / AN008	P005 / AN005	P005 / AN005	P014 / AN007
START/STOP toggle switch (SW1)	PD04	P304	P304	PA15
ERROR RESET push switch (SW2)	PD07	P200	P200	PA13
LED1 ON/OFF control	PD01	P113	P113	PA12
LED2 ON/OFF control	PD02	P106	P106	PA14
U phase current measurement	PA04 / AN004	P000 / AN000	P000 / AN000	P004 / AN000
W phase current measurement	PA00 / AN000	P002 / AN002	P002 / AN002	P006 / AN002
PWM output (Up)	PB04 / GTIOC4A	P409 / GTIOC1A	P409 / GTIOC1A	P115 / GTIOC5A
PWM output (Vp)	PB06 / GTIOC5A	P103 / GTIOC2A	P103 / GTIOC2A	P113 / GTIOC2A
PWM output (Wp)	PB08 / GTIOC6A	P111 / GTIOC3A	P111 / GTIOC3A	P300 / GTIOC3A
PWM output (Un)	PB05 / GTIOC4B	P408 / GTIOC1B	P408 / GTIOC1B	P609 / GTIOC5B
PWM output (Vn)	PB07 / GTIOC5B	P102 / GTIOC2B	P102 / GTIOC2B	P114 / GTIOC2B
PWM output (Wn)	PB09 / GTIOC6B	P112 / GTIOC3B	P112 / GTIOC3B	P112 / GTIOC3B
U phase hall sensor input (HU)	PC04	P008 / IRQ12	P008 / IRQ12	P907 / IRQ10
V phase hall sensor input (HV)	PC05	P006 / IRQ11	P006 / IRQ11	P905 / IRQ8
W phase hall sensor input (HW)	PB01	P015 / IRQ13	P015 / IRQ13	P906 / IRQ9
PWM emergency stop input at the time of overcurrent detection	PC13 / GTETRGD	P104 / GTETRGB	P104 / GTETRGB	P613 / GTETRGA

List of port interfaces of the sensor.

Table 2-5 Port Interfaces

Function	MCI-LV-1
GND	CN6 1pin
+5V	CN6 2pin
Hall sensor input (HW)	CN6 3pin
Hall sensor input (HV)	CN6 4pin
Hall sensor input (HU)	CN6 5pin

2.2.3 Peripheral functions

List of the peripheral functions used in this system is given in Table 2-6.

Table 2-6 List of the peripheral functions

Peripheral	Purpose	RA6T2	RA4T1	RA6T3	RA8T1
A/D converter	U phase current measurement	AN004	AN000	AN000	AN000
	V phase current measurement	AN002	AN001	AN001	AN001
	W phase current measurement	AN000	AN002	AN002	AN002
	Inverter bus voltage measurement	AN006	AN004	AN004	AN008
	For rotation speed command value input (analog value)	AN008	AN005	AN005	AN007
AGT	Speed control interval timer	AGT0	AGT0	AGT0	AGT0
GPT	U phase PWM output	CH4	CH1	CH1	CH5
	V phase PWM output	CH5	CH2	CH2	CH2
	W phase PWM output	CH6	CH3	CH3	CH3
POEG	PWM emergency stop input at the time of overcurrent detection	Group D	Group B	Group B	Group A

2.2.3.1 RA6T2

(1) A/D Converter (ADC)

U-phase current, W-phase current, inverter bus voltage, and rotation speed command are measured in "Single Scan Mode" (use a hardware trigger). A/D conversion is implemented to be synchronized with carrier synchronized interrupt.

(2) Low Power Asynchronous General-Purpose Timer (AGT)

The AGT is used as 500 [μs] interval timer.

(3) General PWM Timer (GPT)

On the channel 4,5 and 6, output with dead time is performed by using the complementary PWM Output Operating Mode.

(4) Port Output Enable for GPT (POEG)

The port executing PWM output are set to high impedance state when an overcurrent is detected (when a low level of the GTETRGD port is detected).

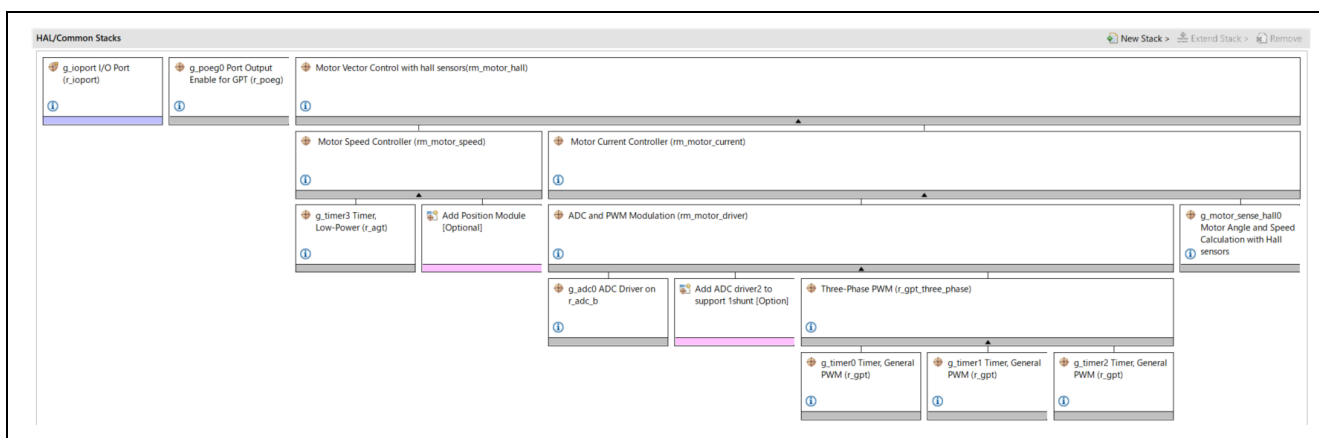

Figure 2-2 Overall FSP stacks diagram

g_adc0 ADC Driver on r_adc_b		
Settings	Property	Value
API Info	▼ Common	
	Parameter Checking	Default (BSP)
	▼ Module g_adc0 ADC Driver on r_adc_b	
	▼ General	
	▼ Operation	
	▼ ADC 0	
	Conversion Method	SAR Mode
	Scan Mode	Single Scan
	▼ ADC 1	
	Conversion Method	SAR Mode
	Scan Mode	Single Scan
	▼ ADC Successive Approximation Time	
	ADC 0	6
	ADC 1	6
	▼ Synchronous Operation	
	Enable for ADC 0	Disable
	Enable for ADC 1	Disable
	Synchronous Operation Period Cycle	100
	▼ Calibration	
	▼ A/D Calibration	
	Sampling Time	10
	Conversion Time	6
	▼ Sample and Hold Calibration	
	Sampling Time	25
	Hold Time	3
	▼ Sampling State Table	
	Entry 0	10
	Entry 1	95
	Entry 2	95
	Entry 3	95
	Entry 4	95
	Entry 5	95
	Entry 6	95
	Entry 7	95
	Entry 8	95
	Entry 9	95
	Entry 10	95
	Entry 11	95
	Entry 12	95
	Entry 13	95
	Entry 14	95
	Entry 15	95
	Name	g_adc0

Figure 2-3 FSP configuration of ADC driver [1/6]

g_adc0 ADC Driver on r_adc_b		
Settings	Property	Value
API Info	> Common	
	▼ Module g_adc0 ADC Driver on r_adc_b	
	> General	
	▼ Clock Configuration	
	Divider	Div /1
	Source	PCLKC
	▼ Interrupts	
	> Limiter Clip Priority	
	> Conversion Error Priority	
	> Overflow Priority	
	> Calibration End Priority	
	▼ Scan End Priority	
	Group 0	Priority 5
	Group 1	Disabled
	Group 2	Disabled
	Group 3	Disabled
	Group 4	Disabled
	Group 5 to 8	Disabled
	> FIFO Priorities	
	Callback	rm_motor_driver_cyclic
	▼ Sample and Hold	
	▼ Enable Unit	
Unit 0	<input checked="" type="checkbox"/>	
Unit 1	<input type="checkbox"/>	
Unit 2	<input checked="" type="checkbox"/>	
Unit 4	<input type="checkbox"/>	
Unit 5	<input type="checkbox"/>	
Unit 6	<input type="checkbox"/>	
▼ Analog Channels 0-5		
Sampling Time	25	
Hold Time	3	
▼ Analog Channels 6-11		
Sampling Time	95	
Hold Time	5	

Figure 2-4 FSP configuration of ADC driver [2/6]

g_adc0 ADC Driver on r_adc_b		
Settings	Property	Value
API Info	▼ Virtual Channels	
	▼ Virtual Channel 0	
	Scan Group	Scan Group 0
	Channel Select	AN000
	Sampling State Table ID	Sampling State Entry 0
	Channel Gain Table	Disabled
	Channel Offset Table	Disabled
	Add/Average Mode	Disabled
	Add/Average Count	1-time conversion (Normal Conversion)
	Limit Clip Table Id	Disabled
	Conversion Data Format Select	12-bit Data Format
	Digital Filter Selection	Disabled
	▼ Virtual Channel 1	
	Scan Group	Scan Group 0
	Channel Select	AN002
	Sampling State Table ID	Sampling State Entry 0
	Channel Gain Table	Disabled
	Channel Offset Table	Disabled
	Add/Average Mode	Disabled
	Add/Average Count	1-time conversion (Normal Conversion)
	Limit Clip Table Id	Disabled
	Conversion Data Format Select	12-bit Data Format
	Digital Filter Selection	Disabled
	▼ Virtual Channel 2	
	Scan Group	Scan Group 0
	Channel Select	AN004
	Sampling State Table ID	Sampling State Entry 0
Channel Gain Table	Disabled	
Channel Offset Table	Disabled	
Add/Average Mode	Disabled	
Add/Average Count	1-time conversion (Normal Conversion)	
Limit Clip Table Id	Disabled	
Conversion Data Format Select	12-bit Data Format	
Digital Filter Selection	Disabled	

Figure 2-5 FSP configuration of ADC driver [3/6]

g_adc0 ADC Driver on r_adc_b		
Settings	Property	Value
API Info	Virtual Channels	
	Virtual Channel 0	
	Virtual Channel 1	
	Virtual Channel 2	
	Virtual Channel 3	
	Scan Group	Scan Group 1
	Channel Select	AN006
	Sampling State Table ID	Sampling State Entry 0
	Channel Gain Table	Disabled
	Channel Offset Table	Disabled
	Add/Average Mode	Disabled
	Add/Average Count	1-time conversion (Normal Conversion)
	Limit Clip Table Id	Disabled
	Conversion Data Format Select	12-bit Data Format
	Digital Filter Selection	Disabled
	Virtual Channel 4	
	Scan Group	Scan Group 1
	Channel Select	AN008
	Sampling State Table ID	Sampling State Entry 0
	Channel Gain Table	Disabled
	Channel Offset Table	Disabled
	Add/Average Mode	Disabled
	Add/Average Count	1-time conversion (Normal Conversion)
	Limit Clip Table Id	Disabled
Conversion Data Format Select	12-bit Data Format	
Digital Filter Selection	Disabled	

Figure 2-6 FSP configuration of ADC driver [4/6]

g_adc0 ADC Driver on r_adc_b		
Settings	Property	Value
API Info	Scan Groups	
	Scan Group 0	
	Self Diagnosis	
	External Trigger Enable	
	ELC Trigger Enable	
	GPT Trigger Enable	
	GPT Channel 0 Request A	<input type="checkbox"/>
	GPT Channel 1 Request A	<input type="checkbox"/>
	GPT Channel 2 Request A	<input type="checkbox"/>
	GPT Channel 3 Request A	<input type="checkbox"/>
	GPT Channel 4 Request A	<input checked="" type="checkbox"/>
	GPT Channel 5 Request A	<input type="checkbox"/>
	GPT Channel 6 Request A	<input type="checkbox"/>
	GPT Channel 7 Request A	<input type="checkbox"/>
	GPT Channel 8 Request A	<input type="checkbox"/>
	GPT Channel 9 Request A	<input type="checkbox"/>
	GPT Channel 0 Request B	<input type="checkbox"/>
	GPT Channel 1 Request B	<input type="checkbox"/>
	GPT Channel 2 Request B	<input type="checkbox"/>
	GPT Channel 3 Request B	<input type="checkbox"/>
	GPT Channel 4 Request B	<input type="checkbox"/>
	GPT Channel 5 Request B	<input type="checkbox"/>
	GPT Channel 6 Request B	<input type="checkbox"/>
	GPT Channel 7 Request B	<input type="checkbox"/>
GPT Channel 8 Request B	<input type="checkbox"/>	
GPT Channel 9 Request B	<input type="checkbox"/>	
Enable	Enable	
Converter Selection	ADC 0	
Start Trigger Delay	0	
Scan End Interrupt Enable	Enable	
Limit Clip Interrupt Enable	Disable	
FIFO Enable	Disable	
FIFO Interrupt Enable	Disable	
FIFO Interrupt Generation Level	0	

Figure 2-7 FSP configuration of ADC driver [5/6]

g_adc0 ADC Driver on r_adc_b		
Settings	Property	Value
API Info	▼ Scan Group 1	
	> Self Diagnosis	
	> External Trigger Enable	
	> ELC Trigger Enable	
	▼ GPT Trigger Enable	
	GPT Channel 0 Request A	<input type="checkbox"/>
	GPT Channel 1 Request A	<input type="checkbox"/>
	GPT Channel 2 Request A	<input type="checkbox"/>
	GPT Channel 3 Request A	<input type="checkbox"/>
	GPT Channel 4 Request A	<input checked="" type="checkbox"/>
	GPT Channel 5 Request A	<input type="checkbox"/>
	GPT Channel 6 Request A	<input type="checkbox"/>
	GPT Channel 7 Request A	<input type="checkbox"/>
	GPT Channel 8 Request A	<input type="checkbox"/>
	GPT Channel 9 Request A	<input type="checkbox"/>
	GPT Channel 0 Request B	<input type="checkbox"/>
	GPT Channel 1 Request B	<input type="checkbox"/>
	GPT Channel 2 Request B	<input type="checkbox"/>
	GPT Channel 3 Request B	<input type="checkbox"/>
	GPT Channel 4 Request B	<input type="checkbox"/>
	GPT Channel 5 Request B	<input type="checkbox"/>
	GPT Channel 6 Request B	<input type="checkbox"/>
	GPT Channel 7 Request B	<input type="checkbox"/>
	GPT Channel 8 Request B	<input type="checkbox"/>
	GPT Channel 9 Request B	<input type="checkbox"/>
	Enable	Enable
	Converter Selection	ADC 1
Start Trigger Delay	0	
Scan End Interrupt Enable	Disable	
Limit Clip Interrupt Enable	Disable	
FIFO Enable	Disable	
FIFO Interrupt Enable	Disable	
FIFO Interrupt Generation Level	0	

Figure 2-8 FSP configuration of ADC driver [6/6]

g_timer3 Timer, Low-Power (r_agt)		
Settings	Property	Value
API Info	> Common	
	▼ Module g_timer3 Timer, Low-Power (r_agt)	
	▼ General	
	Name	g_timer3
	Channel	0
	Mode	Periodic
	Period	500
	Period Unit	Microseconds
	Count Source	PCLKB
	> Output	
	> Input	
	▼ Interrupts	
	Callback	rm_motor_speed_cyclic
	Underflow Interrupt Priority	Priority 10
	> Pins	

Figure 2-9 FSP configuration of AGT driver

g_timer0 Timer, General PWM (r_gpt)		
Settings	Property	Value
API Info	▼ Common	
	Parameter Checking	Default (BSP)
	Pin Output Support	Enabled with Extra Features
	Write Protect Enable	Disabled
	Clock Source	PCLKD
	▼ Module g_timer0 Timer, General PWM (r_gpt)	
	▼ General	
	Name	g_timer0
	Channel	4
	Mode	Triangle-Wave Symmetric PWM
	Period	50.0
	Period Unit	Microseconds
	> Output	
	> Input	
	> Interrupts	
	▼ Extra Features	
	▼ Output Disable	
	> Output Disable POEG Trigger	
	POEG Link	POEG Channel 3
	GTIOCA Disable Setting	Set Hi Z
	GTIOCB Disable Setting	Set Hi Z
	▼ ADC Trigger	
	▼ Start Event Trigger (Channels with GTINTAD only)	
	Trigger Event A/D Converter Start Request A During Up Counting	<input type="checkbox"/>
	Trigger Event A/D Converter Start Request A During Down Counting	<input checked="" type="checkbox"/>
	Trigger Event A/D Converter Start Request B During Up Counting	<input type="checkbox"/>
	Trigger Event A/D Converter Start Request B During Down Counting	<input type="checkbox"/>
> Dead Time (Value range varies with Channel)		
> ADC Trigger (Channels with GTADTRA only)		
> ADC Trigger (Channels with GTADTRB only)		
> Interrupt Skipping (Channels with GTITC only)		
Extra Features	Enabled	
> Pins		

Figure 2-10 FSP configuration of GPT driver

g_poeg0 Port Output Enable for GPT (r_poeg)		
Settings	Property	Value
API Info	> Common	
	▼ Module g_poeg0 Port Output Enable for GPT (r_poeg)	
	▼ General	
	▼ Trigger	
	GTETRГ Pin	<input checked="" type="checkbox"/>
	GPT Output Level	<input type="checkbox"/>
	Oscillation Stop	<input type="checkbox"/>
	ACMPHS0	<input type="checkbox"/>
	ACMPHS1	<input type="checkbox"/>
	ACMPHS2	<input type="checkbox"/>
	ACMPHS3	<input type="checkbox"/>
	Name	g_poeg0
	Channel	3
	▼ Input	
	GTETRГ Polarity	Active Low
GTETRГ Noise Filter	PCLKB/32	
▼ Interrupts		
Callback	g_poe_overcurrent	
Interrupt Priority	Priority 0 (highest)	

Figure 2-11 FSP Configuration of POEG driver

2.2.3.2 RA4T1

(1) A/D Converter (ADC12)

U-phase current, W-phase current, inverter bus voltage, and rotation speed command are measured in "Single Scan Mode" (use a hardware trigger). A/D conversion is implemented to be synchronized with carrier synchronized interrupt.

(2) Low Power Asynchronous General-Purpose Timer (AGT)

The AGT is used as 1 [ms] interval timer.

(3) General PWM Timer (GPT)

On the channel 1,2 and 3, output with dead time is performed by using the complementary PWM Output Operating Mode.

(4) Port Output Enable for GPT (POEG)

The port executing PWM output are set to high impedance state when an overcurrent is detected (when a low level of the GTETRGB port is detected).

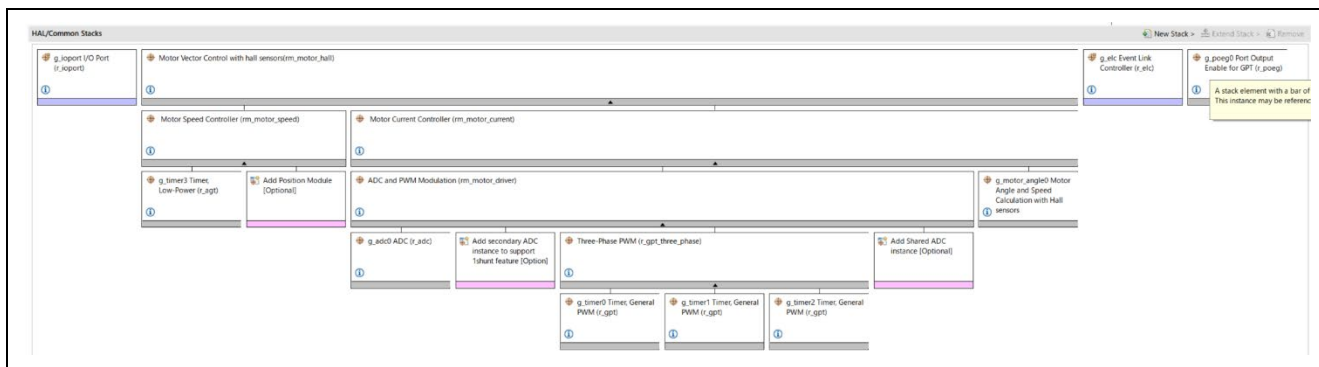

Figure 2-12 Overall FSP stacks diagram

g_adc0 ADC (r_adc)		
Settings	プロパティ	
API Info		
	▼ Common	
	Parameter Checking	Default (BSP)
	▼ Module g_adc0 ADC (r_adc)	
	▼ General	
	Name	g_adc0
	Unit	0
	Resolution	12-Bit
	Alignment	Right
	Clear after read	On
	Mode	Single Scan
	Double-trigger	Disabled
	> Input	
	▼ Interrupts	
	Normal/Group A Trigger	GPT1 COUNTER UNDERFLOW (Underflow)
	Group B Trigger	Disabled
	Group Priority (Valid only in Group Scan Mode)	Group A cannot interrupt Group B
	Callback	rm_motor_driver_cyclic
	Scan End Interrupt Priority	Priority 5
	Scan End Group B Interrupt Priority	Disabled
	Window Compare A Interrupt Priority	Disabled
	Window Compare B Interrupt Priority	Disabled
	> Extra	

Figure 2-13 FSP configuration of ADC driver [1/2]

g_adc0 ADC (r_adc)		
Settings	プロパティ	値
API Info	▼ Input	
	▼ Channel Scan Mask (channel availability varies by MCU)	
	Channel 0	<input checked="" type="checkbox"/>
	Channel 1	<input type="checkbox"/>
	Channel 2	<input checked="" type="checkbox"/>
	Channel 3	<input type="checkbox"/>
	Channel 4	<input checked="" type="checkbox"/>
	Channel 5	<input checked="" type="checkbox"/>
	Channel 6	<input type="checkbox"/>
	Channel 7	<input type="checkbox"/>
	Channel 8	<input type="checkbox"/>
	Channel 9	<input type="checkbox"/>
	Channel 10	<input type="checkbox"/>
	Channel 11	<input type="checkbox"/>
	Channel 12	<input type="checkbox"/>
	Channel 13	<input type="checkbox"/>
	Channel 14	<input type="checkbox"/>
	Channel 15	<input type="checkbox"/>
	Channel 16	<input type="checkbox"/>
	Channel 17	<input type="checkbox"/>
	Channel 18	<input type="checkbox"/>
	Channel 19	<input type="checkbox"/>
	Channel 20	<input type="checkbox"/>
	Channel 21	<input type="checkbox"/>
	Channel 22	<input type="checkbox"/>
	Channel 23	<input type="checkbox"/>
	Channel 24	<input type="checkbox"/>
	Channel 25	<input type="checkbox"/>
	Channel 26	<input type="checkbox"/>
Channel 27	<input type="checkbox"/>	
Channel 28	<input type="checkbox"/>	
Temperature Sensor	<input type="checkbox"/>	
Internal Reference Voltage	<input type="checkbox"/>	

Figure 2-14 FSP configuration of ADC driver [2/2]

g_timer3 Timer, Low-Power (r_agt)		
Settings	プロパティ	値
API Info	▼ Common	
	Parameter Checking	Default (BSP)
	Pin Output Support	Disabled
	Pin Input Support	Disabled
	▼ Module g_timer3 Timer, Low-Power (r_agt)	
	▼ General	
	Name	g_timer3
	Counter Bit Width	AGTW 32-bit
	Channel	0
	Mode	Periodic
	Period	1
	Period Unit	Milliseconds
	Count Source	PCLKB
	> Output	
> Input		
▼ Interrupts		
Callback	rm_motor_speed_cyclic	
Underflow Interrupt Priority	Priority 10	

Figure 2-15 FSP configuration of AGT driver

g_timer0 Timer, General PWM (r_gpt)		
Settings	プロパティ	値
API Info	▼ Common	
	Parameter Checking	Default (BSP)
	Pin Output Support	Enabled with Extra Features
	Write Protect Enable	Disabled
	▼ Module g_timer0 Timer, General PWM (r_gpt)	
	▼ General	
	Name	g_timer0
	Channel	1
	Mode	Triangle-Wave Symmetric PWM
	Period	50.0
	Period Unit	Microseconds
	> Output	
	> Input	
	> Interrupts	
	▼ Extra Features	
	▼ Output Disable	
	▼ Output Disable POEG Trigger	
	Dead Time Error	<input type="checkbox"/>
	GTIOCA and GTIOCB High Level	<input type="checkbox"/>
	GTIOCA and GTIOCB Low Level	<input type="checkbox"/>
	POEG Link	POEG Channel 1
	GTIOCA Disable Setting	Set Hi Z
	GTIOCB Disable Setting	Set Hi Z
	▼ ADC Trigger	
	▼ Start Event Trigger (Channels with GTINTAD only)	
	Trigger Event A/D Converter Start Request A During Up Counting	<input type="checkbox"/>
	Trigger Event A/D Converter Start Request A During Down Counting	<input checked="" type="checkbox"/>
	Trigger Event A/D Converter Start Request B During Up Counting	<input type="checkbox"/>
	Trigger Event A/D Converter Start Request B During Down Counting	<input type="checkbox"/>
	> Dead Time (Value range varies with Channel)	
	> ADC Trigger (Channels with GTADTRA only)	
	> ADC Trigger (Channels with GTADTRB only)	
	> Interrupt Skipping (Channels with GTITC only)	
	Extra Features	Enabled

Figure 2-16 FSP configuration of GPT driver

g_poeg0 Port Output Enable for GPT (r_poeg)		
Settings	プロパティ	値
API Info	▼ Common	
	Parameter Checking	Default (BSP)
	▼ Module g_poeg0 Port Output Enable for GPT (r_poeg)	
	▼ General	
	▼ Trigger	
	GTETRГ Pin	<input checked="" type="checkbox"/>
	GPT Output Level	<input type="checkbox"/>
	Oscillation Stop	<input type="checkbox"/>
	ACMPHS0	<input type="checkbox"/>
	ACMPHS1	<input type="checkbox"/>
	ACMPHS2	<input type="checkbox"/>
	Name	g_poeg0
	Channel	1
	▼ Input	
	GTETRГ Polarity	Active Low
	GTETRГ Noise Filter	PCLKB/128
	▼ Interrupts	
	Callback	g_poe_overcurrent
	Interrupt Priority	Priority 0 (highest)

Figure 2-17 FSP Configuration of POEG driver

2.2.3.3 RA6T3

(1) A/D Converter (ADC12)

U-phase current, W-phase current, inverter bus voltage, and rotation speed command are measured in "Single Scan Mode" (use a hardware trigger). A/D conversion is implemented to be synchronized with carrier synchronized interrupt.

(2) Low Power Asynchronous General-Purpose Timer (AGT)

The AGT is used as 500 [us] interval timer.

(3) General PWM Timer (GPT)

On the channel 1,2 and 3, output with dead time is performed by using the complementary PWM Output Operating Mode.

(4) Port Output Enable for GPT (POEG)

The port executing PWM output are set to high impedance state when an overcurrent is detected (when a low level of the GTETRGB port is detected).

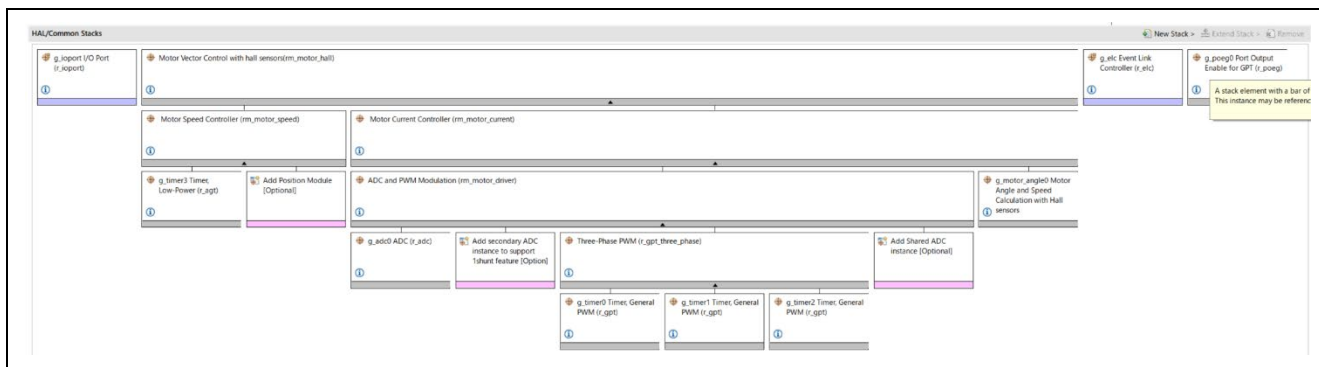

Figure 2-18 Overall FSP stacks diagram

g_adc0 ADC (r_adc)		
Settings	プロパティ	
API Info		
	▼ Common	
	Parameter Checking	Default (BSP)
	▼ Module g_adc0 ADC (r_adc)	
	▼ General	
	Name	g_adc0
	Unit	0
	Resolution	12-Bit
	Alignment	Right
	Clear after read	On
	Mode	Single Scan
	Double-trigger	Disabled
	> Input	
	▼ Interrupts	
	Normal/Group A Trigger	GPT1 COUNTER UNDERFLOW (Underflow)
	Group B Trigger	Disabled
	Group Priority (Valid only in Group Scan Mode)	Group A cannot interrupt Group B
	Callback	rm_motor_driver_cyclic
	Scan End Interrupt Priority	Priority 5
	Scan End Group B Interrupt Priority	Disabled
	Window Compare A Interrupt Priority	Disabled
	Window Compare B Interrupt Priority	Disabled
	> Extra	

Figure 2-19 FSP configuration of ADC driver [1/2]

g_adc0 ADC (r_adc)		
Settings	プロパティ	値
API Info	Input	
	Channel Scan Mask (channel availability varies by MCU)	
	Channel 0	<input checked="" type="checkbox"/>
	Channel 1	<input type="checkbox"/>
	Channel 2	<input checked="" type="checkbox"/>
	Channel 3	<input type="checkbox"/>
	Channel 4	<input checked="" type="checkbox"/>
	Channel 5	<input checked="" type="checkbox"/>
	Channel 6	<input type="checkbox"/>
	Channel 7	<input type="checkbox"/>
	Channel 8	<input type="checkbox"/>
	Channel 9	<input type="checkbox"/>
	Channel 10	<input type="checkbox"/>
	Channel 11	<input type="checkbox"/>
	Channel 12	<input type="checkbox"/>
	Channel 13	<input type="checkbox"/>
	Channel 14	<input type="checkbox"/>
	Channel 15	<input type="checkbox"/>
	Channel 16	<input type="checkbox"/>
	Channel 17	<input type="checkbox"/>
	Channel 18	<input type="checkbox"/>
	Channel 19	<input type="checkbox"/>
	Channel 20	<input type="checkbox"/>
	Channel 21	<input type="checkbox"/>
	Channel 22	<input type="checkbox"/>
	Channel 23	<input type="checkbox"/>
	Channel 24	<input type="checkbox"/>
	Channel 25	<input type="checkbox"/>
	Channel 26	<input type="checkbox"/>
Channel 27	<input type="checkbox"/>	
Channel 28	<input type="checkbox"/>	
Temperature Sensor	<input type="checkbox"/>	
Internal Reference Voltage	<input type="checkbox"/>	

Figure 2-20 FSP configuration of ADC driver [2/2]

g_timer3 Timer, Low-Power (r_agt)		
Settings	プロパティ	値
API Info	Common	
	Parameter Checking	Default (BSP)
	Pin Output Support	Disabled
	Pin Input Support	Disabled
	Module g_timer3 Timer, Low-Power (r_agt)	
	General	
	Name	g_timer3
	Counter Bit Width	AGTW 32-bit
	Channel	0
	Mode	Periodic
	Period	500
	Period Unit	Microseconds
	Count Source	PCLKB
	Interrupts	
Callback	rm_motor_speed_cyclic	
Underflow Interrupt Priority	Priority 10	

Figure 2-21 FSP configuration of AGT driver

g_timer0 Timer, General PWM (r_gpt)		
Settings	プロパティ	値
API Info	▼ Common	
	Parameter Checking	Default (BSP)
	Pin Output Support	Enabled with Extra Features
	Write Protect Enable	Disabled
	▼ Module g_timer0 Timer, General PWM (r_gpt)	
	▼ General	
	Name	g_timer0
	Channel	1
	Mode	Triangle-Wave Symmetric PWM
	Period	50.0
	Period Unit	Microseconds
	> Output	
	> Input	
	> Interrupts	
	▼ Extra Features	
	▼ Output Disable	
	▼ Output Disable POEG Trigger	
	Dead Time Error	<input type="checkbox"/>
	GTIOCA and GTIOCB High Level	<input type="checkbox"/>
	GTIOCA and GTIOCB Low Level	<input type="checkbox"/>
	POEG Link	POEG Channel 1
	GTIOCA Disable Setting	Set Hi Z
	GTIOCB Disable Setting	Set Hi Z
	▼ ADC Trigger	
	▼ Start Event Trigger (Channels with GTINTAD only)	
	Trigger Event A/D Converter Start Request A During Up Counting	<input type="checkbox"/>
	Trigger Event A/D Converter Start Request A During Down Counting	<input checked="" type="checkbox"/>
	Trigger Event A/D Converter Start Request B During Up Counting	<input type="checkbox"/>
	Trigger Event A/D Converter Start Request B During Down Counting	<input type="checkbox"/>
	> Dead Time (Value range varies with Channel)	
	> ADC Trigger (Channels with GTADTRA only)	
	> ADC Trigger (Channels with GTADTRB only)	
	> Interrupt Skipping (Channels with GTITC only)	
	Extra Features	Enabled

Figure 2-22 FSP configuration of GPT driver

g_poeg0 Port Output Enable for GPT (r_poeg)		
Settings	プロパティ	値
API Info	▼ Common	
	Parameter Checking	Default (BSP)
	▼ Module g_poeg0 Port Output Enable for GPT (r_poeg)	
	▼ General	
	▼ Trigger	
	GTETRГ Pin	<input checked="" type="checkbox"/>
	GPT Output Level	<input type="checkbox"/>
	Oscillation Stop	<input type="checkbox"/>
	ACMPHS0	<input type="checkbox"/>
	ACMPHS1	<input type="checkbox"/>
	ACMPHS2	<input type="checkbox"/>
	Name	g_poeg0
	Channel	1
	▼ Input	
	GTETRГ Polarity	Active Low
	GTETRГ Noise Filter	PCLKB/128
	▼ Interrupts	
	Callback	g_poe_overcurrent
	Interrupt Priority	Priority 0 (highest)

Figure 2-23 FSP Configuration of POEG driver

2.2.3.4 RA8T1

(1) A/D Converter (ADC12)

U-phase current, W-phase current, inverter bus voltage, and rotation speed command are measured in "Single Scan Mode" (use a hardware trigger). A/D conversion is implemented to be synchronized with carrier synchronized interrupt.

(2) Low Power Asynchronous General-Purpose Timer (AGT)

The AGT is used as 500 [μs] interval timer.

(3) General PWM Timer (GPT)

On the channel 2,3 and 5, output with dead time is performed by using the complementary PWM Output Operating Mode.

(4) Port Output Enable for GPT (POEG)

The port executing PWM output are set to high impedance state when an overcurrent is detected (when a low level of the GTETRGD port is detected).

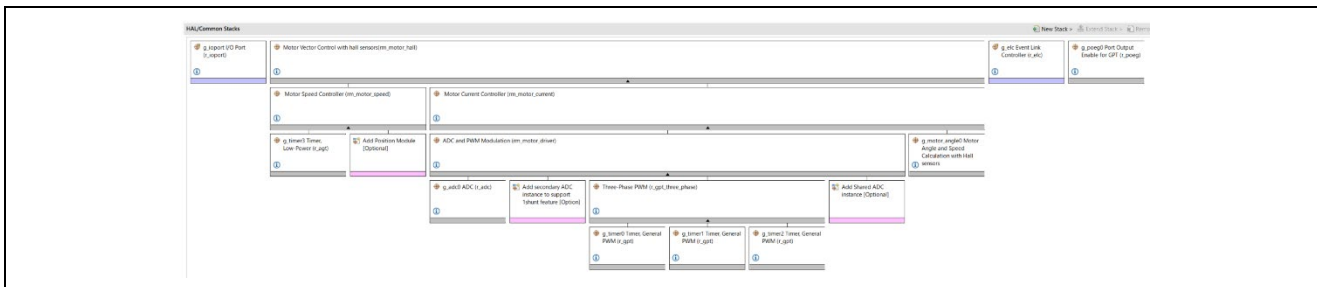

Figure 2-24 Overall FSP stacks diagram

g_adc0 ADC (r_adc)		
Settings	プロパティ	値
API Info	▼ Common	
	Parameter Checking	Default (BSP)
	▼ Module g_adc0 ADC (r_adc)	
	▼ General	
	Name	g_adc0
	Unit	0
	Resolution	12-Bit
	Alignment	Right
	Clear after read	On
	Mode	Single Scan
	Double-trigger	Disabled
	> Input	
	▼ Interrupts	
	Normal/Group A Trigger	Software
	Group B Trigger	Disabled
	Group Priority (Valid only in Group Scan Mode)	Group A cannot interrupt Group B
Callback	rm_motor_driver_cyclic	
Scan End Interrupt Priority	Priority 5	
Scan End Group B Interrupt Priority	Disabled	
Window Compare A Interrupt Priority	Disabled	
Window Compare B Interrupt Priority	Disabled	

Figure 2-25 FSP configuration of ADC driver [1/2]

g_timer0 Timer, General PWM (r_gpt)		
Settings	プロパティ	値
API Info	▼ Common	
	Parameter Checking	Default (BSP)
	Pin Output Support	Enabled with Extra Features
	Write Protect Enable	Disabled
	▼ Module g_timer0 Timer, General PWM (r_gpt)	
	▼ General	
	Name	g_timer0
	Channel	5
	Mode	Triangle-Wave Symmetric PWM
	Period	50.0
	Period Unit	Microseconds
	> Output	
	> Input	
	> Interrupts	
	▼ Extra Features	
	▼ Output Disable	
	▼ Output Disable POEG Trigger	
	Dead Time Error	<input type="checkbox"/>
	GTIOCA and GTIOCB High Level	<input type="checkbox"/>
	GTIOCA and GTIOCB Low Level	<input type="checkbox"/>
	POEG Link	POEG Channel 0
	GTIOCA Disable Setting	Set Hi Z
	GTIOCB Disable Setting	Set Hi Z
	▼ ADC Trigger	
	▼ Start Event Trigger (Channels with GTINTAD only)	
	Trigger Event A/D Converter Start Request A During Up Counting	<input type="checkbox"/>
	Trigger Event A/D Converter Start Request A During Down Counting	<input type="checkbox"/>
	Trigger Event A/D Converter Start Request B During Up Counting	<input type="checkbox"/>
	Trigger Event A/D Converter Start Request B During Down Counting	<input type="checkbox"/>
	> Dead Time (Value range varies with Channel)	
	> ADC Trigger (Channels with GTADTRA only)	
	> ADC Trigger (Channels with GTADTRB only)	
	> Interrupt Skipping (Channels with GTITC only)	
	Extra Features	Enabled

Figure 2-26 FSP configuration of ADC driver [2/2]

g_timer3 Timer, Low-Power (r_agt)		
Settings	プロパティ	値
API Info	▼ Common	
	Parameter Checking	Default (BSP)
	Pin Output Support	Disabled
	Pin Input Support	Disabled
	▼ Module g_timer3 Timer, Low-Power (r_agt)	
	▼ General	
	Name	g_timer3
	Counter Bit Width	AGT 16-bit
	Channel	0
	Mode	Periodic
	Period	500
	Period Unit	Microseconds
	Count Source	PCLKB
	> Output	
	> Input	
	▼ Interrupts	
	Callback	rm_motor_speed_cyclic
	Underflow Interrupt Priority	Priority 10

Figure 2-27 FSP configuration of AGT driver

g_timer0 Timer, General PWM (r_gpt)		
Settings	プロパティ	値
API Info	▼ Common	
	Parameter Checking	Default (BSP)
	Pin Output Support	Enabled with Extra Features
	Write Protect Enable	Disabled
	▼ Module g_timer0 Timer, General PWM (r_gpt)	
	▼ General	
	Name	g_timer0
	Channel	5
	Mode	Triangle-Wave Symmetric PWM
	Period	50.0
	Period Unit	Microseconds
	> Output	
	> Input	
	> Interrupts	
	▼ Extra Features	
	▼ Output Disable	
	▼ Output Disable POEG Trigger	
	Dead Time Error	<input type="checkbox"/>
	GTIOCA and GTIOCB High Level	<input type="checkbox"/>
	GTIOCA and GTIOCB Low Level	<input type="checkbox"/>
	POEG Link	POEG Channel 0
	GTIOCA Disable Setting	Set Hi Z
	GTIOCB Disable Setting	Set Hi Z
	▼ ADC Trigger	
	▼ Start Event Trigger (Channels with GTINTAD only)	
	Trigger Event A/D Converter Start Request A During Up Counting	<input type="checkbox"/>
	Trigger Event A/D Converter Start Request A During Down Counting	<input type="checkbox"/>
	Trigger Event A/D Converter Start Request B During Up Counting	<input type="checkbox"/>
	Trigger Event A/D Converter Start Request B During Down Counting	<input type="checkbox"/>
	> Dead Time (Value range varies with Channel)	
	> ADC Trigger (Channels with GTADTRA only)	
	> ADC Trigger (Channels with GTADTRB only)	
	> Interrupt Skipping (Channels with GTITC only)	
	Extra Features	Enabled

Figure 2-28 FSP configuration of GPT driver

g_poeg0 Port Output Enable for GPT (r_poeg)		
Settings	プロパティ	値
API Info	▼ Common	
	Parameter Checking	Default (BSP)
	▼ Module g_poeg0 Port Output Enable for GPT (r_poeg)	
	▼ General	
	▼ Trigger	
	GTETRG Pin	<input checked="" type="checkbox"/>
	GPT Output Level	<input type="checkbox"/>
	Oscillation Stop	<input type="checkbox"/>
	ACMPHS0	<input type="checkbox"/>
	ACMPHS1	<input type="checkbox"/>
	Name	g_poeg0
	Channel	0
	▼ Input	
	GTETRG Polarity	Active Low
	GTETRG Noise Filter	PCLKB/128
	▼ Interrupts	
	Callback	g_poe_overcurrent
	Interrupt Priority	Priority 0 (highest)

Figure 2-29 FSP Configuration of POEG driver

2.3 Software configuration

2.3.1 Software file configuration

Folder and file configuration of the software is given below.

Table 2-7 File and folder configuration [1/2]

Folder	Subfolder	File	Remarks	
ra_cfg			Generated config header	
ra_gen			Generated register setting, main function etc	
ra	arm		CMSIS source code	
	board		Function definition for board	
	fsp/inc/api		bsp_api.h	BSP API definition
			r_adc_api.h	AD API definition
			r_elc_api.h(Only RA4T1,RA6T3 and RA8T1)	ELC API definition
			r_ioport_api.h	I/O API definition
			r_poeg_api.h	POEG API definition
			r_three_phase_api.h	3phase PWM API definition
			r_timer_api.h	Timer API definition
			r_transfer_api.h	Transfer API definition
			rm_motor_angle_api.h	Angle API definition
			rm_motor_api.h	Motor API definition
			rm_motor_current_api.h	Current API definition
			rm_motor_driver_api.h	Motor driver API definition
			rm_motor_speed_api.h	Speed API definition
	fsp/inc/instances		r_adc_b.h(RA6T2)	Function definition for AD
			r_adc.h(RA4T1,RA6T3 and RA8T1)	
			r_agt.h	Function definition for AGT
			r_elc.h(Only RA4T1,RA6T3 and RA8T1)	Function definition for ELC
			r_gpt_three_phase.h	Function definition for 3 Phase PWM
			r_gpt.h	Function definition for GPT
			r_ioport.h	Function definition for I/O
			r_poeg.h	Function definition for POEG
			rm_motor_current.h	Function definition for current control
			rm_motor_driver.h	Function definition for motor driver
			rm_motor_sense_hall.h	Function definition for sense hall driver

Table 2-8 File and folder configuration [2/2]

Folder	Subfolder	File	Remarks	
ra	fsp/inc/instances	rm_motor_hall.h	Function definition for Hall driver	
		rm_motor_speed.h	Function definition for Speed driver	
	fsp/lib		Library files	
	fsp/src	bsp		BSP driver
		r_adc_b/r_adc_b.c		AD driver
		r_agt/r_agt.c		AGT driver
		r_gpt/r_gpt.c		POEG driver
		r_gpt_three_phase/r_gpt_three_phase.c		GPT driver
		r_ioport/r_ioport.c		3 phase PWM driver
		r_poeg/r_poeg.c		I/O driver
		rm_motor_current/rm_motor_current.c		POEG driver
		rm_motor_current/rm_motor_current_library.h		Current control driver
		rm_motor_sense_hall/rm_motor_sense_hall.c		Sense hall driver
		rm_motor_hall/rm_motor_hall.c		Motor application with vector control using hall sensors
		rm_motor_speed/rm_motor_speed.c		Speed control driver
rm_motor_speed/rm_motor_speed_library.h			Speed control library API definition	
src	application/main	mtr_main.h , mtr_main.c	User main function	
		r_mtr_control_parameter.h	Control parameters definition	
		r_mtr_motor_parameter.h	Motor parameters definition	
	application/user_interface/ics	r_mtr_ics.h , r_mtr_ics.c	Function definition for Analyzer	
		ICS2_RA6T2.h , ICS2_RA4T1.h , ICS2_RA6T3.h ICS2_RA8T1.h	Function definition for GUI tool	
		ICS2_RA6T2.h , ICS2_RA4T1.h , ICS2_RA6T3.h ICS2_RA8T1.h	Communication library for GUI tool	

2.3.2 Module configuration

Module configuration of the software is described below.

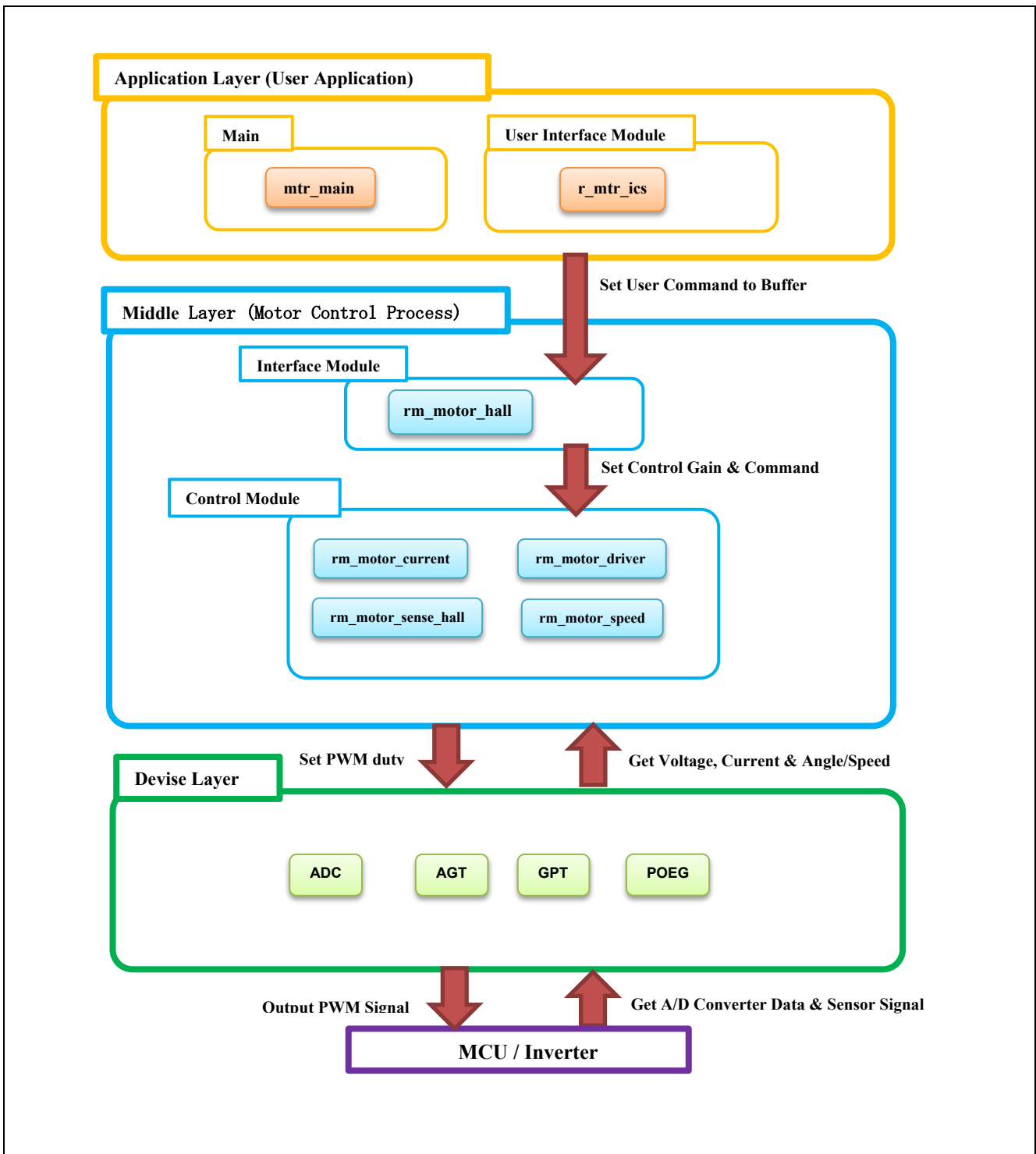

Figure 2-30 Module configuration

2.4 Software Specifications

Table 2-9 shows basic software specification of this system.

Table 2-9 Basic specifications of hall sensor vector control software

Item	Content	
Control method	Vector control	
Rotor angle and rotational speed detection method	Hall sensors	
Motor rotation start/stop	Determined depending on the level of SW1, or input from Renesas Motor Workbench	
Input voltage	DC 24V	
Main clock frequency	RA6T2 : 240 [MHz] RA6T3 : 200 [MHz] RA4T1 : 100 [MHz] RA8T1 : 480 [MHz]	
Carrier frequency (PWM)	20 [kHz] (Carrier period: 50 [μs])	
Dead time	2 [μs]	
Current control period	RA6T2 : 50 [μs] RA6T3 : 50 [μs] RA4T1 : 100 [μs] RA8T1 : 50 [μs]	
Speed control period	RA6T2 : 500 [μs] RA6T3 : 500 [μs] RA4T1 : 1000 [μs] RA8T1 : 500 [μs]	
Rotation speed control range	CW : 0 [rpm] to 2400 [rpm] CCW : 0 [rpm] to 2400 [rpm]	
Natural frequency of each control system	Current control system : 300 [Hz] Speed control system : 5 [Hz]	
Optimization setting of compiler	Optimization level	Optimize more(-O2) (default setting)
Processing stop for protection	<p>Disables the motor control signal output (six outputs), under any of the following conditions.</p> <ol style="list-style-type: none"> 1. Instantaneous value of current of any phase exceeds $3.54(=1.67 \times \sqrt{2}) \times 1.5$ [A] (monitored in current control period) 2. Inverter bus voltage exceeds 60 [V] (monitored in current control period) 3. Inverter bus voltage is less than 8 [V] (monitored in current control period) 4. Rotation speed exceeds 4500 [rpm] (monitored in current control period) <p>When an external over current signal is detected (when a low level is detected), the PWM output ports are set to high impedance state.</p>	

2.5 Interrupt Priority

Table 2-10 shows the interrupt and priorities used in this system.

Table 2-10 Interrupt priority

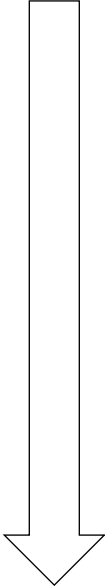
Interrupt level	Priority	Function
15	Min  Max	
14		
13		
12		
11		
10		AGT0 INT 500 [μsec] Interrupt handling (speed control)
9		
8		
7		
6		
5		ADC0 ADI0(RA6T2) ADC0 SCAN END(RA4T1, RA6T3 and RA8T1) A/D complete interrupt (current control)
4		
3		
2		
1		
0		POEG3 EVENT(RA6T2) POEG1 EVENT(RA4T1 , RA6T3) POEG0 EVENT(RA8T1) Over current error interrupt

Allocations		
Interrupt	Event	ISR
0	POEG3 EVENT (Port Output disable interrupt D)	poeg_event_isr
1	AGT0 INT (AGT interrupt)	agt_int_isr
2	ADC0 ADI0 (End of A/D scanning operation(Gr.0))	adc_b_adi0_isr

Figure 2-31 RA6T2 FSP Interrupts configuration

Allocations		
Interrupt	Event	ISR
0	AGT0 INT (AGT interrupt)	agt_int_isr
1	ADC0 SCAN END (A/D scan end interrupt)	adc_scan_end_isr
2	POEG1 EVENT (Port Output disable interrupt B)	poeg_event_isr

Figure 2-32 RA4T1/RA6T3 FSP Interrupts configuration

Allocations		
Interrupt	Event	ISR
0	AGT0 INT (AGT interrupt)	agt_int_isr
1	ADC0 SCAN END (End of A/D scanning operation)	adc_scan_end_isr
2	POEG0 EVENT (Port Output disable interrupt A)	poeg_event_isr

Figure 2-33 RA8T1 FSP Interrupts configuration

3. Descriptions of Control Program

3.1 Contents of Control

3.1.1 Motor start/stop

The start and stop of the motor are controlled by input from Renesas Motor Workbench or SW1.

SW1 is assigned to a general-purpose port. When the port is at a “High” level, it is determined that the start switch is being pressed. Conversely, when the level is switched to “Low”, the software determines that the motor should be stopped.

"High" level: Motor Start

"Low" level: Motor Stop

3.1.2 A/D converter

(1) Motor rotation speed reference

The motor rotation speed reference can be set by Renesas Motor Workbench input or A/D conversion of the VR1 output value (analog value). The A/D converted value is used as rotation speed command value, as shown below.

Table 3-1 Conversion ratio of rotation speed reference

Item	Conversion ratio (Reference: A/D conversion value)	
Rotation speed reference	CW	0 [rpm] to 2400[rpm] : 0800H to 0FFFH
	CCW	0 [rpm] to 2400[rpm] : 07FFH to 0000H

(2) Inverter bus voltage

Inverter bus voltage is measured as given in Table 3-2.

It is used for modulation factor calculation and over-/low-voltage detection. (When an abnormality is detected, PWM is stopped.)

Table 3-2 Inverter bus voltage conversion ratio

Item	Conversion ratio (Inverter bus voltage: A/D conversion value)
Inverter bus voltage	0 [V] to 73.26 [V] : 0000H to 0FFFH

(3) U, V, W phase current

The U, V and W phase currents are measured as shown in Table 3-3 and used for vector control.

Table 3-3 Conversion ratio of U and W phase current

Item	Conversion ratio (U, V, W phase current: A/D conversion value)
U, V, W phase current	-8.25 [A] to 8.25 [A] : 0000H to 0FFFH (Note)
	Current = $(3.3V - 1.65V) / (0.01\Omega \times 20) = 8.25A$

3.1.3 Modulation (current control module)

A modulated voltage can be output to improve the efficiency of voltage usage. The modulation operation is set from the API of the current control module.

3.1.3.1 Sine wave modulation (MOD_METHOD_SPWM)

The modulation factor m is defined as follows.

$$m = \frac{V}{E}$$

m : Modulation ratio V : Reference voltage E : Inverter input voltage

3.1.3.2 Space Vector Modulation (MOD_METHOD_SVPWM)

In vector control of a permanent magnet synchronous motor, generally, the desired voltage command value of each phase is generated sinusoidally. However, if the generated value is used as-is for the modulation wave for PWM generation, voltage utilization as applied to the motor (in terms of line voltage) is limited to a maximum of 86.7% with respect to inverter bus voltage. As such, as shown in the following expression, the average of the maximum and minimum values is calculated for the voltage command value of each phase, and the value obtained by subtracting the average from the voltage command value of each phase is used as the modulation wave. As a result, the maximum amplitude of the modulation wave is multiplied by $\sqrt{3}/2$, while voltage utilization becomes 100% and line voltage is unchanged.

$$\begin{pmatrix} V'_u \\ V'_v \\ V'_w \end{pmatrix} = \begin{pmatrix} V_u \\ V_v \\ V_w \end{pmatrix} + \Delta V \begin{pmatrix} 1 \\ 1 \\ 1 \end{pmatrix}$$

$$\therefore \Delta V = -\frac{V_{max} + V_{min}}{2}, \quad V_{max} = \max\{V_u, V_v, V_w\}, \quad V_{min} = \min\{V_u, V_v, V_w\}$$

V_u, V_v, V_w : Command values of U-, V-, and W-phases

V'_u, V'_v, V'_w : Command values of U-, V-, and W-phases for PWM generation (modulation wave)

The modulation factor m is defined as follows.

$$m = \frac{V'}{E}$$

m : Modulation ratio V' : Reference phase voltage for PWM
 E : Inverter input voltage

3.1.4 State transition

Figure 3-1 is a state transition diagram of the sample software. In the target software of this application note, the software state is managed by “SYSTEM MODE”.

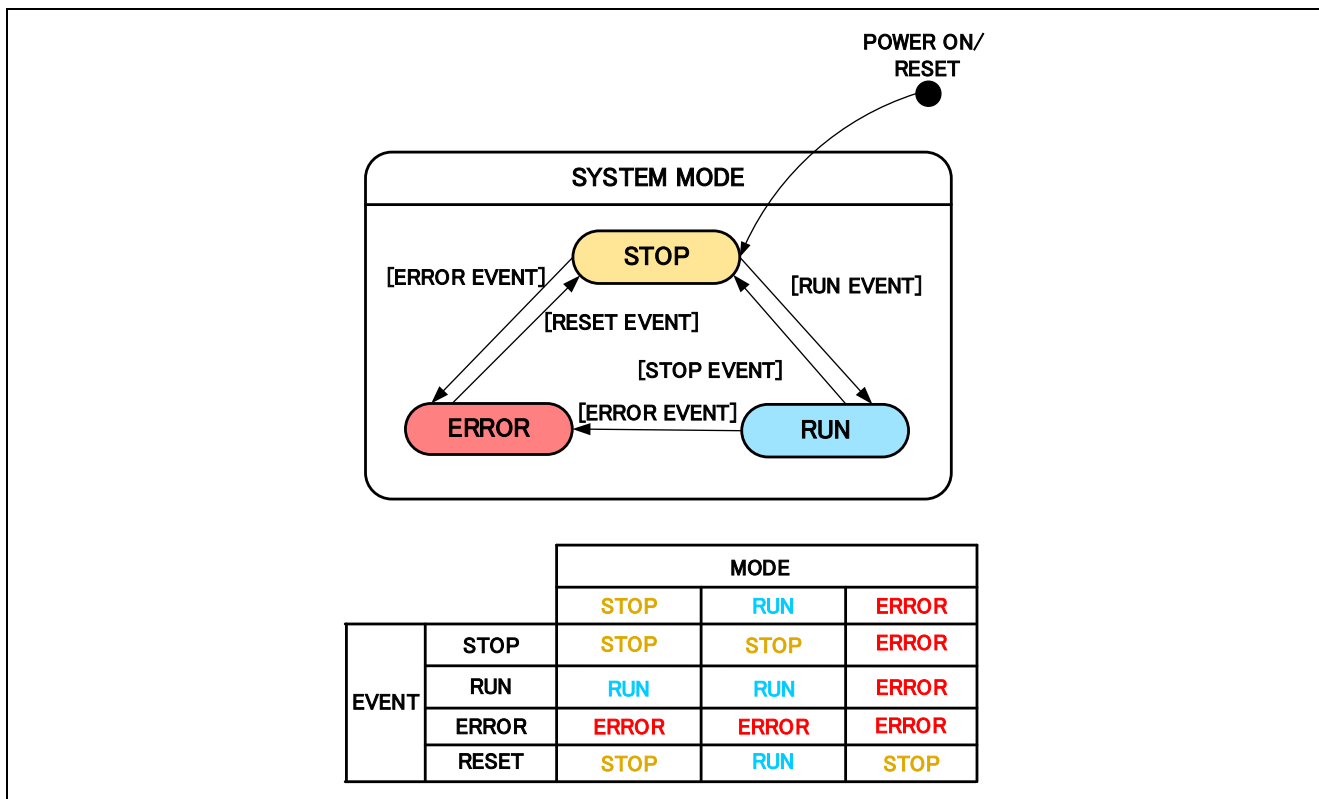

Figure 3-1 State transition diagram of hall sensor vector control software

(1) SYSTEM MODE

“SYSTEM MODE” indicates the operating states of the system. The state transits on occurrence of each event (EVENT). “SYSTEM MODE” has 3 states that are motor drive stop (INACTIVE), motor drive (ACTIVE), and abnormal condition (ERROR).

(2) EVENT

When “EVENT” occurs in each “SYSTEM MODE”, “SYSTEM MODE” changes as shown the table in Figure 3-1, according to that “EVENT”. The occurrence factors of each event are shown below.

Table 3-4 List of EVENT

EVENT name	Occurrence factor
STOP	by user operation
RUN	by user operation
ERROR	when the system detects an error
RESET	by user operation

3.1.5 Rotor angle and rotational speed estimation with hall sensors

3.1.5.1 Estimation of rotational speed

The rotational speed is estimated by below algorithm.

At every carrier interrupt (50μsec), hall sensors input signal are read, and the change in hall signal pattern is detected. Time for rotation by 60-degree electrical angle (period between each hall signal pattern change) is measured by counting the number of carrier interrupt.

$$\text{Period of 60 degree (electrical)} = \text{Number of carrier interrupt} * \text{Period of carrier interrupt [50}\mu\text{sec]}$$

From this equation, rotational speed (electrical) can be calculated.

$$\text{Rotational speed (electrical) [rad/sec]} = (2\pi * 60/360) / \text{Period of 60-degree (electrical) } [\mu\text{sec}]$$

However, if only one period of hall sensor signal change is used, there is a possibility of an error due to the tolerance of hall signal. Therefore, in this implementation, summation of last 6 periods of hall sensor signal changes is used to estimate the rotational speed.

$$\text{Rotational speed (electrical) [rad/sec]} = 2\pi / \text{Period of 360-degree (6 * 60-degree) (electrical) } [\mu\text{sec}]$$

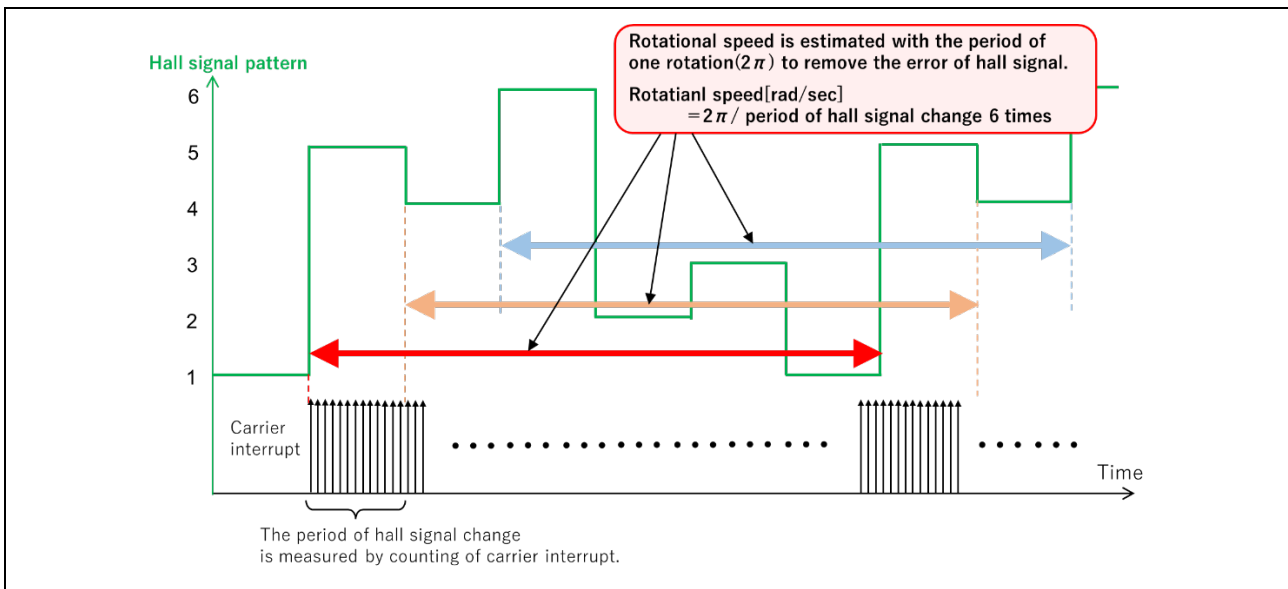

Figure 3-2 Concept design of estimation of rotational speed

To simplify the calculation, below replacements are used.

$$\text{Angle change per one carrier period (rad)} = 2\pi \text{ (rad)} / \text{counts of carrier interrupt during } 2\pi$$

$$\text{Rotational speed (electrical) (rad/sec)}$$

$$= \text{Angle change per carrier period (rad)} * \text{frequency of PWM carrier (Hz)}$$

3.1.5.2 Estimation of rotor angle

The rotor angle is estimated by below information.

- A) The direction of rotation
- B) The estimated rotational speed

The direction of rotation is detected by the hall sensor signal pattern. The hall sensor signal pattern is unique in each rotational direction. Therefore, the direction of rotation can be detected by comparison between current and last hall signal pattern.

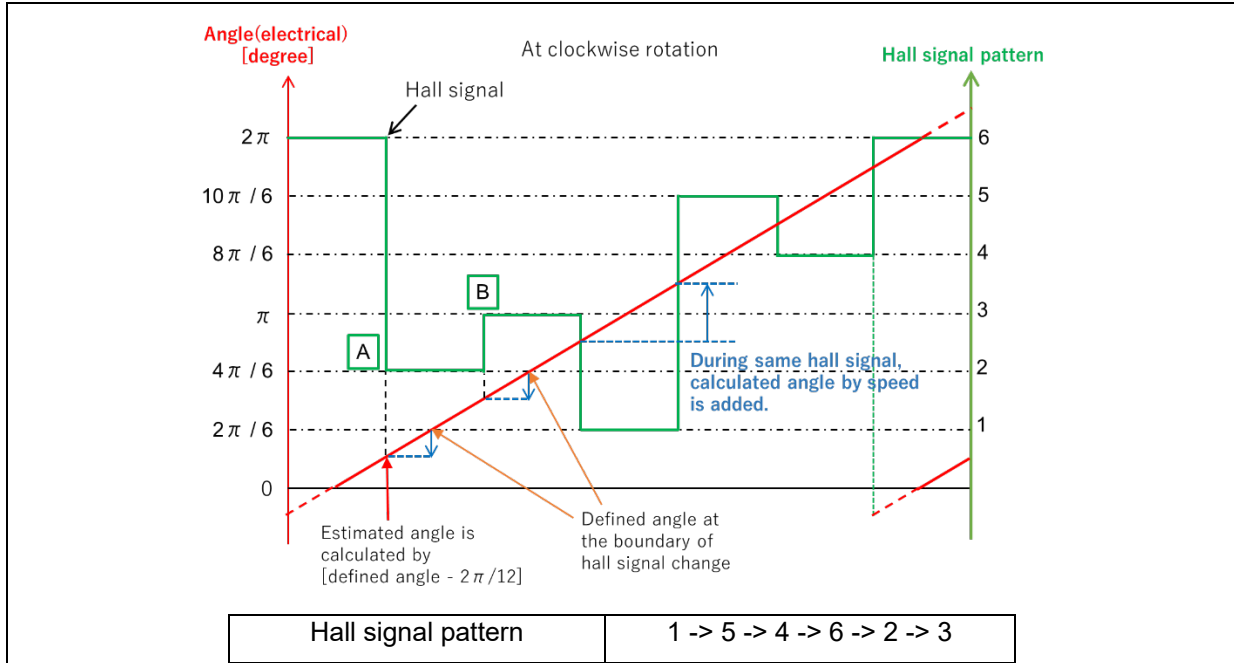

Figure 3-3 Estimation of rotor angle (at clockwise rotation)

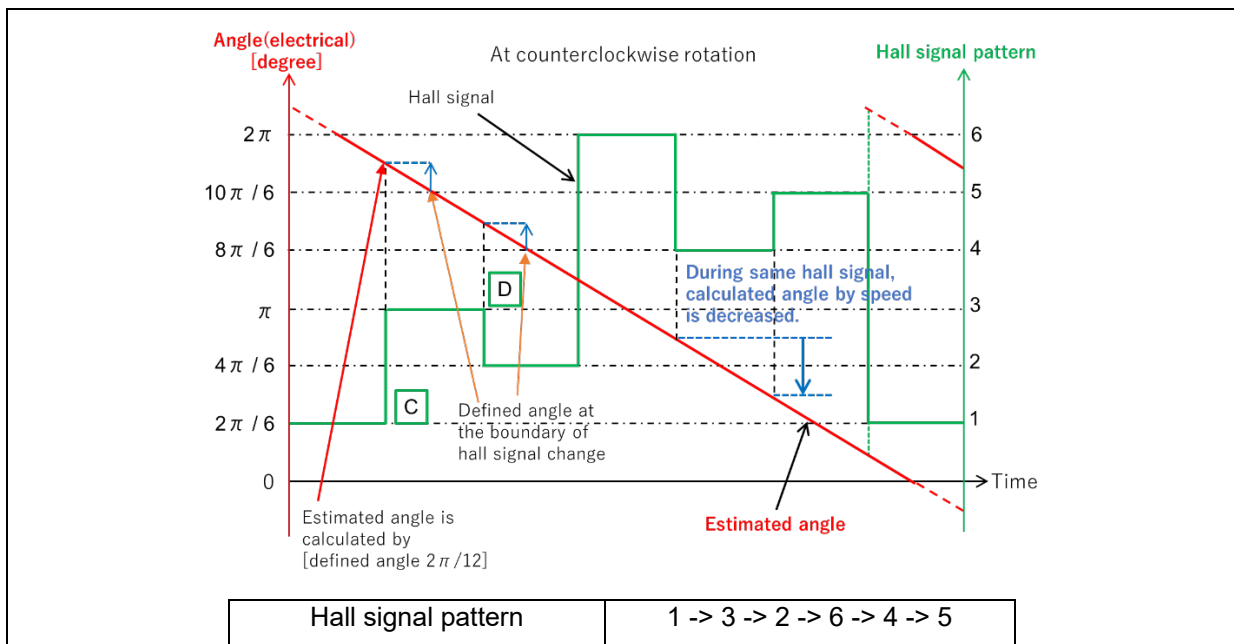

Figure 3-4 Estimation of rotor angle (at counterclockwise rotation)

At the point A in Figure 3-3, the hall signal changes 1 to 5. Therefore, the direction of rotation can be detected as clockwise. At this point A, the rotor angle is set as below.

$$\text{Rotor angle (rad)} = 2\pi * \text{adjustment value of standard angle (1/6)} + \text{internal angle (rad)} + \text{offset (rad)}$$

At the boundary of hall signal, rotor angle is estimated with standard angle ($2\pi/6$). This standard angle is set according to below table.

Table 3-5 List of adjustment value of standard angle

Hall signal	1	5	4	6	2	3
Adjustment value of standard angle	0 (0/6)	1/6	2/6	3/6	4/6	5/6

At the point A in Figure 3-3, the hall signal changes 1 to 5, therefore, adjustment value of standard angle is set as 1/6.

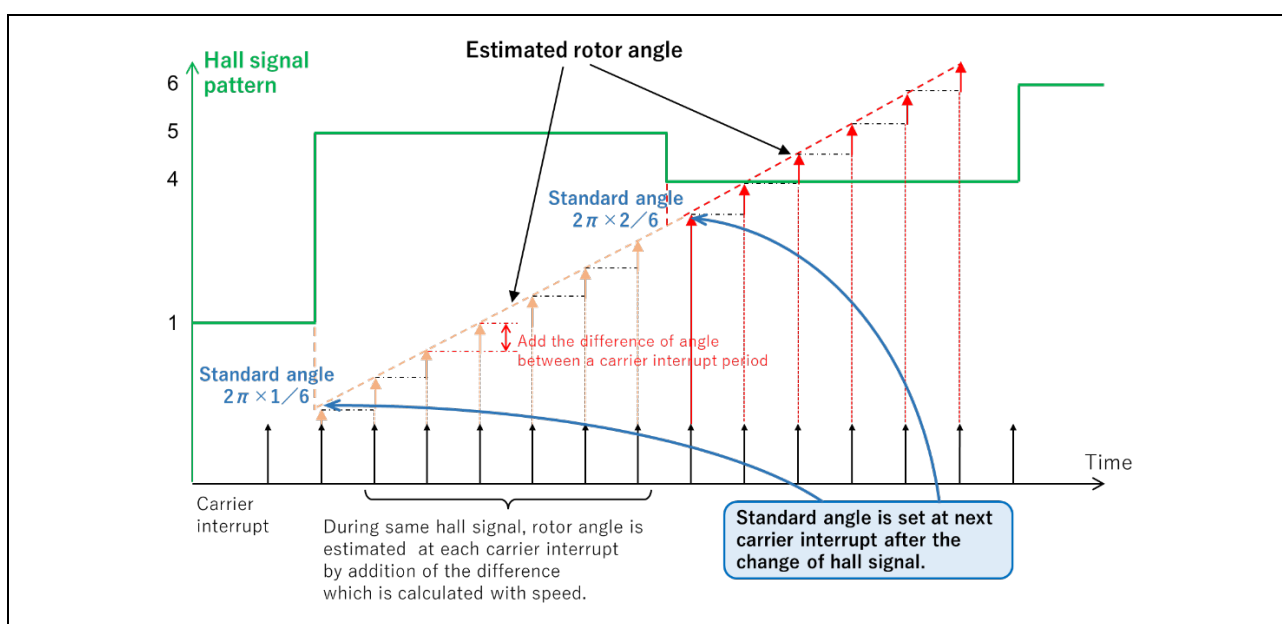

Figure 3-5 Concept of estimation of internal angle during hall signal (clockwise)

Internal angle means fixed angle at the boundary of hall signal change. It is defined as “ $-2\pi/12$ ” at clockwise rotation, as “ $2\pi/12$ ” at counterclockwise rotation. At each carrier interrupt, the difference of angle calculated with the rotational speed is added at clockwise, decreased at counterclockwise. The difference is limited $-2\pi/12$ to $2\pi/12$ with consideration about an error and speed change.

— At clockwise rotation

Internal angle in same hall signal [rad]

$$= \text{Defined value } (-2\pi/12) + \text{estimated speed (rad/sec)} * \text{carrier interrupt period}(50\mu\text{sec}) * \text{Number of carrier interrupt}$$

— At counterclockwise rotation

Internal angle in same hall signal [rad]

$$= \text{Defined value } (2\pi/12) - \text{estimated speed (rad/sec)} * \text{carrier interrupt period}(50\mu\text{sec}) * \text{Number of carrier interrupt}$$

At each case, calculated angle is limited from $-2\pi/12$ to $2\pi/12$.

At the point B in Figure 3-3, hall signal changes 5 to 4. Therefore, the rotor angle is set as below according to Table 3-5.

$$\text{Rotor angle (rad)} = 2\pi * 2/6 + \text{internal angle (rad)} + \text{offset (rad)}$$

At the point C in Figure 3-4, hall signal changes 1 to 3. Therefore, the direction of rotation can be detected as counterclockwise. And the rotor angle is set as below according to Table 3-5.

$$\text{Rotor angle (rad)} = 2\pi * 5/6 + \text{internal angle (rad)} + \text{offset (rad)}$$

At the point D in Figure 3-4, hall signal changes 3 to 2. Therefore, the rotor angle is set as below according to Table 3-5.

$$\text{Rotor angle (rad)} = 2\pi * 4/6 + \text{internal angle (rad)} + \text{offset (rad)}$$

3.1.6 Start-up method

Figure 3-6 shows startup control of vector control software. Immediately after starting, the motor is driven with the q-axis current command value by speed control.

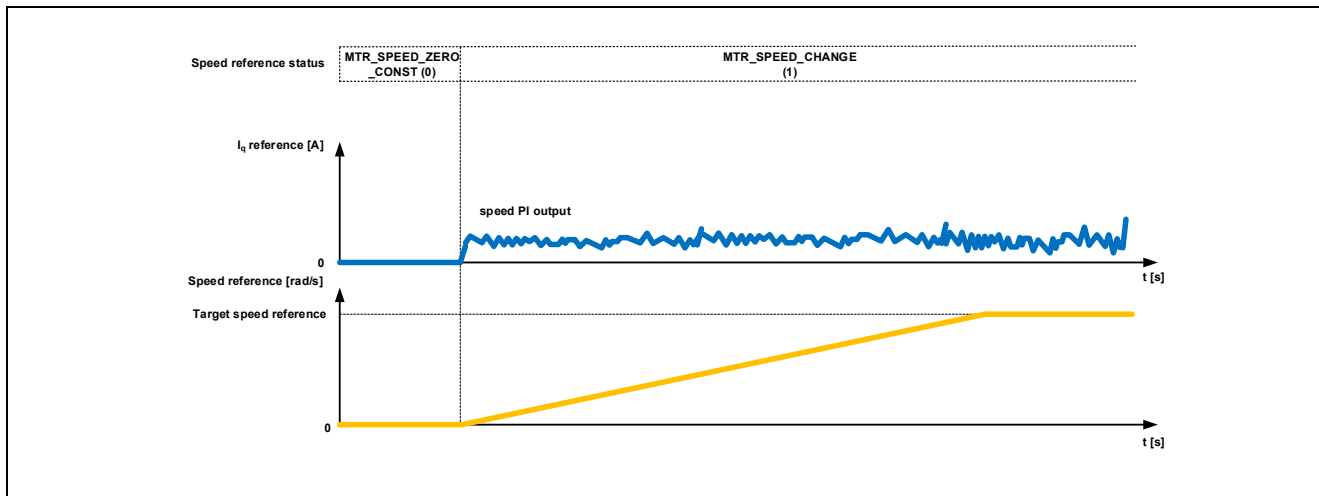

Figure 3-6 Startup control of vector control software

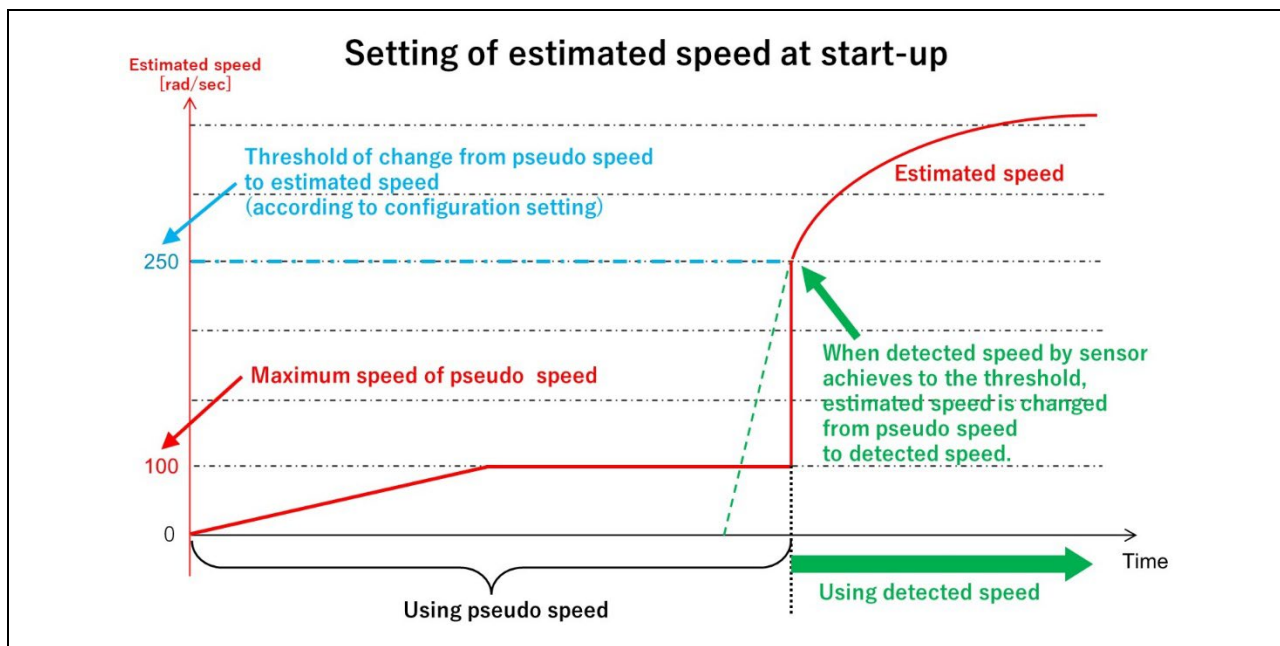

Figure 3-7 Concept of using pseudo speed

However, the rotational speed cannot be detected correctly until the data of one rotation (2π) is gotten. Therefore, pseudo speed, that is increased with a step, is used until the rotation becomes stable to perform smart startup.

The stability of rotation is judged by the set threshold ($f4_start_speed_rad$) in configuration. When detected speed by hall sensors achieves to the threshold, estimated speed is changed to detected speed. Before the timing, pseudo speed is used as estimated speed.

3.1.7 System protection function

This control software has the following error status and executes emergency stop functions in case of occurrence of respective errors. Table 3-6 shows each software threshold for the system protection function.

- Over current error**
 The PWM output ports are set to high impedance state in response to an emergency stop signal (over current detection) from the hardware.
 In addition, U, V, and W phase currents are monitored in over current monitoring cycle. When an over current (when the current exceeds the over current limit) is detected, the CPU executes emergency stop (software detection).
- Over voltage error**
 The inverter bus voltage is monitored in over voltage monitoring cycle. When an over voltage is detected (when the voltage exceeds the over voltage limit), the CPU performs emergency stop. Here, the over voltage limit is set in consideration of the error of resistance value of the detect circuit.
- Low voltage error**
 The inverter bus voltage is monitored in low-voltage monitoring cycle. The CPU performs emergency stop when low voltage (when voltage falls below the limit) is detected. Here, the low voltage limit is set in consideration of the error of resistance value of the detect circuit.
- Over speed error**
 The rotation speed is monitored in rotation speed monitoring cycle. The CPU performs emergency stop when the speed is over the limit.

Table 3-6 Setting values of the system protection function

Error name	Threshold		Monitoring cycle
	Unit	Value	
Over current error	Over current limit [A]	3.54	Current control
Over voltage error	Over voltage limit [V]	60	Current control
Low voltage error	Low voltage limit [V]	8	Current control
Over speed error	Speed limit [rpm]	4500	Current control

3.1.8 AD triggers

Shows the timing of AD triggers and scan groups.

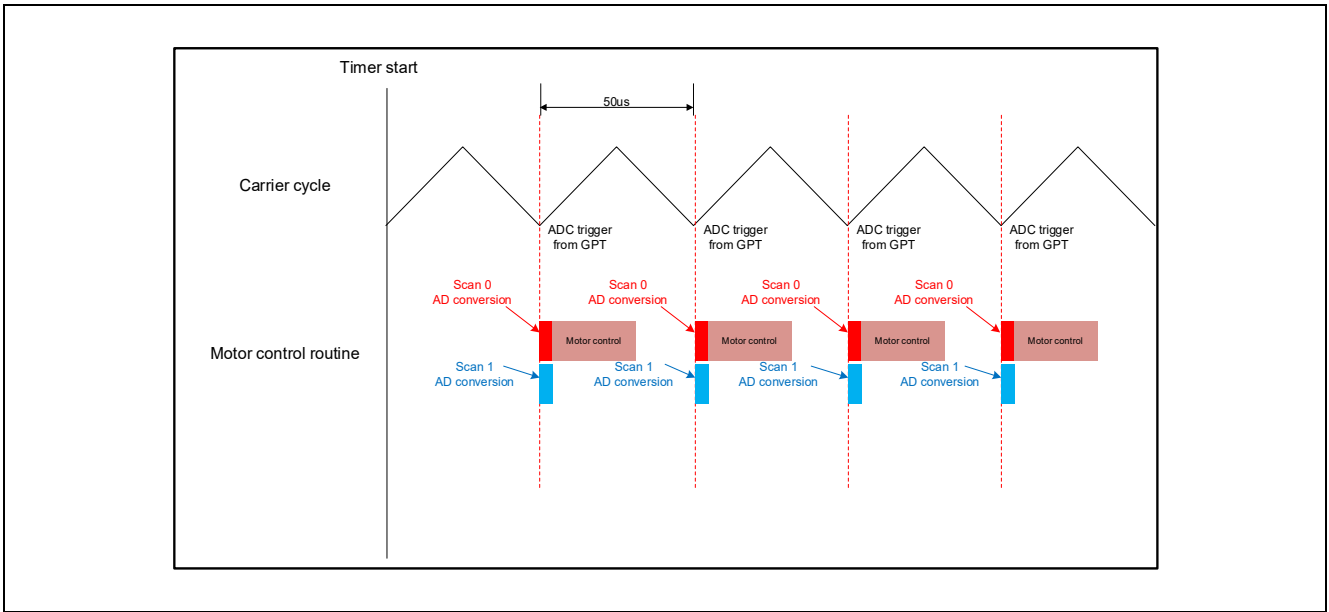

Figure 3-8 AD trigger timing

3.2 Function Specifications of Hall Sensor Vector Control Software

The block diagram of vector control with hall sensors is shown below.

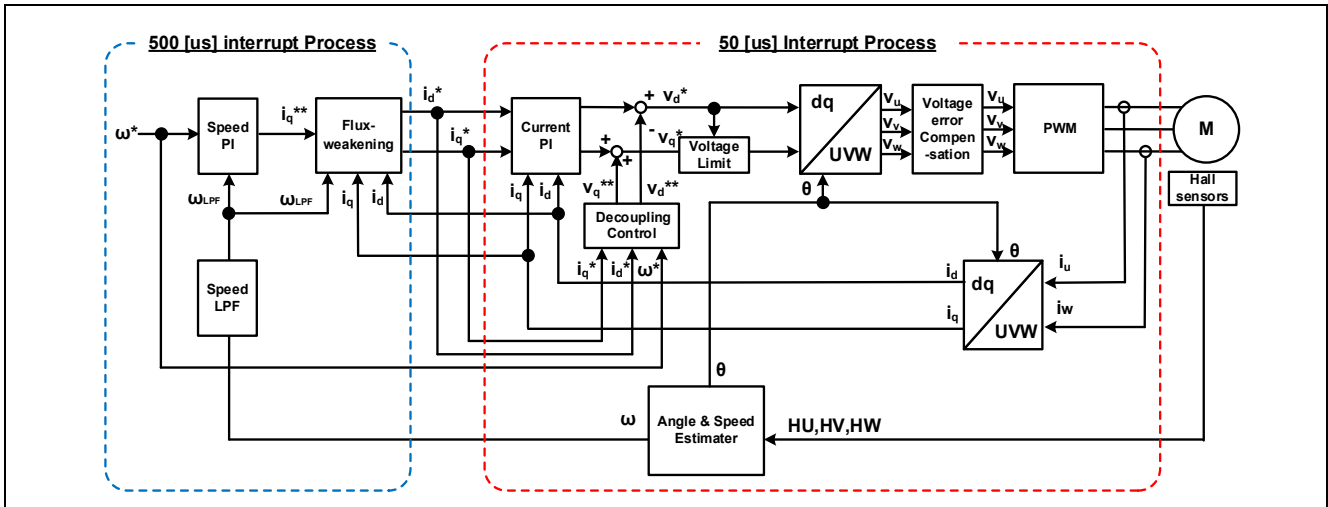

Figure 3-9 Block diagram of vector control with hall sensors

3.3 List of functions

Table 3-7 List of functions executed in current control interrupt (1/5)

File name	Function name	Process overview
mtr_main.c	mtr_callback_event Input : (motor_callback_args_t *) p_args / Callback argument Output : None	Vector control with hall sensors callback function
rm_motor_hall.c	rm_motor_hall_current_callback Input :(motor_current_callback_args_t *) p_args / Callback argument Output : None	Set the speed control output to the current control input
	RM_MOTOR_HALL_ErrorCheck Input :(motor_ctrl_t * const) p_ctrl / Pointer to control structure (uint16_t * const) p_error / Pointer to get occurred error Output : fsp_err_t / Execution result	Check the occurrence of error
	rm_motor_hall_copy_speed_current Input :(motor_speed_output_t *) st_output / Speed control output (motor_current_input_t *) st_input / Current control input Output : None	Copy speed output data to current input data

Table 3-8 List of functions executed in current control interrupt (2/5)

File name	Function name	Process overview
rm_motor_driver.c	rm_motor_driver_cyclic Input :(adc_callback_args_t *) p_args / Callback argument Output : None	Motor driver callback function
	rm_motor_driver_current_get Input :(motor_driver_instance_ctrl_t *) p_ctrl / Pointer to motor driver instance Output : None	Get A/D converted data (phase current & main line voltage)
	RM_MOTOR_DRIVER_FlagCurrentOffsetGet Input :(motor_driver_ctrl_t * const) p_ctrl / Pointer to control structure (uint8_t * const) p_flag_offset / Flag of finish current offset detection Output : fsp_err_t / Execution result	Measure current offset values
	RM_MOTOR_DRIVER_PhaseVoltageSet Input : (motor_driver_ctrl_t * const) p_ctrl / Pointer to control structure (float const) u_voltage / U phase voltage (float const) v_voltage / V phase voltage (float const) w_voltage / W phase voltage Output : fsp_err_t / Execution result	Set phase voltage data to calculate PWM duty.
	rm_motor_driver_modulation Input : (motor_driver_instance_ctrl_t *) p_ctrl / Pointer to motor driver instance Output : None	Perform PWM modulation
	rm_motor_driver_mod_run Input : (motor_driver_instance_ctrl_t *) p_ctrl / Pointer to motor driver instance (const float *) p_f4_v_in / Pointer to 3-phase input voltage (float *) p_f4_duty_out / Where to store the 3-phase output duty cycle Output : None	Calculates duty cycle from input 3-phase voltage (bipolar)
	rm_motor_driver_set_uvw_duty Input : (motor_driver_instance_ctrl_t *) p_ctrl / Pointer to motor driver instance (float) f_duty_u / Duty cycle of phase-U (float) f_duty_v / Duty cycle of phase-V (float) f_duty_w / Duty cycle of phase-W Output : None	PWM duty setting
	RM_MOTOR_DRIVER_CurrentGet Input : (motor_driver_ctrl_t * const) p_ctrl / Pointer to control structure (motor_driver_current_get_t * const) p_current_get / Pointer to get data structure Output : fsp_err_t / Execution result	Get calculated phase current, Vdc & Va_max data

Table 3-9 List of functions executed in current control interrupt (3/5)

File name	Function name	Process overview
rm_motor_current.c	rm_motor_current_cyclic Input : (motor_driver_callback_args_t *) p_args / Callback argument Output : None	Current control cycle operation
	RM_MOTOR_CURRENT_ParameterSet Input : (motor_current_ctrl_t * const) p_ctrl / Pointer to control structure (motor_current_input_t const * const) p_st_input / Pointer to input current structure Output : fsp_err_t / Execution result	Set (input) parameter data.
	RM_MOTOR_CURRENT_CurrentSet Input : (motor_current_ctrl_t * const) p_ctrl / Pointer to control structure (motor_current_input_current_t const * const) p_st_current / Pointer to input current structure (motor_current_input_voltage_t const * const) p_st_voltage / Pointer to input voltage structure Output : fsp_err_t / Execution result	Set d/q-axis current & voltage data.
	RM_MOTOR_CURRENT_CurrentGet Input : (motor_current_ctrl_t * const) p_ctrl / Pointer to control structure (float * const) p_id / Pointer to get d-axis current (float * const) p_iq / Pointer to get q-axis current Output : fsp_err_t / Execution result	Get d/q-axis current
	motor_current_transform_uv_w_dq_abs Input : (const float) f_angle / Rotor angle (const float *) f_uv_w / Pointer to UVW-phase array in [U,V,W] format (float *) f_dq / Where to store [d,q] formatted array on dq coordinates Output : None	Coordinate transform UVW to dq (absolute transform)

Table 3-10 List of functions executed in current control interrupt (4/5)

File name	Function name	Process overview
rm_motor_current.c	motor_current_angle_cyclic Input : (motor_current_instance_t *) p_instance / Pointer to current control module control instance Output : None	Angle/speed process in cyclic process of current control
	RM_MOTOR_CURRENT_SpeedPhaseSet Input : (motor_current_ctrl_t * const) p_ctrl / Pointer to control structure (float const) speed / Rotational speed (float const) phase / Rotor phase Output : fsp_err_t / Execution result	Set current speed & rotor phase data
	RM_MOTOR_CURRENT_CurrentReferenceSet Input : (motor_current_ctrl_t * const) p_ctrl / Pointer to control structure (float const) id_reference / D-axis current Reference (float const) iq_reference / Q-axis current Reference Output : fsp_err_t / Execution result	Set current reference data
	RM_MOTOR_CURRENT_PhaseVoltageGet Input : (motor_current_ctrl_t * const) p_ctrl / Pointer to control structure (motor_current_get_voltage_t * const) p_voltage / Pointer to get voltages Output : fsp_err_t / Execution result	Gets the set phase voltage
	motor_current_pi_calculation Input : (motor_current_instance_ctrl_t *) p_instance / Pointer to FOC current control structure Output : None	Calculates output voltage vector from current vector command and actual current vector
	motor_current_pi_control Input : (motor_current_pi_params_t *) pi_ctrl / Pointer to PI control structure Output : float / PI control output value	PI control
	motor_current_limit_abs Input : (float) f4_value / Target value (float) f4_limit_value / Limit Output : float / Limited value	Limit with absolute value
	motor_current_decoupling Input : (motor_current_instance_ctrl_t *) p_ctrl / Pointer to FOC current control instance (float) f_speed_rad / Electrical speed (const motor_current_motor_parameter_t *) p_mtr / Pointer to motor parameter data structure Output : None	Decoupling control
	motor_current_voltage_limit Input : (motor_current_instance_ctrl_t *) p_ctrl / Pointer to FOC current control structure Output : None	Limit voltage vector

Table 3-11 List of functions executed in current control interrupt (5/5)

File name	Function name	Process overview
rm_motor_current.c	motor_current_transform_dq_uvuw_abs Input : (const float) f_angle / Rotor angle (const float *) f_dq / Pointer to dq-axis value array in [D,Q] format (float *) f_uvuw / Where to store [U,V,W] formatted 3-phase quantities array Output : None	Coordinate transform dq to UVW 3-phase (absolute transform)
librm_motor_current.a	rm_motor_voltage_error_compensation_main Input : (motor_currnt_voltage_compensation_t *) st_volt_comp / Voltage error compensation data (float *) p_f4_v_array / Reference voltage (float *) p_f4_i_array / Reference current (float) f4_vdc / Bus voltage Output : None	Voltage error compensation
rm_motor_sense_hall.c	RM_MOTOR_SENSE_HALL_FlagPiCtrlSet Input : (motor_angle_ctrl_t * const) p_ctrl / Pointer to control structure (uint32_t const) flag_pi / The flag of PI control runs Output : fsp_err_t / Execution result	Set the flag of PI Control runs.
	RM_MOTOR_SENSE_HALL_SpeedSet Input : (motor_angle_ctrl_t * const) p_ctrl / Pointer to control structure (float const) speed_ctrl / Reference speed (float const) damp_speed / damping speed (no use) Output : fsp_err_t / Execution result	Set speed information.
	RM_MOTOR_SENSE_HALL_AngleSpeedGet Input : (motor_angle_ctrl_t * const) p_ctrl / Pointer to control structure (float * const) p_angle / Memory address to get rotor angle data (float * const) p_speed / Memory address to get rotational speed data (float * const) p_phase_err / Memory address to get phase(angle) error data Output : fsp_err_t / Execution result	Gets the current rotor's angle and rotation speed. (phase error data is invalid.)
r_gpt_three_phase.c	R_GPT_THREE_PHASE_DutyCycleSet Input : (three_phase_ctrl_t * const) p_ctrl / Control block set in @ref three_phase_api_t::open call for this timer (three_phase_duty_cycle_t * const) p_duty_cycle / Duty cycle values for all three timer channels Output : fsp_err_t / Execution result	Sets duty cycle for all three timers

Table 3-12 List of functions executed in speed control interrupt (1/3)

File name	Function name	Process overview
mtr_main.c	mtr_callback_event Input : motor_callback_args_t * p_args / Callback argument Output : None	Vector control with hall sensors callback function
	get_vr1 Input : None Output : uint16_t / Conversion value	Get VR1 A/D conversion value
rm_motor_current.c	RM_MOTOR_CURRENT_ParameterGet Input : (motor_current_ctrl_t * const) p_ctrl / Pointer to control structure (motor_current_output_t const * const) p_st_output / Pointer to input current data Output : fsp_err_t / Execution result	Set (input) parameter data
rm_motor_hall.c	rm_motor_hall_speed_callback Input : (motor_speed_callback_args_t *) p_args / Callback argument Output : None	Speed control callback function
	rm_motor_hall_copy_current_speed Input : (motor_current_output_t *) st_output / Pointer to structure of current control output (motor_speed_input_t *) st_input / Pointer to structure of speed control input Output : None	Copy current output data to speed input data

Table 3-13 List of functions executed in speed control interrupt (2/3)

File name	Function name	Process overview
rm_motor_speed.c	rm_motor_speed_cyclic Input : (timer_callback_args_t *) p_args / Callback argument Output : None	Cyclic process of speed control (Call at timer interrupt)
	RM_MOTOR_SPEED_ParameterSet Input : (motor_speed_ctrl_t * const) p_ctrl / Pointer to control structure (motor_speed_input_t const * const) p_st_input / Pointer to structure of speed input parameters Output : fsp_err_t / Execution result	Set speed Input parameters
	RM_MOTOR_SPEED_SpeedControl Input : (motor_speed_ctrl_t * const) p_ctrl / Pointer to control structure Output : fsp_err_t / Execution result	Calculates the d/q-axis current reference. (Main process of Speed Control)
	rm_motor_speed_set_speed_ref_hall Input : (motor_speed_instance_ctrl_t *) p_ctrl / Pointer to FOC data instance Output : float / Reference speed	Updates the speed reference
	rm_motor_speed_set_iq_ref_hall Input : (motor_speed_instance_ctrl_t *) p_ctrl / Pointer to control instance Output : float / Iq reference	Updates the q-axis current reference
	rm_motor_speed_set_id_ref_hall Input : (motor_speed_instance_ctrl_t *) p_ctrl / Pointer to control instance Output : float / Id reference	Updates the d-axis current reference
	RM_MOTOR_SPEED_ParameterGet Input : (motor_speed_ctrl_t * const) p_ctrl / Pointer to motor speed control block (motor_speed_output_t * const) p_st_output / Pointer to get speed control parameters Output : fsp_err_t / Execution result	Get speed control output parameters

Table 3-14 List of functions executed in speed control interrupt (3/3)

File name	Function name	Process overview
librm_motor_speed.a	rm_motor_speed_first_order_lpf Input : (motor_speed_lpf_t *) p_lpf / Pointer to first order LPF structure (float) f_input / Input data Output : float / Filtered data	First order LPF
	rm_motor_speed_fluxwkn_set_vamax Input : (motor_speed_flux_weakening_t *) p_fluxwkn / Pointer to flux weakening structure (float) f4_va_max / maximum magnitude of voltage vector Output : None	Sets the maximum magnitude of voltage vector
	rm_motor_speed_fluxwkn_run Input : (motor_speed_flux_weakening_t *) p_fluxwkn / Pointer to flux weakening structure (float) f4_speed_rad / Electrical speed of motor (const float *) p_f4_idq / Pointer to the measured current vector in format d/q (float *) p_f4_idq_ref / Pointer to reference current vector in format d/q Output : None	Executes the flux-weakening module

3.4 Contents of Control

3.4.1 Configuration options

The configuration options of the hall sensor vector control module for motor can be configured using the RA Configurator. The changed options are automatically reflected to the `hal_data.h` and `rm_motor_hall.h` when generating code. The option names and setting values are listed in the shown as follows.

Table 3-15 Configuration options(`rm_motor_hall.h`)

Options	Description
Limit of over current (A)	When a phase current exceeds this value, PWM output ports are set to off.
Limit of over voltage (V)	When an inverter voltage exceeds this value, PWM output ports are set to off.
Limit of over speed (rpm)	When a rotation speed exceeds this value, PWM output ports are set to off.
Limit of low voltage (V)	When an inverter voltage becomes below this value, PWM output ports are set to off.

Table 3-16 Configuration options(`rm_motor_hall.h`)

Options	RA6T2	RA4T1	RA6T3	RA8T1
Limit of over current (A)	1.67	1.67	1.67	1.67
Limit of over voltage (V)	60.0	60.0	60.0	60.0
Limit of over speed (rpm)	4500.0	4500.0	4500.0	4500.0
Limit of low voltage (V)	8.0	8.0	8.0	8.0

3.4.2 Configuration Options for included modules

The hall sensor vector control module for motor includes below modules.

- Current Module
- Speed Module
- Angle Module
- Driver Module

And these included modules also have each configuration parameters as same as the vector control with hall sensor module. The option names and setting values are listed in the tables shown as follows.

Table 3-17 Configuration options (rm_motor_current.h)

Options	Description
General Shunt type	Selects how many shunt resistances to use current detection.
General Current control decimation	Counts of decimation about carrier interrupt
General PWM carrier frequency (kHz)	PWM carrier frequency [kHz]
General Input voltage (V)	Input voltage [V]
General Sample delay compensation	Selects whether to “enable” or “disable” sample delay compensation
General Period magnification value	Period magnification value for sampling delay compensation.
General Voltage error compensation	Selects whether to “enable” or “disable” voltage error compensation.
General Voltage error compensation table of voltage 1	Table of voltage error compensation about voltage #1
General Voltage error compensation table of voltage 2	Table of voltage error compensation about voltage #2
General Voltage error compensation table of voltage 3	Table of voltage error compensation about voltage #3
General Voltage error compensation table of voltage 4	Table of voltage error compensation about voltage #4
General Voltage error compensation table of voltage 5	Table of voltage error compensation about voltage #5
General Voltage error compensation table of current 1	Table of voltage error compensation about current #1
General Voltage error compensation table of current 2	Table of voltage error compensation about current #2
General Voltage error compensation table of current 3	Table of voltage error compensation about current #3
General Voltage error compensation table of current 4	Table of voltage error compensation about current #4
General Voltage error compensation table of current 5	Table of voltage error compensation about current #5
Design Parameter Current PI loop omega	Current PI control omega parameter [Hz].
Design Parameter Current PI loop zeta	Current PI control zeta parameter.
Motor Parameter Pole pairs	Pole pairs of target motor.
Motor Parameter Resistance (ohm)	Resistance of motor [ohm].
Motor Parameter Inductance of d-axis (H)	D-axis inductance [H].
Motor Parameter Inductance of q-axis (H)	Q-axis inductance [H].
Motor Parameter Permanent magnetic flux (Wb)	Magnetic flux [Wb].
Motor Parameter Rotor inertia (kgm ²)	Rotor inertia [kgm ²].

Table 3-18 Configuration Options initial value (rm_motor_current.h)

Options	RA6T2	RA4T1	RA6T3	RA8T1
General Shunt type	2shunt	2shunt	2shunt	2shunt
General Current control decimation	0	1	0	0
General PWM carrier frequency (kHz)	20.0	20.0	20.0	20.0
General Input voltage (V)	24.0	24.0	24.0	24.0
General Sample delay compensation	Enable	Disable	Disable	Disable
General Period magnification value	1.5	1.5	1.5	1.5
General Voltage error compensation	Enable	Enable	Enable	Enable
General Voltage error compensation table of voltage 1	0.477	0.477	0.477	0.477
General Voltage error compensation table of voltage 2	0.742	0.742	0.742	0.742
General Voltage error compensation table of voltage 3	0.892	0.892	0.892	0.892
General Voltage error compensation table of voltage 4	0.979	0.979	0.979	0.979
General Voltage error compensation table of voltage 5	1.009	1.009	1.009	1.009
General Voltage error compensation table of current 1	0.021	0.021	0.021	0.021
General Voltage error compensation table of current 2	0.034	0.034	0.034	0.034
General Voltage error compensation table of current 3	0.064	0.064	0.064	0.064
General Voltage error compensation table of current 4	0.158	0.158	0.158	0.158
General Voltage error compensation table of current 5	0.400	0.400	0.400	0.400
Design Parameter Current PI loop omega	300.0	300.0	300.0	300.0
Design Parameter Current PI loop zeta	1.0	1.0	1.0	1.0
Motor Parameter Pole pairs	4	4	4	4
Motor Parameter Resistance (ohm)	1.3	1.3	1.3	1.3
Motor Parameter Inductance of d-axis (H)	0.0013	0.0013	0.0013	0.0013
Motor Parameter Inductance of q-axis (H)	0.0013	0.0013	0.0013	0.0013
Motor Parameter Permanent magnetic flux (Wb)	0.01119	0.01119	0.01119	0.01119
Motor Parameter Rotor inertia (kgm ²)	0.000003666	0.000003666	0.000003666	0.000003666

Table 3-19 Configuration options (rm_motor_speed.h)

Options	Description
Common Position support	Support position control
General Speed control period (sec)	The period of speed control process [sec].
General Step of speed climbing (rpm)	The step of speed fluctuation [rpm]. Program controls speed by this step at acceleration and deceleration.
General Maximum rotational speed (rpm)	Maximum rotational speed [rpm]
General Speed LPF omega	Speed LPF parameter omega [Hz].
General Limit of q-axis current (A)	Limit of q-axis current [A].
General Step of speed feedback at open-loop	Rate of reference speed for feedback speed limiter at Open-Loop.
General Natural frequency	Natural frequency for disturbance speed observer.
General Open-loop damping	Select enable/disable of damping control at Open-Loop.
General Flux weakening	Select enable/disable of flux weakening control at high speed.
General Torque compensation for sensorless transition	Select enable/disable of soft switching at the transition from Open-Loop to PI control.
General Speed observer	Select enable/disable of speed observer process
General Selection of speed observer	Select the method of speed observer
General Control method	Select the position control method.
Open-Loop Step of d-axis current climbing	The d-axis current reference ramping up rate [A/msec].
Open-Loop Step of d-axis current descending	The d-axis current reference ramping down rate [A/msec].
Open-Loop Step of q-axis current descending ratio	The q-axis current reference ramping down proportion to reference before open-loop [A/msec].
Open-Loop Reference of d-axis current	The d-axis current reference in open-loop drive [A].
Open-Loop Threshold of speed control descending	The speed threshold [rad/s] to ramp down the d-axis current [rpm].
Open-Loop Threshold of speed control climbing	The speed threshold [rad/s] to ramp up the d-axis current [rpm].
Open-Loop Period between open-loop to BEMF (sec)	Time to switch open-loop to sensor-less [sec].
Open-Loop Phase error(degree) to decide sensor-less switch timing	Phase error to decide sensor-less switch timing (electrical angle) [degree].
Design parameter Speed PI loop omega	Speed PI Control parameter omega.
Design parameter Speed PI loop zeta	Speed PI Control parameter zeta.
Design parameter Estimated d-axis HPF omega	Natural frequency [Hz] for HPF in open-loop damping gain design.
Design parameter Open-loop damping zeta	Damping ratio for open-loop damping gain design.
Design parameter Cutoff frequency of phase error LPF	The cut-off frequency [Hz] of phase error LPF gain design.
Design parameter Speed observer omega	Speed observer omega.
Design parameter Speed observer zeta	Speed observer zeta.
Motor Parameter Pole pairs	Pole pairs of target motor.
Motor Parameter Resistance (ohm)	Resistance of motor [ohm].
Motor Parameter Inductance of d-axis (H)	D-axis inductance [H].
Motor Parameter Inductance of q-axis (H)	Q-axis inductance [H].
Motor Parameter Permanent magnetic flux (Wb)	Magnetic flux [Wb].
Motor Parameter Rotor inertia (kgm ²)	Rotor inertia [kgm ²].

Table 3-20 Configuration Options initial value (rm_motor_speed.h)

Options	RA6T2	RA4T1	RA6T3	RA8T1
Common Position support	-	-	-	-
General Speed control period (sec)	0.0005	0.001	0.0005	0.0005
General Step of speed climbing (rpm)	0.5	0.5	0.5	0.5
General Maximum rotational speed (rpm)	2400.0	2400.0	2400.0	2400.0
General Speed LPF omega	10.0	10.0	10.0	10.0
General Limit of q-axis current (A)	1.67	1.67	1.67	1.67
General Step of speed feedback at open-loop	0.2	0.2	0.2	0.2
General Natural frequency	100.0	100.0	100.0	100.0
General Open-loop damping	Disable	Disable	Disable	Disable
General Flux weakening	Disable	Disable	Disable	Disable
General Torque compensation for sensorless transition	Disable	Disable	Disable	Disable
General Speed observer	Disable	Disable	Disable	Disable
General Selection of speed observer	Normal	Normal	Normal	Normal
General Control method	-	-	-	-
Open-Loop Step of d-axis current climbing	0.3	0.3	0.3	0.3
Open-Loop Step of d-axis current descending	0.3	0.3	0.3	0.3
Open-Loop Step of q-axis current descending ratio	1.0	1.0	1.0	1.0
Open-Loop Reference of d-axis current	0.3	0.3	0.3	0.3
Open-Loop Threshold of speed control descending	500	500	500	500
Open-Loop Threshold of speed control climbing	400	400	400	400
Open-Loop Period between open-loop to BEMF (sec)	0.025	0.025	0.025	0.025
Open-Loop Phase error(degree) to decide sensor-less switch timing	10	10	10	10
Design parameter Speed PI loop omega	5.0	5.0	5.0	5.0
Design parameter Speed PI loop zeta	1.0	1.0	1.0	1.0
Design parameter Estimated d-axis HPF omega	2.5	2.5	2.5	2.5
Design parameter Open-loop damping zeta	-	-	-	-
Design parameter Cutoff frequency of phase error LPF	10.0	10.0	10.0	10.0
Design parameter Speed observer omega	-	-	-	-
Design parameter Speed observer zeta	-	-	-	-
Motor Parameter Pole pairs	4	4	4	4
Motor Parameter Resistance (ohm)	1.3	1.3	1.3	1.3
Motor Parameter Inductance of d-axis (H)	0.0013	0.0013	0.0013	0.0013
Motor Parameter Inductance of q-axis (H)	0.0013	0.0013	0.0013	0.0013
Motor Parameter Permanent magnetic flux (Wb)	0.01119	0.01119	0.01119	0.01119
Motor Parameter Rotor inertia (kgm ²)	0.000003666	0.000003666	0.000003666	0.000003666

Table 3-21 Configuration options (rm_motor_sense_hall.h)

Options	Description
Hall sensor U phase input port	Input port of U phase hall sensor
Hall sensor V phase input port	Input port of V phase hall sensor
Hall sensor W phase input port	Input port of W phase hall sensor
Hall sensor sensor pattern #1	Hall sensor sensor pattern #1
Hall sensor sensor pattern #2	Hall sensor sensor pattern #2
Hall sensor sensor pattern #3	Hall sensor sensor pattern #3
Hall sensor sensor pattern #4	Hall sensor sensor pattern #4
Hall sensor sensor pattern #5	Hall sensor sensor pattern #5
Hall sensor sensor pattern #6	Hall sensor sensor pattern #6
PMW Carrier Frequency (kHz)	Carrier Frequency [kHz]
Correction parameter of rotor angle	Angle correction value
Default counts of carrier interrupt	Number of carrier interrupt measurements
Maximum counts of one rotation	Maximum number of measurements between Hall sensor signals
Target value for pseudo speed (rad/s)	Target value for pseudo speed [rad/sec]
Target time until the pseudo speed update reaches (msec)	Pseudo speed increases until this time.
Rotation counts to start speed estimation	After this rotation counts of the motor, estimation of speed process starts to work.
Carrier counts at startup	Initial carrier counts at motor start up to calculate speed.
Speed to judge start	Speed to judge start PI calculation

Table 3-22 Configuration Options initial value (rm_motor_sense_hall.h)

Options	RA6T2	RA4T1	RA6T3	RA8T1
Hall sensor U phase input port	BSP_IO_PORT _12_PIN_04	BSP_IO_PORT _00_PIN_08	BSP_IO_PORT _00_PIN_08	BSP_IO_PORT _09_PIN_07
Hall sensor V phase input port	BSP_IO_PORT _12_PIN_05	BSP_IO_PORT _00_PIN_06	BSP_IO_PORT _00_PIN_06	BSP_IO_PORT _09_PIN_05
Hall sensor W phase input port	BSP_IO_PORT _11_PIN_01	BSP_IO_PORT _00_PIN_15	BSP_IO_PORT _00_PIN_15	BSP_IO_PORT _09_PIN_06
Hall sensor sensor pattern #1	1	1	1	1
Hall sensor sensor pattern #2	5	5	5	5
Hall sensor sensor pattern #3	4	4	4	4
Hall sensor sensor pattern #4	6	6	6	6
Hall sensor sensor pattern #5	2	2	2	2
Hall sensor sensor pattern #6	3	3	3	3
PWM Carrier Frequency	20.0	10.0	20.0	20.0
Correction parameter of rotor angle	0.4	0.4	0.4	0.4
Default counts of carrier interrupt	300	300	300	300
Maximum counts of one rotation	500	500	500	500
Target value for pseudo speed (rad/s)	100.0	100.0	100.0	100.0
Target time until the pseudo speed update reaches (msec)	300.0	600.0	300.0	300.0
Rotation counts to start speed estimation	2	2	2	2
Carrier counts at startup	400	400	400	400
Speed to judge start	250.0	250.0	250.0	250.0

Table 3-23 Configuration options (rm_motor_driver.h)

Options	Description
Common ADC_B Support	ADC_B module support
Common Shared ADC support	Selection of using shared ADC module
Common Supported Motor Number	Number of driven motors
General Shunt type	Current detection method selection
General Modulation method	Selection of the method of modulation
General PWM output port UP	Port setting of U phase upper arm
General PWM output port UN	Port setting of U phase lower arm
General PWM output port VP	Port setting of V phase upper arm
General PWM output port VN	Port setting of V phase lower arm
General PWM output port WP	Port setting of W phase upper arm
General PWM output port WN	Port setting of W phase lower arm
General PWM Timer Frequency (MHz)	PWM Timer Clock Frequency [MHz]
General PWM Carrier Period (Microseconds)	PWM Carrier Period [Micro seconds]
General Dead Time (Raw Counts)	PWM Dead time [raw counts]
General Current Range (A)	Measurement Range of Electric current [A]
General Voltage Range (V)	Measurement Range of Inverter Voltage [V]
General Counts for current offset measurement	Counts of measurement the offset of A/D Conversion at electric current input.
General A/D conversion channel for U Phase current	A/D channel for U-phase current
General A/D conversion channel for W Phase current	A/D channel for W-phase current
General A/D conversion channel for Main Line Voltage	A/D channel for main line voltage
General A/D conversion channel for V Phase current	A/D channel for V-phase current
General A/D conversion channel for sin signal	A/D channel for sin signal
General A/D conversion channel for cos signal	A/D channel for cos signal
General Using ADC scan group	Set ADC scan group according to ADC module setting.
General A/D conversion unit for U Phase current	Select the A/D conversion module for U phase current
General A/D conversion unit for W Phase current	Select the A/D conversion module for W phase current
General A/D conversion unit for main line voltage	Select the A/D conversion module for main line voltage
General A/D conversion unit for V Phase current	Select the A/D conversion module for V phase current
General A/D conversion unit for sin signal	Select the A/D conversion module for sin signal
General A/D conversion unit for cos signal	Select the A/D conversion module for cos signal
General ADC interrupt module	Select from which module ADC interrupt happens
General Adjustment value to current A/D	Current A/D timing adjustment (for 1shunt)
General Minimum difference of PWM duty	Minimum difference of PWM duty setting (for 1shunt)
General Adjustment delay of A/D conversion	A/D conversion delay timing adjustment (for 1shunt)
General 1shunt interrupt phase	Which phase is used to detect 1shunt current (for 1shunt)
General Input Voltage (V)	Range of input for main line voltage
General Resolution of A/D conversion	Resolution of A/D conversion Please set same value with ADC module setting.
General Offset of A/D conversion for current	Offset level of A/D conversion input for current Please set according to the circuit.
General Conversion level of A/D conversion for voltage	Conversion level of A/D conversion for voltage Please set when the CPU main voltage is different.
General GTIOCA stop level	Output level of upper arm at stop status
General GTIOCB stop level	Output level of lower arm at stop status
Modulation Maximum duty	Maximum duty of PWM Maximum duty except dead time.

Table 3-24 Configuration Options initial value (rm_motor_driver.h) [1/2]

Options	RA6T2	RA4T1	RA6T3	RA8T1
Common ADC_B Support	Enabled	-	-	-
Common Shared ADC support	Disabled	Disabled	Disabled	Disabled
Common Supported Motor Number	1	1	1	1
General Shunt type	2shunt	2shunt	2shunt	2shunt
General Modulation method	SVPWM	SVPWM	SVPWM	SVPWM
General PWM output port UP	BSP_IO_PORT_11_PIN_04	BSP_IO_PORT_04_PIN_09	BSP_IO_PORT_04_PIN_09	BSP_IO_PORT_01_PIN_15
General PWM output port UN	BSP_IO_PORT_11_PIN_05	BSP_IO_PORT_04_PIN_08	BSP_IO_PORT_04_PIN_08	BSP_IO_PORT_06_PIN_09
General PWM output port VP	BSP_IO_PORT_11_PIN_06	BSP_IO_PORT_01_PIN_03	BSP_IO_PORT_01_PIN_03	BSP_IO_PORT_01_PIN_13
General PWM output port VN	BSP_IO_PORT_11_PIN_07	BSP_IO_PORT_01_PIN_02	BSP_IO_PORT_01_PIN_02	BSP_IO_PORT_01_PIN_14
General PWM output port WP	BSP_IO_PORT_11_PIN_08	BSP_IO_PORT_01_PIN_11	BSP_IO_PORT_01_PIN_11	BSP_IO_PORT_03_PIN_00
General PWM output port WN	BSP_IO_PORT_11_PIN_09	BSP_IO_PORT_01_PIN_12	BSP_IO_PORT_01_PIN_12	BSP_IO_PORT_01_PIN_12
General PWM Timer Frequency (MHz)	120.0	100.0	100.0	120.0
General PWM Carrier Period (Microseconds)	50.0	50.0	50.0	50.0
General Dead Time (Raw Counts)	240	200	240	240
General Current Range (A)	16.5	16.5	16.5	16.5
General Voltage Range (V)	73.26	73.26	73.26	73.26
General Counts for current offset measurement	500	500	500	500
General A/D conversion channel for U Phase current	4	0	0	0
General A/D conversion channel for W Phase current	0	2	2	2
General A/D conversion channel for Main Line Voltage	6	4	4	8
General A/D conversion channel for V Phase current	-	-	-	-
General A/D conversion channel for sin signal	-	-	-	-
General A/D conversion channel for cos signal	-	-	-	-
General Using ADC scan group	0	-	-	-

Table 3-25 Configuration Options initial value (rm_motor_driver.h) [2/2]

Options	RA6T2	RA4T1	RA6T3	RA8T1
General A/D conversion unit for U Phase current	-	0	0	0
General A/D conversion unit for W Phase current	-	0	0	0
General A/D conversion unit for main line voltage	-	0	0	0
General A/D conversion unit for V Phase current	-	-	-	-
General A/D conversion unit for sin signal	-	-	-	-
General A/D conversion unit for cos signal	-	-	-	-
General ADC interrupt module	-	1st	1st	1st
General Adjustment value to current A/D	-	-	-	-
General Minimum difference of PWM duty	-	-	-	-
General Adjustment delay of A/D conversion	-	-	-	-
General 1shunt interrupt phase	-	-	-	-
General Input Voltage (V)	24.0	24.0	24.0	24.0
General Resolution of A/D conversion	0xFFFF	0xFFFF	0xFFFF	0xFFFF
General Offset of A/D conversion for current	0x7FF	0x7FF	0x7FF	0x7FF
General Conversion level of A/D conversion for voltage	1.0	1.0	1.0	1.0
General GTIOCA stop level	Pin Level Low	Pin Level Low	Pin Level Low	Pin Level Low
General GTIOCB stop level	Pin Level High	Pin Level High	Pin Level High	Pin Level High
Modulation Maximum duty	0.9375	0.9375	0.9375	0.9375

3.5 Control flowcharts

3.5.1 Main process

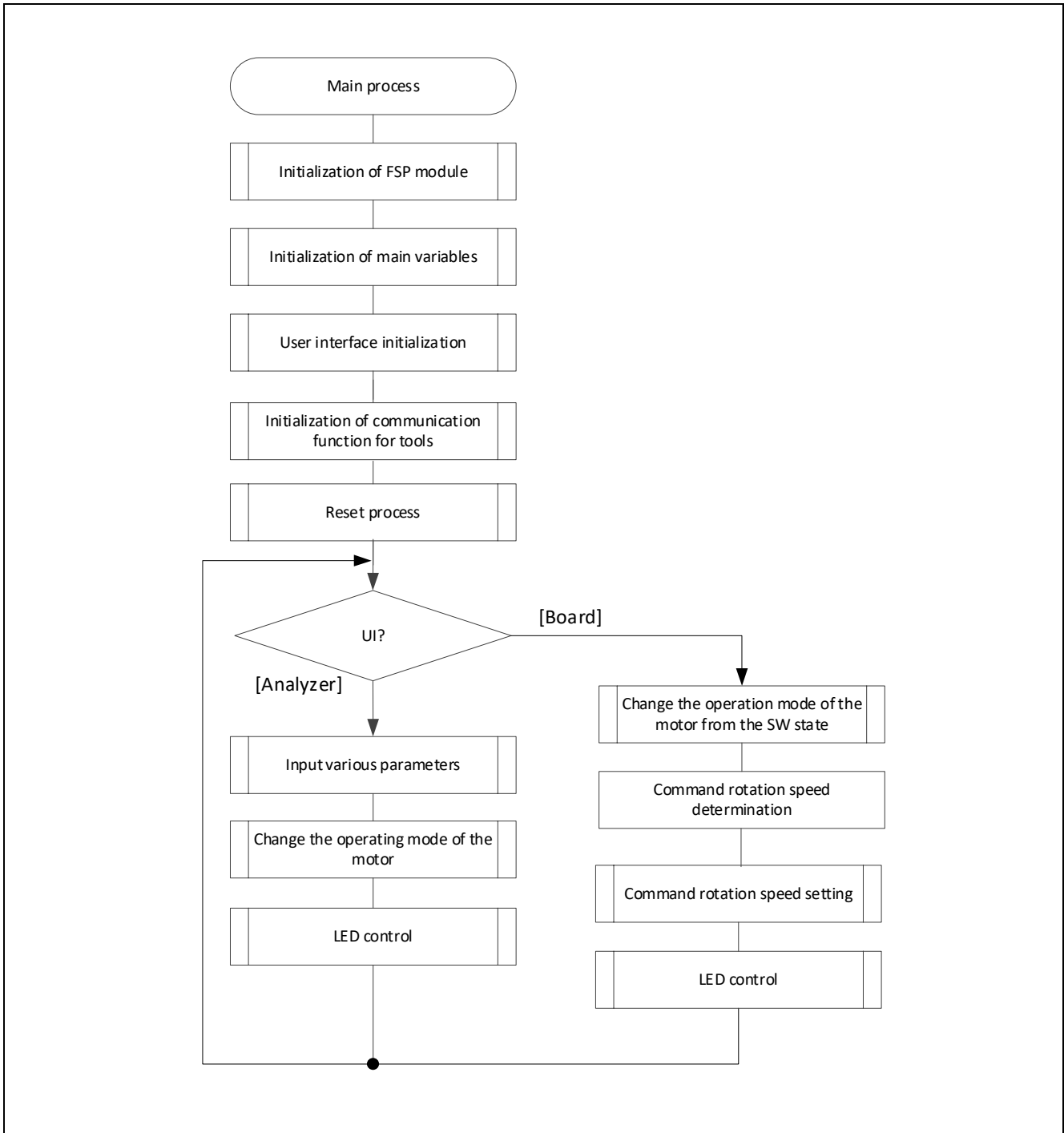

Figure 3-10 Main process flowchart

3.5.2 Current Control Period Interrupt (carrier synchronized interrupt) process

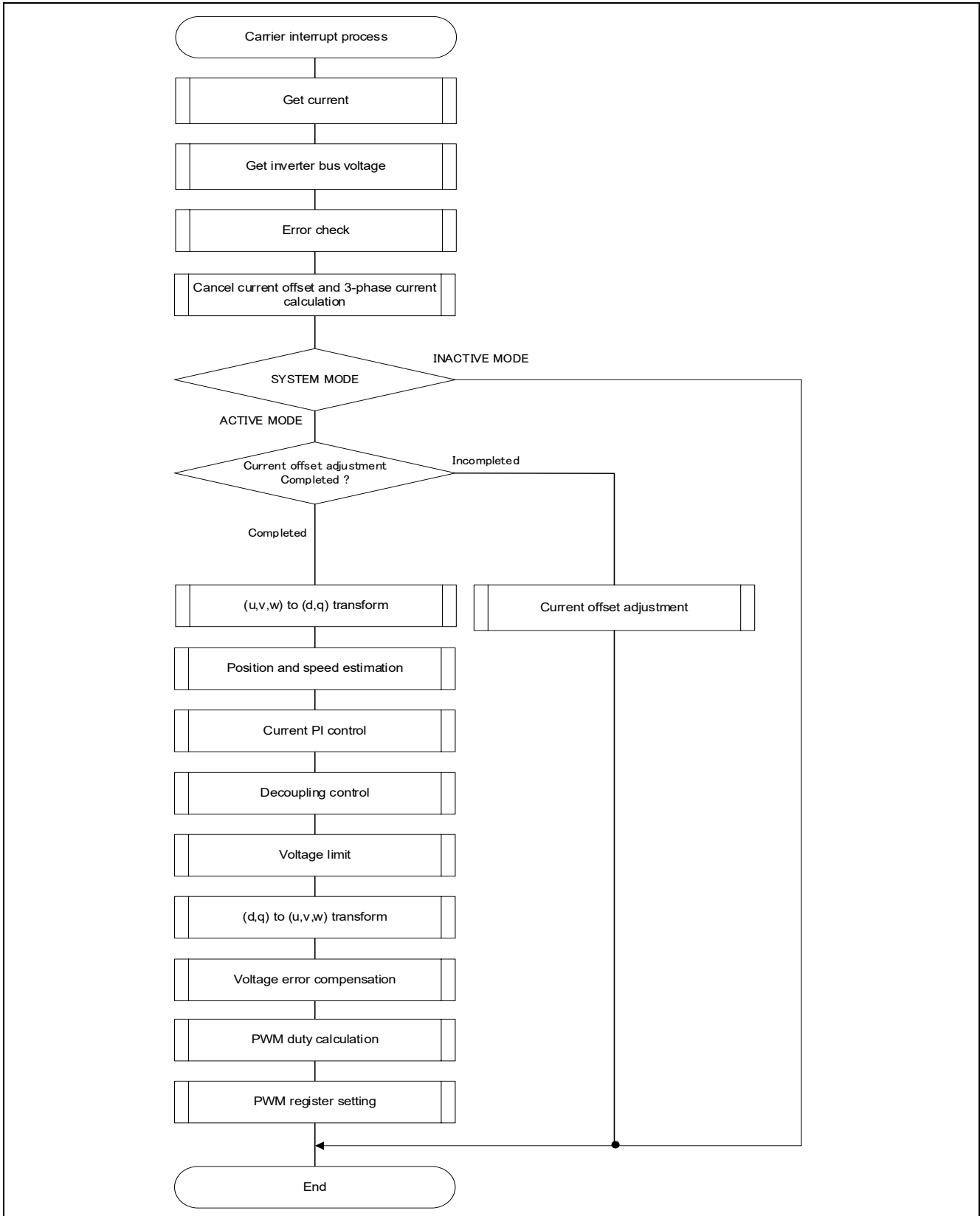

Figure 3-11 Current control Period Interrupt (carrier interrupt) process flowchart

3.5.3 Speed control Period interrupt process

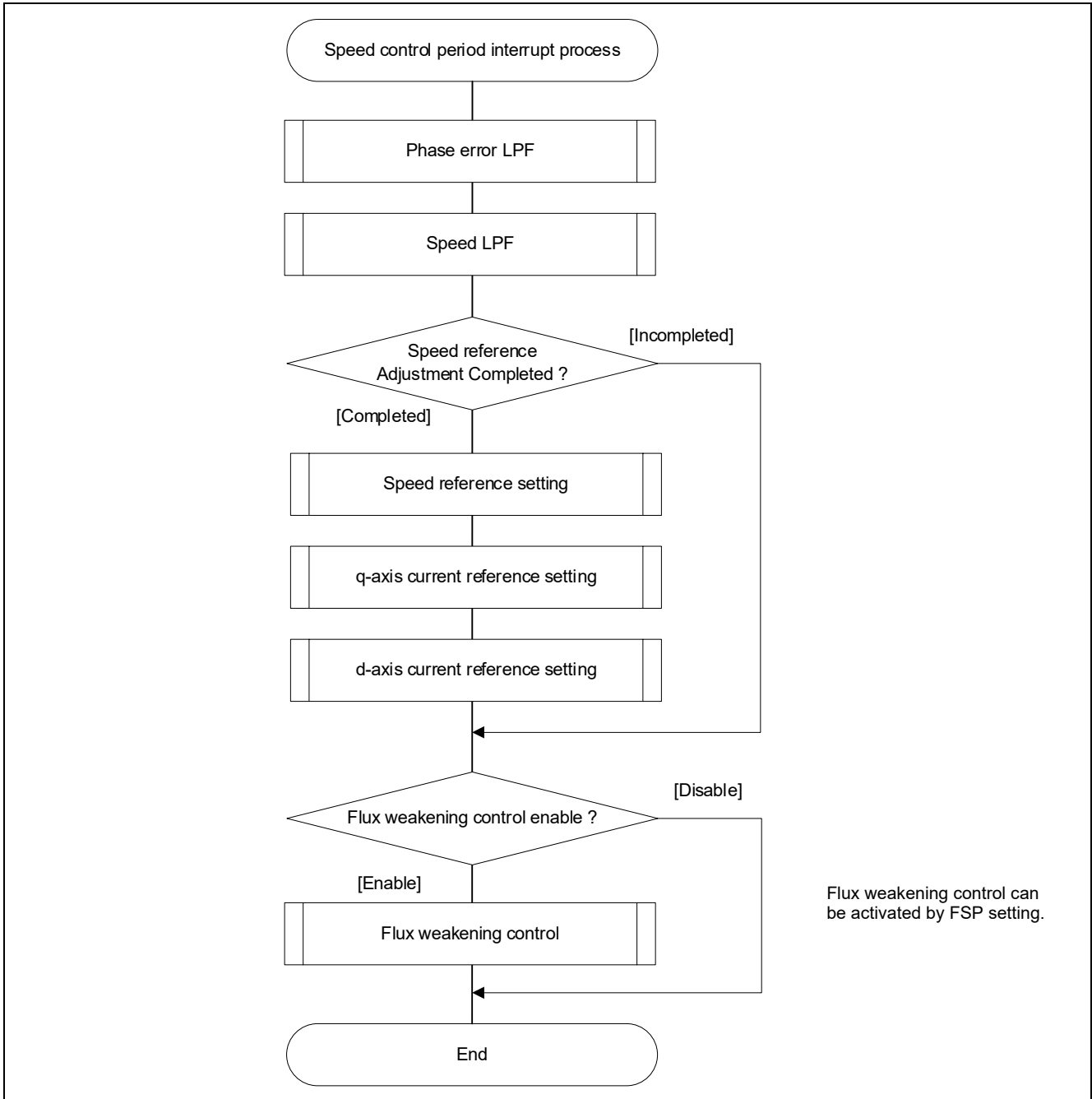

Figure 3-12 Speed Control period interrupt process flowchart

3.5.4 Over current detection interrupt process

The overcurrent detection interrupt is an interrupt that occurs when an external overcurrent detection signal is input. The PWM output terminal are put in the high impedance state. Therefore, at the start of execution of this interrupt processing, the PWM output terminal is already in the high impedance state and the output to the motor had been stopped.

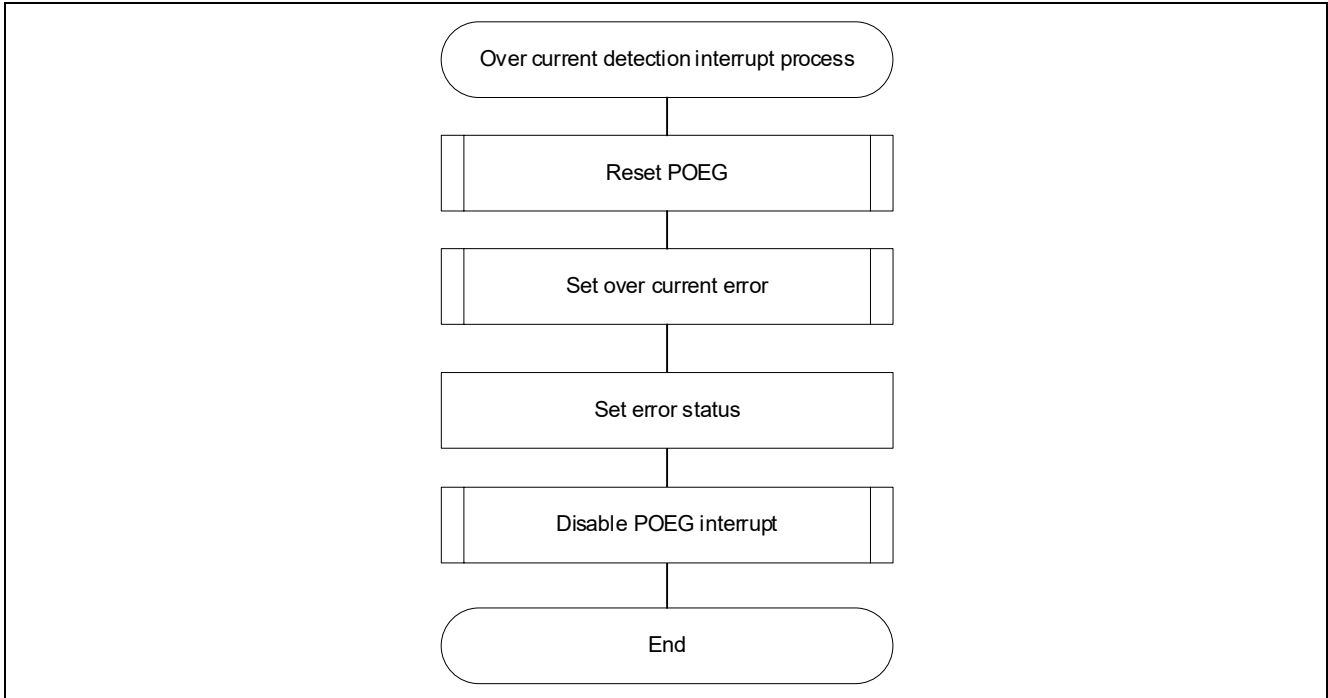

Figure 3-13 Over current detection interrupt process flowchart

4. Project Operation Overview

This section explains the operation of the sample program.

4.1 Quick Start

When executing the sample code only in the evaluation environment without using Renesas motor workbench, the following procedure can be executed

- (1) After turning on stabilized power supply or executing reset, LED1 and LED2 on the inverter board are both off and the motor stops.
- (2) IF the toggle switch (SW1) on the inverter board is turned on, the motor starts to rotate. Every time the toggle switch (SW1) is changed, motor rotation starts/stops alternately. If the motor rotates normally, LED1 on the inverter board is on. However, if LED2 on the inverter board is also on, error is occurring.
- (3) In order to change the direction of the motor rotation, adjust it with the variable resistor (VR1) on the inverter board.
 - Turn the variable resistor (VR1) right: motor rotate clockwise
 - Turn the variable resistor (VR1) left: motor rotate counterclockwise
- (4) If error occurs, LED2 on the inverter board lightens, and the motor rotation stops. To restore, the toggle switch (SW1) on the inverter board needs to be turned off, the push switch (SW) to be pushed and released,
- (5) In order to stop the operation check, turn off the output of the stabilized power supply after making sure that the motor rotation has already stopped.

4.2 Motor Control Development Support Tool ‘Renesas Motor Workbench’

4.2.1 Overview

In the target software of this application note, the motor control development support tool “Renesas Motor Workbench” is used as a user interface (rotating/stop motor, set rotation speed reference, etc). Please refer to ‘Renesas Motor Workbench User’s Manual for usage and more details.

You can find ‘Renesas Motor Workbench’ on Renesas Electronics Corporation website.

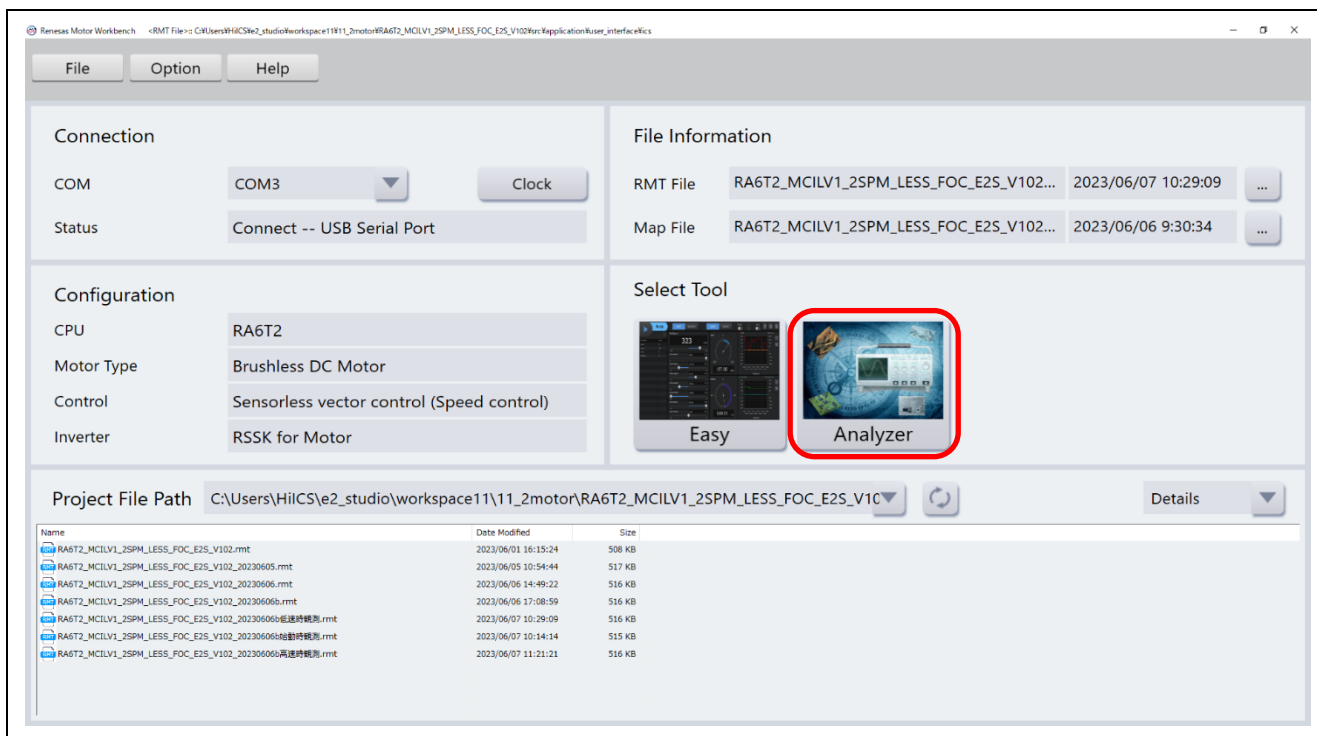

Figure 4-1 Renesas Motor Workbench – Appearance

- Set up for ‘Renesas Motor Workbench’



- (1) Start ‘Renesas Motor Workbench’ by clicking this icon.
- (2) Drop down menu [File] → [Open RMT File(O)].
And select RMT file in ‘[Project Folder]/src/application/user_interface/ics/’.
- (3) Use the ‘Connection’ [COM] select menu to choose the COM port.
- (4) Click the Analyzer button of Select Tool to activate Analyzer function.
- (5) Please refer to ‘4.2.4 Operation example for Analyzer’ for motor driving operation.

4.2.2 Easy function operation example

The following is an example of operating the motor using the Easy function.

- Change the user interface to use Renesas Motor Workbench

(1) Turn on "RMW UI".

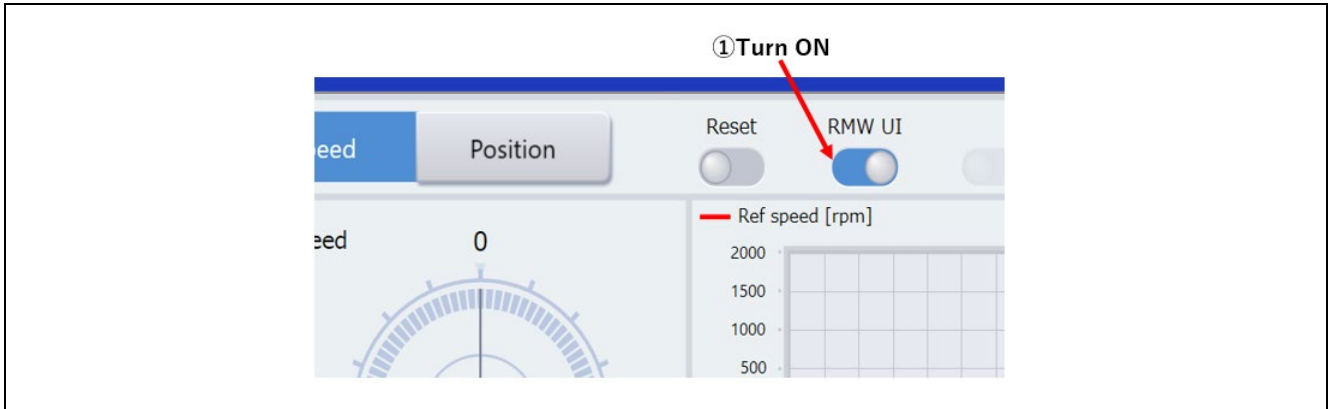

Figure 4-2 Procedure for changing to use Renesas Motor Workbench

- Start rotation of the motor.

(1) Click 'Run' button.

(2) Set 'Ref speed' as speed reference by slider. You also can input target value in numeral area directly.

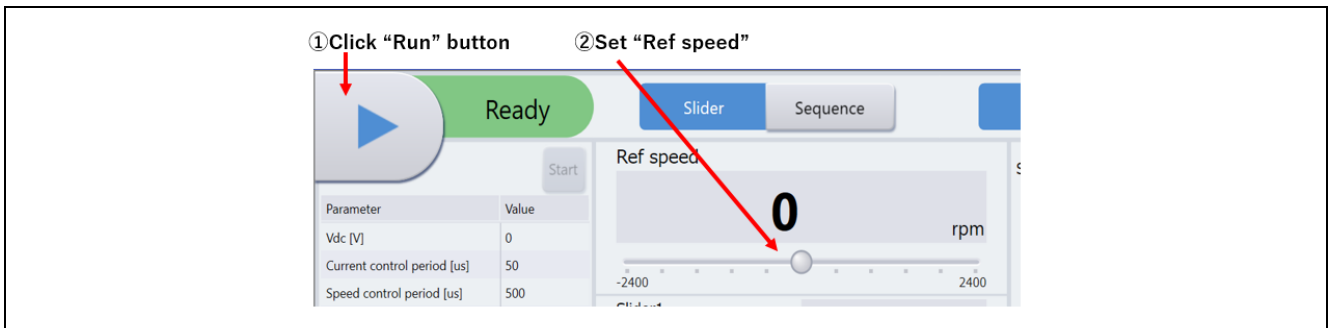

Figure 4-3 Motor rotation procedure

- Stop the motor

(1) Click the "Stop" button

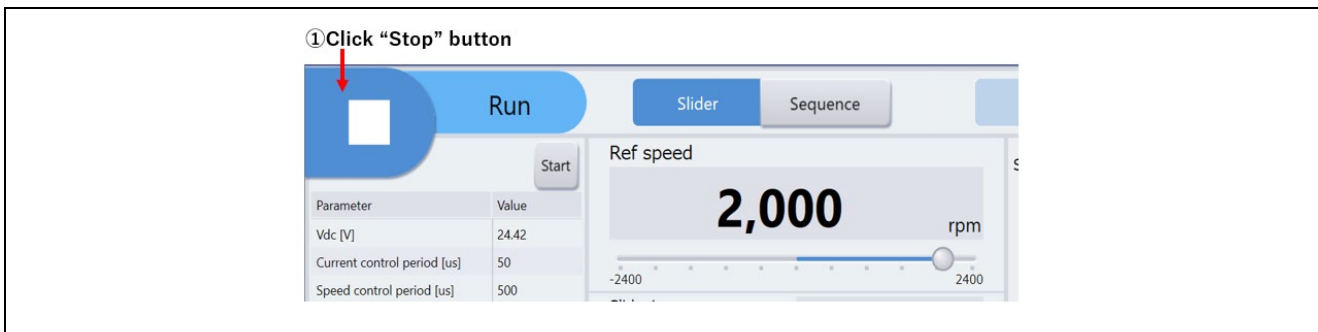

Figure 4-4 Motor rotation procedure

- Processing when it stops (error)

- (1) Turn on "Reset" button.
- (2) Turn off "Reset" button

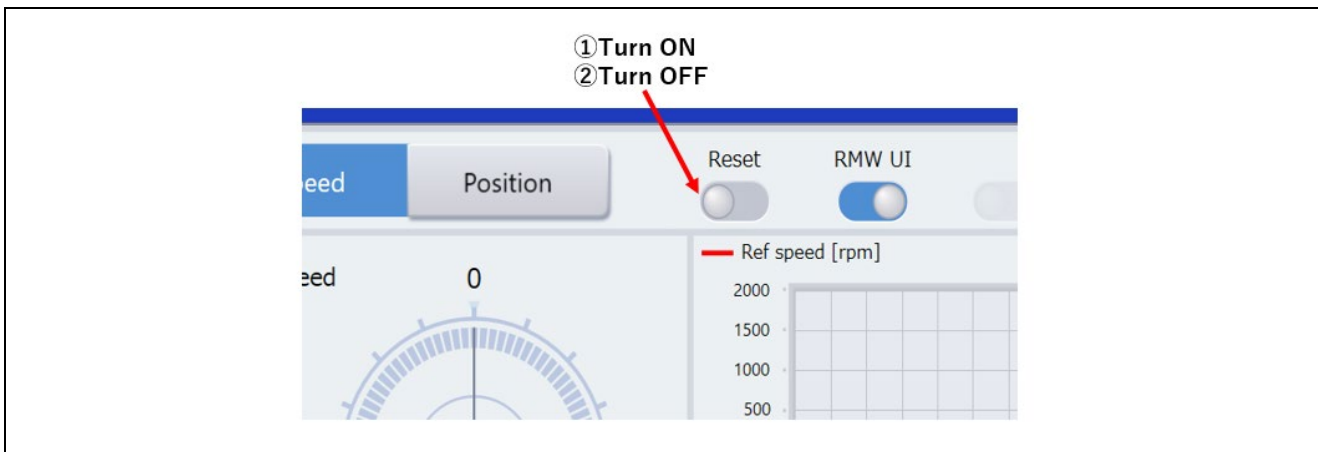

Figure 4-5 Error clearing procedure

4.2.3 List of variables for Analyzer function

Table 4-1 is a list of variables for Analyzer. These variables are reflected to the corresponding variables when the same values as `g_u1_enable_write` are written to `com_u1_enable_write`. However, note that variables with (*) do not depend on `com_u1_enable_write`.

Table 4-1 List of Variables for Analyzer

Variable name	Type	Content
<code>com_u1_sw_userif (*)</code>	<code>uint8_t</code>	User interface switch 0: Analyzer use 1: Board user interface use (default)
<code>com_u1_mode_system(*)</code>	<code>uint8_t</code>	State management 0: Stop mode 1: Run mode 3: Reset
<code>com_f4_ref_speed_rpm</code>	<code>float</code>	Speed reference (mechanical angle) [rpm]
<code>com_u2_mtr_pp</code>	<code>uint16_t</code>	Number of pole pairs
<code>com_f4_mtr_r</code>	<code>float</code>	Resistance [Ω]
<code>com_f4_mtr_ld</code>	<code>float</code>	d-axis Inductance [H]
<code>com_f4_mtr_lq</code>	<code>float</code>	q-axis Inductance [H]
<code>com_f4_mtr_m</code>	<code>float</code>	Magnetic Flux [Wb]
<code>com_f4_mtr_j</code>	<code>float</code>	Inertia [kgm^2]
<code>com_f4_current_omega</code>	<code>float</code>	Natural frequency of current control system [Hz]
<code>com_f4_current_zeta</code>	<code>float</code>	Damping ratio of current control system
<code>com_f4_speed_omega</code>	<code>float</code>	Natural frequency of speed control system [Hz]
<code>com_f4_speed_zeta</code>	<code>float</code>	Damping ratio of speed control system
<code>com_f4_max_speed_rpm</code>	<code>float</code>	Maximum speed value (mechanical angle) [rpm]
<code>com_f4_overspeed_limit_rpm</code>	<code>float</code>	Speed limit (mechanical angle) [rpm]
<code>com_f4_overcurrent_limit</code>	<code>float</code>	Over current limit [A]
<code>com_f4_iq_limit</code>	<code>float</code>	q-axis current limit [A]
<code>com_f4_limit_speed_change</code>	<code>float</code>	Change speed limit (electrical angle) [rad/s]
<code>com_u1_enable_write</code>	<code>uint8_t</code>	Enabled to rewriting variables (rewritten when the same values as <code>g_u1_enable_write</code> are written)

4.2.4 Operation example for Analyzer

This section shows an example of motor driving operation using the Analyzer. Please refer to Figure 4-6 for operation “Control Window”. Regarding the specification of “Control Window”, refer to ‘Renesas Motor Workbench User’s Manual’.

- Change the user interface to Analyzer
 - (1) Confirm the checkboxes of column [W?] for ‘com_u1_sw_userif’ marks.
 - (2) Input ‘0’ in the [Write] box of ‘com_u1_sw_userif’.
 - (3) Click the ‘Write’ button.

- Driving the motor
 - (1) The [W?] check boxes contain checkmarks for “com_u1_mode_system”, “com_f4_ref_speed_rpm”, “com_u1_enable_write”
 - (2) Type a reference speed value in the [Write] box of “com_f4_ref_speed_rpm”.
 - (3) Click the “Write” button.
 - (4) Click the “Read” button. Confirm the [Read] box of “com_f4_ref_speed_rpm” , ”g_u1_enable_write”.
 - (5) Type a same value of “g_u1_enable_write” in the [Write] box of “com_u1_enable_write”.
 - (6) Type a value of “1” in the [Write] box of “com_u1_mode_system”.
 - (7) Click the “Write” button.

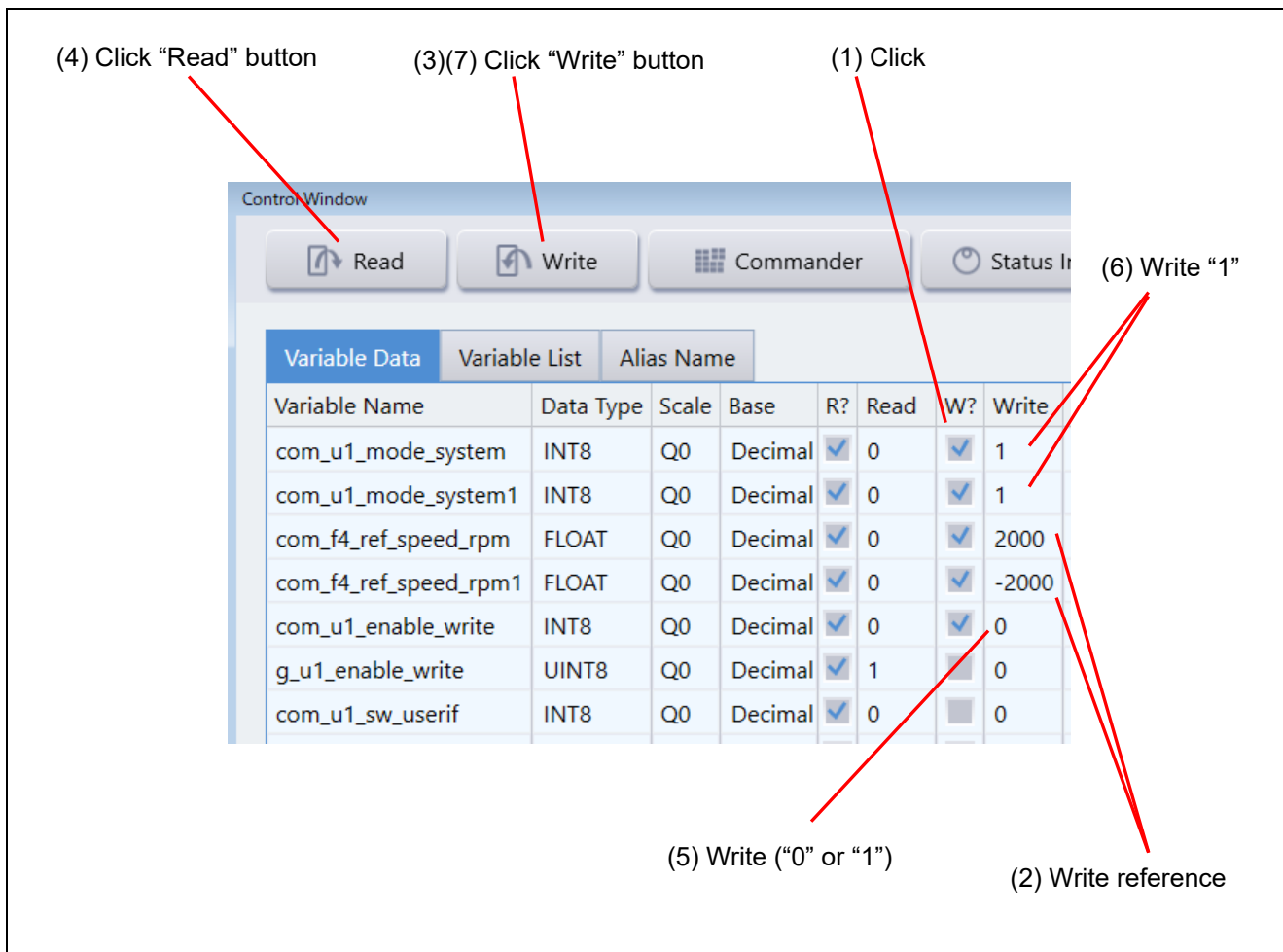

Figure 4-6 Procedure - Driving the motor

- Stop the motor
 - (1) Type a value of "0" in the [Write] box of "com_u1_mode_system".
 - (2) Click the "Write" button.

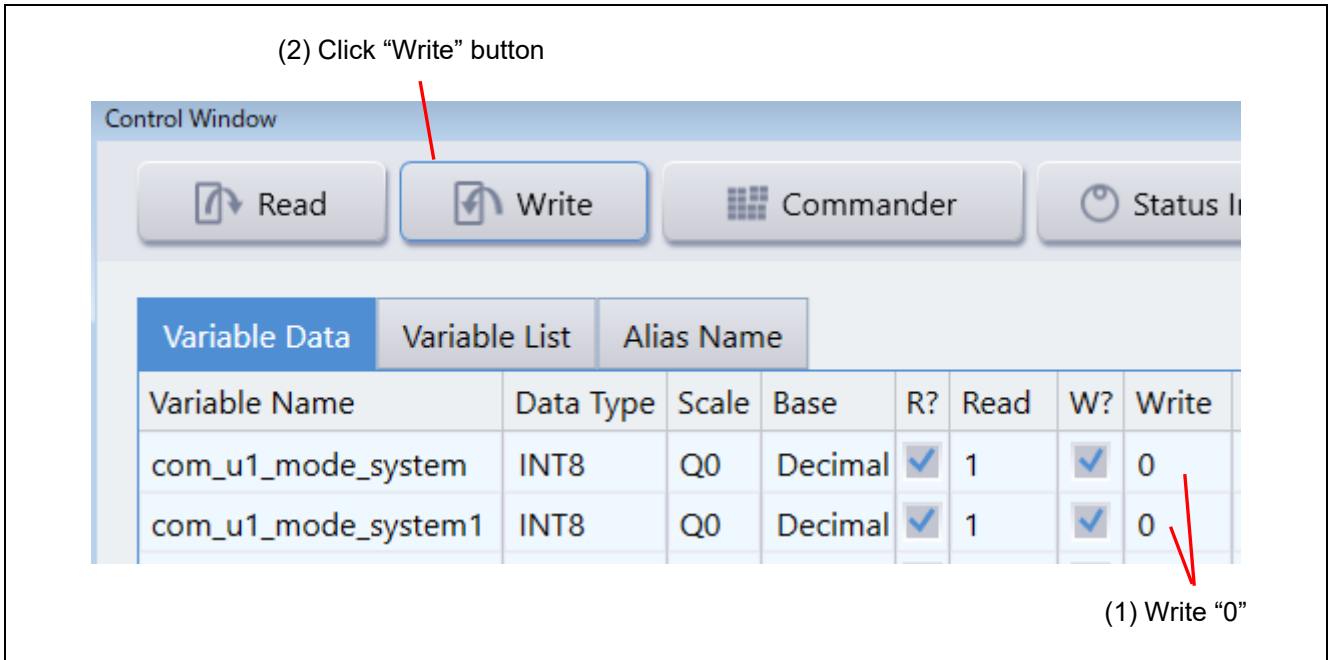

Figure 4-7 Procedure - Stop the motor

- Error cancel operation
 - (1) Type a value of “3” in the [Write] box of “com_u1_mode_system”.
 - (2) Click the “Write” button.

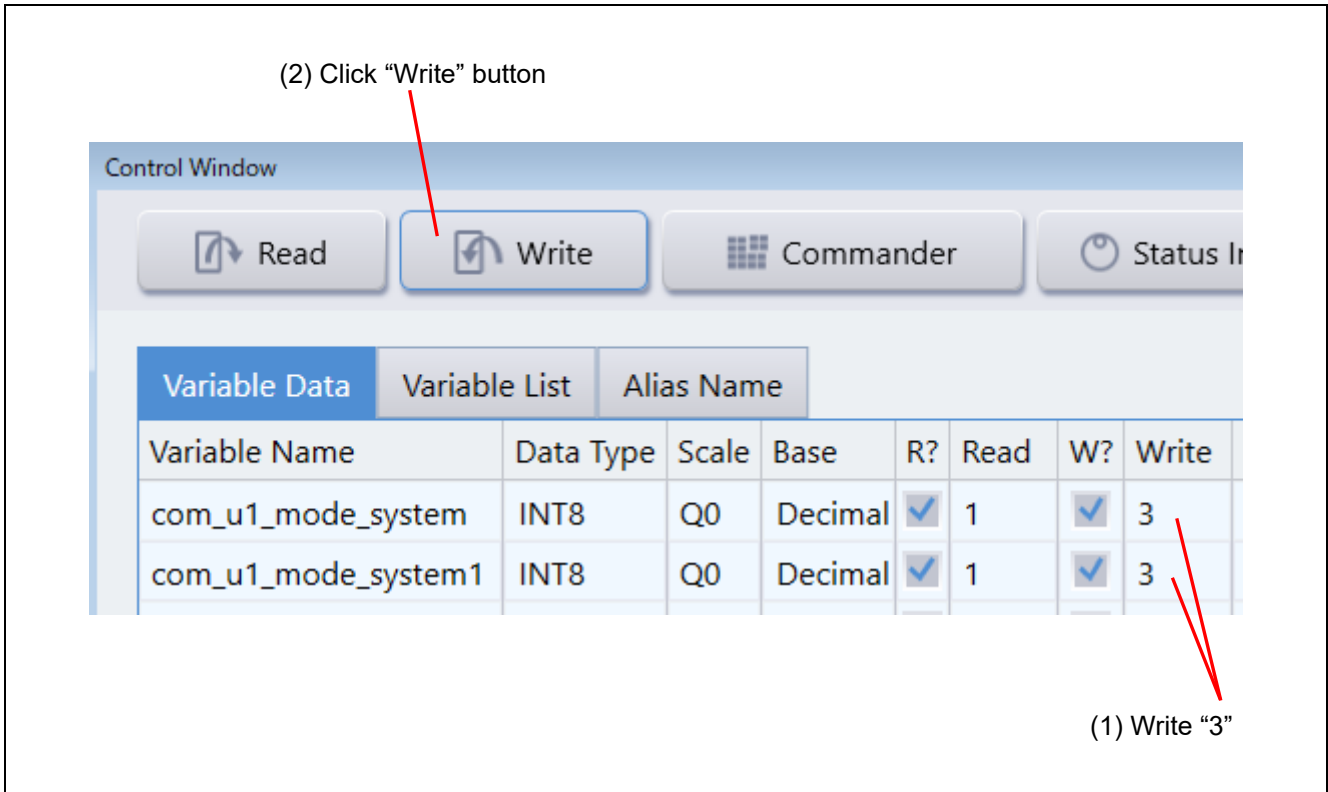

Figure 4-8 Procedure - Error cancel operation

4.2.5 Tuner function

To use the Tuner function, use the executable file provided by Renesas Motor Workbench or "RA6T2(RA8T1,RA6T3,RA4T1)_MCILV1_SPM_HALL_FOC_TUNER_E2S_Vxxx" included in the sample software.

For details on how to use the Tuner function, refer to the Renesas Motor Workbench User’s Manual.

4.2.6 Example of changing communication speed

The procedure for changing the communication speed of Renesas Motor Workbench with the sample software is shown below. See the Renesas Motor Workbench User's Manual for the values to change.

- Change the communication speed setting of the sample software (when the required communication rate is 10 Mbps)
 - (1) Change the value of ICS_BRR in r_mtr_ics.h to 1.
 - (2) Change the value of MTR_ICS_DECIMATION in r_mtr_ics.h to 1.

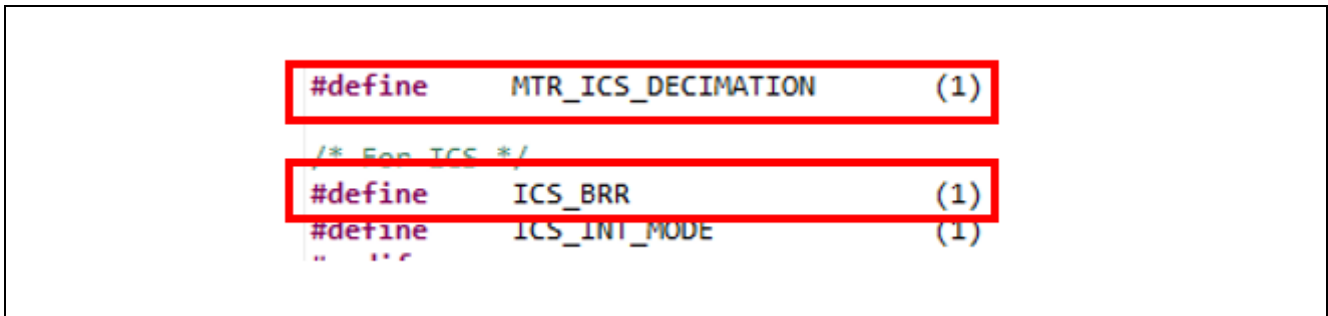

Figure 4-9 Modification of r_mtr_ics.h

- Change the communication speed setting of Renesas Motor Workbench to connect
 - (1) Press the Clock button on the Main Window to change the value to 80,000,000
This value was calculated by multiplying the default 8,000,000 by 10
because the UART communication baud rate was changed from 1Mbps to 10Mbps.
 - (2) Select the COM of the connected kit in the COM of Connection

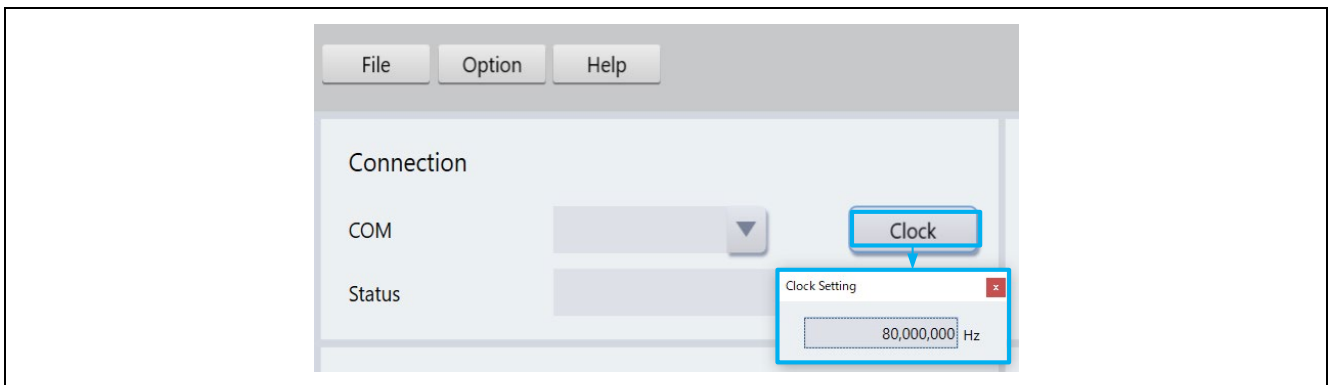

Figure 4-10 Clock frequency setting

If the connection fails, repeat the procedure for reconnecting after resetting the communication board.

4.2.7 How to use the built-in communication library

The procedure for connecting to Renesas Motor Workbench using the built-in communication library without using the communication board with the sample software is shown below.

- Connection between PC and CPU board
 - (1) Connect the CPU board and PC via a USB / serial conversion board, etc.
- Preparing a project for built-in communication (example of RA6T2 921600bps)
 - (1) Cancel the registration of ICS2_RA6T2.o

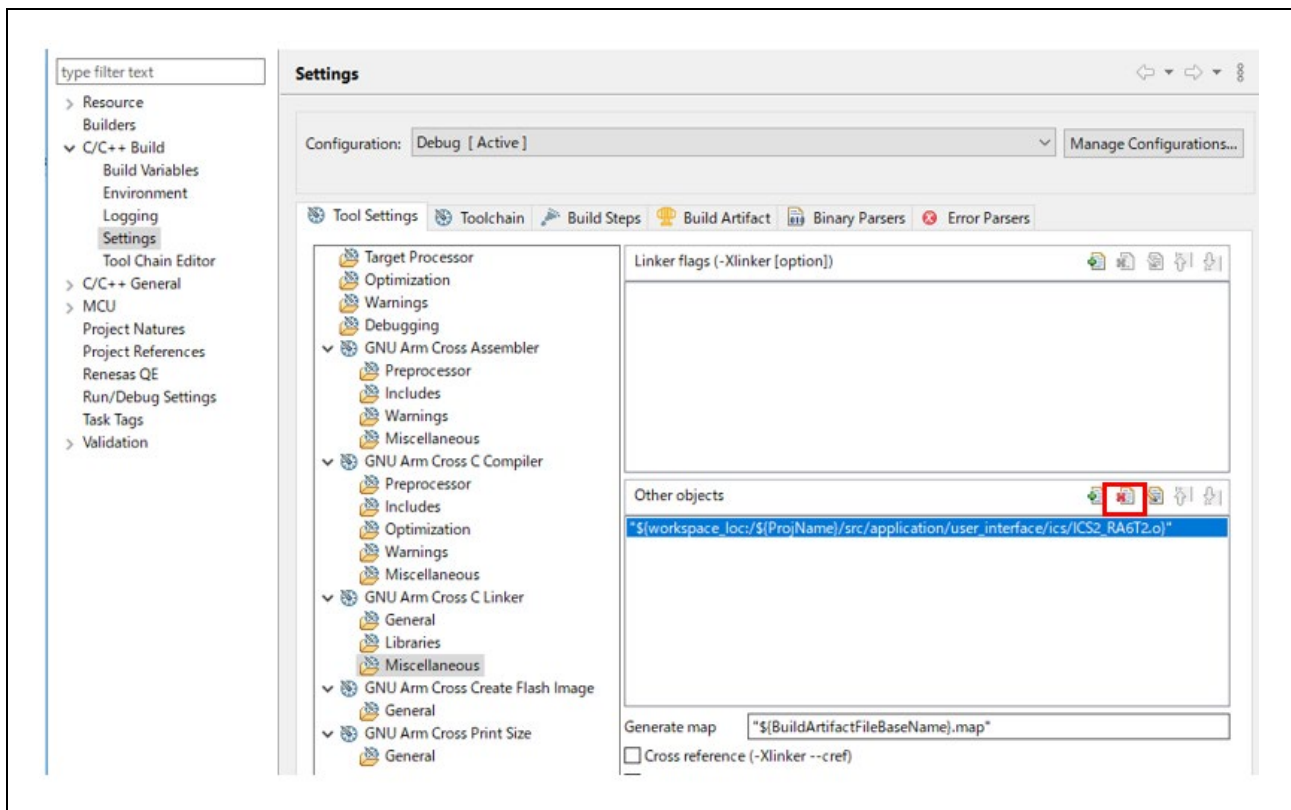

Figure 4-11 Unregister ICS2_RA6T2.o

(2) Register ICS2_RA6T2_Built_in.o

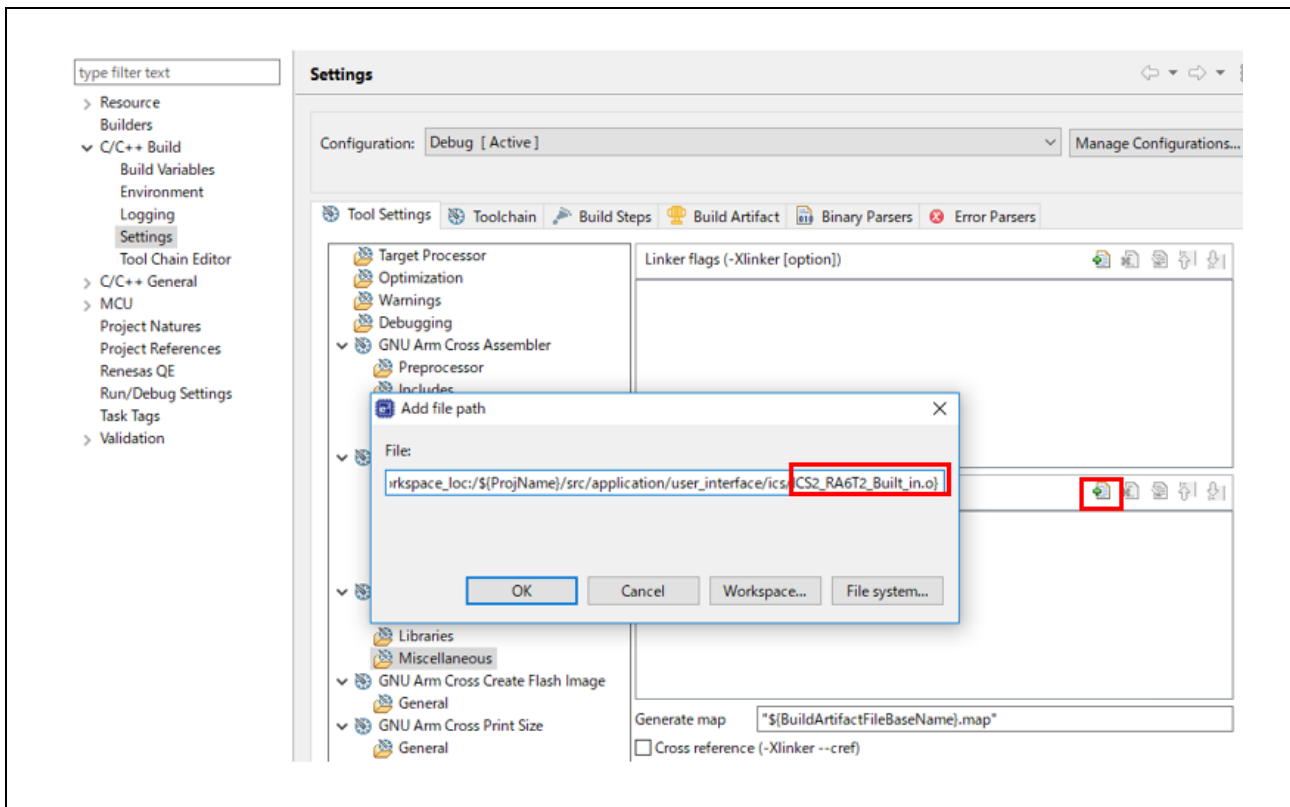

Figure 4-12 Register ICS2_RA6T2.o

(3) Change the value of USE_BUILT_IN in r_mtr_ics.h to 1.

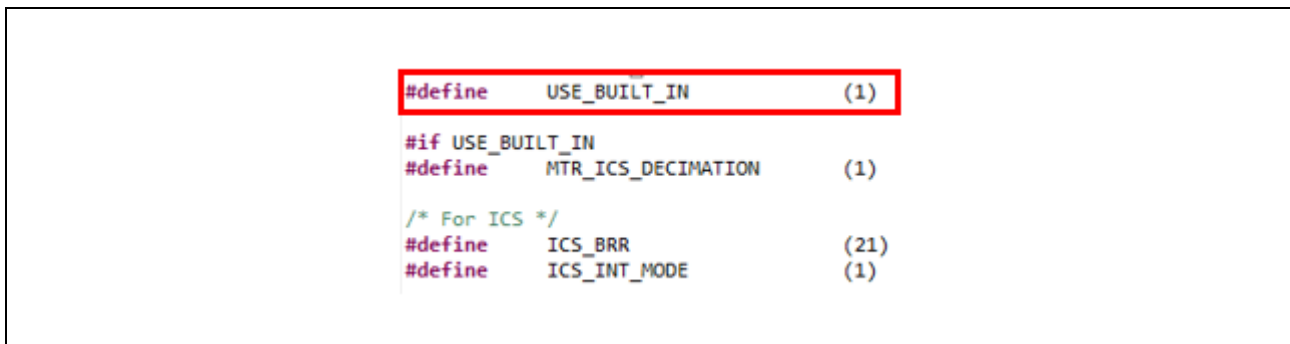

Figure 4-13 Modification of r_mtr_ics.h

- Change the communication baud rate setting of Renesas Motor Workbench to connect
 - (1) Change the value to 921,600 with Baud rate Dialog from the Option menu of the Main Window.
 - (2) Select the COM port of the connected kit in the COM of Connection.

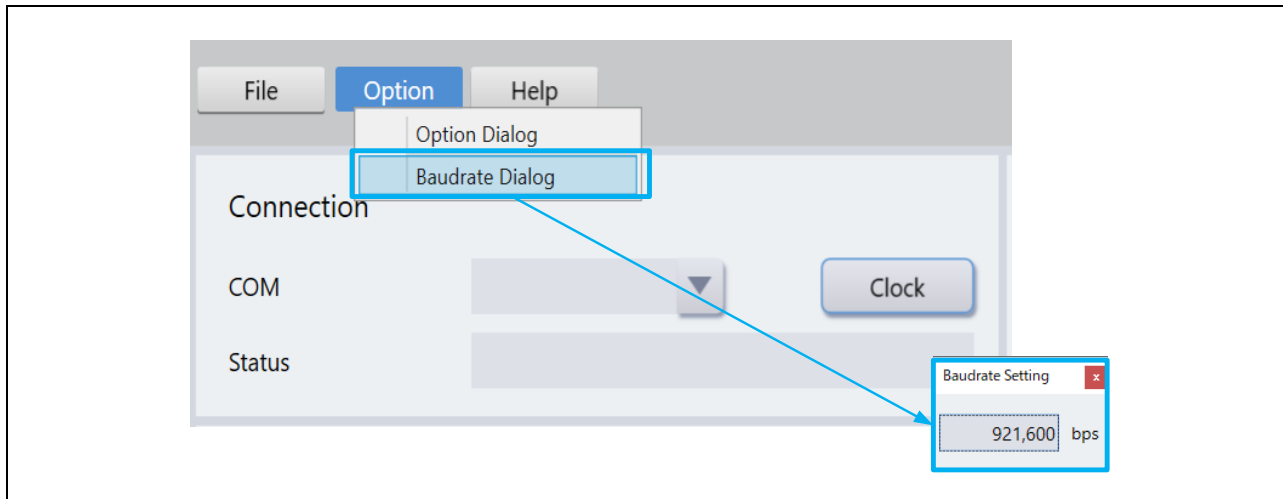

Figure 4-14 Baud rate setting

5. Reference Documents

- RA6T2 Group User's Manual: Hardware (R01UH0951)
- RA8T1 Group User's Manual: Hardware (R01UH1016)
- Renesas Flexible Software Package User's manual
(PDF version : R11UM0155, Web version : RA Flexible Software Package Documentation)
- Renesas e2 studio 2022-07 or higher User's Manual: Quick Start Guide (R20UT5210)
- Application note: Sensorless vector control for permanent magnet synchronous motor (Algorithm)
(R01AN3786)
- Renesas Motor Workbench User's Manual (R21UZ0004)
- Renesas Motor Workbench Quick start guide (R21QS0011)
- MCK-RA6T2 User's Manual (R12UZ0091)
- MCK-RA8T1 User's Manual (R12UZ0133)

Revision History

Rev.	Date	Description	
		Page	Summary
1.00	Jun 29, 2022	-	First edition issued
1.10	Aug 30, 2023	-	<ul style="list-style-type: none">• Updated for Renesas Flexible Motor Control Series• Updated "3.1.6 Start-up method"
1.20	Jan 23, 2024	-	<ul style="list-style-type: none">• Added description related to RA8T1, RA6T3 and RA4T1

General Precautions in the Handling of Microprocessing Unit and Microcontroller Unit Products

The following usage notes are applicable to all Microprocessing unit and Microcontroller unit products from Renesas. For detailed usage notes on the products covered by this document, refer to the relevant sections of the document as well as any technical updates that have been issued for the products.

1. Precaution against Electrostatic Discharge (ESD)

A strong electrical field, when exposed to a CMOS device, can cause destruction of the gate oxide and ultimately degrade the device operation. Steps must be taken to stop the generation of static electricity as much as possible, and quickly dissipate it when it occurs. Environmental control must be adequate. When it is dry, a humidifier should be used. This is recommended to avoid using insulators that can easily build up static electricity.

Semiconductor devices must be stored and transported in an anti-static container, static shielding bag or conductive material. All test and measurement tools including work benches and floors must be grounded. The operator must also be grounded using a wrist strap. Semiconductor devices must not be touched with bare hands. Similar precautions must be taken for printed circuit boards with mounted semiconductor devices.

2. Processing at power-on

The state of the product is undefined at the time when power is supplied. The states of internal circuits in the LSI are indeterminate and the states of register settings and pins are undefined at the time when power is supplied. In a finished product where the reset signal is applied to the external reset pin, the states of pins are not guaranteed from the time when power is supplied until the reset process is completed. In a similar way, the states of pins in a product that is reset by an on-chip power-on reset function are not guaranteed from the time when power is supplied until the power reaches the level at which resetting is specified.

3. Input of signal during power-off state

Do not input signals or an I/O pull-up power supply while the device is powered off. The current injection that results from input of such a signal or I/O pull-up power supply may cause malfunction and the abnormal current that passes in the device at this time may cause degradation of internal elements. Follow the guideline for input signal during power-off state as described in your product documentation.

4. Handling of unused pins

Handle unused pins in accordance with the directions given under handling of unused pins in the manual. The input pins of CMOS products are generally in the high-impedance state. In operation with an unused pin in the open-circuit state, extra electromagnetic noise is induced in the vicinity of the LSI, an associated shoot-through current flows internally, and malfunctions occur due to the false recognition of the pin state as an input signal become possible.

5. Clock signals

After applying a reset, only release the reset line after the operating clock signal becomes stable. When switching the clock signal during program execution, wait until the target clock signal is stabilized. When the clock signal is generated with an external resonator or from an external oscillator during a reset, ensure that the reset line is only released after full stabilization of the clock signal. Additionally, when switching to a clock signal produced with an external resonator or by an external oscillator while program execution is in progress, wait until the target clock signal is stable.

6. Voltage application waveform at input pin

Waveform distortion due to input noise or a reflected wave may cause malfunction. If the input of the CMOS device stays in the area between V_{IL} (Max.) and V_{IH} (Min.) due to noise, for example, the device may malfunction. Take care to prevent chattering noise from entering the device when the input level is fixed, and also in the transition period when the input level passes through the area between V_{IL} (Max.) and V_{IH} (Min.).

7. Prohibition of access to reserved addresses

Access to reserved addresses is prohibited. The reserved addresses are provided for possible future expansion of functions. Do not access these addresses as the correct operation of the LSI is not guaranteed.

8. Differences between products

Before changing from one product to another, for example to a product with a different part number, confirm that the change will not lead to problems. The characteristics of a microprocessing unit or microcontroller unit products in the same group but having a different part number might differ in terms of internal memory capacity, layout pattern, and other factors, which can affect the ranges of electrical characteristics, such as characteristic values, operating margins, immunity to noise, and amount of radiated noise. When changing to a product with a different part number, implement a system-evaluation test for the given product.

Notice

1. Descriptions of circuits, software and other related information in this document are provided only to illustrate the operation of semiconductor products and application examples. You are fully responsible for the incorporation or any other use of the circuits, software, and information in the design of your product or system. Renesas Electronics disclaims any and all liability for any losses and damages incurred by you or third parties arising from the use of these circuits, software, or information.
2. Renesas Electronics hereby expressly disclaims any warranties against and liability for infringement or any other claims involving patents, copyrights, or other intellectual property rights of third parties, by or arising from the use of Renesas Electronics products or technical information described in this document, including but not limited to, the product data, drawings, charts, programs, algorithms, and application examples.
3. No license, express, implied or otherwise, is granted hereby under any patents, copyrights or other intellectual property rights of Renesas Electronics or others.
4. You shall be responsible for determining what licenses are required from any third parties, and obtaining such licenses for the lawful import, export, manufacture, sales, utilization, distribution or other disposal of any products incorporating Renesas Electronics products, if required.
5. You shall not alter, modify, copy, or reverse engineer any Renesas Electronics product, whether in whole or in part. Renesas Electronics disclaims any and all liability for any losses or damages incurred by you or third parties arising from such alteration, modification, copying or reverse engineering.
6. Renesas Electronics products are classified according to the following two quality grades: "Standard" and "High Quality". The intended applications for each Renesas Electronics product depends on the product's quality grade, as indicated below.
 - "Standard": Computers; office equipment; communications equipment; test and measurement equipment; audio and visual equipment; home electronic appliances; machine tools; personal electronic equipment; industrial robots; etc.
 - "High Quality": Transportation equipment (automobiles, trains, ships, etc.); traffic control (traffic lights); large-scale communication equipment; key financial terminal systems; safety control equipment; etc.Unless expressly designated as a high reliability product or a product for harsh environments in a Renesas Electronics data sheet or other Renesas Electronics document, Renesas Electronics products are not intended or authorized for use in products or systems that may pose a direct threat to human life or bodily injury (artificial life support devices or systems; surgical implantations; etc.), or may cause serious property damage (space system; undersea repeaters; nuclear power control systems; aircraft control systems; key plant systems; military equipment; etc.). Renesas Electronics disclaims any and all liability for any damages or losses incurred by you or any third parties arising from the use of any Renesas Electronics product that is inconsistent with any Renesas Electronics data sheet, user's manual or other Renesas Electronics document.
7. No semiconductor product is absolutely secure. Notwithstanding any security measures or features that may be implemented in Renesas Electronics hardware or software products, Renesas Electronics shall have absolutely no liability arising out of any vulnerability or security breach, including but not limited to any unauthorized access to or use of a Renesas Electronics product or a system that uses a Renesas Electronics product. RENESAS ELECTRONICS DOES NOT WARRANT OR GUARANTEE THAT RENESAS ELECTRONICS PRODUCTS, OR ANY SYSTEMS CREATED USING RENESAS ELECTRONICS PRODUCTS WILL BE INVULNERABLE OR FREE FROM CORRUPTION, ATTACK, VIRUSES, INTERFERENCE, HACKING, DATA LOSS OR THEFT, OR OTHER SECURITY INTRUSION ("Vulnerability Issues"). RENESAS ELECTRONICS DISCLAIMS ANY AND ALL RESPONSIBILITY OR LIABILITY ARISING FROM OR RELATED TO ANY VULNERABILITY ISSUES. FURTHERMORE, TO THE EXTENT PERMITTED BY APPLICABLE LAW, RENESAS ELECTRONICS DISCLAIMS ANY AND ALL WARRANTIES, EXPRESS OR IMPLIED, WITH RESPECT TO THIS DOCUMENT AND ANY RELATED OR ACCOMPANYING SOFTWARE OR HARDWARE, INCLUDING BUT NOT LIMITED TO THE IMPLIED WARRANTIES OF MERCHANTABILITY, OR FITNESS FOR A PARTICULAR PURPOSE.
8. When using Renesas Electronics products, refer to the latest product information (data sheets, user's manuals, application notes, "General Notes for Handling and Using Semiconductor Devices" in the reliability handbook, etc.), and ensure that usage conditions are within the ranges specified by Renesas Electronics with respect to maximum ratings, operating power supply voltage range, heat dissipation characteristics, installation, etc. Renesas Electronics disclaims any and all liability for any malfunctions, failure or accident arising out of the use of Renesas Electronics products outside of such specified ranges.
9. Although Renesas Electronics endeavors to improve the quality and reliability of Renesas Electronics products, semiconductor products have specific characteristics, such as the occurrence of failure at a certain rate and malfunctions under certain use conditions. Unless designated as a high reliability product or a product for harsh environments in a Renesas Electronics data sheet or other Renesas Electronics document, Renesas Electronics products are not subject to radiation resistance design. You are responsible for implementing safety measures to guard against the possibility of bodily injury, injury or damage caused by fire, and/or danger to the public in the event of a failure or malfunction of Renesas Electronics products, such as safety design for hardware and software, including but not limited to redundancy, fire control and malfunction prevention, appropriate treatment for aging degradation or any other appropriate measures. Because the evaluation of microcomputer software alone is very difficult and impractical, you are responsible for evaluating the safety of the final products or systems manufactured by you.
10. Please contact a Renesas Electronics sales office for details as to environmental matters such as the environmental compatibility of each Renesas Electronics product. You are responsible for carefully and sufficiently investigating applicable laws and regulations that regulate the inclusion or use of controlled substances, including without limitation, the EU RoHS Directive, and using Renesas Electronics products in compliance with all these applicable laws and regulations. Renesas Electronics disclaims any and all liability for damages or losses occurring as a result of your noncompliance with applicable laws and regulations.
11. Renesas Electronics products and technologies shall not be used for or incorporated into any products or systems whose manufacture, use, or sale is prohibited under any applicable domestic or foreign laws or regulations. You shall comply with any applicable export control laws and regulations promulgated and administered by the governments of any countries asserting jurisdiction over the parties or transactions.
12. It is the responsibility of the buyer or distributor of Renesas Electronics products, or any other party who distributes, disposes of, or otherwise sells or transfers the product to a third party, to notify such third party in advance of the contents and conditions set forth in this document.
13. This document shall not be reprinted, reproduced or duplicated in any form, in whole or in part, without prior written consent of Renesas Electronics.
14. Please contact a Renesas Electronics sales office if you have any questions regarding the information contained in this document or Renesas Electronics products.

(Note1) "Renesas Electronics" as used in this document means Renesas Electronics Corporation and also includes its directly or indirectly controlled subsidiaries.

(Note2) "Renesas Electronics product(s)" means any product developed or manufactured by or for Renesas Electronics.

(Rev.5.0-1 October 2020)

Corporate Headquarters

TOYOSU FORESIA, 3-2-24 Toyosu,
Koto-ku, Tokyo 135-0061, Japan

www.renesas.com

Trademarks

Renesas and the Renesas logo are trademarks of Renesas Electronics Corporation. All trademarks and registered trademarks are the property of their respective owners.

Contact information

For further information on a product, technology, the most up-to-date version of a document, or your nearest sales office, please visit:

www.renesas.com/contact/.