

QE for Motor V1.1.0

Release Note

Thank you very much for using the QE for Motor V1.1.0.

This release note covers product installation, restrictions, and so on. Please read this document before using the product.

Contents

1.	About QE for Motor.....	2
1.1	Overview	2
1.2	Features	2
1.3	Changes in V1.1.0.....	4
1.3.1	Support for RA6T1	4
1.3.2	Addition of the Function for Installing the Renesas Motor Workbench	4
1.3.3	Addition of the Function for Importing a Sample Motor Program.....	4
1.3.4	Addition of a Function for Magnifying and Reducing the Motor Configuration GUIs.....	5
1.3.5	Change to the Timing for Evaluating Values Input with the Motor Configuration GUI	5
1.3.6	Change to Files for Output of the Results of Tuning.....	5
1.4	Supported Environment.....	5
1.5	Supported Microcontrollers.....	5
1.6	Supported Software.....	6
2.	Installation and Uninstallation	7
2.1	Installing This Product.....	7
2.1.1	Install from the "Renesas Software Installer" menu of e ² studio.....	7
2.1.2	Install using QE (zip file) downloaded from the Renesas website	7
2.2	Updating This Product.....	8
2.2.1	Download the latest version of QE for Motor from the Renesas Web site and install it	8
2.2.2	Uninstall V1.0.0 of QE for Motor [RA] and use the Renesas Software Installer of the e ² studio to install the latest version of QE for Motor.....	8
2.3	Uninstalling This Product.....	9
3.	Notes / Restrictions	9
3.1	Usage Considerations	9
3.1.1	Notes on the display of the [Motor Main (QE)] view	9
3.1.2	Notes on generating a tuning program	9
3.2	Functional Restrictions	11
	Revision History	12

1. About QE for Motor

1.1 Overview

QE for Motor is an assistance tool for applications that operates in the e² studio integrated development environment. For the development of embedded systems that include motor software and are based on the RA6T1 or RA6T2, this product offers the following features.

- Configuration of motor middleware and related drivers provided in the Flexible Software Package (FSP)
- Assistance in tuning and analysis in coordination with the Renesas Motor Workbench

1.2 Features

QE for Motor has the three features below for supporting the development of motor software.

1. Workflow diagram

Following [Workflow Diagram] in the [Motor Main (QE)] view enables configuration of the middleware and related drivers for motors. Also, tuning and analysis can be implemented through coordination with the Renesas Motor Workbench.

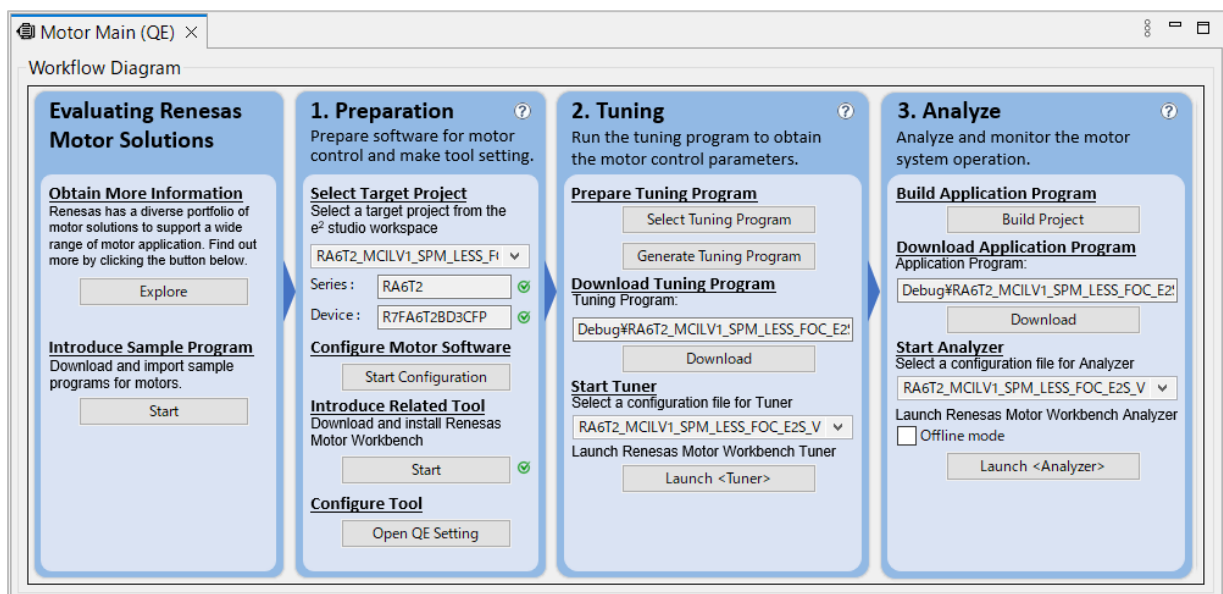

2. Motor configuration GUI

By changing the properties of the FSP in the GUI, you can configure the middleware and related drivers for motors. The hierarchical structures of the block diagram enable efficient operations.

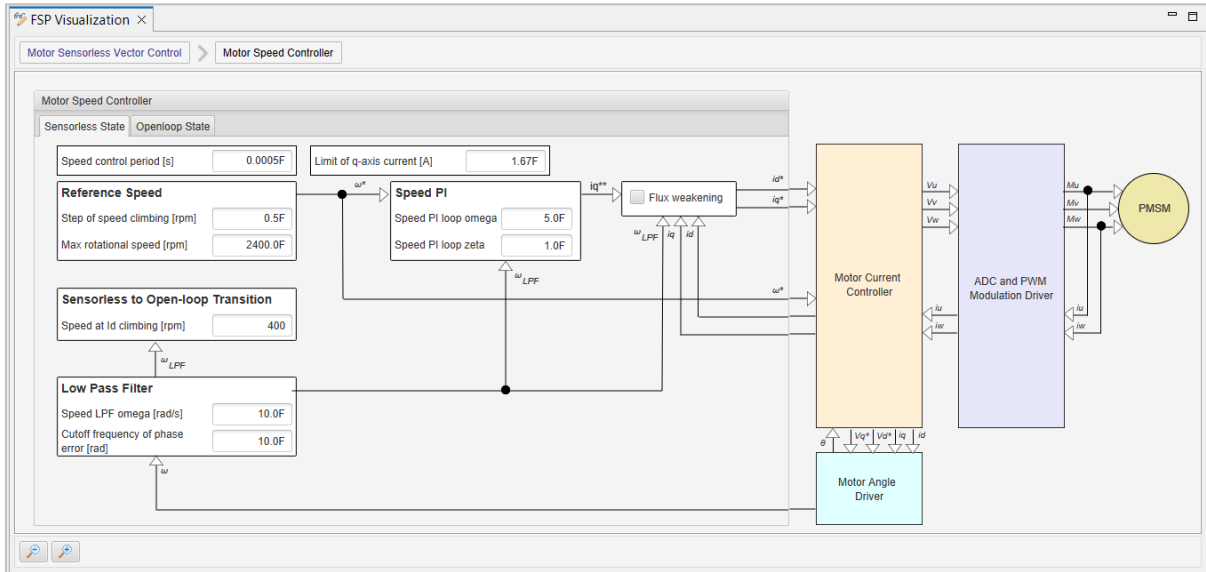

The motor configuration GUI is displayed in the [FSP Visualization] view of the e² studio. The [FSP Visualization] view is opened in the [FSP Configuration] perspective. The [FSP Visualization] view can also be opened from the main menu of the e² studio, by selecting [Renesas Views] -> [C/C++] -> [FSP Visualization].

The motor configuration GUI is displayed when selecting the stack of the FSP module listed in 1.6 **Supported Software** on the [Stacks] tabbed page of the FSP configuration editor.

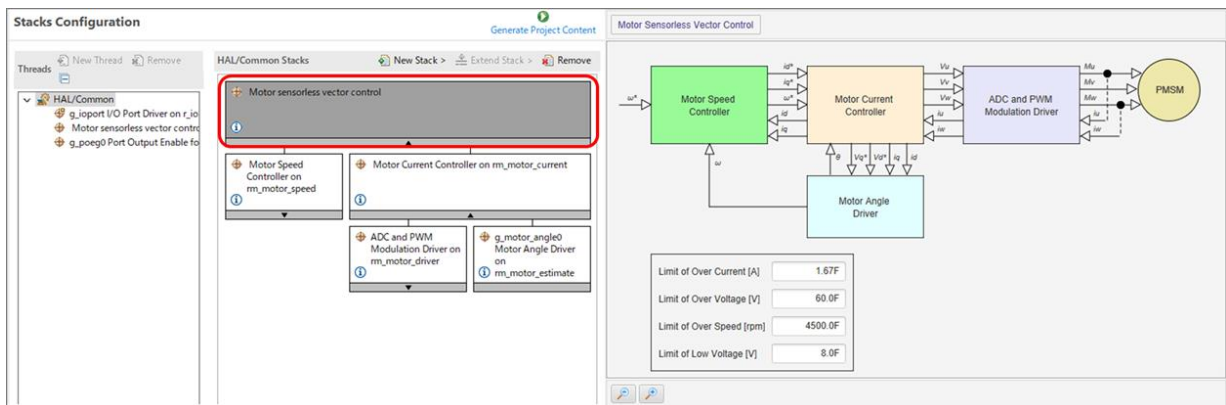

3. Coordination with the Renesas Motor Workbench

QE for Motor can operate in coordination with the Renesas Motor Workbench for the processes of tuning and analysis of the motor. Since QE for Motor automatically makes the necessary settings for starting the Renesas Motor Workbench, you can tune and analyze the motor by clicking on the buttons in the window of QE for Motor.



1.3 Changes in V1.1.0

1.3.1 Support for RA6T1

QE for Motor now supports RA6T1 group MCUs.

1.3.2 Addition of the Function for Installing the Renesas Motor Workbench

In the [Motor Main (QE)] view, you can download and install the Renesas Motor Workbench from the Renesas Electronics Web page by using buttons on the workflow diagram. A My Renesas account is required to download the Renesas Motor Workbench.

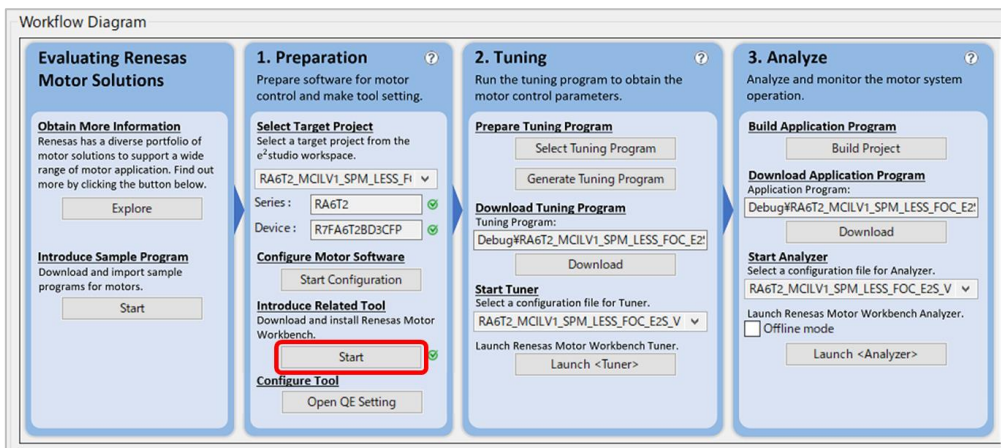

1.3.3 Addition of the Function for Importing a Sample Motor Program

In the [Motor Main (QE)] view, you can download the e² studio project for a sample motor program and install it in the e² studio workspace. Downloading and importing required projects is enabled by using buttons on the workflow diagram to acquire a list of the target projects from the Renesas Electronics Web page. A My Renesas account is required to download the projects.

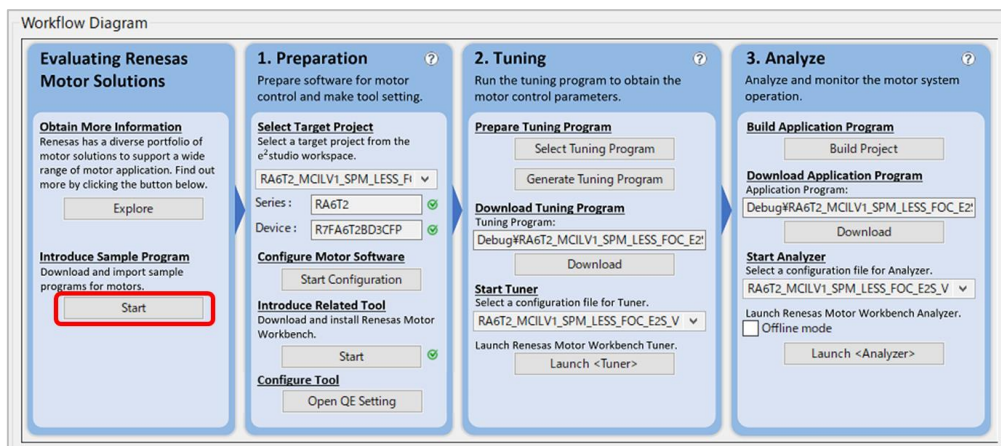

1.3.4 Addition of a Function for Magnifying and Reducing the Motor Configuration GUIs

You can magnify or reduce the motor configuration GUIs displayed in the [FSP Visualization] view. Use the [Zoom in] or [Zoom out] button or the [Ctrl] key with the mouse wheel.

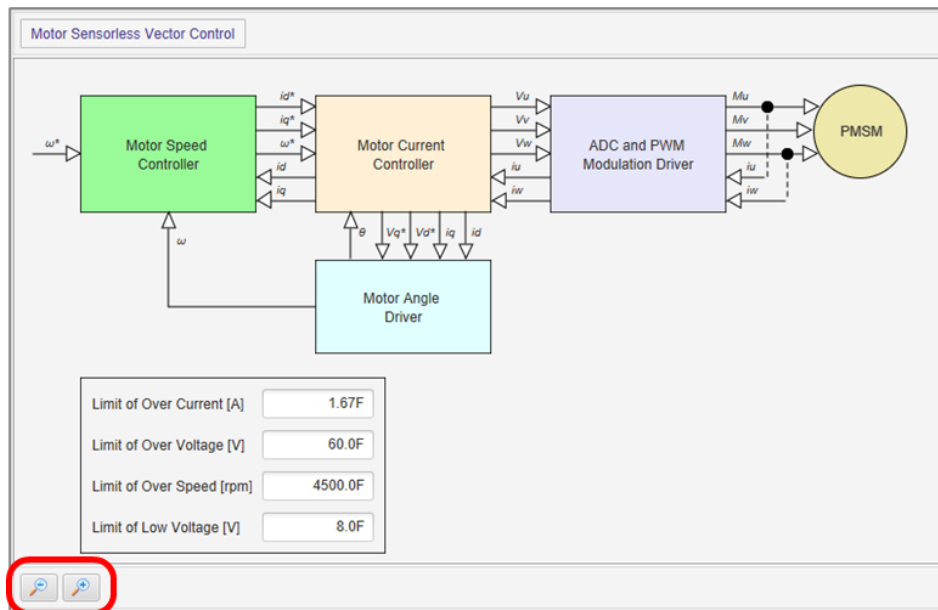

1.3.5 Change to the Timing for Evaluating Values Input with the Motor Configuration GUI

The timing for evaluating values input with the motor configuration GUI in the [FSP Visualization] view has been changed from the time when characters are entered to the time when the [Enter] key is pressed or the input focus is moved. If an invalid value is input, it is evaluated when the [Enter] key is pressed or the input focus is moved and restored to the pre-editing value.

1.3.6 Change to Files for Output of the Results of Tuning

When a tuner of the Renesas Motor Workbench is started in the [Motor Main (QE)] view, the results of tuning are output to the following files.

	Filename before Change (V1.0.0)	Filename after Change (V1.1.0)
Motor parameter	r_mtr_control_parameter.h	r_mtr_motor_parameter.h
Control parameter	r_mtr_motor_parameter.h	r_mtr_control_parameter.h

1.4 Supported Environment

- Windows 8.1, and Windows 10 (64bit)
- Renesas e² studio 2021-10 (or later)
 - * If you are using a version of the e² studio earlier than 2021-10, please update it to 2021-10 or later.
- Renesas Motor Workbench V3.0.0(or later)
 - * If you are using a version of the Renesas Motor Workbench earlier than V3.0.0, please update it to V3.0.0 or later.

1.5 Supported Microcontrollers

- RA Family
 - RA6T Series: RA6T1 and RA6T2

1.6 Supported Software

- Middleware for motor
 - RA Flexible Software Package (FSP)
 - Motor Sensorless Vector Control: rm_motor_sensorless V3.5.0 (or later)
 - Motor Encoder Vector Control: rm_motor_encoder V3.5.0(or later)
 - 120-degree control: rm_motor_120_degree V3.5.0(or later)

2. Installation and Uninstallation

2.1 Installing This Product

Use either of the following procedures to install this product.

2.1.1 Install from the "Renesas Software Installer" menu of e² studio

1. Start e² studio.
2. Select the "Renesas Views" – "Renesas Software Installer" menu of e² studio to open the "Renesas Software Installer" dialog box.
3. Select the "Renesas QE" and click the "Next>" button
4. Select the "QE for Motor(v1.1.0)" check box, and click the "Finish" button.
5. Check that the "Renesas QE for Motor" check box is selected in the "Install" dialog box, and click the "Next>" button.
6. Check that the "Renesas QE for Motor" check box is selected as the target of installation, and click the "Next>" button.
7. After confirming the license agreements, if you agree to the license, select the "I accept the terms of the license agreements" radio button, and click the "Finish" button.
8. If the dialog of the trust certificate is displayed, check that certificate, and click the "OK" button to continue installation.
9. When prompted to restart e² studio, restart it.
10. Start this product from the "Renesas Views" - "Renesas QE" menu of e² studio. For details about how to use this product, see the "Help" menu of e² studio.

2.1.2 Install using QE (zip file) downloaded from the Renesas website

1. Activate the e² studio.
2. Click on "Help", and then click on the "Install New Software..." menu item to open the "Install" dialog box.
3. Click on the "Add..." button to open the "Add Repository" dialog box.
4. Click on the "Archive..." button, select the installation file (zip file) in the opened file selection dialog box, and then click on the "Open" button.
5. Click on the "OK" button in the "Add Repository" dialog box.
6. Expand the "Renesas QE" item shown in the "Install" dialog box, select the "Renesas QE for Motor" check box, and then click on the "Next>" button.
* If you check off the "Contact all update sites during install to find required software" checkbox, you can shorten the installation time.
7. Confirm that the installation target is "Renesas QE for Motor", and then click on the "Next>" button.
8. After checking the license, select the "I accept the terms of the license agreements" radio button if you agree it, and then click on the "Finish" button.
9. When the dialog box for selecting a trusted certificate appears, check the displayed certificate, and then click on the "OK" button to continue installation.
10. Restart the e² studio by following the instructions on the screen.
11. Start this product from the "Renesas Views" - "Renesas QE" menu of the e² studio.
For details about how to use this product, see the "Help" menu of the e² studio.

2.2 Updating This Product

If you have already installed V1.0.0 of QE for Motor [RA] on your PC and wish to update it to V1.1.0 or a later version, select either of the following methods 2.2.1 or 2.2.2.

Note that the [Open the Update >>] link (shown below) in the [Motor Main (QE)] view of QE for Motor [RA] V1.0.0 cannot be used in updating that version to V1.1.0 or a later version.

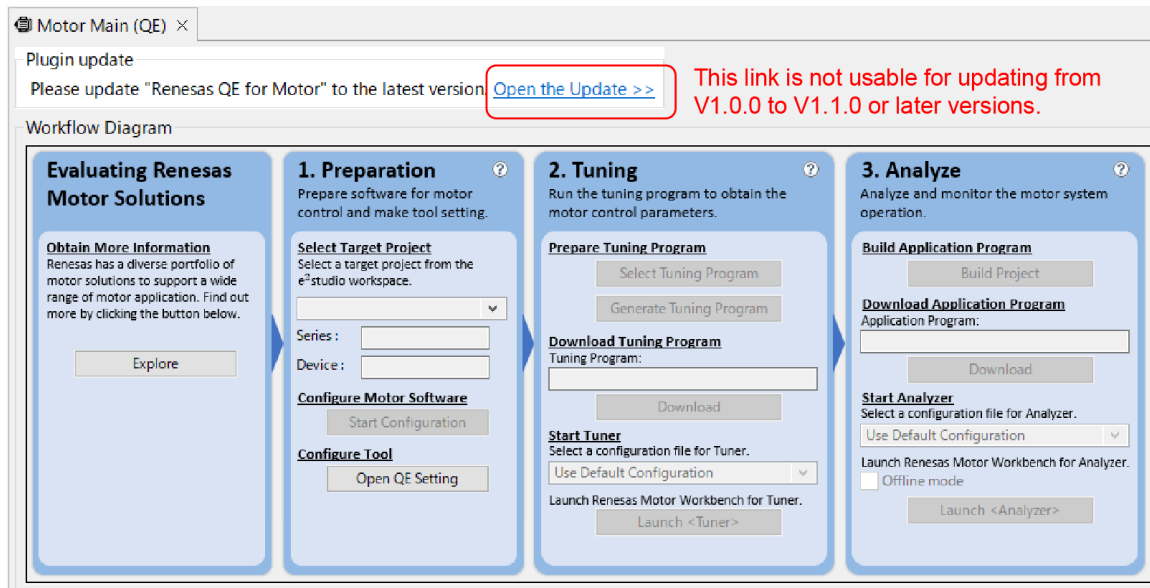

2.2.1 Download the latest version of QE for Motor from the Renesas Web site and install it

Follow the procedure below to download the latest version of QE for Motor from the Renesas Web site and install it.

1. Download the latest version of QE for Motor from the "QE for Motor" product page. Download the installation file of QE for Motor[RA] V1.1.0 from [QE for Motor](#)
2. Select the downloaded file to install QE for Motor. According to the instructions given on [QE: Tools for Particular Applications Information for Users | 1. Download and install QE from the web](#) page, click on the [Archive...] button on the [Add Repository] dialog box and select the .zip file you have downloaded in step 1.

2.2.2 Uninstall V1.0.0 of QE for Motor [RA] and use the Renesas Software Installer of the e² studio to install the latest version of QE for Motor

Follow the procedure below to uninstall V1.0.0 of QE for Motor [RA] and use the Renesas Software Installer of the e² studio to install the latest version of QE for Motor.

1. Uninstall V1.0.0 of QE for Motor [RA]. Uninstall V1.0.0 of QE for Motor [RA] according to the instructions given on the [QE: Tools for Particular Applications Information for Users | Uninstallation](#) page.
2. Use the Renesas Software Installer of the e² studio to install the latest version of QE for Motor. Install the latest version of QE for Motor according to the instructions given on the [QE: Tools for Particular Applications Information for Users | 2. Install QE from Renesas Software Installer in e² studio](#) page.

2.3 Uninstalling This Product

Follow the procedure below to uninstall this product.

1. Start the e² studio.
2. Select "Help -> About e² studio" to open the "About e² studio" dialog box.
3. Click the "Installation Details" button to open the "e² studio Installation Details" dialog box.
4. Select "Renesas QE for Motor" displayed on the "Installed Software" tabbed page and click on the "Uninstall..." button to open the "Uninstall" dialog box.
5. Check the displayed information and click on the "Finish" button.
6. When you are prompted to restart the e² studio, restart it.

3. Notes / Restrictions

3.1 Usage Considerations

Please pay attention to the following items.

3.1.1 Notes on the display of the [Motor Main (QE)] view

Floating the [Motor Main (QE)] view may not display the contents of the floating view.

Workaround:

Do not float the [Motor Main (QE)] view.

3.1.2 Notes on generating a tuning program

A tuning program cannot be downloaded to the target MCU and the tuner of Renesas Motor Workbench cannot be launched when a tuning program is generated from the [Motor Main (QE)] view (*) using the following sample project supporting tuning program generation.

- RA6T2 Sensorless vector control for permanent magnet synchronous motor (Implementation)
e²studio project name : RA6T2_MCILV1_SPM_LESS_FOC_TUNER_E2S_V101
- RA6T2 Vector control for permanent magnet synchronous motor with encoder (Implementation)
e²studio project name : RA6T2_MCILV1_SPM_ENCD_FOC_TUNER_E2S_V101

* How to generate a tuning program from [Motor Main (QE)]

- (1) Click on [Select Tuning Program] button on [Motor Main (QE)] view to open the [Tuning Program Selection] dialog box.

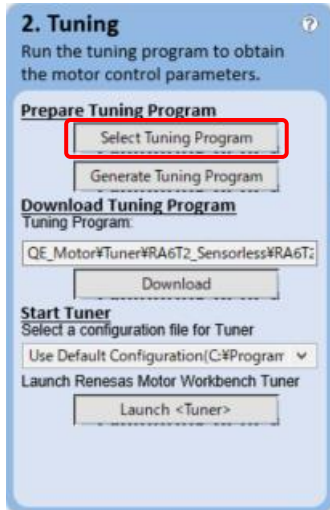

- (2) Select [Generate tuning program from tuning project] on [Tuning Program] radio button and select the project used for generating tuning program in the combo box. Click on [Finish] button to close the dialog box.
(Import the project used for generating tuning program into e²studio workspace beforehand.)

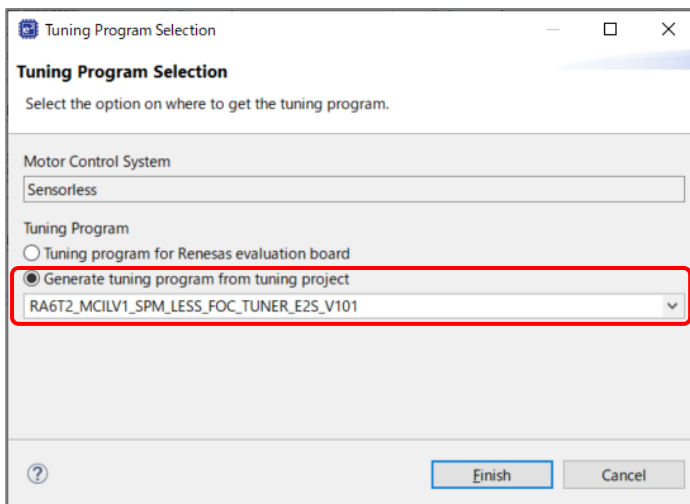

- (3) Click on [Generate Tuning Program] button in [Motor Main (QE)] view.

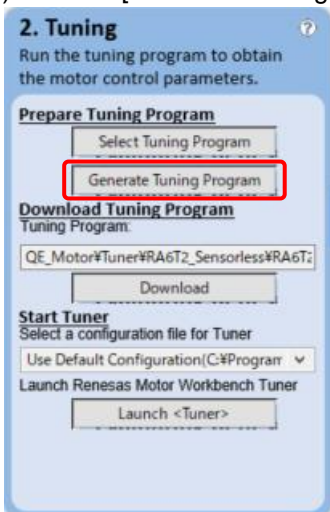

Workaround:

After clicking on [Generate Tuning Program] button on [Motor Main (QE)] view, on the project explorer of e²studio, copy the files used for tuning (.map, .elf, .sbd) to QE_Motor\Tuner\

Project for tuning program generation

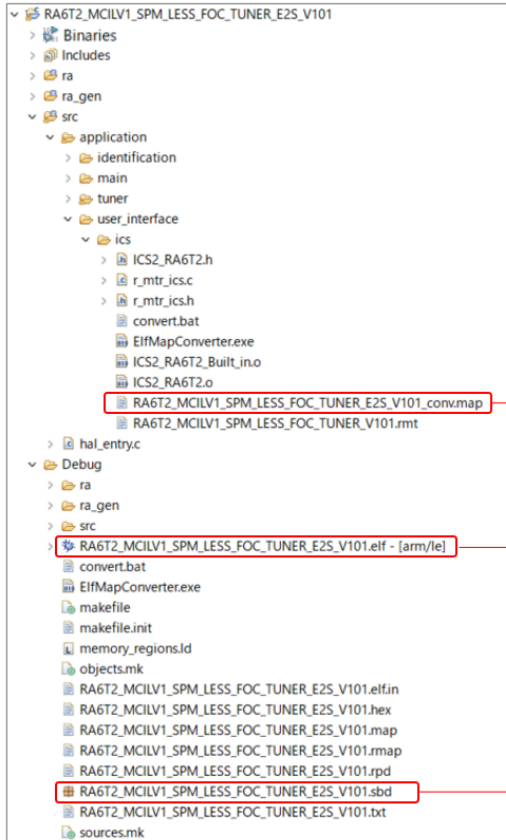

Target project

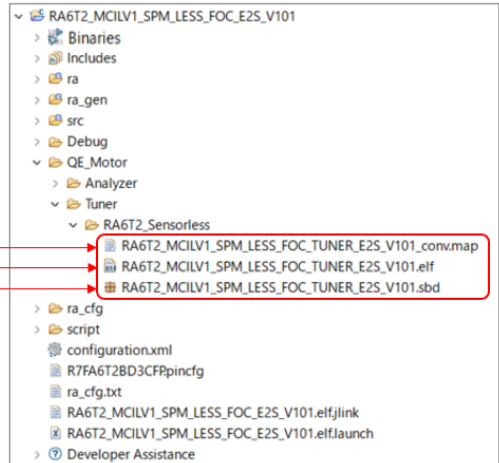

3.2 Functional Restrictions

There is no restriction.

Revision History

Rev.	Date	Description	
		Page	Summary
1.00	Jul.01.22	-	First edition issued.
1.01	Aug.08.22	8	2.2 Updating This Product, changed
1.02	Dec.02.22	9	Added 3.1.2 Notes on generating a tuning program

General Precautions in the Handling of Microprocessing Unit and Microcontroller Unit Products

The following usage notes are applicable to all Microprocessing unit and Microcontroller unit products from Renesas. For detailed usage notes on the products covered by this document, refer to the relevant sections of the document as well as any technical updates that have been issued for the products.

1. Precaution against Electrostatic Discharge (ESD)

A strong electrical field, when exposed to a CMOS device, can cause destruction of the gate oxide and ultimately degrade the device operation. Steps must be taken to stop the generation of static electricity as much as possible, and quickly dissipate it when it occurs. Environmental control must be adequate. When it is dry, a humidifier should be used. This is recommended to avoid using insulators that can easily build up static electricity. Semiconductor devices must be stored and transported in an anti-static container, static shielding bag or conductive material. All test and measurement tools including work benches and floors must be grounded. The operator must also be grounded using a wrist strap. Semiconductor devices must not be touched with bare hands. Similar precautions must be taken for printed circuit boards with mounted semiconductor devices.

2. Processing at power-on

The state of the product is undefined at the time when power is supplied. The states of internal circuits in the LSI are indeterminate and the states of register settings and pins are undefined at the time when power is supplied. In a finished product where the reset signal is applied to the external reset pin, the states of pins are not guaranteed from the time when power is supplied until the reset process is completed. In a similar way, the states of pins in a product that is reset by an on-chip power-on reset function are not guaranteed from the time when power is supplied until the power reaches the level at which resetting is specified.

3. Input of signal during power-off state

Do not input signals or an I/O pull-up power supply while the device is powered off. The current injection that results from input of such a signal or I/O pull-up power supply may cause malfunction and the abnormal current that passes in the device at this time may cause degradation of internal elements. Follow the guideline for input signal during power-off state as described in your product documentation.

4. Handling of unused pins

Handle unused pins in accordance with the directions given under handling of unused pins in the manual. The input pins of CMOS products are generally in the high-impedance state. In operation with an unused pin in the open-circuit state, extra electromagnetic noise is induced in the vicinity of the LSI, an associated shoot-through current flows internally, and malfunctions occur due to the false recognition of the pin state as an input signal become possible.

5. Clock signals

After applying a reset, only release the reset line after the operating clock signal becomes stable. When switching the clock signal during program execution, wait until the target clock signal is stabilized. When the clock signal is generated with an external resonator or from an external oscillator during a reset, ensure that the reset line is only released after full stabilization of the clock signal. Additionally, when switching to a clock signal produced with an external resonator or by an external oscillator while program execution is in progress, wait until the target clock signal is stable.

6. Voltage application waveform at input pin

Waveform distortion due to input noise or a reflected wave may cause malfunction. If the input of the CMOS device stays in the area between V_{IL} (Max.) and V_{IH} (Min.) due to noise, for example, the device may malfunction. Take care to prevent chattering noise from entering the device when the input level is fixed, and also in the transition period when the input level passes through the area between V_{IL} (Max.) and V_{IH} (Min.).

7. Prohibition of access to reserved addresses

Access to reserved addresses is prohibited. The reserved addresses are provided for possible future expansion of functions. Do not access these addresses as the correct operation of the LSI is not guaranteed.

8. Differences between products

Before changing from one product to another, for example to a product with a different part number, confirm that the change will not lead to problems. The characteristics of a microprocessing unit or microcontroller unit products in the same group but having a different part number might differ in terms of internal memory capacity, layout pattern, and other factors, which can affect the ranges of electrical characteristics, such as characteristic values, operating margins, immunity to noise, and amount of radiated noise. When changing to a product with a different part number, implement a system-evaluation test for the given product.

Notice

1. Descriptions of circuits, software and other related information in this document are provided only to illustrate the operation of semiconductor products and application examples. You are fully responsible for the incorporation or any other use of the circuits, software, and information in the design of your product or system. Renesas Electronics disclaims any and all liability for any losses and damages incurred by you or third parties arising from the use of these circuits, software, or information.
2. Renesas Electronics hereby expressly disclaims any warranties against and liability for infringement or any other claims involving patents, copyrights, or other intellectual property rights of third parties, by or arising from the use of Renesas Electronics products or technical information described in this document, including but not limited to, the product data, drawings, charts, programs, algorithms, and application examples.
3. No license, express, implied or otherwise, is granted hereby under any patents, copyrights or other intellectual property rights of Renesas Electronics or others.
4. You shall be responsible for determining what licenses are required from any third parties, and obtaining such licenses for the lawful import, export, manufacture, sales, utilization, distribution or other disposal of any products incorporating Renesas Electronics products, if required.
5. You shall not alter, modify, copy, or reverse engineer any Renesas Electronics product, whether in whole or in part. Renesas Electronics disclaims any and all liability for any losses or damages incurred by you or third parties arising from such alteration, modification, copying or reverse engineering.
6. Renesas Electronics products are classified according to the following two quality grades: "Standard" and "High Quality". The intended applications for each Renesas Electronics product depends on the product's quality grade, as indicated below.

"Standard": Computers; office equipment; communications equipment; test and measurement equipment; audio and visual equipment; home electronic appliances; machine tools; personal electronic equipment; industrial robots; etc.

"High Quality": Transportation equipment (automobiles, trains, ships, etc.); traffic control (traffic lights); large-scale communication equipment; key financial terminal systems; safety control equipment; etc.

Unless expressly designated as a high reliability product or a product for harsh environments in a Renesas Electronics data sheet or other Renesas Electronics document, Renesas Electronics products are not intended or authorized for use in products or systems that may pose a direct threat to human life or bodily injury (artificial life support devices or systems; surgical implantations; etc.), or may cause serious property damage (space system; undersea repeaters; nuclear power control systems; aircraft control systems; key plant systems; military equipment; etc.). Renesas Electronics disclaims any and all liability for any damages or losses incurred by you or any third parties arising from the use of any Renesas Electronics product that is inconsistent with any Renesas Electronics data sheet, user's manual or other Renesas Electronics document.
7. No semiconductor product is absolutely secure. Notwithstanding any security measures or features that may be implemented in Renesas Electronics hardware or software products, Renesas Electronics shall have absolutely no liability arising out of any vulnerability or security breach, including but not limited to any unauthorized access to or use of a Renesas Electronics product or a system that uses a Renesas Electronics product. RENESAS ELECTRONICS DOES NOT WARRANT OR GUARANTEE THAT RENESAS ELECTRONICS PRODUCTS, OR ANY SYSTEMS CREATED USING RENESAS ELECTRONICS PRODUCTS WILL BE INVULNERABLE OR FREE FROM CORRUPTION, ATTACK, VIRUSES, INTERFERENCE, HACKING, DATA LOSS OR THEFT, OR OTHER SECURITY INTRUSION ("Vulnerability Issues"). RENESAS ELECTRONICS DISCLAIMS ANY AND ALL RESPONSIBILITY OR LIABILITY ARISING FROM OR RELATED TO ANY VULNERABILITY ISSUES. FURTHERMORE, TO THE EXTENT PERMITTED BY APPLICABLE LAW, RENESAS ELECTRONICS DISCLAIMS ANY AND ALL WARRANTIES, EXPRESS OR IMPLIED, WITH RESPECT TO THIS DOCUMENT AND ANY RELATED OR ACCOMPANYING SOFTWARE OR HARDWARE, INCLUDING BUT NOT LIMITED TO THE IMPLIED WARRANTIES OF MERCHANTABILITY, OR FITNESS FOR A PARTICULAR PURPOSE.
8. When using Renesas Electronics products, refer to the latest product information (data sheets, user's manuals, application notes, "General Notes for Handling and Using Semiconductor Devices" in the reliability handbook, etc.), and ensure that usage conditions are within the ranges specified by Renesas Electronics with respect to maximum ratings, operating power supply voltage range, heat dissipation characteristics, installation, etc. Renesas Electronics disclaims any and all liability for any malfunctions, failure or accident arising out of the use of Renesas Electronics products outside of such specified ranges.
9. Although Renesas Electronics endeavors to improve the quality and reliability of Renesas Electronics products, semiconductor products have specific characteristics, such as the occurrence of failure at a certain rate and malfunctions under certain use conditions. Unless designated as a high reliability product or a product for harsh environments in a Renesas Electronics data sheet or other Renesas Electronics document, Renesas Electronics products are not subject to radiation resistance design. You are responsible for implementing safety measures to guard against the possibility of bodily injury, injury or damage caused by fire, and/or danger to the public in the event of a failure or malfunction of Renesas Electronics products, such as safety design for hardware and software, including but not limited to redundancy, fire control and malfunction prevention, appropriate treatment for aging degradation or any other appropriate measures. Because the evaluation of microcomputer software alone is very difficult and impractical, you are responsible for evaluating the safety of the final products or systems manufactured by you.
10. Please contact a Renesas Electronics sales office for details as to environmental matters such as the environmental compatibility of each Renesas Electronics product. You are responsible for carefully and sufficiently investigating applicable laws and regulations that regulate the inclusion or use of controlled substances, including without limitation, the EU RoHS Directive, and using Renesas Electronics products in compliance with all these applicable laws and regulations. Renesas Electronics disclaims any and all liability for damages or losses occurring as a result of your noncompliance with applicable laws and regulations.
11. Renesas Electronics products and technologies shall not be used for or incorporated into any products or systems whose manufacture, use, or sale is prohibited under any applicable domestic or foreign laws or regulations. You shall comply with any applicable export control laws and regulations promulgated and administered by the governments of any countries asserting jurisdiction over the parties or transactions.
12. It is the responsibility of the buyer or distributor of Renesas Electronics products, or any other party who distributes, disposes of, or otherwise sells or transfers the product to a third party, to notify such third party in advance of the contents and conditions set forth in this document.
13. This document shall not be reprinted, reproduced or duplicated in any form, in whole or in part, without prior written consent of Renesas Electronics.
14. Please contact a Renesas Electronics sales office if you have any questions regarding the information contained in this document or Renesas Electronics products.

(Note1) "Renesas Electronics" as used in this document means Renesas Electronics Corporation and also includes its directly or indirectly controlled subsidiaries.

(Note2) "Renesas Electronics product(s)" means any product developed or manufactured by or for Renesas Electronics.

(Rev.5.0-1 October 2020)

Corporate Headquarters

TOYOSU FORESIA, 3-2-24 Toyosu,
Koto-ku, Tokyo 135-0061, Japan
www.renesas.com

Trademarks

Renesas and the Renesas logo are trademarks of Renesas Electronics Corporation. All trademarks and registered trademarks are the property of their respective owners.

Contact information

For further information on a product, technology, the most up-to-date version of a document, or your nearest sales office, please visit:
www.renesas.com/contact/.