

ISL32450E, ISL32452E, ISL32453E, ISL32455E, ISL32457E, ISL32458E, ISL32459E
 ±60V Fault Protected, 3.3V to 5V, ±20V Common-Mode Range, RS-485/RS-422
 Transceivers with Cable Invert and ±15kV ESD

FN7921
 Rev.3.00
 Feb 14, 2019

The [ISL32450E](#), [ISL32452E](#), [ISL32453E](#), [ISL32455E](#), [ISL32457E](#), [ISL32458E](#), and [ISL32459E](#) are 3.3V to 5V powered, fault protected, extended Common-Mode Range (CMR) differential transceivers for balanced communication. The RS-485 bus pins (driver outputs and receiver inputs) are protected against overvoltages up to ±60V, and against ±15kV ESD strikes. These transceivers operate in environments with common-mode voltages up to ±20V (exceeds the RS-485 requirement), making this RS-485 family one of the most robust on the market.

The transmitters are RS-485 compliant with $V_{CC} \geq 4.5V$ and deliver a 1.1V differential output voltage into the RS-485 specified 54Ω load even with $V_{CC} = 3V$. The receiver (Rx) inputs feature a full fail-safe design that ensures a logic-high Rx output if the Rx inputs are floating, shorted, or on a terminated but undriven (idle) bus. The Rx full fail-safe operation is maintained even when the Rx input polarity is switched (cable invert function on ISL32457E and ISL32459E).

The ISL32457E and ISL32459E include a cable invert function that reverses the polarity of the Rx and Tx bus pins in case the cable is misconnected during installation.

See [Table 1 on page 4](#) for key features and configurations by device number.

Related Literature

- [ISL32450E](#), [ISL32452E](#), [ISL32453E](#), [ISL32455E](#), [ISL32457E](#), [ISL32458E](#), and [ISL32459E](#) device pages

Features

- Fault protected RS-485 bus pins up to ±60V
- Extended common-mode range. ±20V larger than required for RS-485
- ±15kV HBM ESD protection on RS-485 bus pins
- Wide supply range 3V to 5.5V
- Cable invert pin (ISL32457E and ISL32459E only) corrects for reversed cable connections while maintaining Rx full fail-safe functionality
- 1/4 unit load for up to 128 devices on the bus
- High transient overvoltage tolerance. ±80V
- Full fail-safe (open, short, terminated) RS-485 receivers
- Choice of RS-485 data rates up to 20Mbps
- Low quiescent supply current. 2.1mA

Applications

- Utility meters and automated meter reading systems
- Air conditioning systems
- Security camera networks
- Building lighting and environmental control systems
- Industrial and process control networks

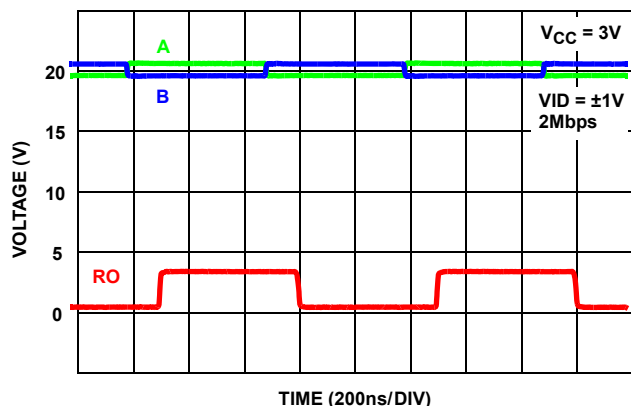

FIGURE 1. EXCEPTIONAL ISL32453E RX OPERATES AT >1Mbps EVEN WITH ±20V COMMON-MODE VOLTAGE

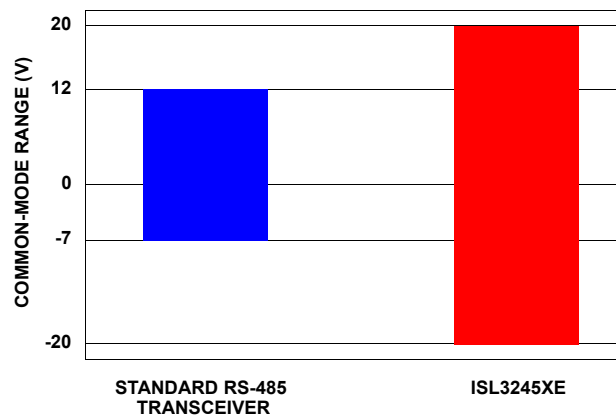

FIGURE 2. TRANSCEIVERS DELIVER SUPERIOR COMMON-MODE RANGE vs STANDARD RS-485 DEVICES

Typical Operating Circuits

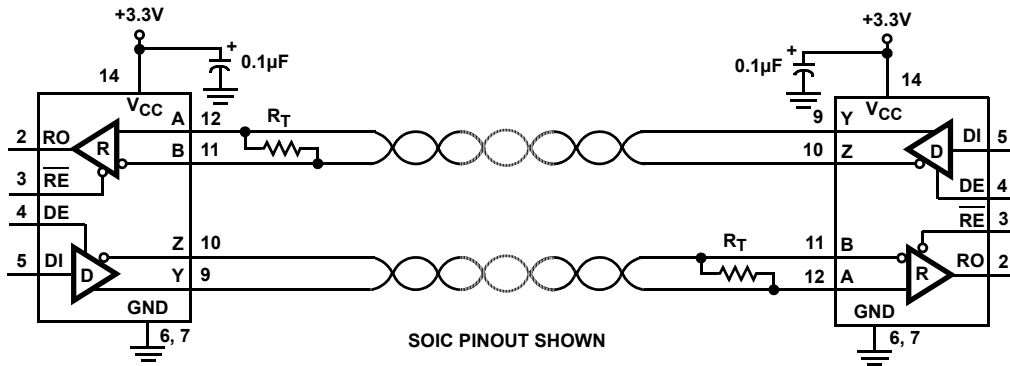

FIGURE 3. ISL32450E, ISL32453E FULL DUPLEX NETWORK

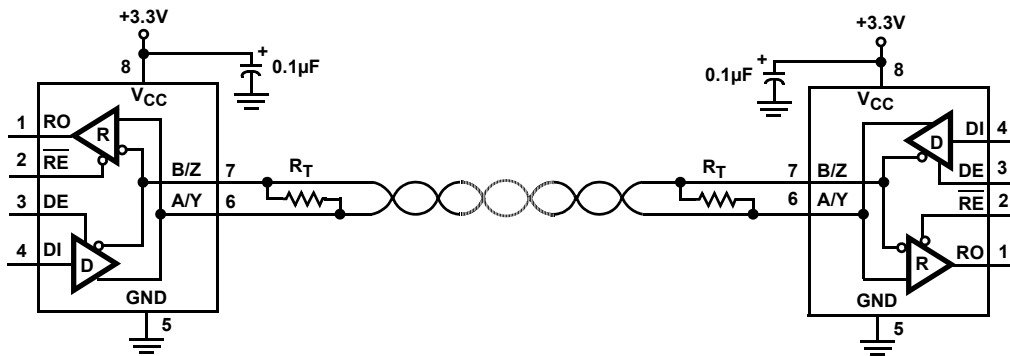

FIGURE 4. ISL32452E, ISL32455E, ISL32458E HALF DUPLEX NETWORK

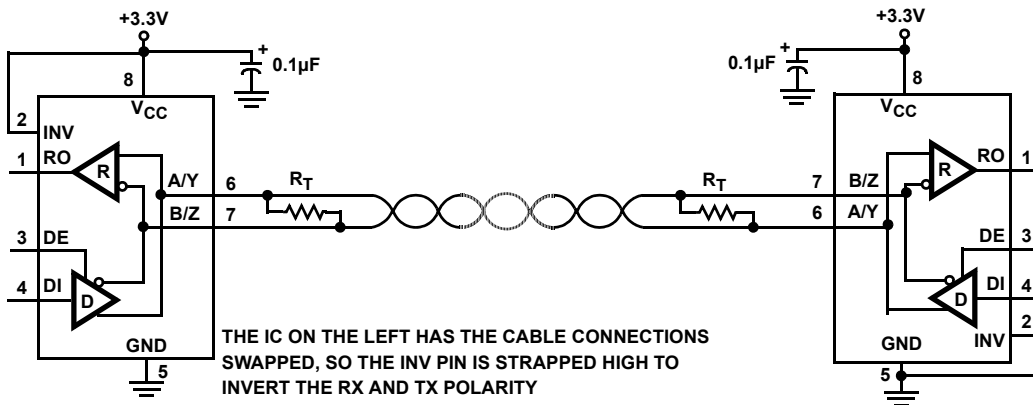

FIGURE 5. ISL32457E, ISL32459E HALF DUPLEX NETWORK USING CABLE INVERT FUNCTION

Ordering Information

PART NUMBER (Notes 2, 3)	PART MARKING	TEMP. RANGE (°C)	TAPE AND REEL (Units) (Note 1)	PACKAGE (RoHS Compliant)	PKG. DWG. #
ISL32450EIBZ	ISL32450 EIBZ	-40 to +85	-	14 Ld SOIC	M14.15
ISL32450EIBZ-T	ISL32450 EIBZ	-40 to +85	2.5k	14 Ld SOIC	M14.15
ISL32450EIBZ-T7A	ISL32450 EIBZ	-40 to +85	250	14 Ld SOIC	M14.15
ISL32450EIUZ	2450E	-40 to +85	-	10 Ld MSOP	M10.118
ISL32450EIUZ-T	2450E	-40 to +85	2.5k	10 Ld MSOP	M10.118
ISL32450EIUZ-T7A	2450E	-40 to +85	250	10 Ld MSOP	M10.118
ISL32452EIBZ	32452 EIBZ	-40 to +85	-	8 Ld SOIC	M8.15
ISL32452EIBZ-T	32452 EIBZ	-40 to +85	2.5k	8 Ld SOIC	M8.15
ISL32452EIBZ-T7A	32452 EIBZ	-40 to +85	250	8 Ld SOIC	M8.15
ISL32452EIUZ	2452E	-40 to +85	-	8 Ld MSOP	M8.118
ISL32452EIUZ-T	2452E	-40 to +85	2.5k	8 Ld MSOP	M8.118
ISL32452EIUZ-T7A	2452E	-40 to +85	250	8 Ld MSOP	M8.118
ISL32453EIBZ	ISL32453 EIBZ	-40 to +85	-	14 Ld SOIC	M14.15
ISL32453EIBZ-T	ISL32453 EIBZ	-40 to +85	2.5k	14 Ld SOIC	M14.15
ISL32453EIBZ-T7A	ISL32453 EIBZ	-40 to +85	250	14 Ld SOIC	M14.15
ISL32453EIUZ	2453E	-40 to +85	-	10 Ld MSOP	M10.118
ISL32453EIUZ-T	2453E	-40 to +85	2.5k	10 Ld MSOP	M10.118
ISL32453EIUZ-T7A	2453E	-40 to +85	250	10 Ld MSOP	M10.118
ISL32455EIBZ	32455 EIBZ	-40 to +85	-	8 Ld SOIC	M8.15
ISL32455EIBZ-T	32455 EIBZ	-40 to +85	2.5k	8 Ld SOIC	M8.15
ISL32455EIBZ-T7A	32455 EIBZ	-40 to +85	250	8 Ld SOIC	M8.15
ISL32455EIUZ	2455E	-40 to +85	-	8 Ld MSOP	M8.118
ISL32455EIUZ-T	2455E	-40 to +85	2.5k	8 Ld MSOP	M8.118
ISL32455EIUZ-T7A	2455E	-40 to +85	250	8 Ld MSOP	M8.118
ISL32457EIBZ	32457 EIBZ	-40 to +85	-	8 Ld SOIC	M8.15
ISL32457EIBZ-T	32457 EIBZ	-40 to +85	2.5k	8 Ld SOIC	M8.15
ISL32457EIBZ-T7A	32457 EIBZ	-40 to +85	250	8 Ld SOIC	M8.15
ISL32457EIUZ	2457E	-40 to +85	-	8 Ld MSOP	M8.118
ISL32457EIUZ-T	2457E	-40 to +85	2.5k	8 Ld MSOP	M8.118
ISL32457EIUZ-T7A	2457E	-40 to +85	250	8 Ld MSOP	M8.118
ISL32458EIBZ	32458 EIBZ	-40 to +85	-	8 Ld SOIC	M8.15
ISL32458EIBZ-T	32458 EIBZ	-40 to +85	2.5k	8 Ld SOIC	M8.15
ISL32458EIBZ-T7A	32458 EIBZ	-40 to +85	250	8 Ld SOIC	M8.15

Ordering Information (Continued)

PART NUMBER (Notes 2, 3)	PART MARKING	TEMP. RANGE (°C)	TAPE AND REEL (Units) (Note 1)	PACKAGE (RoHS Compliant)	PKG. DWG. #
ISL32459EIBZ	32459 EIBZ	-40 to +85	-	8 Ld SOIC	M8.15
ISL32459EIBZ-T	32459 EIBZ	-40 to +85	2.5k	8 Ld SOIC	M8.15
ISL32459EIBZ-T7A	32459 EIBZ	-40 to +85	250	8 Ld SOIC	M8.15

NOTES:

- See [TB347](#) for details about reel specifications.
- These Pb-free plastic packaged products employ special Pb-free material sets, molding compounds/die attach materials, and 100% matte tin plate plus anneal (e3 termination finish, which is RoHS compliant and compatible with both SnPb and Pb-free soldering operations). Pb-free products are MSL classified at Pb-free peak reflow temperatures that meet or exceed the Pb-free requirements of IPC/JEDEC J STD-020.
- For Moisture Sensitivity Level (MSL), see the [ISL32450E](#), [ISL32452E](#), [ISL32453E](#), [ISL32455E](#), [ISL32457E](#), [ISL32458E](#), [ISL32459E](#) device pages. For more information about MSL, see [TB363](#).

TABLE 1. SUMMARY OF FEATURES

PART NUMBER	HALF/FULL DUPLEX	DATA RATE (Mbps)	SLEW-RATE LIMITED?	EN PINS?	HOT PLUG	CABLE INVERT (INV) PIN?	QUIESCENT I _{CC} (mA)	LOW POWER SHUTDOWN?	PIN COUNT
ISL32450E	Full	0.25	Yes	Yes	No	No	2.1	Yes	10, 14
ISL32452E	Half	0.25	Yes	Yes	No	No	2.1	Yes	8
ISL32453E	Full	1	Yes	Yes	No	No	2.1	Yes	10, 14
ISL32455E	Half	1	Yes	Yes	No	No	2.1	Yes	8
ISL32457E	Half	0.25	Yes	Tx Only	No	Yes	2.1	No	8
ISL32458E	Half	20	No	Yes	No	No	2.1	Yes	8
ISL32459E	Half	20	No	Tx Only	No	Yes	2.1	No	8

Pin Configurations

ISL32450E, ISL32453E
(14 LD SOIC)
TOP VIEW

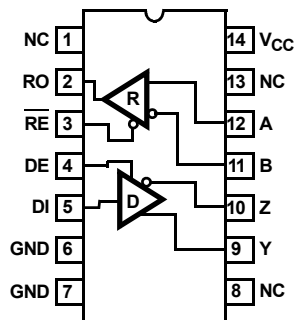

ISL32450E, ISL32453E
(10 LD MSOP)
TOP VIEW

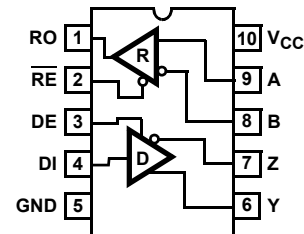

ISL32452E, ISL32455E, ISL32458E
(8 LD SOIC, 8 LD MSOP)
TOP VIEW

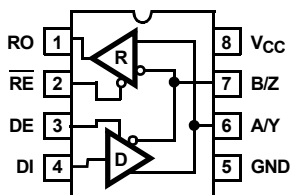

ISL32457E, ISL32459E
(8 LD SOIC, 8 LD MSOP)
TOP VIEW

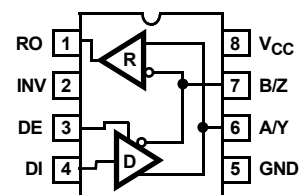

NOTE: Evaluate creepage and clearance requirements at your maximum fault voltage before using small pitch packages, such as MSOP.

Pin Descriptions

PIN NAME	ISL32450E, ISL32453E, (14 LD SOIC) PIN #	ISL32450E, ISL32453E, (10 LD MSOP) PIN #	ISL32452E, ISL32455E, ISL32458E (8 LD SOIC, 8 LD MSOP) PIN #	ISL32457E, ISL32459E (8 LD SOIC, 8 LD MSOP) PIN #	FUNCTION
RO	2	1	1	1	Receiver output. For parts without the cable invert function - or if INV is low - then: If $A - B \geq -10\text{mV}$, RO is high; if $A - B \leq -200\text{mV}$, RO is low. If INV is high, then: If $B - A \geq -10\text{mV}$, RO is high; if $B - A \leq -200\text{mV}$, RO is low. In all cases, RO = High if A and B are unconnected (floating), or shorted together, or connected to an undriven, terminated bus (that is, Rx is always fail-safe open, shorted and idle, even if polarity is inverted).
$\overline{\text{RE}}$	3	2	2	N/A	Receiver output enable. RO is enabled when $\overline{\text{RE}}$ is low; RO is high impedance when $\overline{\text{RE}}$ is high. Internally pulled low.
DE	4	3	3	3	Driver output enable. The driver outputs, Y and Z, are enabled by bringing DE high and they are high impedance when DE is low. Internally pulled high.
DI	5	4	4	4	Driver input. For parts without the cable invert function - or if INV is low - a low on DI forces output Y low and output Z high, while a high on DI forces output Y high and output Z low. The output states, relative to DI, invert if INV is high.
GND	6, 7	5	5	5	Ground connection.
A/Y	N/A	N/A	6	6	$\pm 60\text{V}$ fault protected and $\pm 16.5\text{kV}$ ESD protected RS-485/RS-422 I/O pin. For parts without the cable invert function - or if INV is low - A/Y is the noninverting receiver input and noninverting driver output. If INV is high, A/Y is the inverting receiver input and the inverting driver output. Pin is an input if DE = 0; pin is an output if DE = 1.
B/Z	N/A	N/A	7	7	$\pm 60\text{V}$ fault protected and $\pm 16.5\text{kV}$ ESD protected RS-485/RS-422 I/O pin. For parts without the cable invert function - or if INV is low - B/Z is the inverting receiver input and inverting driver output. If INV is high, B/Z is the noninverting receiver input and the noninverting driver output. Pin is an input if DE = 0; pin is an output if DE = 1.
A	12	9	N/A	N/A	$\pm 60\text{V}$ fault protected and $\pm 15\text{kV}$ ESD protected RS-485/RS-422 noninverting receiver input.
B	11	8	N/A	N/A	$\pm 60\text{V}$ fault protected and $\pm 15\text{kV}$ ESD protected RS-485/RS-422 inverting receiver input.
Y	9	6	N/A	N/A	$\pm 60\text{V}$ fault protected and $\pm 15\text{kV}$ ESD protected RS-485/RS-422 noninverting driver output.
Z	10	7	N/A	N/A	$\pm 60\text{V}$ fault protected and $\pm 15\text{kV}$ ESD protected RS-485/RS-422 inverting driver output.
V _{CC}	14	10	8	8	System power supply input (3V to 5.5V).
INV	N/A	N/A	N/A	2	Receiver and driver cable invert (polarity selection) input. When driven high this pin swaps the polarity of the driver output and receiver input pins. If unconnected (floating) or connected low, normal RS-485 polarity conventions apply. Internally pulled low.
NC	1, 8, 13	N/A	N/A	N/A	No internal connection.

Truth Tables

TRANSMITTING					
INPUTS				OUTPUTS	
\overline{RE}	DE	DI	INV (Note 4)	Y	Z
X	1	1	0	1	0
X	1	0	0	0	1
X	1	1	1	0	1
X	1	0	1	1	0
0	0	X	X	High-Z	High-Z
1	0	X	X	High-Z (Note 5)	High-Z (Note 5)

NOTES:

4. Parts without the INV pin follow the rows with INV = "0" and "X".
5. Low Power Shutdown mode (see [Notes 14](#) and [19](#)).

RECEIVING					
INPUTS					OUTPUT
\overline{RE} (Note 19)	DE Half Duplex	DE Full Duplex	A-B	INV (Note 4)	RO
0	0	X	$V_{AB} \geq -0.01V$	0	1
0	0	X	$-0.01V > V_{AB} > -0.2V$	0	Undetermined
0	0	X	$V_{AB} \leq -0.2V$	0	0
0	0	X	$V_{AB} \leq 0.01V$	1	1
0	0	X	$0.01V < V_{AB} < 0.2V$	1	Undetermined
0	0	X	$\geq 0.2V$	1	0
0	0	X	Inputs Open or Shorted	X	1
1	0	0	X	X	High-Z (Note 5)
1	1	1	X	X	High-Z

Absolute Maximum Ratings

V _{CC} to Ground	7V
Input Voltages	
DI, DE, RE, INV	-0.3V to V _{CC} + 0.3V
Input/Output Voltages	
A/Y, B/Z, A, B, Y, Z	±60V
A/Y, B/Z, A, B, Y, Z	
(Transient Pulse Through 100Ω, Note 6)	±80V
RO	-0.3V to (V _{CC} + 0.3V)
Short-Circuit Duration	
Y, Z	Indefinite
ESD Rating	see " ESD PERFORMANCE " on page 8
Latch-Up (per JESD78, Level 2, Class A)	+125°C

Thermal Information

Thermal Resistance (Typical)	θ _{JA} (°C/W)	θ _{JC} (°C/W)
8 Ld SOIC Package (Notes 7, 8)	108	47
8 Ld MSOP Package (Notes 7, 8)	140	40
10 Ld MSOP Package (Notes 7, 8)	135	50
14 Ld SOIC Package (Notes 7, 8)	88	39
Maximum Junction Temperature (Plastic Package)	+150°C	
Maximum Storage Temperature Range	-65°C to +150°C	
Pb-Free Reflow Profile	see TB493	

Recommended Operating Conditions

Supply Voltage (V _{CC})	3.3V or 5V
Temperature Range	-40°C to +85°C
Bus Pin Common-Mode Voltage Range	-20V to +20V

CAUTION: Do not operate at or near the maximum ratings listed for extended periods of time. Exposure to such conditions can adversely impact product reliability and result in failures not covered by warranty.

NOTES:

- Tested according to TIA/EIA-485-A, Section 4.2.6 (±80V for 15μs at a 1% duty cycle).
- θ_{JA} is measured with the component mounted on a high-effective thermal conductivity test board in free air. See [TB379](#) for details.
- For θ_{JC}, the "case temp" location is taken at the package top center.

Electrical Specifications Test Conditions: V_{CC} = 3V to 3.6V and 4.5V to 5.5V, unless otherwise specified. Typical values are at the worst case of V_{CC} = 5V or V_{CC} = 3.3V, T_A = +25°C ([Note 9](#)). **Boldface limits apply across the operating temperature range, -40°C to +85°C.**

PARAMETER	SYMBOL	TEST CONDITIONS	TEMP (°C)	MIN (Note 17)	TYP	MAX (Note 17)	UNIT	
DC CHARACTERISTICS								
Driver Differential V _{OUT} (No load)	V _{OD1}		Full	-	-	V_{CC}	V	
Driver Differential V _{OUT} (Loaded, Figure 6A)	V _{OD2}	R _L = 100Ω (RS-422), V _{CC} ≥ 4.5V	Full	2	3	-	V	
		R _L = 54Ω (RS-485)	V _{CC} ≥ 4.5V	Full	1.7	2.3	V_{CC}	V
			V _{CC} ≥ 3V	Full	1.1	1.3	V_{CC}	V
Change in Magnitude of Driver Differential V _{OUT} for Complementary Output States	ΔV _{OD}	R _L = 54Ω or 100Ω (Figure 6A)	Full	-	-	0.2	V	
Driver Differential V _{OUT} with Common-Mode Load (Figure 6B)	V _{OD3}	R _L = 60Ω, -20V ≤ V _{CM} ≤ 20V, V _{CC} ≥ 4.5V	Full	1.5	-	-	V	
Driver Common-Mode V _{OUT} (Figure 6A)	V _{OC}	R _L = 54Ω or 100Ω	Full	-1	-	3	V	
Change in Magnitude of Driver Common-Mode V _{OUT} for Complementary Output States	ΔV _{OC}	R _L = 54Ω or 100Ω (Figure 6A)	Full	-	-	0.2	V	
Driver Short-Circuit Current	I _{OSD}	DE = V _{CC} , -20V ≤ V _O ≤ 20V (Note 11)	Full	-250	-	250	mA	
	I _{OSD1}	At first foldback, 24V ≤ V _O ≤ -24V	Full	-83	-	83	mA	
	I _{OSD2}	At second foldback, 35V ≤ V _O ≤ -35V	Full	-13	-	13	mA	
Logic Input High Voltage	V _{IH}	DE, DI, RE, INV (See Figure 33)	Full	2.35	-	-	V	
Logic Input Low Voltage	V _{IL}	DE, DI, RE, INV	Full	-	-	0.8	V	
Logic Input Current	I _{IN1}	DI	Full	-1	-	1	μA	
		DE, RE, INV	Full	-15	6	15	μA	

Electrical Specifications Test Conditions: $V_{CC} = 3V$ to $3.6V$ and $4.5V$ to $5.5V$, unless otherwise specified. Typicals are at the worst case of $V_{CC} = 5V$ or $V_{CC} = 3.3V$, $T_A = +25^\circ C$ (Note 9). **Boldface limits apply across the operating temperature range, $-40^\circ C$ to $+85^\circ C$.** (Continued)

PARAMETER	SYMBOL	TEST CONDITIONS	TEMP (°C)	MIN (Note 17)	TYP	MAX (Note 17)	UNIT	
Input/Output Current (A/Y, B/Z)	I_{IN2}	DE = 0V, $V_{CC} = 0V$ or 3.6V or 5.5V	$V_{IN} = 12V$	Full	-	-	250	μA
			$V_{IN} = -7V$	Full	-200	-	-	μA
			$V_{IN} = \pm 20V$	Full	-800	-	850	μA
			$V_{IN} = \pm 60V$, (Note 18)	Full	-6	-	6	mA
Input Current (A, B) (Full Duplex Versions Only)	I_{IN3}	$V_{CC} = 0V$ or 3.6V or 5.5V	$V_{IN} = 12V$	Full	-	-	125	μA
			$V_{IN} = -7V$	Full	-100	-	-	μA
			$V_{IN} = \pm 20V$	Full	-500	-	500	μA
			$V_{IN} = \pm 60V$, (Note 18)	Full	-3	-	3	mA
Output Leakage Current (Y, Z) (Full Duplex Versions Only)	I_{OZD}	$\overline{RE} = 0V$, DE = 0V, $V_{CC} = 0V$ or 3.6V or 5.5V	$V_{IN} = 12V$	Full	-	-	200	μA
			$V_{IN} = -7V$	Full	-100	-	-	μA
			$V_{IN} = \pm 20V$	Full	-500	-	500	μA
			$V_{IN} = \pm 60V$, (Note 18)	Full	-3	-	3	mA
Receiver Differential Threshold Voltage	V_{TH}	-20V $\leq V_{CM} \leq 20V$, (For ISL32457E and ISL32459E only, A-B if INV = 0; B-A if INV = 1)	$V_{CC} \leq 3.6V$	Full	-200	-120	-10	mV
			$V_{CC} \geq 4.5V$	Full	-250	-180	-10	mV
Receiver Input Hysteresis	ΔV_{TH}	-20V $\leq V_{CM} \leq 20V$	+25	-	30	-	mV	
Receiver Output High Voltage	V_{OH1}	$V_{ID} = -10mV$	$I_O = -4mA$, $V_{CC} \geq 3V$	Full	2.4	-	-	V
	V_{OH2}		$I_O = -8mA$, $V_{CC} \geq 4.5V$	Full	2.4	-	-	V
Receiver Output Low Voltage	V_{OL}	$I_O = 4mA$, $V_{CC} \geq 3V$, $V_{ID} = -200mV$		Full	-	-	0.4	V
			$I_O = 5mA$, $V_{CC} \geq 4.5V$, $V_{ID} = -250mV$	Full	-	-	0.4	V
Three-State (High Impedance) Receiver Output Current (Note 19)	I_{OZR}	$0V \leq V_O \leq V_{CC}$	Full	-1	0.01	1	μA	
Receiver Short-Circuit Current	I_{OSR}	$0V \leq V_O \leq V_{CC}$	Full	-	-	± 115	mA	
SUPPLY CURRENT								
No-Load Supply Current (Note 10)	I_{CC}	DE = V_{CC} , $\overline{RE} = 0V$ or V_{CC} , DI = 0V or V_{CC}	Full	-	2.1	4.5	mA	
Shutdown Supply Current (Note 19)	I_{SHDN}	DE = 0V, $\overline{RE} = V_{CC}$, DI = 0V or V_{CC}	Full	-	10	35	μA	
ESD PERFORMANCE								
All Pins		Human Body Model (ISL32450E, ISL32452E, ISL32453E, ISL32455E, ISL32457E; Tested per JESD22-A114E)	+25	-	± 8	-	kV	
			+25	-	± 3	-	kV	
			+25	-	± 700	-	V	
RS-485 Pins (A, B, Y, Z, A/Y, B/Z)		Human Body Model, from Bus Pins to GND	Full Duplex	+25	-	± 15	-	kV
			Half Duplex	+25	-	± 16.5	-	kV

Electrical Specifications Test Conditions: $V_{CC} = 3V$ to $3.6V$ and $4.5V$ to $5.5V$, unless otherwise specified. Typical values are at the worst case of $V_{CC} = 5V$ or $V_{CC} = 3.3V$, $T_A = +25^\circ C$ (Note 9). **Boldface limits apply across the operating temperature range, $-40^\circ C$ to $+85^\circ C$.** (Continued)

PARAMETER	SYMBOL	TEST CONDITIONS	TEMP ($^\circ C$)	MIN (Note 17)	TYP	MAX (Note 17)	UNIT
DRIVER SWITCHING CHARACTERISTICS (250kbps VERSIONS; ISL32450E, ISL32452E, ISL32457E)							
Driver Differential Output Delay	t_{PLH}, t_{PHL}	$R_D = 54\Omega, C_D = 50pF$ (Figure 7)	Full	-	280	1000	ns
Driver Differential Output Skew	t_{SKEW}	$R_D = 54\Omega, C_D = 50pF$ (Figure 7)	Full	-	4	100	ns
Driver Differential Rise or Fall Time	t_R, t_F	$R_D = 54\Omega, C_D = 50pF$ (Figure 7)	Full	250	650	1500	ns
Maximum Data Rate	f_{MAX}	$C_D = 820pF$ (Figure 9)	Full	250	-	-	kbps
Driver Enable to Output High	t_{ZH}	SW = GND (Figure 8), (Note 12)	Full	-	-	1600	ns
Driver Enable to Output Low	t_{ZL}	SW = V_{CC} (Figure 8), (Note 12)	Full	-	-	1600	ns
Driver Disable from Output Low	t_{LZ}	SW = V_{CC} (Figure 8)	Full	-	-	300	ns
Driver Disable from Output High	t_{HZ}	SW = GND (Figure 8)	Full	-	-	300	ns
Time to Shutdown	t_{SHDN}	(Notes 14, 19)	Full	60	160	600	ns
Driver Enable from Shutdown to Output High	$t_{ZH(SHDN)}$	SW = GND (Figure 8), (Notes 14, 15, 19)	Full	-	-	3000	ns
Driver Enable from Shutdown to Output Low	$t_{ZL(SHDN)}$	SW = V_{CC} (Figure 8), (Notes 14, 15, 19)	Full	-	-	3000	ns
DRIVER SWITCHING CHARACTERISTICS (1Mbps VERSIONS; ISL32453E, ISL32455E)							
Driver Differential Output Delay	t_{PLH}, t_{PHL}	$R_D = 54\Omega, C_D = 50pF$ (Figure 7)	Full	-	70	200	ns
Driver Differential Output Skew	t_{SKEW}	$R_D = 54\Omega, C_D = 50pF$ (Figure 7)	Full	-	4	25	ns
Driver Differential Rise or Fall Time	t_R, t_F	$R_D = 54\Omega, C_D = 50pF$ (Figure 7)	Full	50	130	300	ns
Maximum Data Rate	f_{MAX}	$C_D = 820pF$ (Figure 9)	Full	1	-	-	Mbps
Driver Enable to Output High	t_{ZH}	SW = GND (Figure 8), (Note 12)	Full	-	-	300	ns
Driver Enable to Output Low	t_{ZL}	SW = V_{CC} (Figure 8), (Note 12)	Full	-	-	300	ns
Driver Disable from Output Low	t_{LZ}	SW = V_{CC} (Figure 8)	Full	-	-	300	ns
Driver Disable from Output High	t_{HZ}	SW = GND (Figure 8)	Full	-	-	300	ns
Time to Shutdown	t_{SHDN}	(Note 14)	Full	60	160	600	ns
Driver Enable from Shutdown to Output High	$t_{ZH(SHDN)}$	SW = GND (Figure 8), (Notes 14, 15)	Full	-	-	3000	ns
Driver Enable from Shutdown to Output Low	$t_{ZL(SHDN)}$	SW = V_{CC} (Figure 8), (Notes 14, 15)	Full	-	-	3000	ns
DRIVER SWITCHING CHARACTERISTICS (20Mbps VERSIONS; ISL32458E, ISL32459E)							
Driver Differential Output Delay	t_{PLH}, t_{PHL}	$R_D = 54\Omega, C_D = 50pF$ (Figure 7)	Full	-	28	45	ns
Driver Differential Output Skew	t_{SKEW}	$R_D = 54\Omega, C_D = 50pF$ (Figure 7)	Full	-	3	9	ns
Driver Differential Rise or Fall Time	t_R, t_F	$R_D = 54\Omega, C_D = 50pF$ (Figure 7)	Full	-	17	35	ns
Maximum Data Rate	f_{MAX}	$C_D = 470pF$ (Figure 9)	Full	20	-	-	Mbps
Driver Enable to Output High	t_{ZH}	SW = GND (Figure 8), (Note 12)	Full	-	-	180	ns
Driver Enable to Output Low	t_{ZL}	SW = V_{CC} (Figure 8), (Note 12)	Full	-	-	180	ns
Driver Disable from Output Low	t_{LZ}	SW = V_{CC} (Figure 8)	Full	-	-	300	ns
Driver Disable from Output High	t_{HZ}	SW = GND (Figure 8)	Full	-	-	300	ns
Time to Shutdown	t_{SHDN}	(Notes 14, 19)	Full	60	160	600	ns
Driver Enable from Shutdown to Output High	$t_{ZH(SHDN)}$	SW = GND (Figure 8), (Notes 14, 15, 19)	Full	-	-	3000	ns

Electrical Specifications Test Conditions: $V_{CC} = 3V$ to $3.6V$ and $4.5V$ to $5.5V$, unless otherwise specified. Typicals are at the worst case of $V_{CC} = 5V$ or $V_{CC} = 3.3V$, $T_A = +25^\circ C$ (Note 9). **Boldface limits apply across the operating temperature range, $-40^\circ C$ to $+85^\circ C$.** (Continued)

PARAMETER	SYMBOL	TEST CONDITIONS	TEMP ($^\circ C$)	MIN (Note 17)	TYP	MAX (Note 17)	UNIT
Driver Enable from Shutdown to Output Low	$t_{ZL}(SHDN)$	$SW = V_{CC}$ (Figure 8), (Notes 14, 15, 19)	Full	-	-	3000	ns
RECEIVER SWITCHING CHARACTERISTICS (250kbps VERSIONS; ISL32450E, ISL32452E, ISL32457E)							
Maximum Data Rate	f_{MAX}	(Figure 10)	Full	250	-	-	kbps
Receiver Input to Output Delay	t_{PLH}, t_{PHL}	(Figure 10)	Full	-	240	325	ns
Receiver Skew $t_{PLH} - t_{PHL}$	t_{SKD}	(Figure 10)	Full	-	6	25	ns
Receiver Enable to Output Low	t_{ZL}	$R_L = 1k\Omega, C_L = 15pF, SW = V_{CC}$ (Figure 11), (Notes 13, 19)	Full	-	-	80	ns
Receiver Enable to Output High	t_{ZH}	$R_L = 1k\Omega, C_L = 15pF, SW = GND$ (Figure 11), (Notes 13, 19)	Full	-	-	80	ns
Receiver Disable from Output Low	t_{LZ}	$R_L = 1k\Omega, C_L = 15pF, SW = V_{CC}$ (Figure 11), (Note 19)	Full	-	-	80	ns
Receiver Disable from Output High	t_{HZ}	$R_L = 1k\Omega, C_L = 15pF, SW = GND$ (Figure 11), (Note 19)	Full	-	-	80	ns
Time to Shutdown	t_{SHDN}	(Notes 14, 19)	Full	60	160	600	ns
Receiver Enable from Shutdown to Output High	$t_{ZH}(SHDN)$	$R_L = 1k\Omega, C_L = 15pF, SW = GND$ (Figure 11), (Notes 14, 16, 19)	Full	-	-	2500	ns
Receiver Enable from Shutdown to Output Low	$t_{ZL}(SHDN)$	$R_L = 1k\Omega, C_L = 15pF, SW = V_{CC}$ (Figure 11), (Notes 14, 16, 19)	Full	-	-	2500	ns
RECEIVER SWITCHING CHARACTERISTICS (1Mbps VERSIONS; ISL32453E, ISL32455E)							
Maximum Data Rate	f_{MAX}	(Figure 10)	Full	1	-	-	Mbps
Receiver Input to Output Delay	t_{PLH}, t_{PHL}	(Figure 10)	Full	-	115	200	ns
Receiver Skew $t_{PLH} - t_{PHL}$	t_{SKD}	(Figure 10)	Full	-	4	20	ns
Receiver Enable to Output Low	t_{ZL}	$R_L = 1k\Omega, C_L = 15pF, SW = V_{CC}$ (Figure 11), (Note 13)	Full	-	-	80	ns
Receiver Enable to Output High	t_{ZH}	$R_L = 1k\Omega, C_L = 15pF, SW = GND$ (Figure 11), (Note 13)	Full	-	-	80	ns
Receiver Disable from Output Low	t_{LZ}	$R_L = 1k\Omega, C_L = 15pF, SW = V_{CC}$ (Figure 11)	Full	-	-	80	ns
Receiver Disable from Output High	t_{HZ}	$R_L = 1k\Omega, C_L = 15pF, SW = GND$ (Figure 11)	Full	-	-	80	ns
Time to Shutdown	t_{SHDN}	(Note 14)	Full	60	160	600	ns
Receiver Enable from Shutdown to Output High	$t_{ZH}(SHDN)$	$R_L = 1k\Omega, C_L = 15pF, SW = GND$ (Figure 11), (Notes 14, 16)	Full	-	-	2500	ns
Receiver Enable from Shutdown to Output Low	$t_{ZL}(SHDN)$	$R_L = 1k\Omega, C_L = 15pF, SW = V_{CC}$ (Figure 11), (Notes 14, 16)	Full	-	-	2500	ns
RECEIVER SWITCHING CHARACTERISTICS (20Mbps VERSIONS; ISL32458E, ISL32459E)							
Maximum Data Rate	f_{MAX}	(Figure 10)	Full	20	-	-	Mbps
Receiver Input to Output Delay	t_{PLH}, t_{PHL}	(Figure 10)	Full	-	40	80	ns
Receiver Skew $t_{PLH} - t_{PHL}$	t_{SKD}	(Figure 10)	Full	-	3	9	ns
Receiver Enable to Output Low	t_{ZL}	$R_L = 1k\Omega, C_L = 15pF, SW = V_{CC}$ (Figure 11), (Notes 13, 19)	Full	-	-	80	ns
Receiver Enable to Output High	t_{ZH}	$R_L = 1k\Omega, C_L = 15pF, SW = GND$ (Figure 11), (Notes 13, 19)	Full	-	-	80	ns
Receiver Disable from Output Low	t_{LZ}	$R_L = 1k\Omega, C_L = 15pF, SW = V_{CC}$ (Figure 11), (Note 19)	Full	-	-	80	ns

Electrical Specifications Test Conditions: $V_{CC} = 3V$ to $3.6V$ and $4.5V$ to $5.5V$, unless otherwise specified. Typicals are at the worst case of $V_{CC} = 5V$ or $V_{CC} = 3.3V$, $T_A = +25^\circ C$ (Note 9). **Boldface limits apply across the operating temperature range, $-40^\circ C$ to $+85^\circ C$.** (Continued)

PARAMETER	SYMBOL	TEST CONDITIONS	TEMP (°C)	MIN (Note 17)	TYP	MAX (Note 17)	UNIT
Receiver Disable from Output High	t_{HZ}	$R_L = 1k\Omega$, $C_L = 15pF$, SW = GND (Figure 11), (Note 19)	Full	-	-	80	ns
Time to Shutdown	t_{SHDN}	(Notes 14, 19)	Full	60	160	600	ns
Receiver Enable from Shutdown to Output High	$t_{ZH(SHDN)}$	$R_L = 1k\Omega$, $C_L = 15pF$, SW = GND (Figure 11), (Notes 14, 16, 19)	Full	-	-	2500	ns
Receiver Enable from Shutdown to Output Low	$t_{ZL(SHDN)}$	$R_L = 1k\Omega$, $C_L = 15pF$, SW = V_{CC} (Figure 11), (Notes 14, 16, 19)	Full	-	-	2500	ns

NOTES:

9. All currents into device pins are positive; all currents out of device pins are negative. All voltages are referenced to device ground unless otherwise specified.
10. Supply current specification is valid for loaded drivers when DE = 0V.
11. Applies to peak current. See "Typical Performance Curves" beginning on page 13 for more information.
12. Keep $\overline{RE} = 0$ to prevent the device from entering shutdown (does not apply to the ISL32457E and ISL32459E).
13. The \overline{RE} signal high time must be short enough (typically <100ns) to prevent the device from entering shutdown.
14. Transceivers are put into shutdown by bringing \overline{RE} high and DE low. If the inputs are in this state for less than 60ns, the parts are ensured not to enter shutdown. If the inputs are in this state for at least 600ns, the parts are ensured to have entered shutdown. See "Low Power Shutdown Mode" on page 19
15. Keep $\overline{RE} = V_{CC}$, and set the DE signal low time >600ns to ensure that the device enters shutdown.
16. Set the \overline{RE} signal high time >600ns to ensure that the device enters shutdown.
17. Compliance to data sheet limits is assured by one or more methods: production test, characterization and/or design.
18. See "Caution" statement following "Absolute Maximum Ratings" on page 7.
19. Does not apply to the ISL32457E and ISL32459E. These transceivers have no Rx enable function, and thus no shutdown function.

Test Circuits and Waveforms

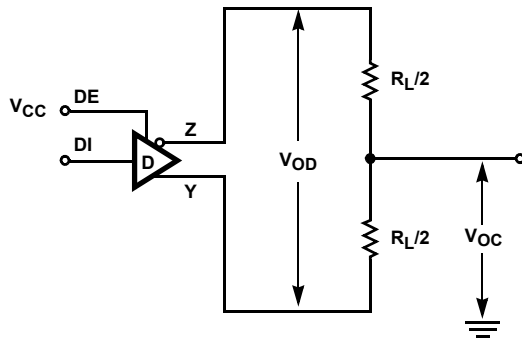

FIGURE 6A. V_{OD} AND V_{OC}

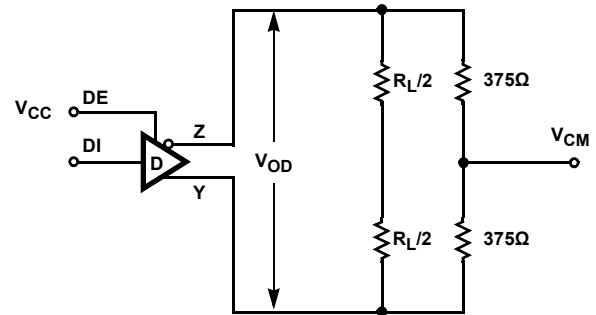

FIGURE 6B. V_{OD} WITH COMMON-MODE LOAD

FIGURE 6. DC DRIVER TEST CIRCUITS

Test Circuits and Waveforms (Continued)

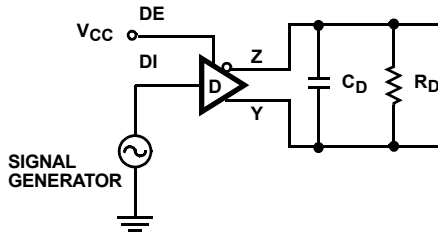

FIGURE 7A. TEST CIRCUIT

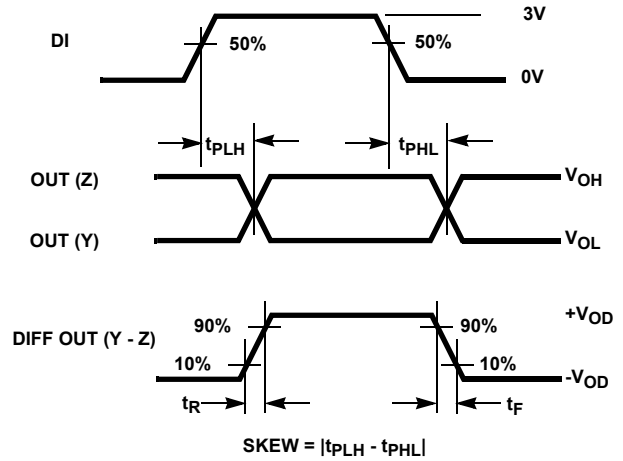

FIGURE 7B. MEASUREMENT POINTS

FIGURE 7. DRIVER PROPAGATION DELAY AND DIFFERENTIAL TRANSITION TIMES

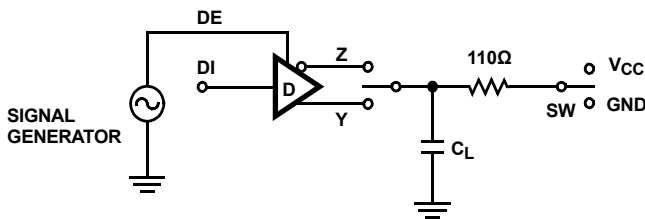

FIGURE 8A. TEST CIRCUIT

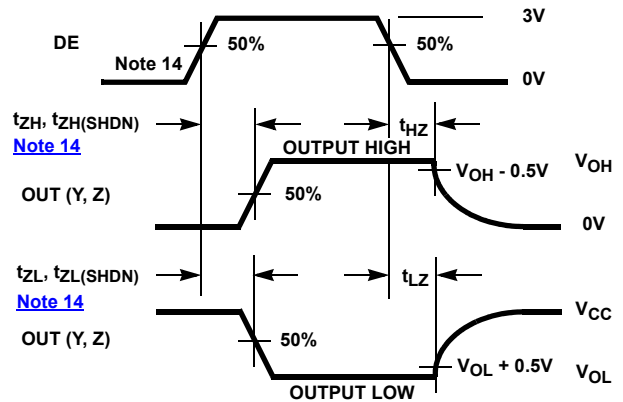

FIGURE 8B. MEASUREMENT POINTS

FIGURE 8. DRIVER ENABLE AND DISABLE TIMES

PARAMETER	OUTPUT	\overline{RE}	DI	SW	C_L (pF)
t_{HZ}	Y/Z	X	1/0	GND	50
t_{LZ}	Y/Z	X	0/1	V_{CC}	50
t_{ZH}	Y/Z	0 (Note 12)	1/0	GND	100
t_{ZL}	Y/Z	0 (Note 12)	0/1	V_{CC}	100
$t_{ZH(SHDN)}$	Y/Z	1 (Note 15)	1/0	GND	100
$t_{ZL(SHDN)}$	Y/Z	1 (Note 15)	0/1	V_{CC}	100

FIGURE 9A. TEST CIRCUIT

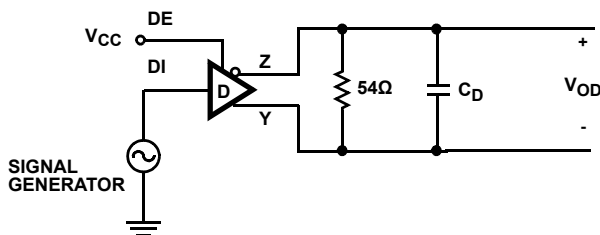

FIGURE 9A. TEST CIRCUIT

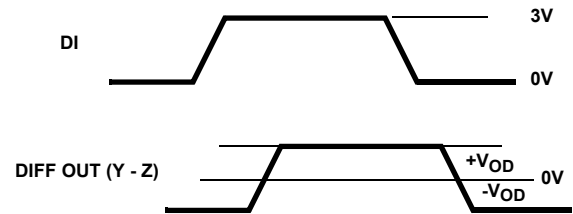

FIGURE 9B. MEASUREMENT POINTS

FIGURE 9. DRIVER DATA RATE

Test Circuits and Waveforms (Continued)

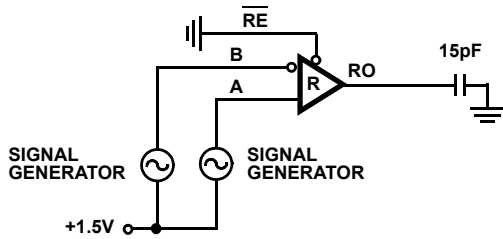

FIGURE 10A. TEST CIRCUIT

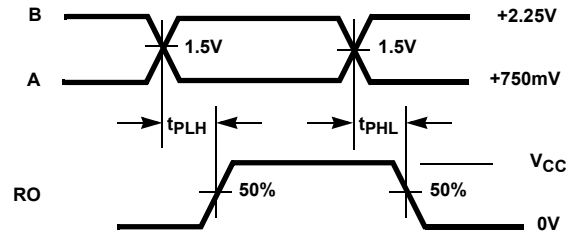
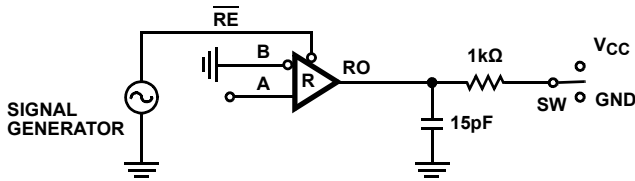

FIGURE 10B. MEASUREMENT POINTS

FIGURE 10. RECEIVER PROPAGATION DELAY AND DATA RATE



PARAMETER	DE	A	SW
t_{HZ}	0	+1.5V	GND
t_{LZ}	0	-1.5V	V_{CC}
t_{ZH} (Note 13)	0	+1.5V	GND
t_{ZL} (Note 13)	0	-1.5V	V_{CC}
$t_{ZH(SHDN)}$ (Note 16)	0	+1.5V	GND
$t_{ZL(SHDN)}$ (Note 16)	0	-1.5V	V_{CC}

FIGURE 11A. TEST CIRCUIT

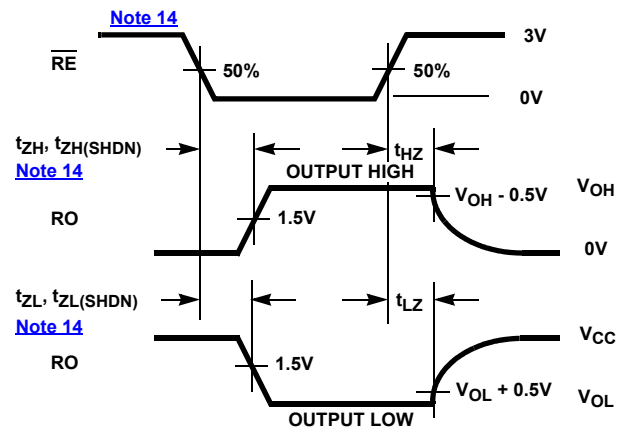

FIGURE 11B. MEASUREMENT POINTS

FIGURE 11. RECEIVER ENABLE AND DISABLE TIMES

Typical Performance Curves

$T_A = +25^\circ\text{C}$; unless otherwise specified.

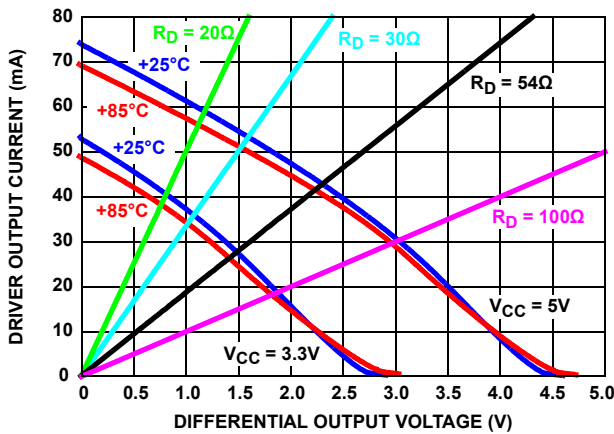

FIGURE 12. DRIVER OUTPUT CURRENT vs DIFFERENTIAL OUTPUT VOLTAGE

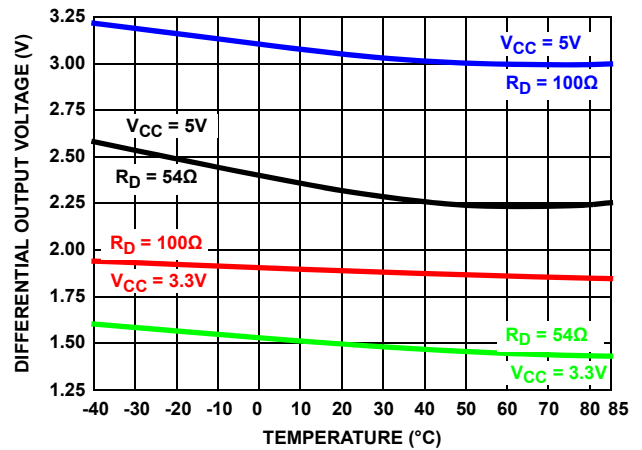

FIGURE 13. DRIVER DIFFERENTIAL OUTPUT VOLTAGE vs TEMPERATURE

Typical Performance Curves

$T_A = +25^\circ\text{C}$; unless otherwise specified. (Continued)

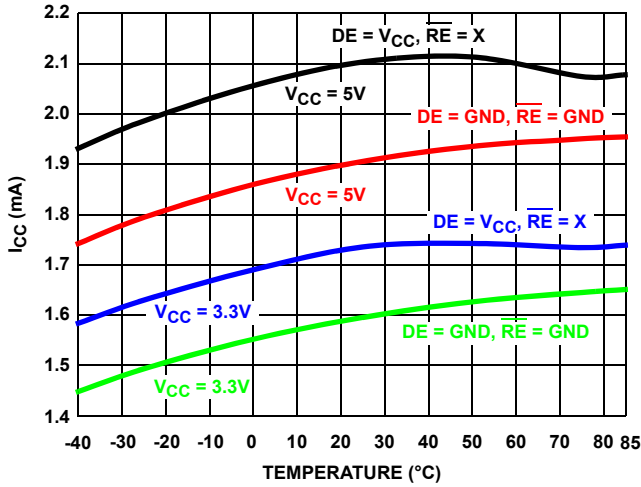

FIGURE 14. SUPPLY CURRENT vs TEMPERATURE

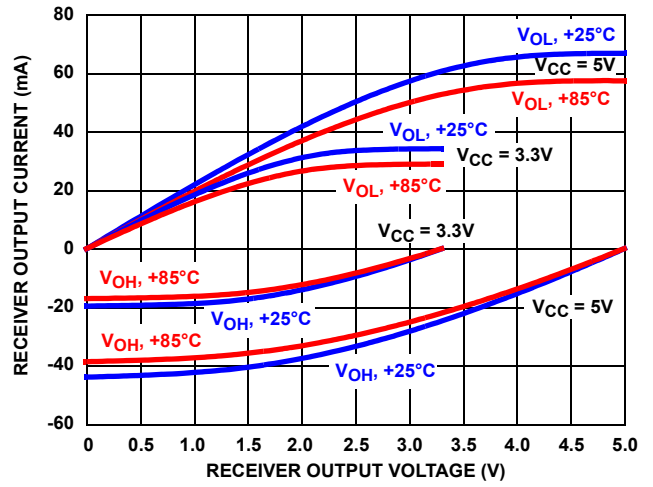

FIGURE 15. RECEIVER OUTPUT CURRENT vs RECEIVER OUTPUT VOLTAGE

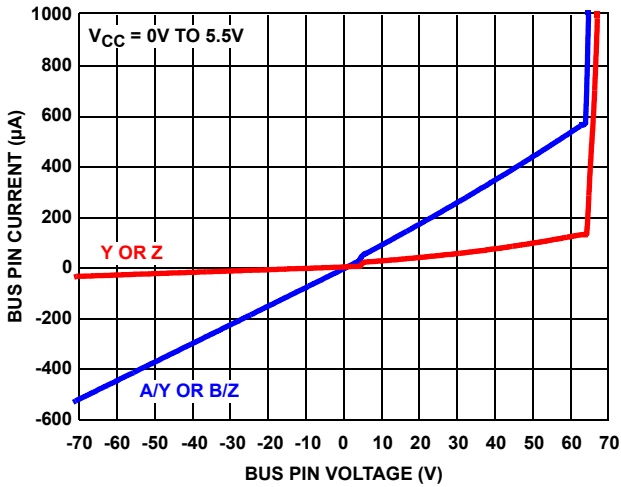

FIGURE 16. BUS PIN CURRENT vs BUS PIN VOLTAGE

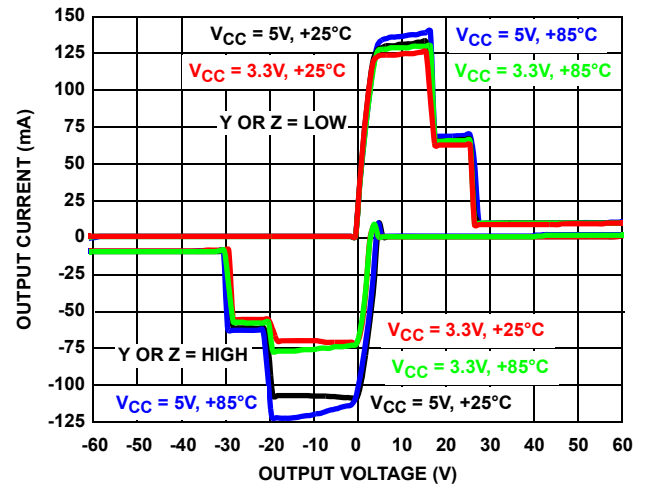

FIGURE 17. DRIVER OUTPUT CURRENT vs SHORT-CIRCUIT VOLTAGE

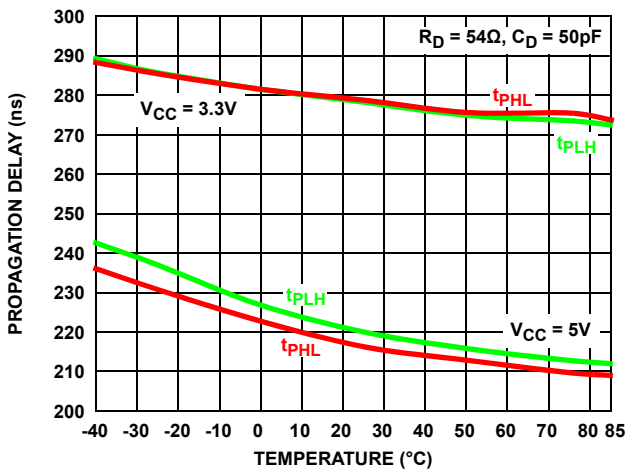

FIGURE 18. DRIVER DIFFERENTIAL PROPAGATION DELAY vs TEMPERATURE (ISL32450E, ISL32452E, ISL32457E)

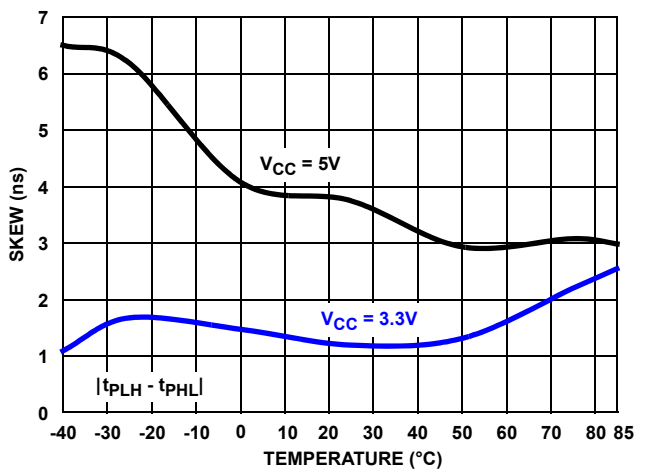

FIGURE 19. DRIVER DIFFERENTIAL SKEW vs TEMPERATURE (ISL32450E, ISL32452E, ISL32457E)

Typical Performance Curves $T_A = +25^\circ\text{C}$; unless otherwise specified. (Continued)

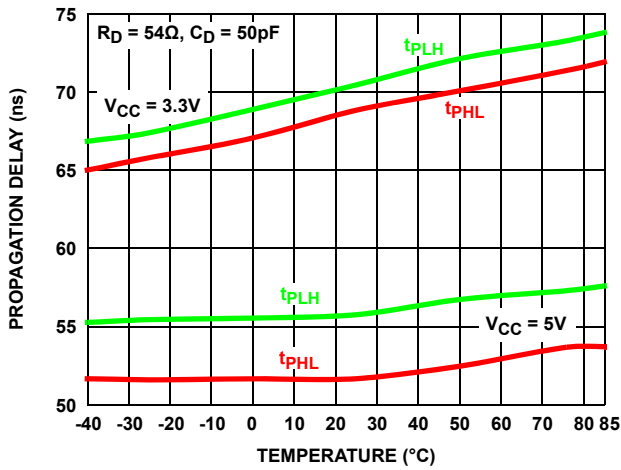

FIGURE 20. DRIVER DIFFERENTIAL PROPAGATION DELAY vs TEMPERATURE (ISL32453E, ISL32455E)

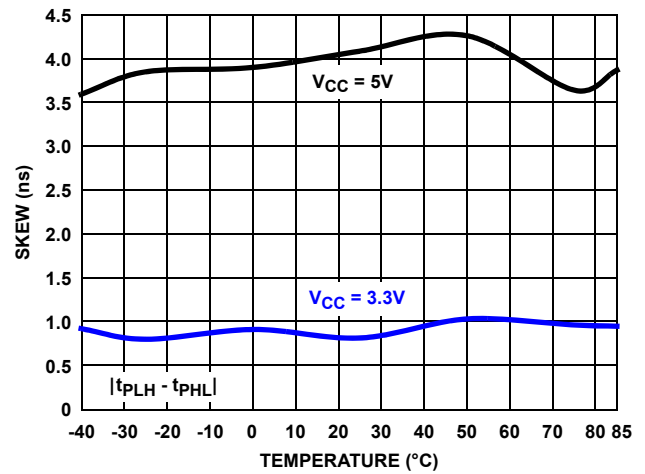

FIGURE 21. DRIVER DIFFERENTIAL SKEW vs TEMPERATURE (ISL32453E, ISL32455E)

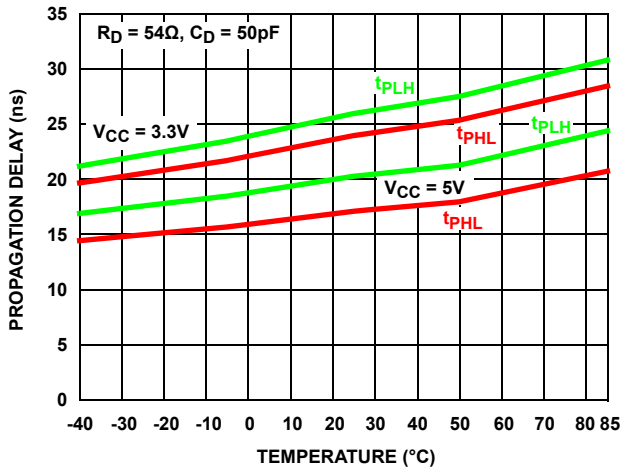

FIGURE 22. DRIVER DIFFERENTIAL PROPAGATION DELAY vs TEMPERATURE (ISL32458E, ISL32459E)

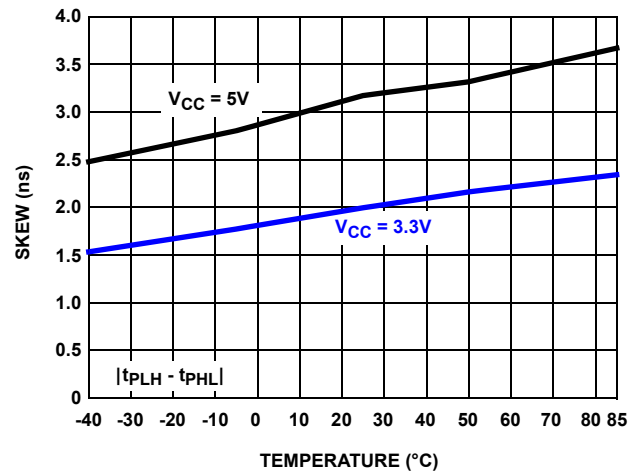

FIGURE 23. DRIVER DIFFERENTIAL SKEW vs TEMPERATURE (ISL32458E, ISL32459E)

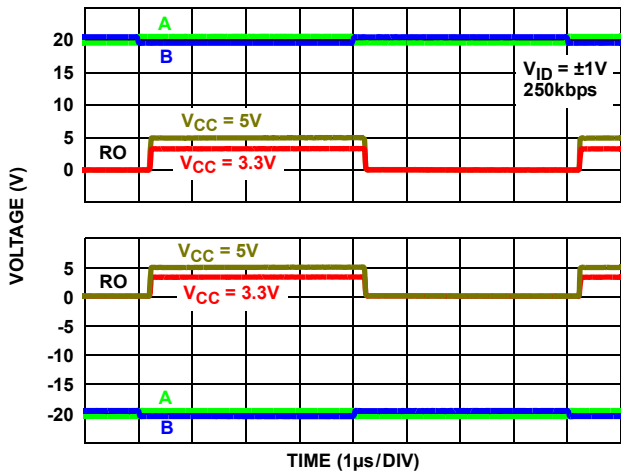

FIGURE 24. $\pm 20\text{V}$ RECEIVER PERFORMANCE (ISL32450E, ISL32452E, ISL32457E)

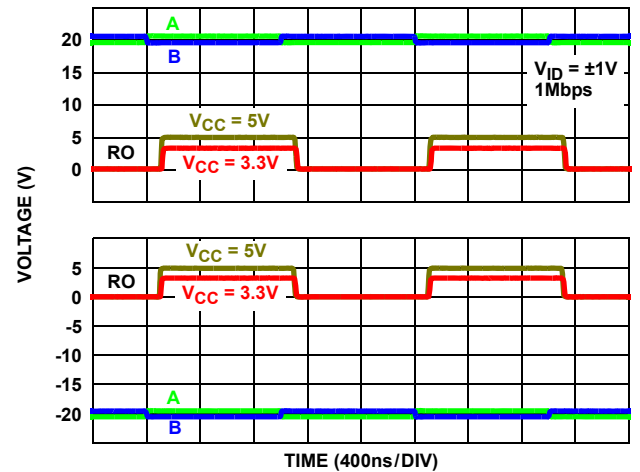

FIGURE 25. $\pm 20\text{V}$ RECEIVER PERFORMANCE (ISL32453E, ISL32455E)

Typical Performance Curves $T_A = +25^\circ\text{C}$; unless otherwise specified. (Continued)

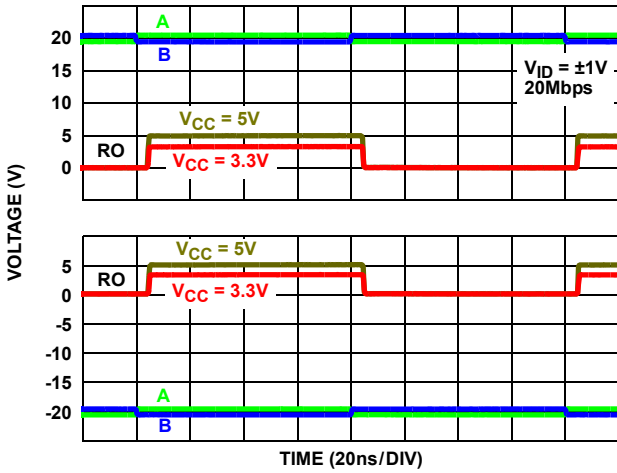

FIGURE 26. $\pm 20V$ RECEIVER PERFORMANCE (ISL32458E, ISL32459E)

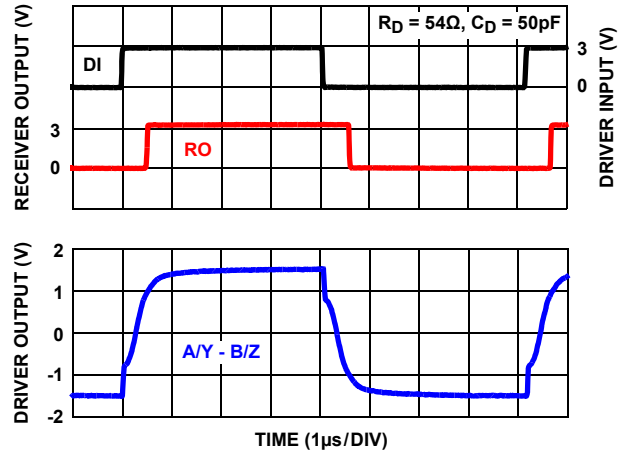

FIGURE 27. $V_{CC} = 3.3V$, DRIVER AND RECEIVER WAVEFORMS (ISL32450E, ISL32452E, ISL32457E)

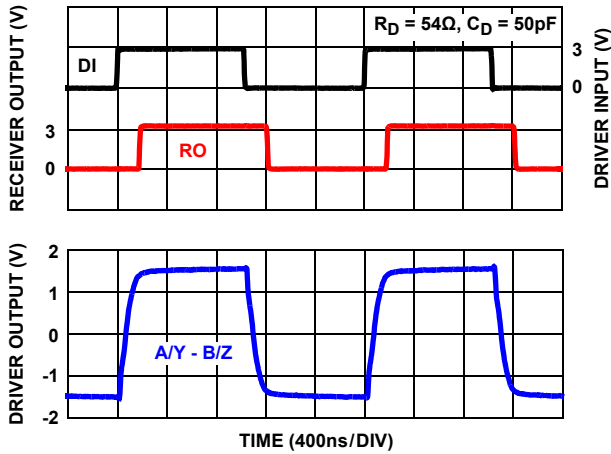

FIGURE 28. $V_{CC} = 3.3V$, DRIVER AND RECEIVER WAVEFORMS (ISL32453E, ISL32455E)

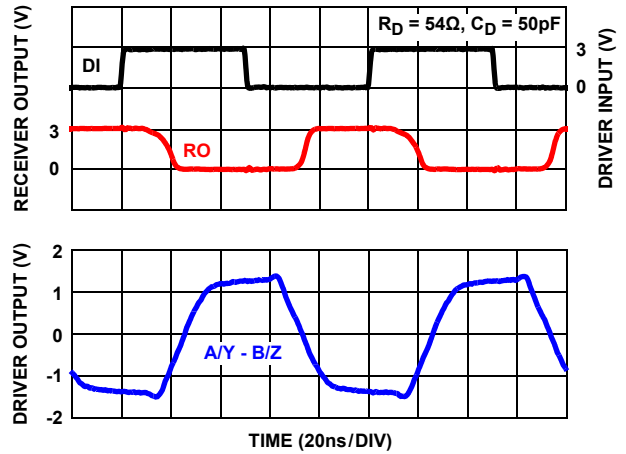

FIGURE 29. $V_{CC} = 3.3V$, DRIVER AND RECEIVER WAVEFORMS (ISL32458E, ISL32459E)

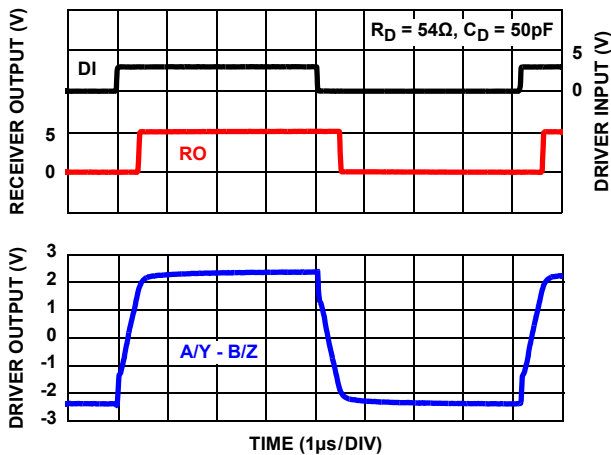

FIGURE 30. $V_{CC} = 5V$, DRIVER AND RECEIVER WAVEFORMS (ISL32450E, ISL32452E, ISL32457E)

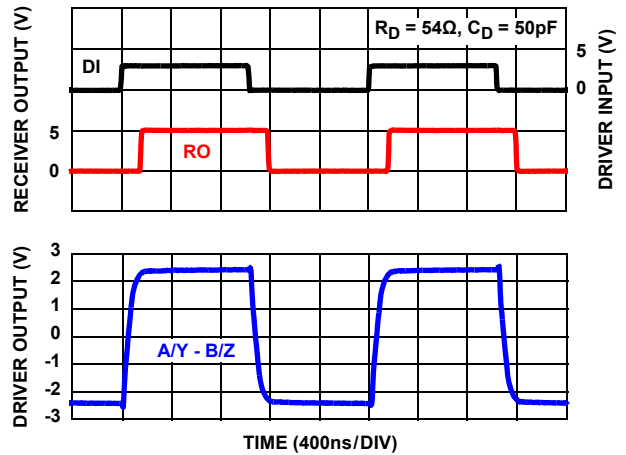

FIGURE 31. $V_{CC} = 5V$, DRIVER AND RECEIVER WAVEFORMS (ISL32453E, ISL32455E)

Typical Performance Curves

$T_A = +25^\circ\text{C}$; unless otherwise specified. (Continued)

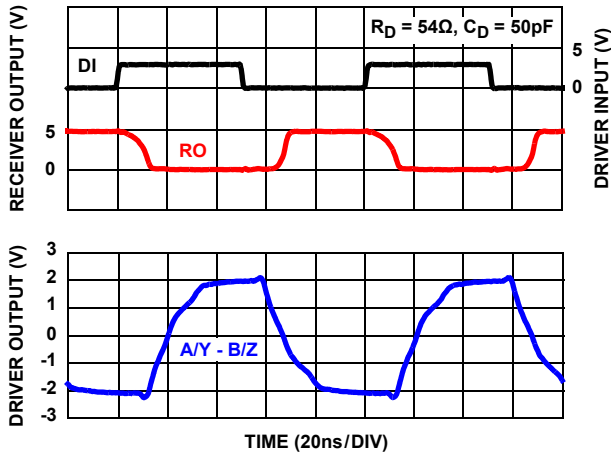

FIGURE 32. $V_{CC} = 5\text{V}$, DRIVER AND RECEIVER WAVEFORMS (ISL32458E, ISL32459E)

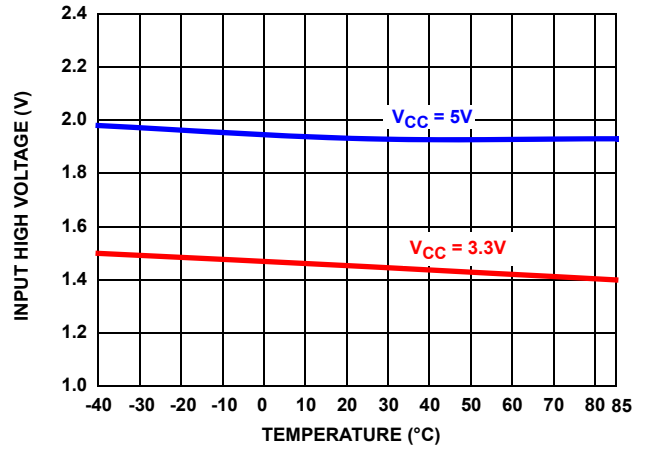

FIGURE 33. LOGIC INPUT HIGH VOLTAGE vs TEMPERATURE

Application Information

RS-485 and RS-422 are differential (balanced) data transmission standards used for long haul or noisy environments. RS-422 is a subset of RS-485, so RS-485 transceivers are also RS-422 compliant. RS-422 is a point-to-multipoint (multidrop) standard that allows only one driver and up to 10 receivers (assuming one unit load devices) on each bus. RS-485 is a true multipoint standard that allows up to 32 one unit load devices (any combination of drivers and receivers) on each bus. To allow for multipoint operation, the RS-485 specification requires that drivers must handle bus contention without sustaining any damage.

An important advantage of RS-485 is the extended Common-Mode Range (CMR), which specifies that the driver outputs and receiver inputs withstand signals that range from +12V to -7V. RS-422 and RS-485 are intended for runs as long as 4000ft, so the wide CMR is necessary to handle ground potential differences and voltages induced in the cable by external fields.

The ISL3245xE are a family of ruggedized RS-485 transceivers that improve on the RS-485 basic requirements and increases system reliability. The CMR increases to $\pm 20V$ that the RS-485 bus pins (receiver inputs and driver outputs) include fault protection against voltages and transients up to $\pm 60V$. Additionally, the $\pm 15kV$ to $\pm 16.5kV$ built-in ESD protection complements the fault protection.

Receiver (Rx) Features

These devices use a differential input receiver for maximum noise immunity and common-mode rejection. Input sensitivity is better than $\pm 200mV$ (3.3V operation), as required by the RS-422 and RS-485 specifications.

The receiver input (load) current surpasses the RS-422 specification of 3mA and is four times lower than the RS-485 Unit Load (UL) requirement of 1mA maximum. Therefore, these products are known as one-quarter UL transceivers, and there can be up to 128 of these devices on a network while still complying with the RS-485 loading specification.

The receiver (Rx) functions, with common-mode voltages as great as $\pm 20V$, make them ideal for industrial or long networks where induced voltages are a realistic concern.

All the receivers include a full fail-safe function that ensures a high level receiver output if the receiver inputs are unconnected (floating), shorted together, or connected to a terminated bus with all the transmitters disabled (an idle bus).

Receivers easily meet the data rates supported by the corresponding driver, and most receiver outputs are tri-statable using the active low RE input.

The Rx in the 250kbps (ISL32450E, ISL32452E, and ISL32457E) and 1Mbps (ISL32453E and ISL32455E) versions include noise filtering circuitry to reject high frequency signals. The ISL32453E and ISL32455E typically reject pulses narrower than 50ns (equivalent to 20Mbps), while the ISL32450E, ISL32452E, and ISL32457E Rx reject pulses below 150ns (6.7Mbps). The ISL32450E, ISL32452E, and ISL32457E have no Rx noise filtering.

Driver (Tx) Features

The RS-485/RS-422 driver is a differential output device that delivers at least 1.7V across a 54Ω load (RS-485), and at least 2V across a 100Ω load (RS-422) with $V_{CC} \geq 4.5V$. The drivers feature low propagation delay skew to maximize bit width and to minimize EMI. All drivers are tri-statable through the active high DE input.

The 250kbps and 1Mbps driver outputs are slew rate limited to minimize EMI and reflections in unterminated or improperly terminated networks. The ISL32458E and ISL32459E driver outputs are not limited, so faster output transition times allow data rates of at least 20Mbps.

High Overvoltage (Fault) Protection Increases Ruggedness

Note: The available smaller pitch package (MSOP) may not meet the Creepage and Clearance (C&C) requirements for $\pm 60V$ levels. Determine C&C requirements before selecting a package type.

The $\pm 60V$ fault protection (referenced to the IC GND) on the RS-485 pins makes these transceivers some of the most rugged on the market. This level of protection makes the ISL3245xE family ideal for applications where power (such as 24V and 48V supplies) must be routed in the conduit with the data lines and for outdoor applications where large transients are likely to occur. When power is routed with the data lines, even a momentary short between the supply and data lines destroys an unprotected device. The $\pm 60V$ fault levels of this family are at least four times higher than the levels specified for standard RS-485 ICs. The ISL3245xE's protection is active whether the Tx is enabled or disabled, and even if the IC is powered down or VCC and Ground are floating.

If transients or voltages (including overshoots and ringing) greater than $\pm 60V$ are possible, additional external protection is required. Use a protection device with the lowest clamping voltage acceptable for the application. Note, TVS type devices typically clamp 5V to 10V above the designated stand-off voltage (for example, a "54V TVS" clamps between 60V and 66V).

Wide Common-Mode Voltage (CMV) Tolerance Improves Operating Range

RS-485 networks operating in industrial complexes or over long distances are susceptible to large CMV variations. Either of these operating environments can suffer from large node-to-node ground potential differences or CMV pickup from external electromagnetic sources, and devices with only the minimum required +12V to -7V CMR can malfunction. The ISL3245xE's extended $\pm 20V$ CMR allows for operation in environments that would overwhelm lesser transceivers. Additionally, the Rx does not phase invert (erroneously change state) even with CMVs of $\pm 25V$ or differential voltages as large as 40V.

Cable Invert (Polarity Reversal) Function

Large node count RS-485 networks are commonly wired backwards during installation. When this happens, the node is unable to communicate over the network. When a technician finds the miswired node, they must then rewire the connector, which is time consuming.

The ISL32457E and ISL32459E simplify this task by including a cable invert pin (INV) that allows the technician to invert the polarity of the Rx input and the Tx output pins simply by moving a jumper to change the state of the invert pin. When the invert pin is low, the IC operates like any standard RS-485 transceiver, and the bus pins have their normal polarity definition of A and Y as noninverting and B and Z as inverting. With the invert pin high, the corresponding bus pins reverse their polarity, so B and Z become noninverting, and A and Y become inverting.

This unique cable invert function is superior to that found on competing devices, because the Rx full fail-safe function is maintained, even when the Rx polarity is reversed. Competitor devices implement the Rx invert function simply by inverting the Rx output. This means that with the Rx inputs floating or shorted together, the Rx appropriately delivers a logic 1 in normal polarity, but outputs a logic low when the IC is operated in the inverted mode. The innovative Renesas Rx design ensures that the Rx output remains high with the Rx inputs floating or shorted together ($V_{ID} = 0V$), regardless of the state of the invert pin.

Data Rate, Cables, and Terminations

RS-485/RS-422 are intended for network lengths up to 4000ft, but the maximum system data rate decreases as the transmission length increases. High speed versions operating at 20Mbps can be used at lengths up to 150ft (46m), but the distance can be increased to 328ft (100m) by operating them at 5Mbps. The ISL32453E and ISL32455E can operate at the full data rate of 1Mbps with lengths up to 800ft (244m). Jitter is the limiting parameter at faster data rates and may limit the network to shorter lengths, so employing encoded data streams (such as Manchester coded or Return-to-Zero) may allow increased transmission distances. The ISL32450E, ISL32452E, and ISL32457E can operate at 115kbps or less at the full 4000ft (1220m) distance, or at 250kbps for lengths up to 3000ft (915m). DC cable attenuation is the limiting parameter, so using better quality cables (such as 22 AWG) may allow increased transmission distance.

Use twisted pair cables for RS-485/RS-422 networks. Twisted pair cables tend to pick up noise and other electromagnetically induced voltages as common-mode signals that are effectively rejected by the differential receivers in these ICs.

Note: Proper termination is imperative to minimize reflections when using the 20Mbps ISL32458E and ISL32459E devices. Short networks using the 250kbps ISL32450E, ISL32452E, and ISL32457E versions do not need to be terminated; however, terminations are recommended unless power dissipation is an overriding concern.

In point-to-point or point-to-multireceiver networks (single driver on bus like RS-422), terminate the main cable in its characteristic impedance (typically 120 Ω) at the end farthest from the driver. In multireceiver applications, keep stubs

connecting receivers to the main cable as short as possible. Multipoint (multidriver) systems require that the main cable is terminated in its characteristic impedance at both ends. Keep stubs connecting a transceiver to the main cable as short as possible.

Built-In Driver Overload Protection

The RS-485 specification requires that drivers survive worst-case bus contentions undamaged. These transceivers meet this requirement through driver output short-circuit current limits and on-chip thermal shutdown circuitry.

The driver output stages incorporate a double foldback short-circuit current limiting scheme that ensures that the output current never exceeds the RS-485 specification, even at the common-mode and fault condition voltage range extremes. The first foldback current level ($\approx 83mA$) is set to ensure that the driver never folds back when driving loads with common-mode voltages up to $\pm 20V$. The very low second foldback current setting ($\approx 13mA$) minimizes power dissipation if the Tx is enabled when a fault occurs.

In the event of a major short-circuit condition, the ISL3245xE's thermal shutdown feature disables the drivers whenever the die temperature becomes excessive. Thermal shutdown eliminates the power dissipation allowing the die to cool. The drivers automatically re-enable after the die temperature drops about 15°C. If the contention persists, the thermal shutdown/re-enable cycle repeats until the fault is cleared. The receivers stay operational during thermal shutdown.

Low Power Shutdown Mode

These BiCMOS transceivers all use a fraction of the power required by competitive devices, but they (excluding ISL32457E and ISL32459E) also include a shutdown feature that reduces the already low quiescent I_{CC} to a 10 μA trickle. These devices enter shutdown whenever the receiver and driver are simultaneously disabled ($\overline{RE} = V_{CC}$ and $DE = GND$) for a period of at least 600ns. Disabling both the driver and the receiver for less than 60ns ensures that the transceiver does not enter shutdown.

Note: The receiver and driver enable times increase when the transceiver enables from shutdown. See [Notes 12](#) through [16](#) on [page 11](#) for more information.

Die Characteristics

SUBSTRATE POTENTIAL (POWERED UP):

GND

PROCESS:

Si Gate BiCMOS

Revision History The revision history provided is for informational purposes only and is believed to be accurate, but not warranted. Please visit our website to make sure you have the latest revision.

DATE	REVISION	CHANGE
Feb 14, 2019	FN7921.3	Updated links throughout document. Updated ordering information table by adding all tape and reel information and updating notes. Updated last sentence in second paragraph in "High Overvoltage (Fault) Protection Increases Ruggedness" on page 18 Removed About Intersil section. Updated disclaimer.
August 31, 2017	FN7921.2	Updated the receiving truth table on page 3.
December 1, 2015	FN7921.1	Added 20Mbps versions (ISL32458E and ISL32459E) to datasheet. Replaced Products section with About Intersil verbiage. Updated Package Outline Drawing M10.118 to the latest version. Changes are as follows: -Updated to new POD template. Added land pattern.
February 20, 2012	FN7921.0	Initial release

Package Outline Drawings

For the most recent package outline drawing, see [M8.118](#).

M8.118

8 LEAD MINI SMALL OUTLINE PLASTIC PACKAGE

Rev 4, 7/11

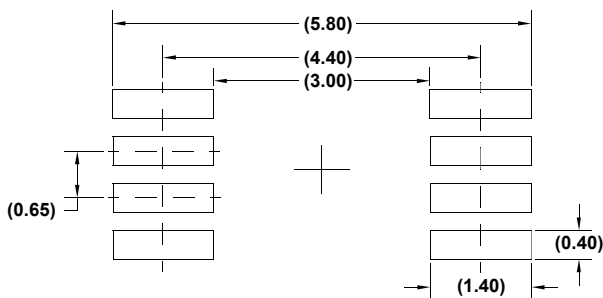
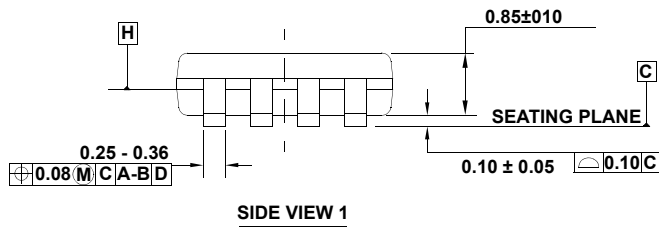
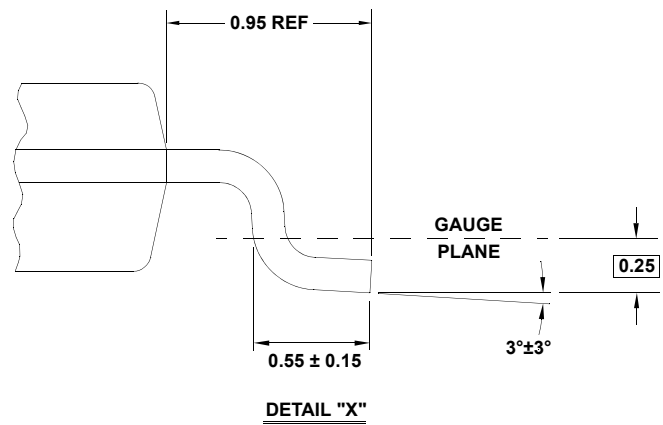
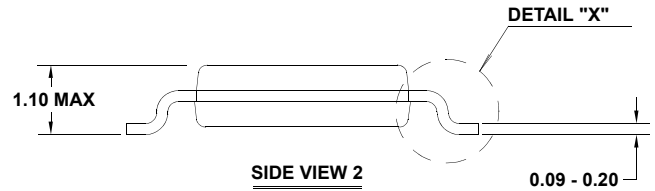

NOTES:

1. Dimensions are in millimeters.
2. Dimensioning and tolerancing conform to JEDEC MO-187-AA and AMSEY14.5m-1994.
3. Plastic or metal protrusions of 0.15mm max per side are not included.
4. Plastic interlead protrusions of 0.15mm max per side are not included.
5. Dimensions are measured at Datum Plane "H".
6. Dimensions in () are for reference only.

M8.15

8 LEAD NARROW BODY SMALL OUTLINE PLASTIC PACKAGE

Rev 4, 1/12

For the most recent package outline drawing, see [M8.15](#).

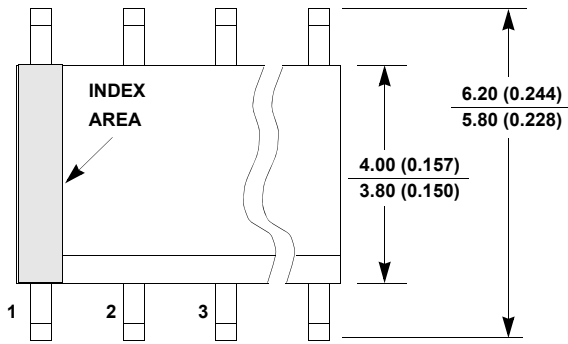

TOP VIEW

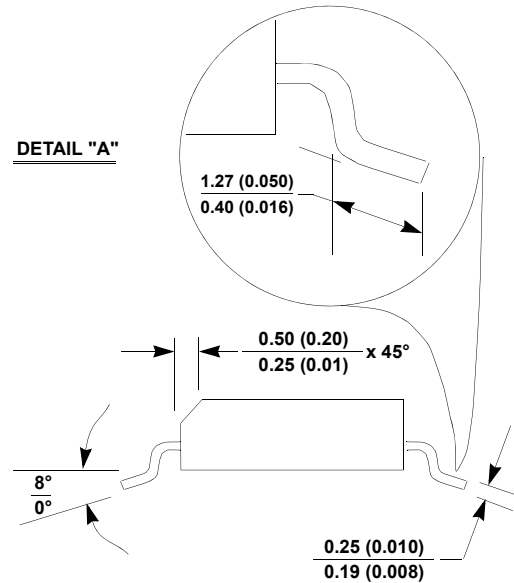

SIDE VIEW "B"

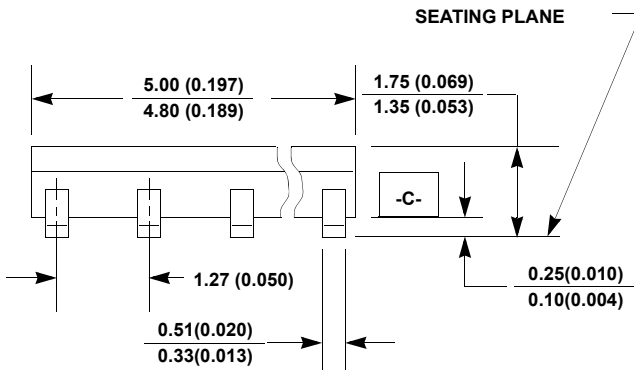

SIDE VIEW "A"

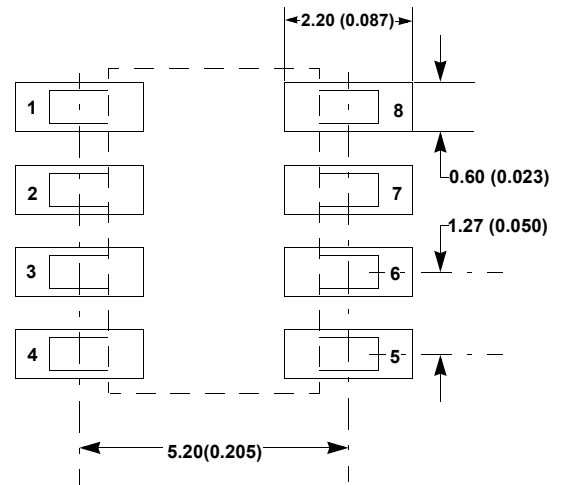

TYPICAL RECOMMENDED LAND PATTERN

NOTES:

20. Dimensioning and tolerancing per ANSI Y14.5M-1994.
21. Package length does not include mold flash, protrusions or gate burrs. Mold flash, protrusion and gate burrs shall not exceed 0.15mm (0.006 inch) per side.
22. Package width does not include interlead flash or protrusions. Interlead flash and protrusions shall not exceed 0.25mm (0.010 inch) per side.
23. The chamfer on the body is optional. If it is not present, a visual index feature must be located within the crosshatched area.
24. Terminal numbers are shown for reference only.
25. The lead width as measured 0.36mm (0.014 inch) or greater above the seating plane, shall not exceed a maximum value of 0.61mm (0.024 inch).
26. Controlling dimension: MILLIMETER. Converted inch dimensions are not necessarily exact.
27. This outline conforms to JEDEC publication MS-012-AA ISSUE C.

M10.118

10 LEAD MINI SMALL OUTLINE PLASTIC PACKAGE

Rev 1, 4/12

For the most recent package outline drawing, see [M10.118](#).

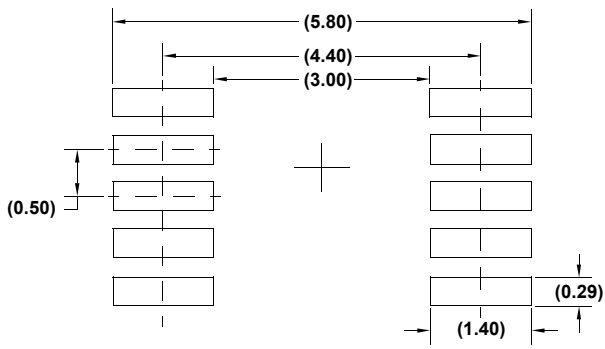
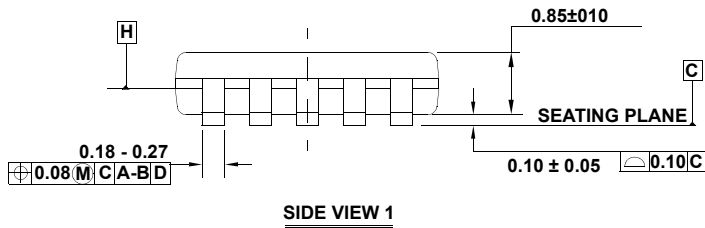
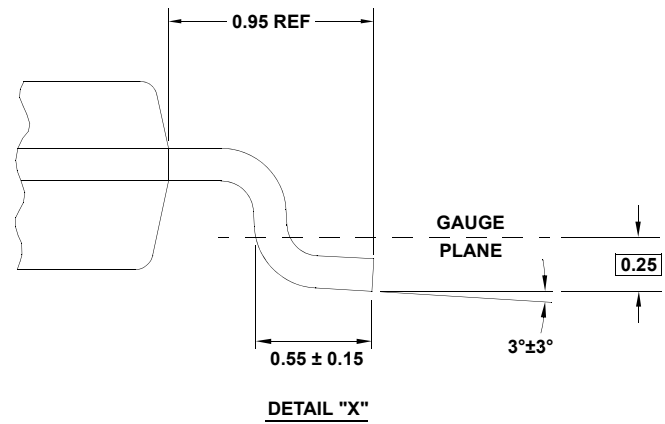
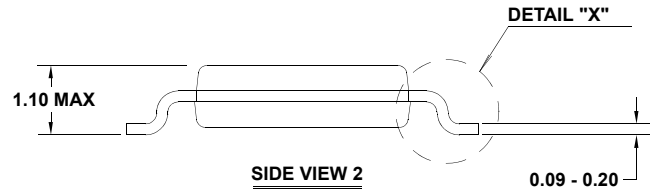
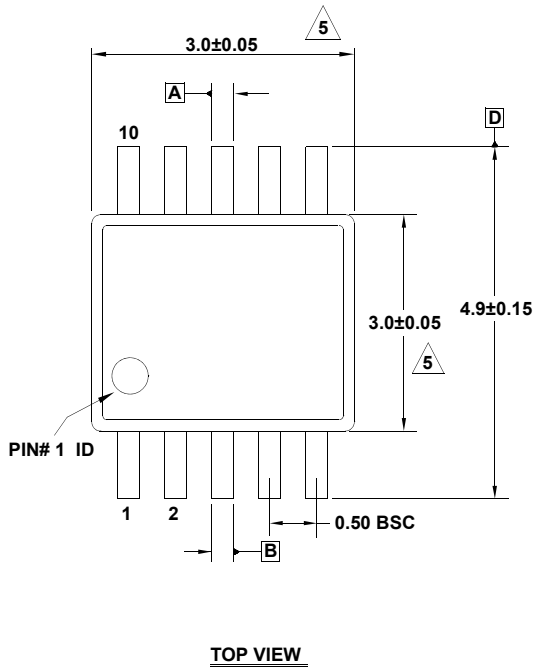

NOTES:

1. Dimensions are in millimeters.
2. Dimensioning and tolerancing conform to JEDEC MO-187-BA and AMSEY14.5m-1994.
3. Plastic or metal protrusions of 0.15mm max per side are not included.
4. Plastic interlead protrusions of 0.15mm max per side are not included.

5. Dimensions are measured at Datum Plane "H".

6. Dimensions in () are for reference only.

M14.15

14 LEAD NARROW BODY SMALL OUTLINE PLASTIC PACKAGE

Rev 1, 10/09

For the most recent package outline drawing, see [M14.15](#).

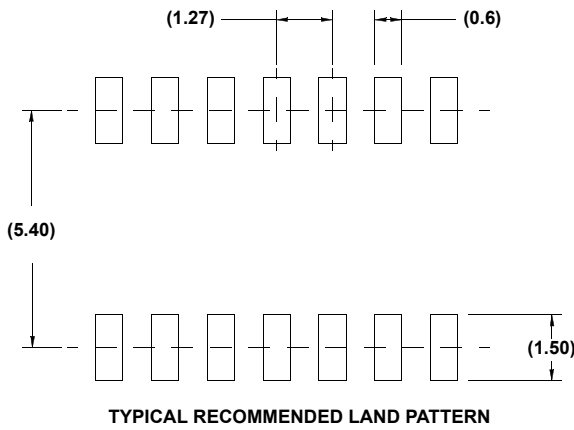
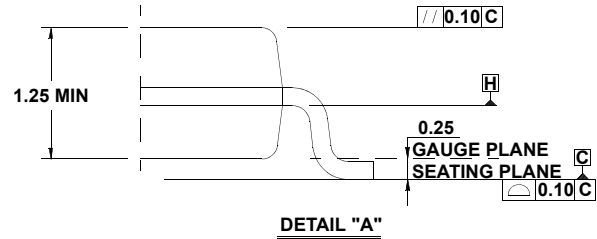
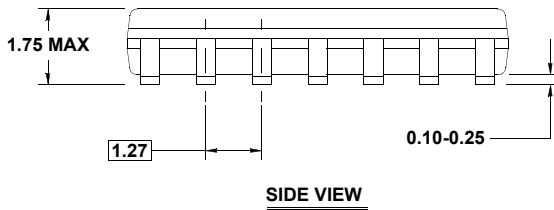
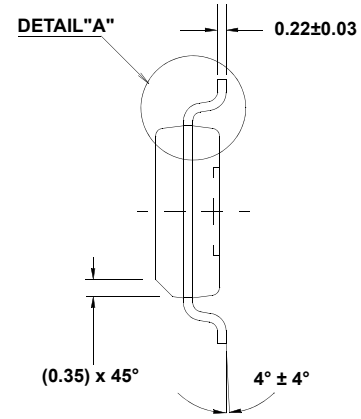
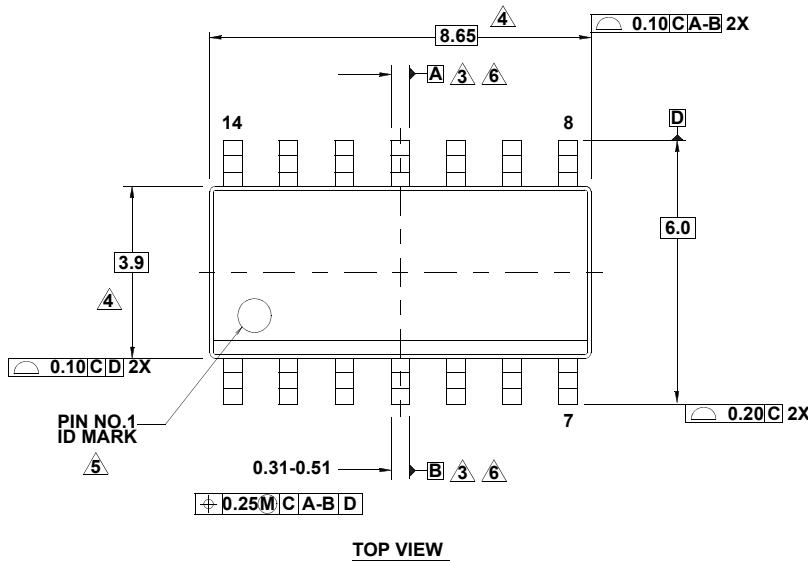

NOTES:

1. Dimensions are in millimeters.
Dimensions in () for Reference Only.
2. Dimensioning and tolerancing conform to AMSEY14.5m-1994.
3. Datums A and B to be determined at Datum H.
4. Dimension does not include interlead flash or protrusions.
Interlead flash or protrusions shall not exceed 0.25mm per side.
5. The pin #1 identifier may be either a mold or mark feature.
6. Does not include dambar protrusion. Allowable dambar protrusion shall be 0.10mm total in excess of lead width at maximum condition.
7. Reference to JEDEC MS-012-AB.

Notice

1. Descriptions of circuits, software and other related information in this document are provided only to illustrate the operation of semiconductor products and application examples. You are fully responsible for the incorporation or any other use of the circuits, software, and information in the design of your product or system. Renesas Electronics disclaims any and all liability for any losses and damages incurred by you or third parties arising from the use of these circuits, software, or information.
 2. Renesas Electronics hereby expressly disclaims any warranties against and liability for infringement or any other claims involving patents, copyrights, or other intellectual property rights of third parties, by or arising from the use of Renesas Electronics products or technical information described in this document, including but not limited to, the product data, drawings, charts, programs, algorithms, and application examples.
 3. No license, express, implied or otherwise, is granted hereby under any patents, copyrights or other intellectual property rights of Renesas Electronics or others.
 4. You shall not alter, modify, copy, or reverse engineer any Renesas Electronics product, whether in whole or in part. Renesas Electronics disclaims any and all liability for any losses or damages incurred by you or third parties arising from such alteration, modification, copying or reverse engineering.
 5. Renesas Electronics products are classified according to the following two quality grades: "Standard" and "High Quality". The intended applications for each Renesas Electronics product depends on the product's quality grade, as indicated below.
 - "Standard": Computers; office equipment; communications equipment; test and measurement equipment; audio and visual equipment; home electronic appliances; machine tools; personal electronic equipment; industrial robots; etc.
 - "High Quality": Transportation equipment (automobiles, trains, ships, etc.); traffic control (traffic lights); large-scale communication equipment; key financial terminal systems; safety control equipment; etc.Unless expressly designated as a high reliability product or a product for harsh environments in a Renesas Electronics data sheet or other Renesas Electronics document, Renesas Electronics products are not intended or authorized for use in products or systems that may pose a direct threat to human life or bodily injury (artificial life support devices or systems; surgical implantations; etc.), or may cause serious property damage (space system; undersea repeaters; nuclear power control systems; aircraft control systems; key plant systems; military equipment; etc.). Renesas Electronics disclaims any and all liability for any damages or losses incurred by you or any third parties arising from the use of any Renesas Electronics product that is inconsistent with any Renesas Electronics data sheet, user's manual or other Renesas Electronics document.
 6. When using Renesas Electronics products, refer to the latest product information (data sheets, user's manuals, application notes, "General Notes for Handling and Using Semiconductor Devices" in the reliability handbook, etc.), and ensure that usage conditions are within the ranges specified by Renesas Electronics with respect to maximum ratings, operating power supply voltage range, heat dissipation characteristics, installation, etc. Renesas Electronics disclaims any and all liability for any malfunctions, failure or accident arising out of the use of Renesas Electronics products outside of such specified ranges.
 7. Although Renesas Electronics endeavors to improve the quality and reliability of Renesas Electronics products, semiconductor products have specific characteristics, such as the occurrence of failure at a certain rate and malfunctions under certain use conditions. Unless designated as a high reliability product or a product for harsh environments in a Renesas Electronics data sheet or other Renesas Electronics document, Renesas Electronics products are not subject to radiation resistance design. You are responsible for implementing safety measures to guard against the possibility of bodily injury, injury or damage caused by fire, and/or danger to the public in the event of a failure or malfunction of Renesas Electronics products, such as safety design for hardware and software, including but not limited to redundancy, fire control and malfunction prevention, appropriate treatment for aging degradation or any other appropriate measures. Because the evaluation of microcomputer software alone is very difficult and impractical, you are responsible for evaluating the safety of the final products or systems manufactured by you.
 8. Please contact a Renesas Electronics sales office for details as to environmental matters such as the environmental compatibility of each Renesas Electronics product. You are responsible for carefully and sufficiently investigating applicable laws and regulations that regulate the inclusion or use of controlled substances, including without limitation, the EU RoHS Directive, and using Renesas Electronics products in compliance with all these applicable laws and regulations. Renesas Electronics disclaims any and all liability for damages or losses occurring as a result of your noncompliance with applicable laws and regulations.
 9. Renesas Electronics products and technologies shall not be used for or incorporated into any products or systems whose manufacture, use, or sale is prohibited under any applicable domestic or foreign laws or regulations. You shall comply with any applicable export control laws and regulations promulgated and administered by the governments of any countries asserting jurisdiction over the parties or transactions.
 10. It is the responsibility of the buyer or distributor of Renesas Electronics products, or any other party who distributes, disposes of, or otherwise sells or transfers the product to a third party, to notify such third party in advance of the contents and conditions set forth in this document.
 11. This document shall not be reprinted, reproduced or duplicated in any form, in whole or in part, without prior written consent of Renesas Electronics.
 12. Please contact a Renesas Electronics sales office if you have any questions regarding the information contained in this document or Renesas Electronics products.
- (Note1) "Renesas Electronics" as used in this document means Renesas Electronics Corporation and also includes its directly or indirectly controlled subsidiaries.
- (Note2) "Renesas Electronics product(s)" means any product developed or manufactured by or for Renesas Electronics.

(Rev.4.0-1 November 2017)

Corporate Headquarters

TOYOSU FORESIA, 3-2-24 Toyosu,
Koto-ku, Tokyo 135-0061, Japan
www.renesas.com

Contact Information

For further information on a product, technology, the most up-to-date version of a document, or your nearest sales office, please visit:
www.renesas.com/contact/

Trademarks

Renesas and the Renesas logo are trademarks of Renesas Electronics Corporation. All trademarks and registered trademarks are the property of their respective owners.