

Renesas Synergy™ Platform

Tuning the Capacitive Touch Solution

Introduction

You will need to perform a Capacitive Touch Tuning process before using the Capacitive Touch Framework for touch detection in the Synergy Software™ Package (SSP). The tuning process uses the Capacitive Touch Sensing Unit (CTSUS) HAL driver provided by the SSP.

This document enables you to effectively use the Capacitive Touch Tuning process in your own design by referencing several sample capacitive touch tuning projects for Renesas Synergy™ Kits. Using this document, you will be able to create a capacitive touch tuning project for your own hardware system, configure it correctly for the target application, and use the attached tuning example code in your tuning project.

The tuning process generates a set of configuration settings for the CTSUS on the Synergy MCU. These configurations include touch detection threshold and hysteresis at an optimized CTSUS hardware configuration to achieve optimal sensitivity for the hardware platform tuned. For details on Capacitive Touch Sensing Unit (CTSUS) and its principles of operation, see the applicable Renesas Synergy™ MCU User's Manual.

Required Resources

To build and run the capacitive touch tuning example, you need:

- Renesas AE-CAP1, DK-S124, SK-S7G2, or PK-S5D9 (only the kit you intend to perform the tuning on).
- Renesas Synergy™ e² studio ISDE v7.5.1 or later, or IAR Embedded Workbench® for Renesas Synergy™ v8.23.3 or later
- Synergy Software Package (SSP) 1.7.0 or later
- Synergy Standalone Configuration (SSC) 7.5.1 and later
- SEGGER J-Link® USB driver
- Two Micro USB cables
- Serial to USB conversion cable
- *Capacitive Touch Workbench for Synergy (CTW for Synergy) First Step Guide*, version 1.5.0033 or later
- Download all the required Renesas software from the Renesas Synergy™ website at renesas.com/synergy/software.

Prerequisites and Intended Audience

This application project assumes you have some experience with the Renesas Synergy™ e² studio ISDE and Synergy Software Package (SSP). Before you perform the procedure in this application note, follow the procedure in the *SSP User's Manual* to build and run the Blinky project. Doing so enables you to become familiar with the e² studio and the SSP, and to ensure that the debug connection to your board functions properly. In addition, this application project assumes you have some knowledge on Capacitive Touch Technology and the *Capacitive Touch Hardware Design and Layout Guide* for Renesas Synergy.

The intended audience is users who want to develop Capacitive Touch applications with CTSUS using Synergy S1/S3/S5/S7 MCU Series.

Contents

1.	Capacitive Touch Tuning Overview	3
1.1	Capacitive Touch Workbench for Renesas Synergy.....	3
1.2	Capacitive Touch Tuning support from SSP	3
1.2.1	SSP CTSU Tuning Driver	3
1.2.2	SSP CTSU HAL Driver	4
1.2.3	USB and UART Communication with CTW for Synergy	5
1.2.4	Operational Notes and Limitations of the Current Capacitive Touch Tuning Solution.....	6
2.	Capacitive Touch Tuning Operating Overview	7
3.	Capacitive Touch Tuning with CTW for Synergy	9
3.1	Example Capacitive Touch Tuning Software Projects	9
3.1.1	Importing the CTSU Tuning Project	9
3.1.2	Configurations of the Capacitive Touch Tuning Project.....	10
3.2	Start the CTW for Synergy	11
3.3	Running the CTSU Tuning Project.....	16
3.3.1	Powering up the AE-CAP1-S1 and AE-CAP1-BWS Board.....	16
3.3.2	Install USB CDC Driver on Windows	17
3.4	Continue and Finish Tuning with CTW for Synergy	18
3.5	Monitoring the CTSU Operation after Tuning.....	23
4.	Using the Tuning Results in Capacitive Touch Applications	23
4.1	Sample Capacitive Touch Applications.....	23
4.2	General Steps to Import the Tuning Result to an Application Project.....	24
5.	Sensor Layout Summary	24
5.1	Capacitive Touch Sensor layout on AE-CAP1	24
5.1.1	AE-CAP1-S1 and AE-CAP1-BWS Touch Sensor Layout.....	24
5.1.2	AE-CAP1-S3 and AE-CAP1-BWS Touch Sensor Layout.....	25
5.1.3	AE-CAP1-S1 and AE-CAP1-SC Touch Sensor Layout	25
5.1.4	AE-CAP1-S3 and AE-CAP1-SC Touch Sensor Layout	25
5.1.5	AE-CAP1-S1 and AE-CAP1-MC	25
5.1.6	AE-CAP1-S3A7 and AE-CAP1-MC.....	26
5.2	Capacitive Touch Sensor Layout on SK-S7G2 (v3.2 and later).....	27
5.3	Capacitive Touch Sensor layout on DK-S124.....	27
5.4	Capacitive Touch Sensor layout on PK-S5D9	27
6.	Creating a Capacitive Touch Tuning Project for a Custom PCB Board	28
7.	References	29
	Revision History	31

1. Capacitive Touch Tuning Overview

Touch pad capacitive values change based on the board layout and environmental conditions. The tuning process optimizes product performance by measuring touch pad capacitive values in the touched and untouched state. The tuning process also helps the capacitive touch system designer optimize touch pad operations.

The capacitive touch tuning process uses several pieces of software together with the hardware system to perform the tuning. To establish a functioning capacitive touch system, three software components are needed:

- The Capacitive Touch Tuning Software Project
- The Capacitive Touch Workbench (CTW) for Synergy
- This Application Software Project

This application project focuses on the capacitive touch tuning operation. You are advised to reference the *Self-Capacitive Touch Software Application Design with S124 and S3A7 Synergy MCUs* and the *Mutual-Capacitive Touch Software Application Design with S124 and S3A7 Synergy MCUs* for additional details on how the application ensures the capacitive touch tuning result.

The following sections introduce the PC side of the Capacitive Touch Tuning Software and the Synergy Tuning Software Projects used with the PC side tools.

1.1 Capacitive Touch Workbench for Renesas Synergy

The Capacitive Touch Workbench for Renesas Synergy (CTW for Synergy) is a GUI that runs on Windows® and communicates with the target touch system via a USB or UART connection.

Note the following about CTW for Synergy:

- The GUI is a modified version of the original Workbench 6 and supports only Synergy products.
- You will perform the tuning processes using the GUI and create a layout of the target board including buttons, sliders and wheels that specify which Capacitive Touch Sensing Unit (CTSUs) channels are used for each widget.
- The application then runs the tuning process and prompts you at appropriate points to touch and release each widget to determine the thresholds.
- You can monitor the CTSU values on the target board using the GUI once tuning is complete.

Visit [renesas.com/synergy/gallery](https://www.renesas.com/synergy/gallery) to download the latest CTW for Synergy before proceeding to any Capacitive Touch Tuning exercises. To further understand this PC-side software tool, see the *Capacitive Touch Workbench User's Manual for Renesas Synergy*.

1.2 Capacitive Touch Tuning support from SSP

The target system needs to run the Synergy CTSU Tuning project with the CTW for Synergy to perform capacitive touch tuning. In addition to the capacitive touch tuning and CTSU driver, the communications framework on USB and UART are used in the tuning project to communicate with the CTW for Synergy. The following sections describe the SSP components used in the capacitive touch tuning projects.

1.2.1 SSP CTSU Tuning Driver

This section describes a capacitive touch tuning driver in the SSP. To create a tuning project from scratch, start by creating a new thread and bring in the CTSU Tuning driver. Add the SSP CTSU tuning block as shown in the following figure.

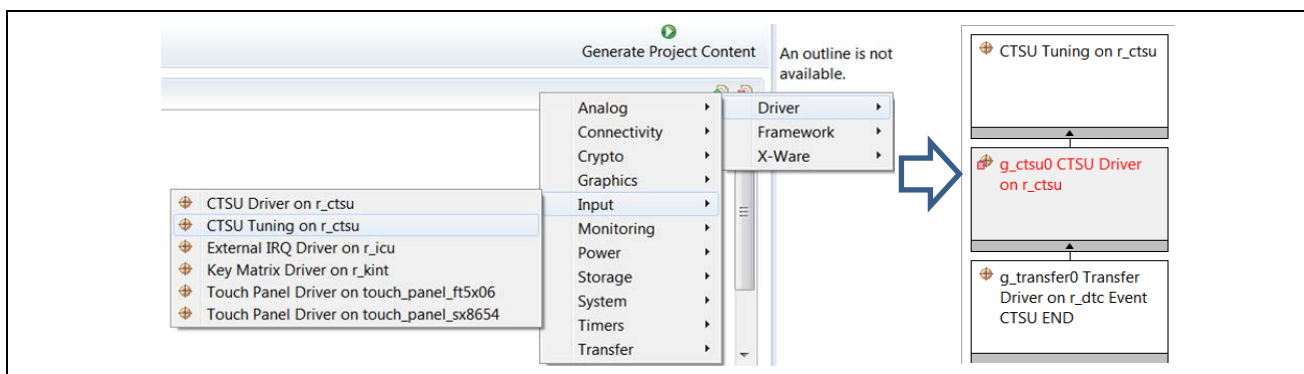

Figure 1. Including the CTSU Tuning Driver

The SSP CTSU tuning driver has three properties to configure.

Note the following about the CTSU tuning driver:

- Two of the properties that are not implemented with the current CTSU tuning driver are: tuning a board with buttons and tuning a board with a slider or wheel. These two properties (buttons, slider or wheel) are not used in the tuning process and are placeholders for future development.
- You need to select the capacitance mode by setting the **Self** or **Mutual Capacitance Mode** property. For the AE-CAP1-BWS button wheels slider board, you will use the **Self-Capacitance Mode**. To work with the AE-CAP1-MC board, choose the **Mutual Capacitance Mode**.

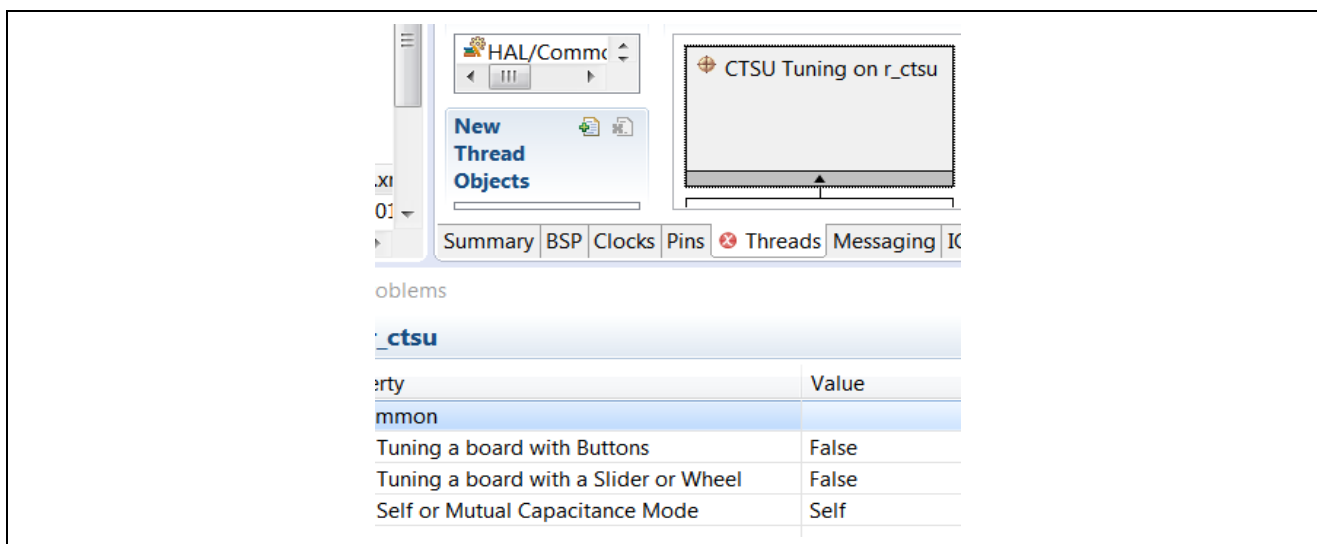

Figure 2. Configuring the tuning driver

With the current SSP CTSU support, this tuning driver is very simple and utilizes the lower layer CTSU HAL driver to perform the tuning process described in the next section.

1.2.2 SSP CTSU HAL Driver

The CTSU Driver is used to initialize the CTSU peripheral to detect a change in capacitance on any of the configured (and enabled) channels, perform requisite filtering, and generate a variety of data that can be used by higher level widget layers like buttons wheel and sliders. The tuning project utilizes this CTSU HAL driver to determine the optimal CTSU setting with help from the tuning algorithms from CTW for Synergy.

The capacitive touch tuning driver automatically adds the SSP CTSU HAL Driver to the Synergy configurator. The following figure shows an example configuration for tuning the AE-CAP1 Button Wheel Slider application board with the AE-CAP-S1 target board.

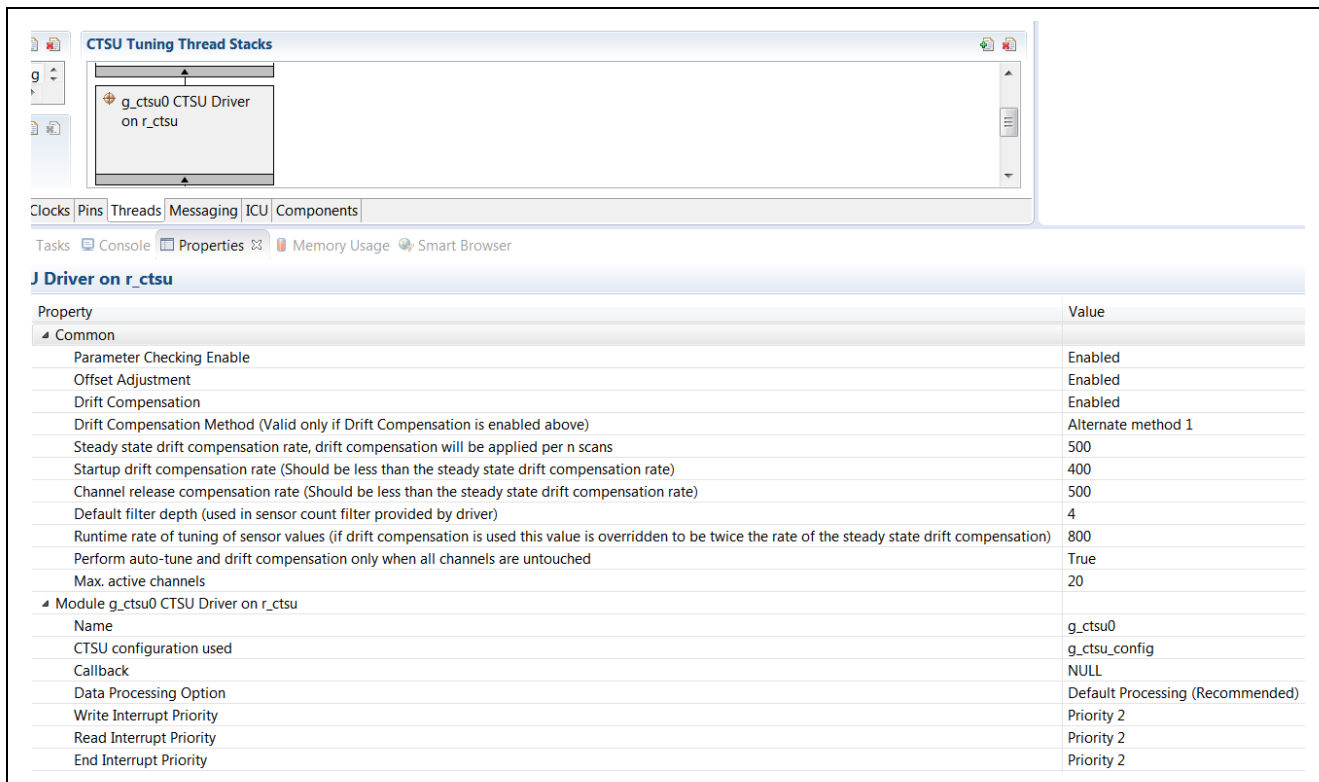

Figure 3. Configuring the CTSU HAL driver

See the *SSP User’s Manual* for definitions of various CTSU HAL Driver properties. Four is the default filter depth recommendation for all the Synergy MCUs. The default setting for the Runtime rate for tuning the sensor values is 800 for the CTSU HAL driver.

Maximum active channels are system dependent. Specify the maximum number of channels that are to be used by the application. In the **Self Capacitance mode**, this is the number of channels used. In **Mutual Capacitance mode**, this is the multiplication result of the receiving channel Rx and transmission channel Tx channels. For example, 4 Rx and 3 Tx channels = 12 Maximum Active Channels.

1.2.3 USB and UART Communication with CTW for Synergy

Capacitive Touch Tuning through CTW for Synergy supports tuning through USB and UART communications. To communicate with the CTW for Synergy, the tuning project includes the SSP communication framework on USB CDC or UART. See the communication framework on USB CDC and *UART Module Guide* for detailed operation.

1.2.3.1 Note on Setting up the Tuning Project with UART

For Capacitive Touch Tuning through UART, the UART baud rate needs to be set to 38,400 as shown in the following figure. This is a requirement from CTW for Synergy.

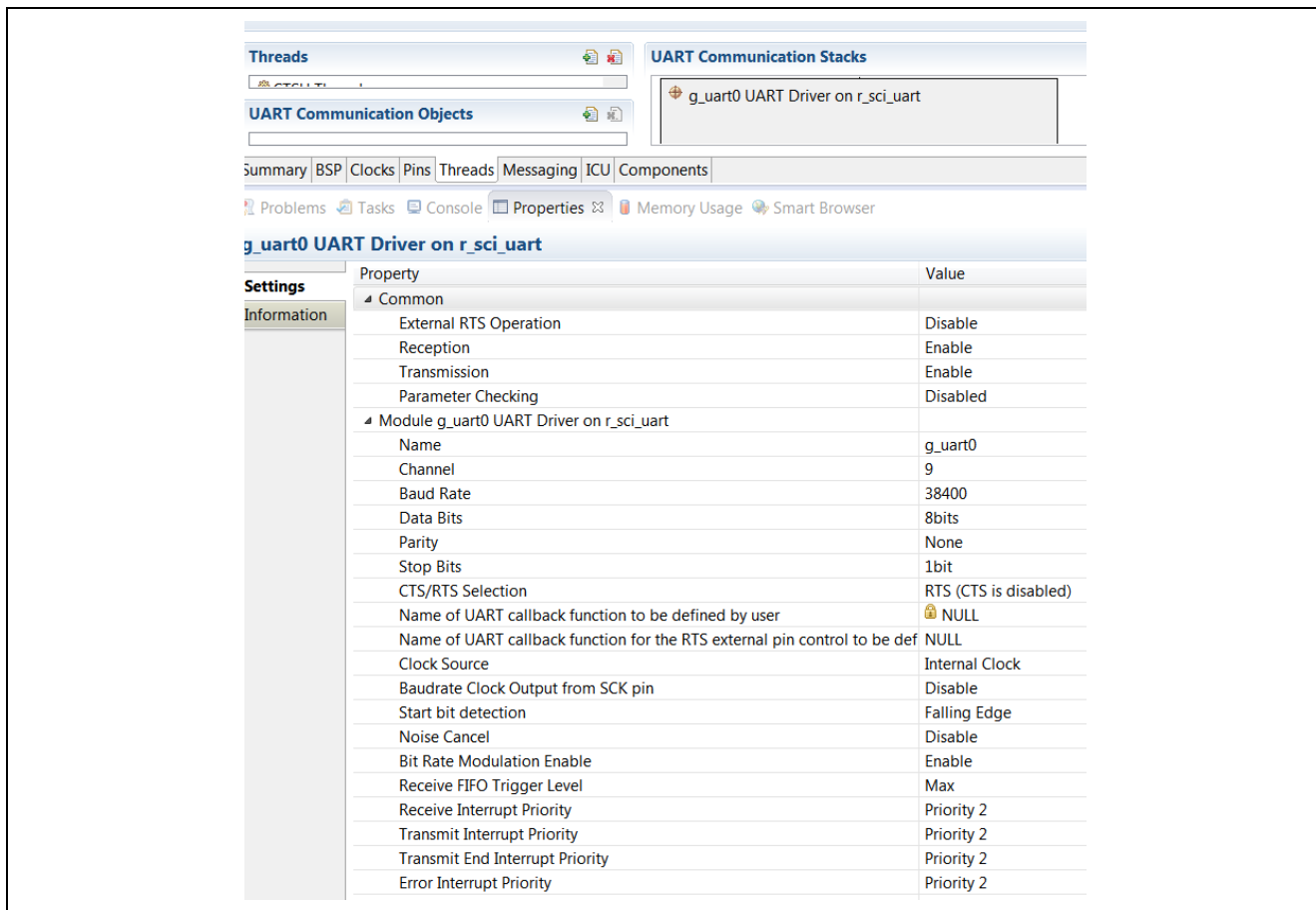

Figure 4. UART Configuration for Tuning

1.2.4 Operational Notes and Limitations of the Current Capacitive Touch Tuning Solution

1.2.4.1 Working with a Custom Capacitive Touch PCB Board

The custom BSP needs to be created first to set all the intended CTSU touch sensing pins. When the custom BSP is selected in the BSP tab, all the CTSU touch sensing pins are automatically selected. You can select any number of the enabled capacitive touch pins during the debugging stage of the tuning project.

1.2.4.2 Limitation on PCLKB Selection in the Capacitive Touch Application

The current version of the CTW for Synergy has limitations on the PCLKB frequency setting in capacitive touch tuning and application. Only PCLKB settings 24 MHz or 32 MHz are supported.

In addition, capacitive touch tuning uses USB to communicate with the CTW for Synergy. Communication through USB imposes additional system clock setting requirement.

These limitations (Capacitive Touch Tuning and USB usage) have implications on the maximum CPU frequencies that can be run with capacitive touch applications. See the following table for details.

Table 1. CPU Clock

Synergy MCU	Max CPU clock	CPU clock with tuning project
S124	32 MHz	24 MHz
S3A7	48 MHz	48 MHz
S5D9	120 MHz	96 MHz
S7G2	240 MHz	192 MHz

1.2.4.3 Limitations on the UART Baud Rate during Tuning with CTW for Synergy

The current version of CTW for Synergy only supports tuning through the UART port on the target board at baud rate 38,400. See Figure 4 for more information on the UART configuration for tuning with CTW for Synergy.

1.2.4.4 Limitations on Monitoring after Tuning

The slider window and wheel window are not active when activating the monitor window after tuning, before the system is power recycled. See section 3.5 to understand monitoring after tuning.

1.2.4.5 Monitoring Result Using Unfiltered Data

This version of the CTSU driver does not allow filtered data to be sent to the CTW for Synergy for monitoring. Raw data is sent to CTW for Synergy for monitoring. As a result, noise is observed, then compared with the filtered data in monitoring functionality.

2. Capacitive Touch Tuning Operating Overview

The following flowchart explains the high-level operation sequence of a Capacitive Touch System and its interaction with the various software components in the capacitive touch solution.

At a high level, the operational sequence is as follows:

1. You first use the capacitive touch tuning software project and the CTW for Synergy to generate the capacitive touch CTSU configurations together with the touch thresholds and hysteresis.
2. Next, you copy the tuning result to the application project to perform touch detection using the SSP Capacitive Touch Framework.

This application project focuses on the operation related to the CTW for Synergy using the Capacitive Touch Tuning Software Projects. The operation with the application is described in other application projects. See section 3.1 for the related touch detection application projects.

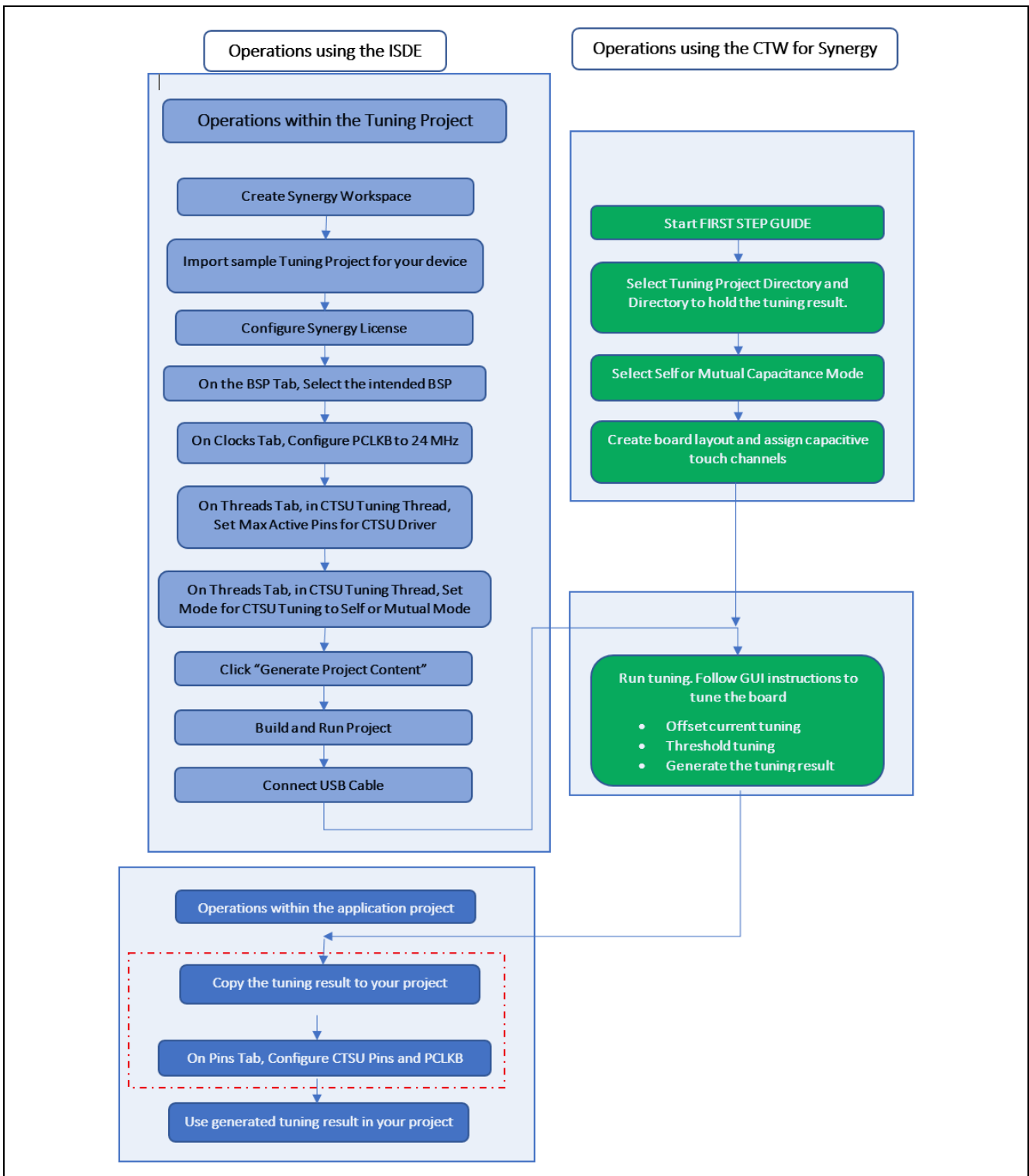

Figure 5. Capacitive Touch Operational Flow Chart

3. Capacitive Touch Tuning with CTW for Synergy

3.1 Example Capacitive Touch Tuning Software Projects

In this application project there are several references to Capacitive Touch Tuning Software Projects.

Sample tuning projects for AE-CAP1, SK-S7G2 (v3.2 or later), DK-S124, and PK-S5D9 are included to use with CTW for Synergy.

These sample projects can be used as start-up reference projects when creating a Capacitive Touch Tuning Application Project for your own board:

- `Capacitive_Touch_Tuning_Projects_AE_CAP1.zip`
- `Capacitive_Touch_Tuning_Projects_SK_S7G2.zip`
- `Capacitive_Touch_Tuning_Projects_DK_S124.zip`
- `Capacitive_Touch_Tuning_Projects_PK_S5D9.zip`

Following table lists the Capacitive Touch Tuning Projects included inside these zip files.

Table 2. Capacitive Touch Tuning Projects Included in this Application Project

Tuning Software Projects	Project Description
<code>Tuning_AE_CAP_S124_BWS</code>	• Tuning Project for system with AE-CAP1-S124 connected with AE-CAP1-BWS board via USB
<code>Tuning_AE_CAP_S124_BWS_UART</code>	• Tuning Project for system with AE-CAP1-S124 connected with AE-CAP1-BWS board via UART
<code>Tuning_AE_CAP_S124_MT</code>	• Tuning Project for system with AE-CAP1-S124 connected with AE-CAP1-MC board via USB
<code>Tuning_AE_CAP_S124_MT_UART</code>	• Tuning Project for system with AE-CAP1-S124 connected with AE-CAP1-MC board via UART
<code>Tuning_AE_CAP_S124_ST</code>	• Tuning Project for system with AE-CAP1-S124 connected with AE-CAP1-SC board via USB
<code>Tuning_AE_CAP_S124_ST_UART</code>	• Tuning Project for system with AE-CAP1-S124 connected with AE-CAP1-SC board via UART
<code>Tuning_AE_CAP_S3A7_BWS</code>	• Tuning Project for system with AE-CAP1-S3A7 connected with AE-CAP1-BWS board
<code>Tuning_AE_CAP_S3A7_MT</code>	• Tuning Project for system with AE-CAP1-S3A7 connected with AE-CAP1-MC board
<code>Tuning_AE_CAP_S3A7_ST</code>	• Tuning Project for system with AE-CAP1-S3A7 connected with AE-CAP1-SC board
<code>Tuning_DK_S124</code>	• Tuning Project for DK-S124
<code>Tuning_SK_S7G2</code>	• Tuning Project for SK-S7G2 (Version 3.2 and later)
<code>Tuning_PK_S5D9</code>	• Tuning Project for PK_S5D9

3.1.1 Importing the CTSU Tuning Project

The general tuning procedure is common to all hardware kits. This Application Note uses the Capacitive Touch System for the AE-CAP1-S1 and AE-CAP1-BWS board as an example to explain the general procedure. You can reference this procedure and the sensor layout information in section 5 to perform Capacitive Touch Tuning for other kits.

See the following notes when importing the CTSU Tuning Project:

- See the *Renesas Synergy™ Project Import Guide* (r11an0023eu0121-synergy-ssp-import-guide.pdf), included in this package, for instructions on importing the projects into e² studio (or IAR EW for Synergy) and building/running the application.
- The included **Capacitive Touch Tuning Projects AE_CAP1.zip** file contains several tuning projects. **Tuning_AE_CAP1_S124_BWS** is used as an example when describing the tuning steps.

Note: When working with all tuning projects, you need to follow the same steps.

- To work with the AE-CAP1 Sample Projects in e² studio ISDE, the AE-CAP1 BSP files **Renesas.Synergy_Board_s124_ae_cap1.1.7.0.pack** and **Renesas.Synergy_board_s3a7_ae_cap1.1.7.0.pack** (for 1.7.0 pack) need to be placed in the your e² studio installation folder \\<your e2_studio folder>\internal\projectgen\arm\Packs.
- To work with the AE-CAP1 Sample Projects in IAR Embedded Workbench, the **AE-CAP1 BSP** files need to be placed in your IAR EW for Synergy SCC folder; <your SSC folder>\internal\projectgen\arm\Packs.
- Import **Tuning_AE_CAP1_S124_BWS** (for USB connection) or **Tuning_AE_CAP1_S124_BWS_UART** (for UART connection) and set up the license file. Review the tuning project settings below before proceeding to the tuning steps.

3.1.2 Configurations of the Capacitive Touch Tuning Project

Reviewing the Synergy configuration of the **Tuning_AE_CAP1_S124_BWS** helps us understand the various configuration properties that a capacitive touch tuning project needs to setup.

In case of error in your tuning process, following are some of the aspects you need to take care of from the software side:

1. Open the **Synergy Configuration** view. You can do this by double-clicking the **configuration.xml** file in the **Project Explorer** pane and changing the perspective to **Synergy Configuration**.
2. In the **Synergy Configuration** view, select the **Pins** tab and expand the peripherals entry to select **CTSU**. Observe the CTSU pins that are used for Capacitive Touch in your project. You will notice that all the following 28 capacitive touch pins that are assigned as capacitive touch sensing pins on the AE-CAP1-S1 board are enabled. See the hardware schematic to understand the hardware pins used in the AE-CAP1-BWS board. Although the AE-CAP1-BWS board only uses 20 out of the 28 capacitive touch pins, it is alright to have all the touch sensing pins enabled in the tuning project. The tuning layout determines the group of pins that will be tuned.

Table 3. Hardware configuration with AE-CAP1-S1 and AE-CAP1-BWS

S124 Pin name	Function
TSCAP	CTSU power stabilization
TS00-TS02, TS04-TS09, TS12-TS28, TS30-TS31	Capacitive touch sensing
TS03, TS10, TS11 are assigned other functionalities	See schematic
TS29 not functioning	See hardware user manual

3. Select the **Clocks** tab to confirm the clocks, including the PCLKB, are identical to the eventual user application project where the results of this tuning procedure are used. For the **Tuning_AE_CAP1_S124_BWS** tuning project, the PCLKB is set to 24 MHz.
4. In the **Synergy Configuration** view, select the **Threads** tab.
5. Then select the **CTSU Tuning Thread**.
6. On the right, under **CTSU Tuning Thread Stacks**, select **g_ctsu CTSU driver** on **r_ctsu**. Confirm that the CTSU driver has the same configuration as in Figure 3.
7. In the **Properties** window, confirm that the **Maximum Active Channels** is set to **20**.

Note: In **Self-Capacitance Mode**, the **Maximum Active Channels** is the number of channels used. In **Mutual-Capacitance Mode**, this value is the maximum number of channel combinations. For example, in **Mutual-Capacitance Mode** there are three (3) receive channels and four (4) transmit channels, and the **Maximum Active Channels** entry would be **12**.

8. Under the **CTSU Tuning Thread Stacks**, select **CTSU Tuning** on **r_ctsu**.

In the **Properties** window, confirm that **Self-Capacitance Mode** is selected for the AE-CAP1-BWS board tuning. Leave the other as shown in Figure 2.

3.2 Start the CTW for Synergy

1. Open the CTW for Synergy. Click **START** as shown in Figure 6.



Figure 6. Start FIRST STEP GUIDE

2. Click **Next** as shown in Figure 7.



Figure 7. Major steps in tuning with CTW for Synergy

3. Under **Application Project Directory** in Figure 8, browse to the root directory of the application project if you have created one. After the tuning is complete, the application creates the **captouch_configs** folder in the **\src** directory of the application project. This folder stores the tuning results that your application

uses to detect the capacitive touch. You can also save the files generated by the project to an existing folder on your computer (for example **C:\workspace\MyCTSUApplication** as shown in the following figure), and then later copy the generated folder to your application project's **src** folder.

- Under the **Tuning Project Directory** shown in the following figure, browse to the directory where the e² studio tuning project is located. Then click **Next**. The application reads configuration items like PCLKB speed and configured touch sensor information from the tuning project.

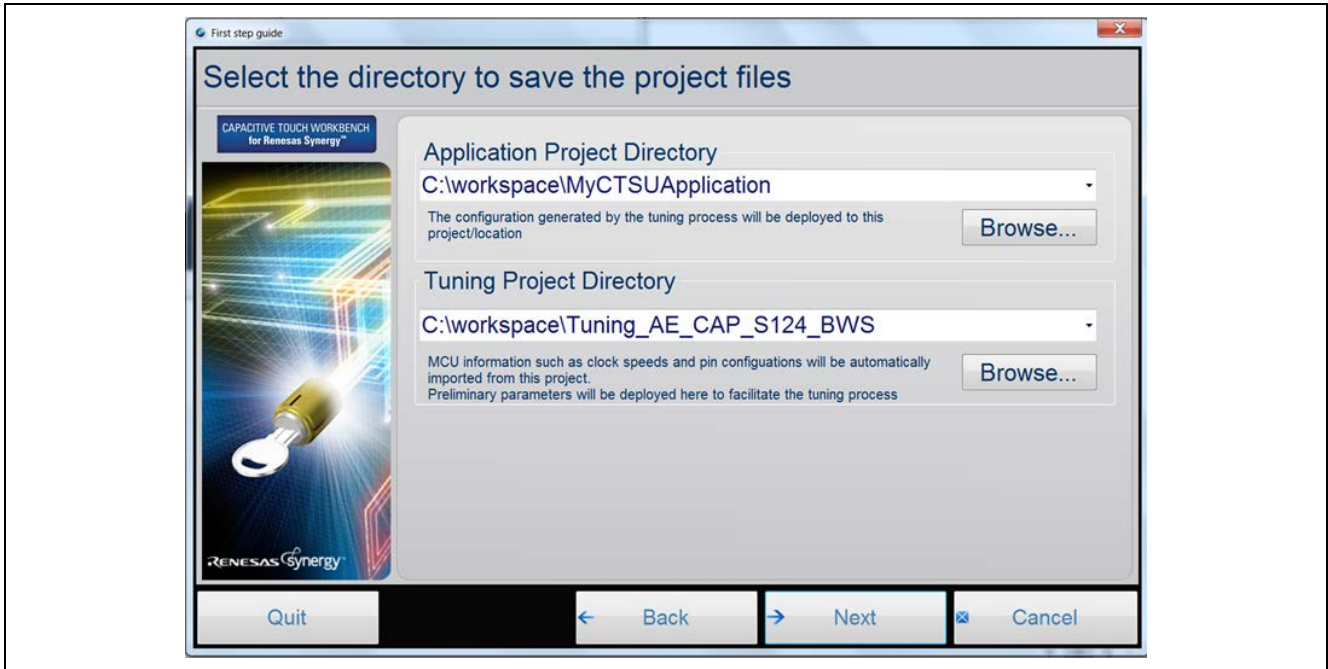

Figure 8. Select Tuning Project and Application Project Directories

- Select the **Self capacitance method** shown in the following figure and click **Next**.

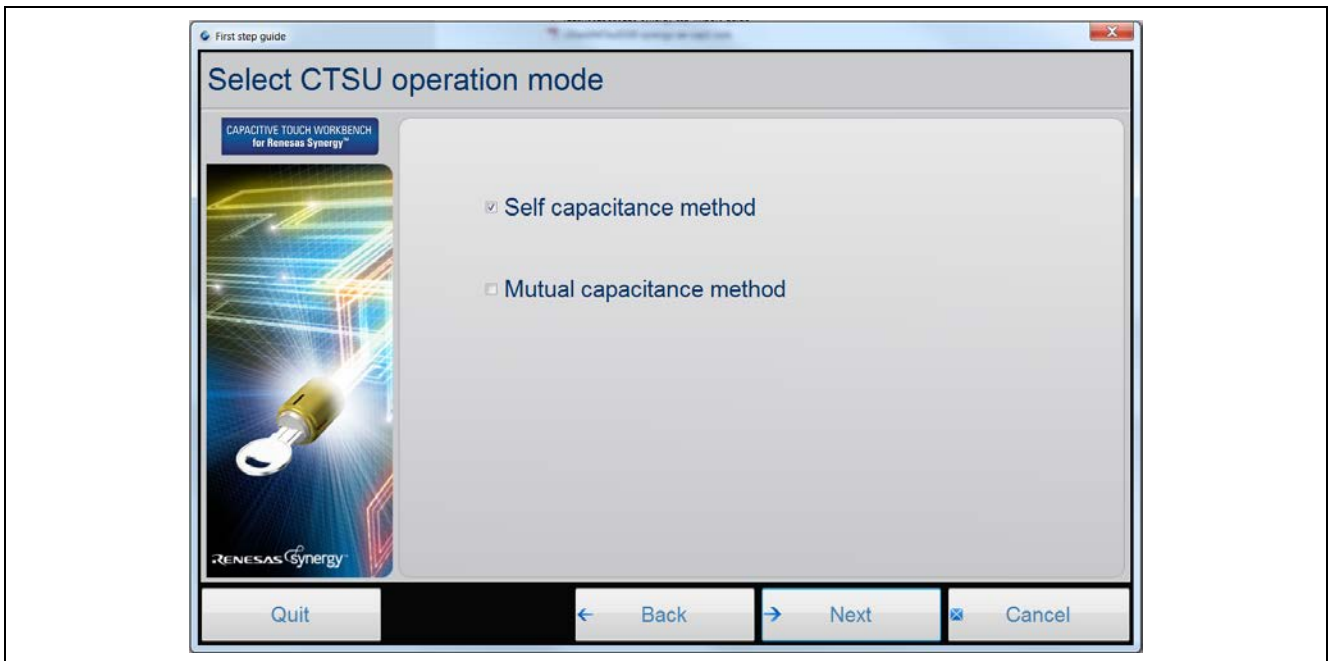

Figure 9. Select the CTSU operation mode

The capacitance method selected here should match the configuration in section 3.1.2, step 8.

6. Create the layout for your board by using the widgets on the right-hand pane in the following figure. You can add buttons, sliders and wheels using this pane as illustrated.
 - To specify the CTSU channels used by each button, right-click the widget and select **Channel** as shown in the following figure. Follow the same procedure to create all three buttons.

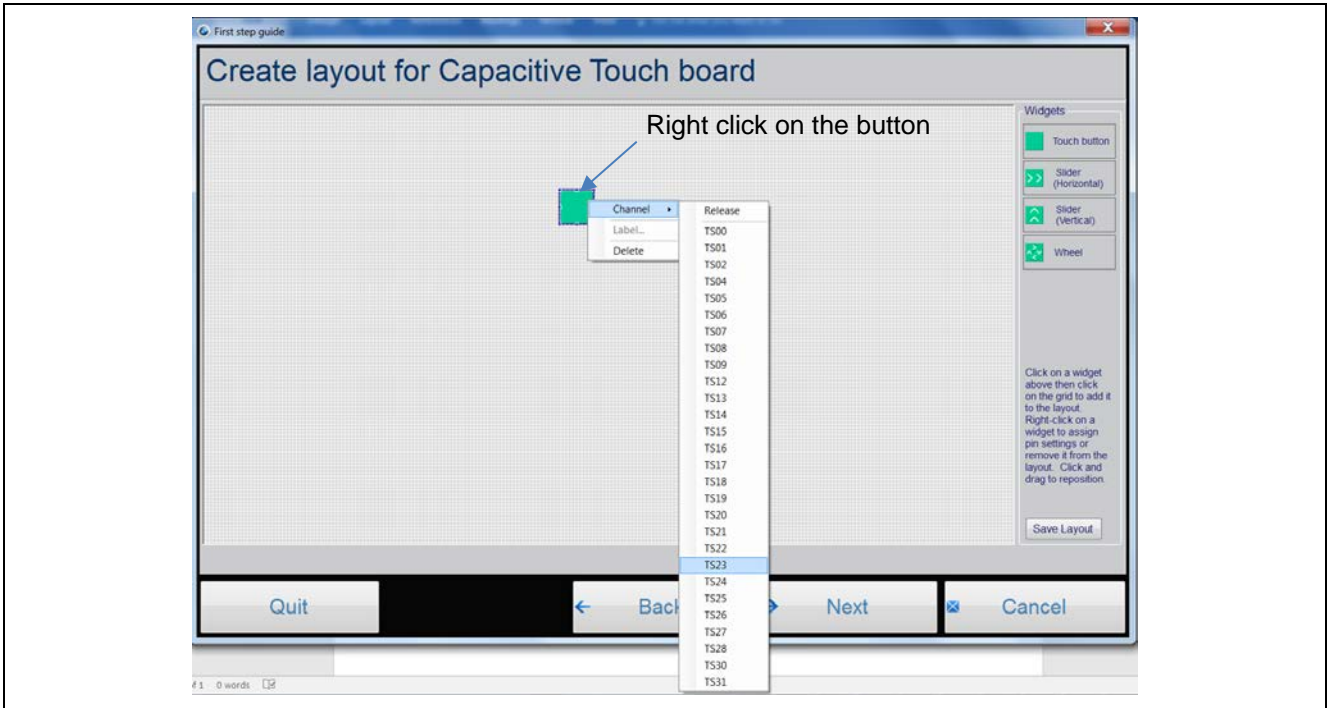

Figure 10. Add Button to the layout

Note: In **Self-Capacitance** mode, only a single channel needs to be specified. In **Mutual-Capacitance** mode, specify both transmit and receive channels. There is a **Save Layout** button on the right corner of this window. Once all the touch sensors are assigned, you can save this layout for future tuning sessions. See the *CTW for Synergy User's Manual* to understand the usage of the **Save Layout** button.

- To configure the slider and wheel, right-click the object. Select **Setup**. Change the number of channels used on your board to specify the channels used as shown in the following graphic.

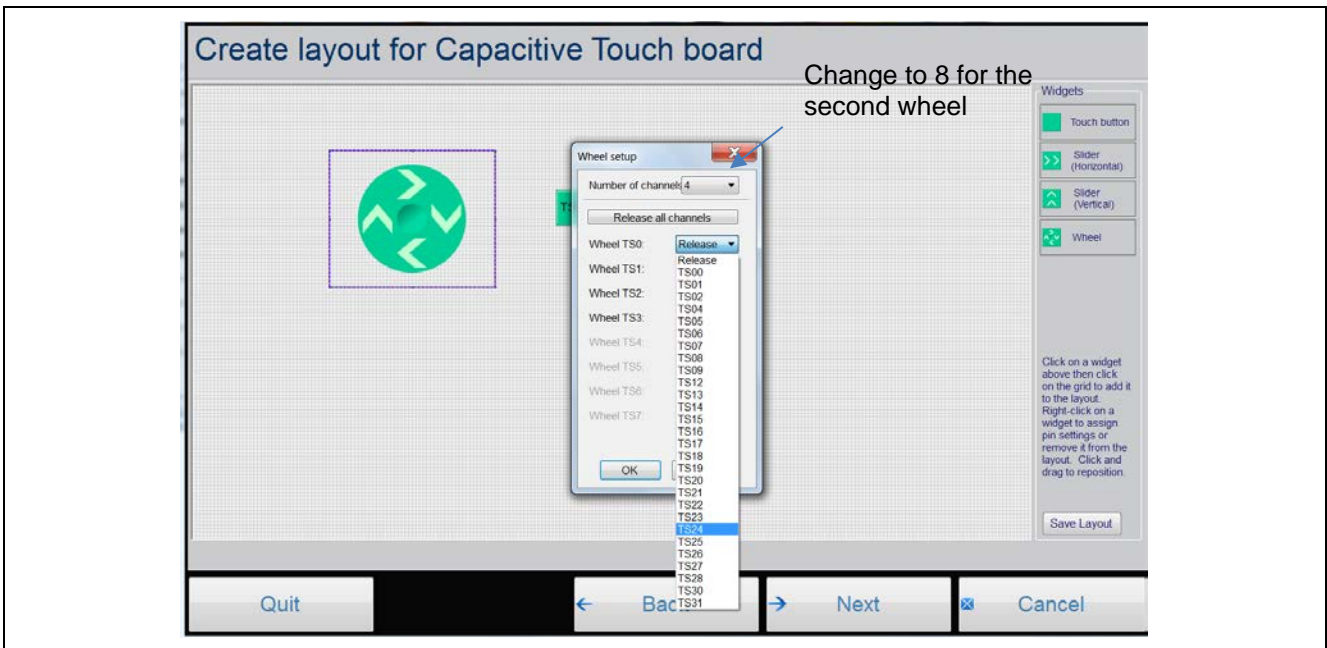

Figure 11. Add Wheel and Slider to the layout

Note: When configuring the slider and wheel on the AE-CAP1-BWS board, the sequence of channels assigned must match the hardware layout of the board.

- To get the slider channel order displayed, channels were added in this order: TS05, TS04, TS01, TS00, and TS02.
 - To get the 4-sensor wheel (Wheel 0) channel order displayed, channels were added in this order: TS24, TS20, TS27, and TS30 clockwise.
 - To get the 8-sensor wheel (Wheel 1) channel order displayed, channels were added in this order: TS22, TS19, TS18, TS17, TS8, TS28, TS31, and TS25 clockwise.
 - To change the slider and wheel orientation, right-click the widget to change the orientation.
- In case of the slider, the arrows point to the channel that generates the highest coordinate values in the callback during its operation. Only **Self-Capacitance** mode is currently supported for sliders and wheels.
 - The following graphic shows the finished AE-CAP1-BWS board layout when controlled by AE-CAP1-S1 MCU board. Click **Next**.

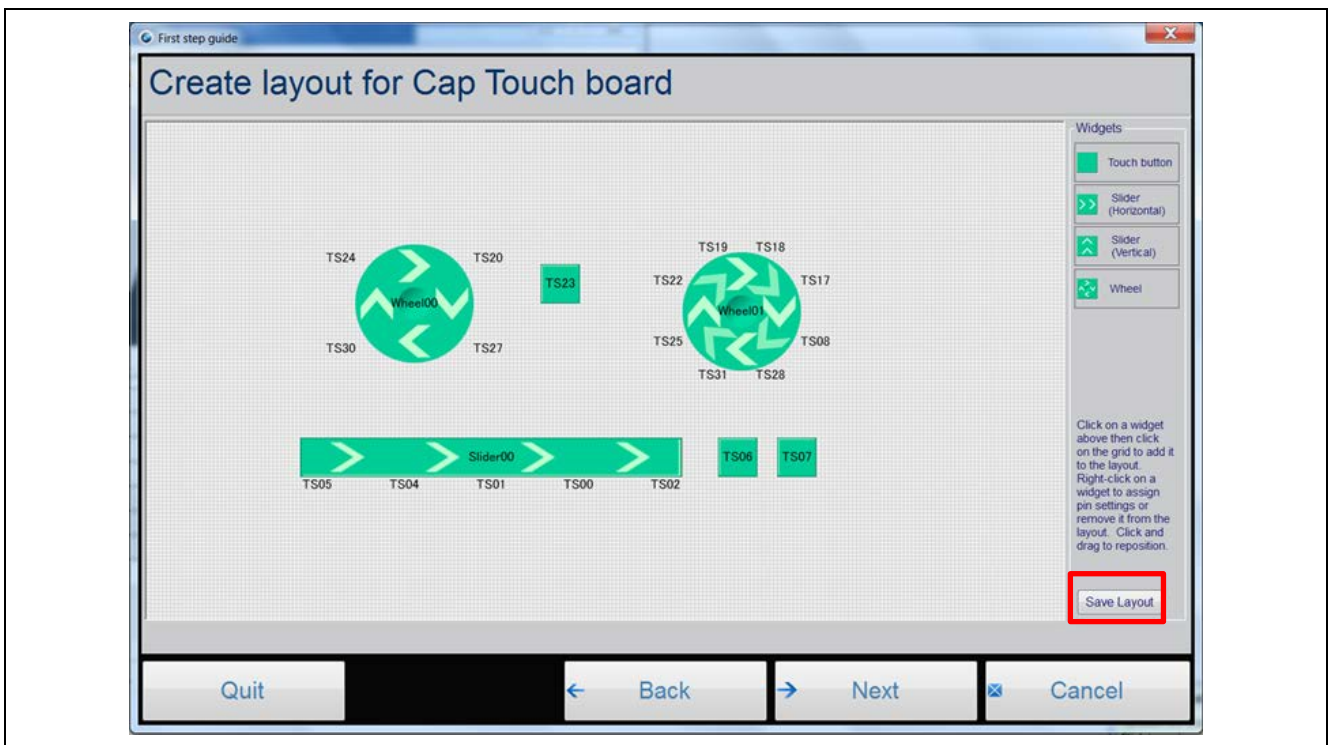

Figure 12. AE-CAP1-BWS Tuning Layout

7. The following graphic shows the default aggregate resistance values for each configured channel. The default values are recommended for all designs. The value should be adjusted by you depending on noise environment of the application.

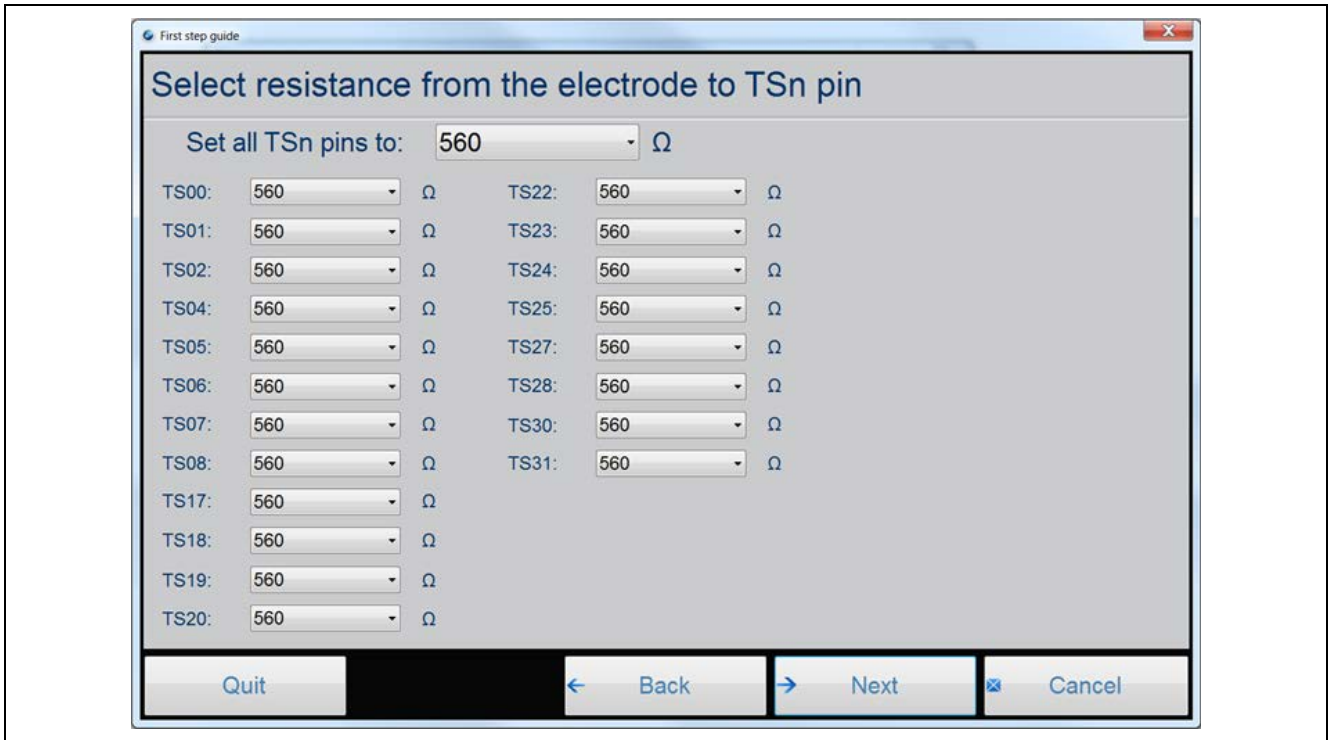

Figure 13. Select resistance from the electrode to TSn pin

When you reach the following screen, the application has internally generated the placeholder arrays and other structures required for this configuration.

Note: Do not click **Next**. Go to section 3.3.2 to connect your PC to the target MCU via USB. The beginning of section 3.4 instructs you on how to come back to this screen to continue the tuning process.

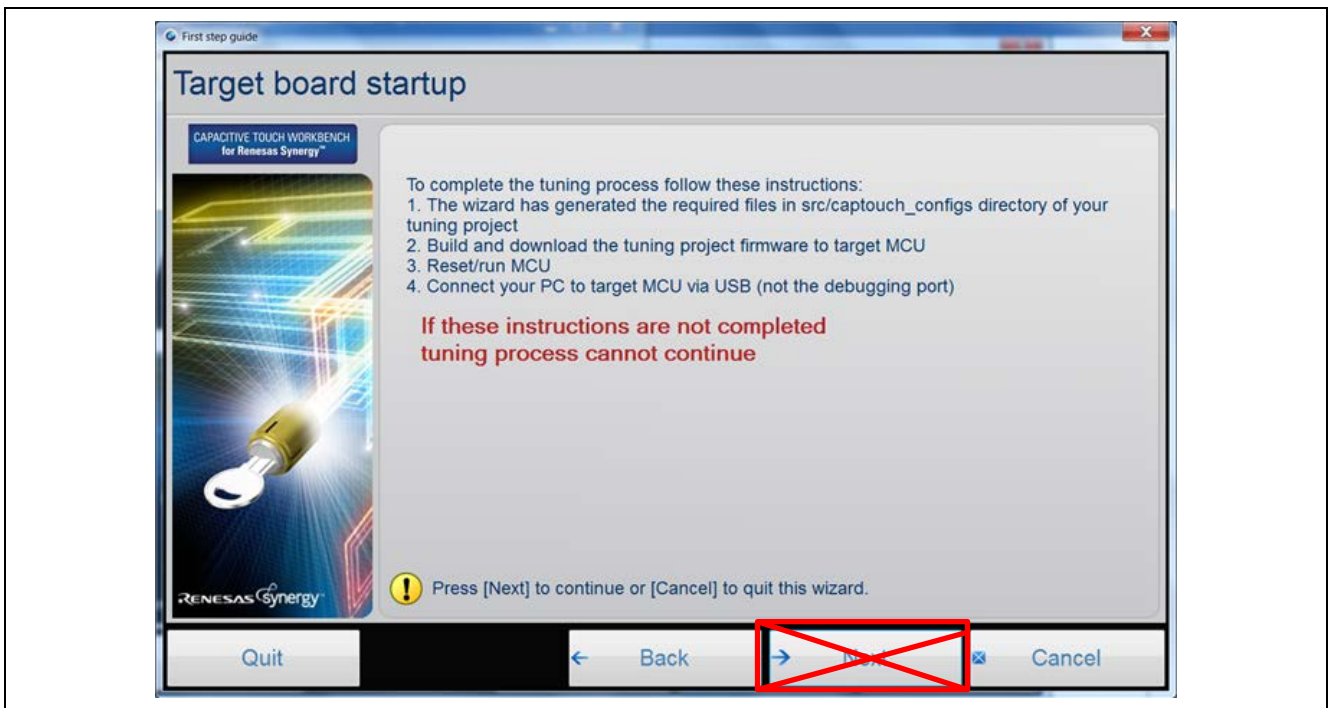

Figure 14. Target board startup

3.3 Running the CTSU Tuning Project

3.3.1 Powering up the AE-CAP1-S1 and AE-CAP1-BWS Board

At this point, run the CTSU tuning project. First set up the AE-CAP1-S1 and AE-CAP1-BWS boards:

1. Set **J2** on AE-CAP1-S1 to **5V USB**.
2. Connect the **AE-CAP1-S1** and **AE-CAP1-BWS** board together.
3. Connect **J8** and **J10** on the AE-CAP1-S1 board to the **PC** through USB cables.
4. Ensure that **J4** on AE-CAP1-S1 board is **open**.

Special Note on connecting the UART tuning with AE-CAP1-S124:

- To use the UART tuning program, **Tuning_AE_CAP1_S124_BWS_UART**, you need to **solder a pin header** on **J9** and connect a **USB to Serial cable** as shown in the following figure.

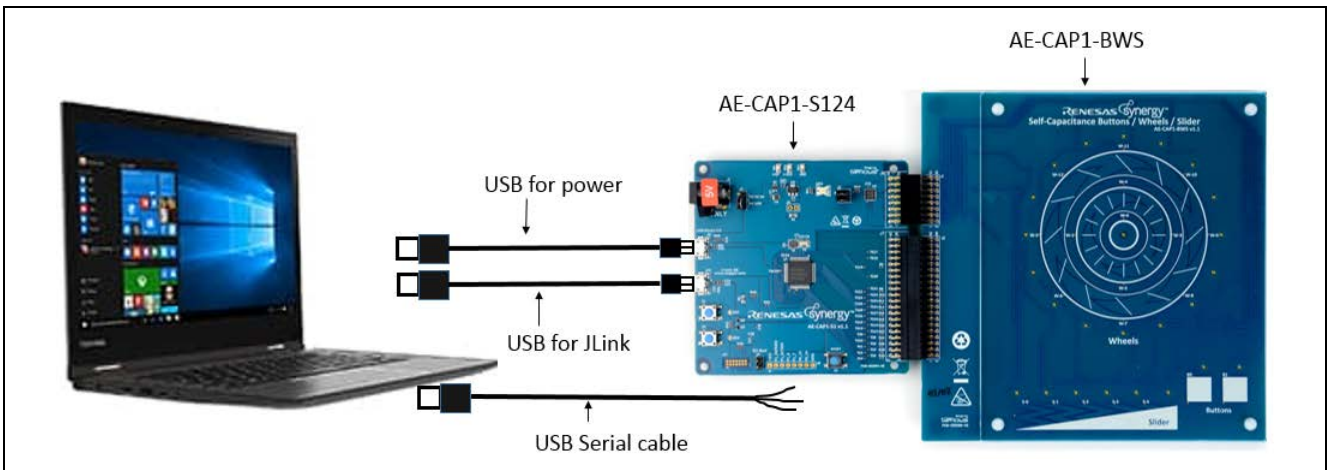

Figure 15. Hardware setup for AE-CAP1-S1 and AE-CAP1-BWS

Following are the details on the UART pin connection. Remove jumpers from J5 (leave J5 open). The UART pins are shared with the panel board I²C-led control pins. Also, this hardware setup is required for tuning the AE-CAP1 kit with AE-CAP1-S124 and the AE-CAP1-MC or AE-CAP1-SC systems.

Table 4. UART Pin Connection

Pins on J9 (AE-CAP1-S1)	Serial to USB converter
Pin 2 (P1_10/EXD9/SCL9)	TXD
Pin 3 (P1_9/TXD9/SDA9)	RXD
Pin 8 (GND)	GND

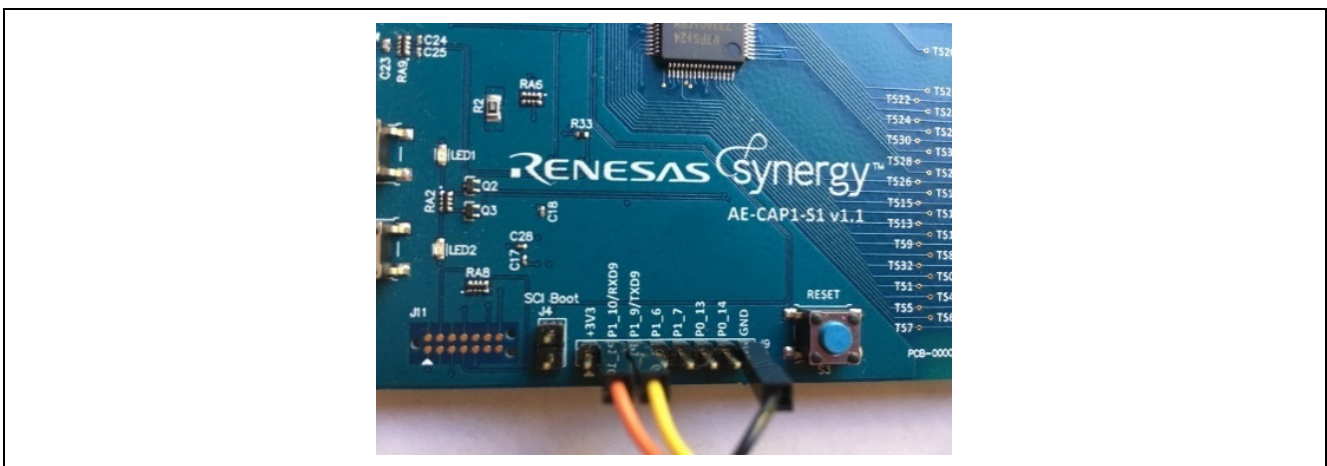

Figure 16. Example Connection

5. Build the **Synergy Tuning Project**.
6. Connect to the debugger, then download and run the project.
7. If you are running the **Tuning_AE_CAP1_S124_BWS**, go to section 3.3.2 to ensure the USB CDC device enumeration is working properly on the PC.
8. Skip this section when tuning with S124 UART port (**Tuning_AE_CAP1_S124_BWS_UART**).
 - A. **USB Serial Device (COMx)** to enumerate with the serial-to-USB converter on both Windows 7 and Windows 10.
 - B. **Tuning_AE_CAP1_S124_BWS_UART** project configures the UART baud rate to 38,400 (this baud rate is for UART tuning only. Tuning with USB can use any of the available baud rate). This rate is a requirement from CTW for Synergy.

3.3.2 Install USB CDC Driver on Windows

The **Tuning_AE_CAP1_S124_BWS** software uses the USB to communicate with CTW for Synergy. To work with Windows 10, there is no need to install a USB driver. USB Serial Device enumeration happens with sample projects shown in the following figure.

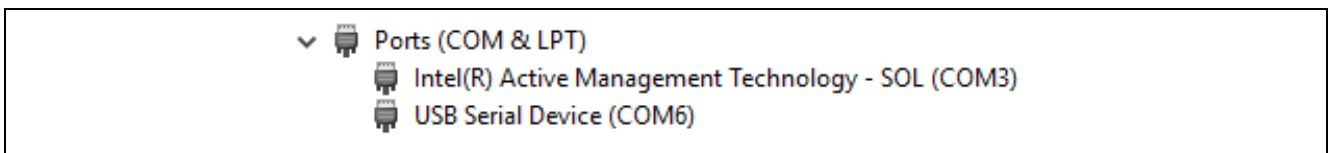

Figure 17. Enumeration of USB CDC COM port on Windows 10

To work with Windows 7, you need to install the **USB CDC/ACM device driver**. The USB driver is attached with this application project (**Windows_USB_serial_driver.zip**). Unzip it to the folder `\Windows_USB_serial_driver`.

1. Upon downloading and running the application, the CDC/ACM device displays in the **Device Manager** of your PC under the **Universal Serial Bus Controller** group as **UNKNOWN DEVICE**.
2. Right-click this device and select **Update Driver Software**.
3. When prompted for the location of the drivers, browse to the location you created previously `\Windows_USB_serial_driver`.
4. Once the driver is updated, a new COM device shows up in the **Device Manager** as shown in the following figure.

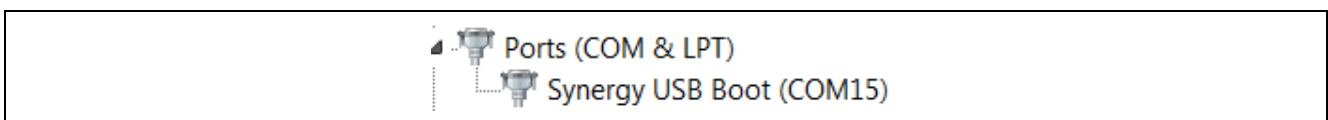

Figure 18. Enumeration of USB CDC COM port on Windows 7

3.4 Continue and Finish Tuning with CTW for Synergy

Once the USB CDC COM port is properly recognized by Windows 10, return to the CTW for Synergy and continue from where you left in section 3.2, step 8. Click **Next** in Figure 14 to connect to the GUI.

1. Click **Next** (as shown in Figure 19) to start parasitic capacitance measurement.

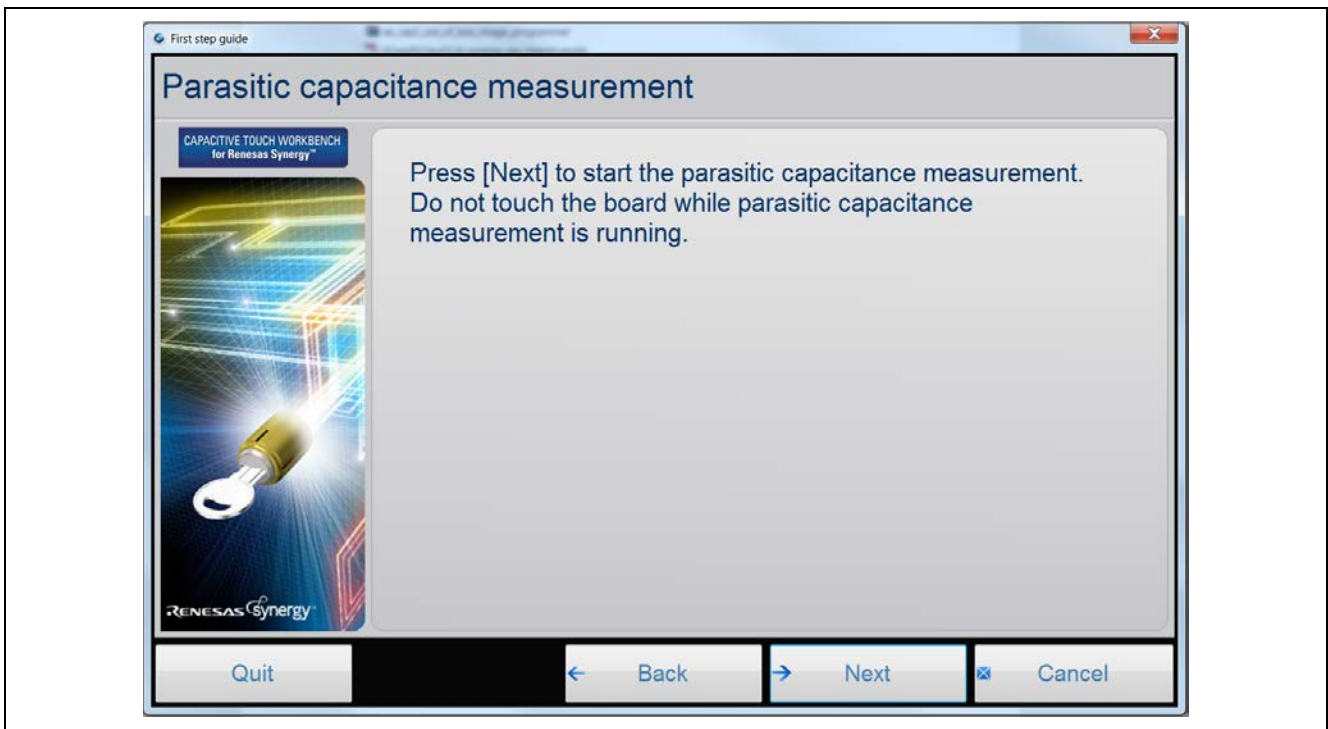

Figure 19. Parasitic Capacitance Measurement

This step does not require your intervention. Do not touch the sensors during this process.

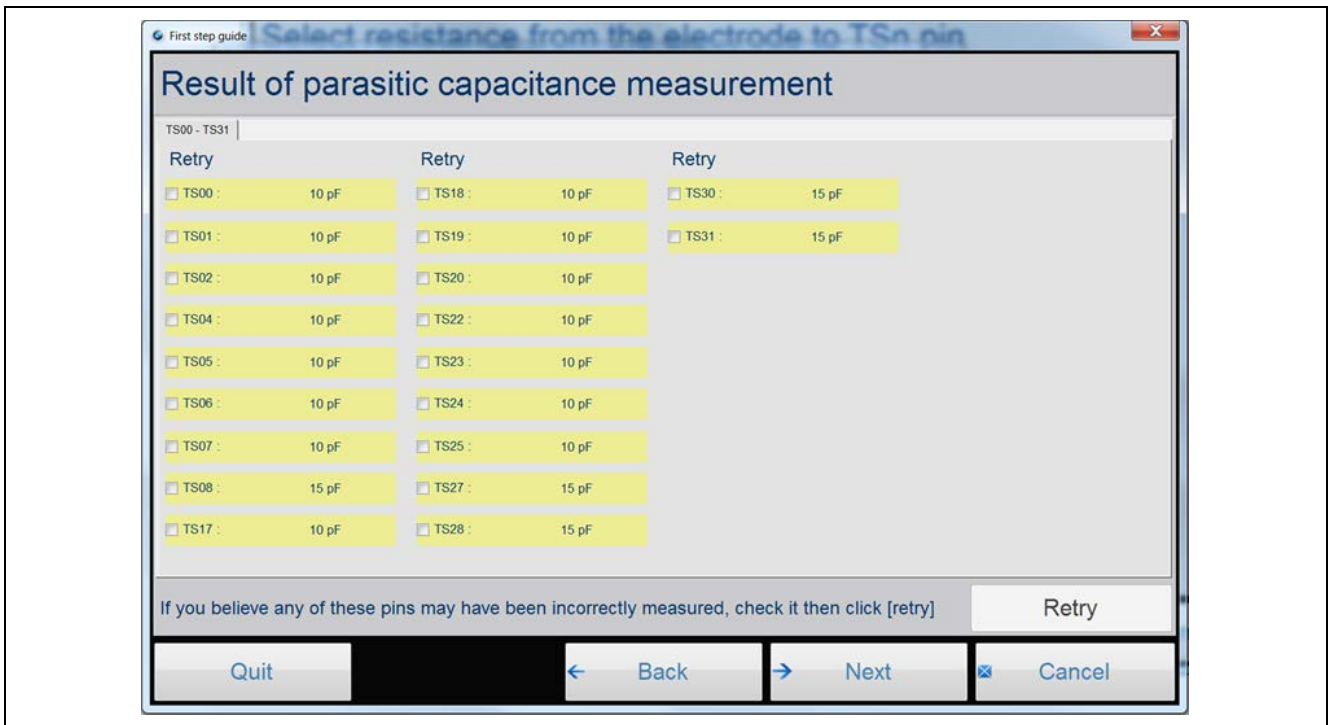

Figure 20. Result of Parasitic Capacitance Measurement

- Click **Next** as shown in Figure 21 to start **Offset current tuning**.
This step does not require your intervention and takes a few minutes to complete, depending on the number of channels being tuned. Do not touch the sensors during this process.

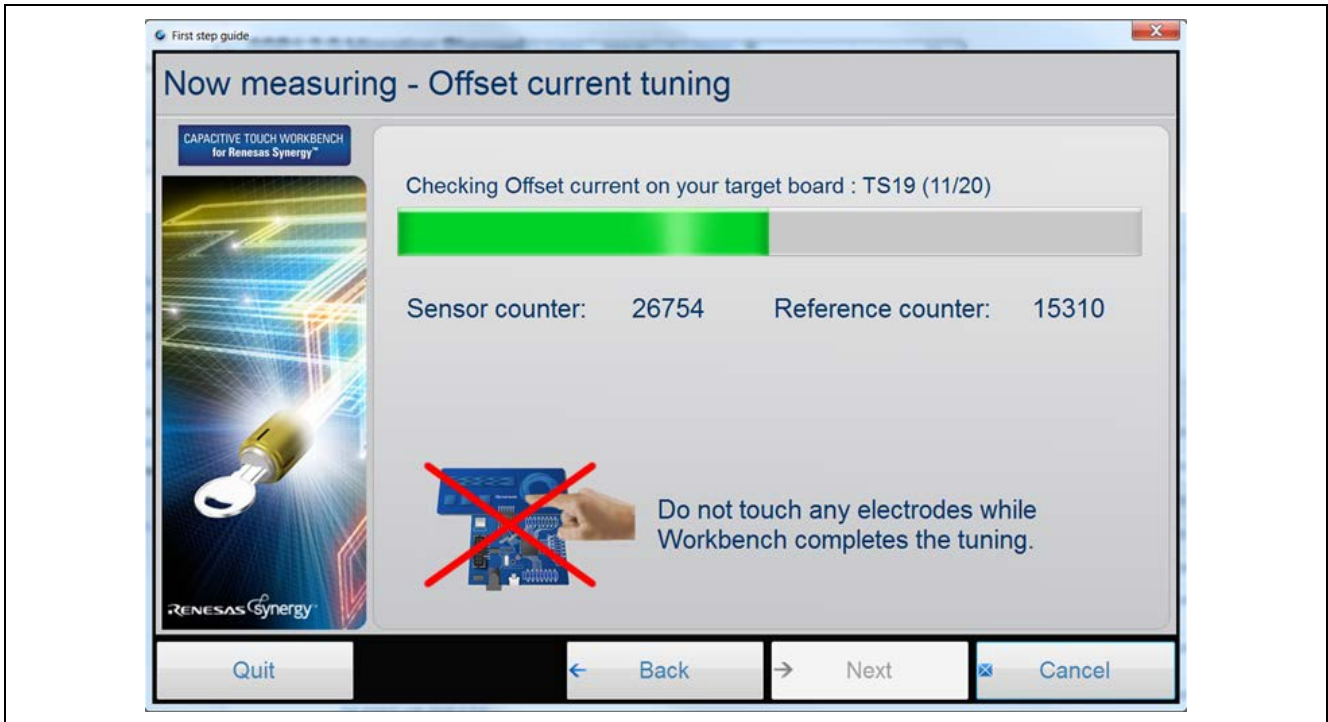

Figure 21. Offset Current Tuning

The Offset tuning results show the chosen drive frequency for each channel.

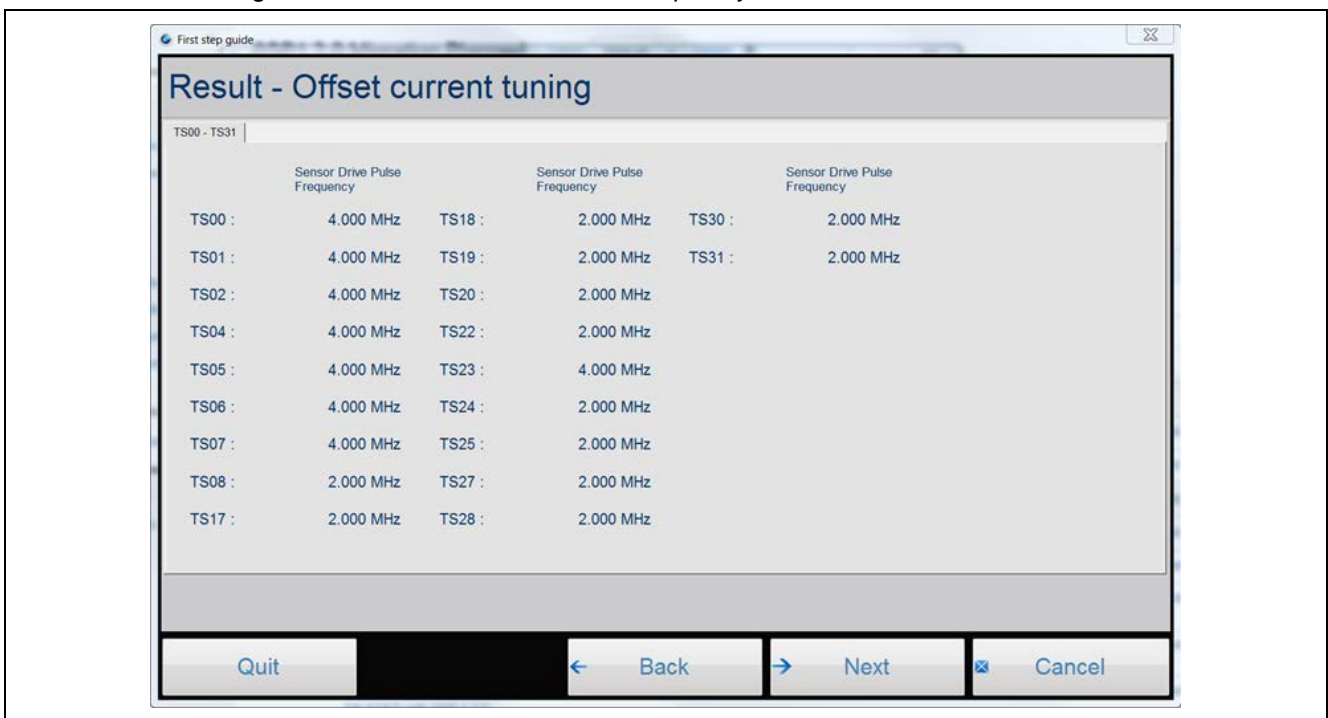

Figure 22. Result - Offset Current Tuning

If the Sensor counter and Reference counter values remain 0 during this step, and the progress bar is moving, then the USB connection was not successful. You are advised to confirm the USB enumeration and restart the tuning process before continuing to the next step. See the document, *Communication Framework on USB CDC Module Guide*, to resolve USB communication-related issues.

3. Click **Next** as shown in the following figure to start **Sensitivity Tuning**.



Figure 23. Sensitivity Tuning

4. The following steps require your intervention. See section 5.1.1 to match the button TS numbers to the buttons on AE-CAP1-BWS.

For button sensitivity tuning shown in the following figure, these actions below are required.

- A. When prompted, apply **maximal** touch. This entails covering the entire sensor pad to the specified sensor. Press **Y** on the PC while touching the button.
- B. Apply **normal** touch three times. This means covering the sensor by 70% to 80% of the sensor area. Press **Y** on the PC each time while touching the button. Depending on the noise level in the application environment, the definition of normal press may differ in your application. This is the expected pressing method for the sensor touch detection in a real application.

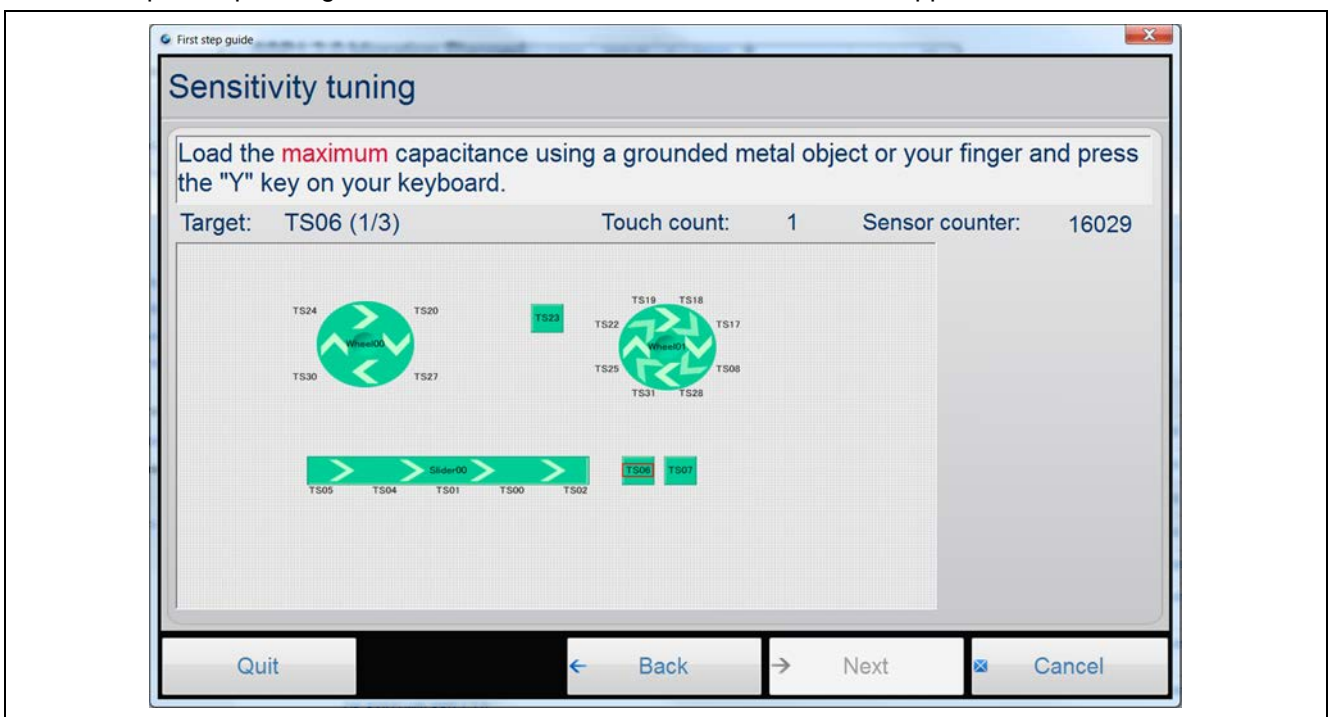

Figure 24. Sensitivity Tuning for Buttons

Repeat the sensitivity tuning process for all the buttons. The sensor count should increase with self-capacitive buttons upon pressing, compared with the released state. Note that for mutual capacitive touch buttons, the sensor count should decrease with mutual-capacitive touch button upon pressing compared with released state.

- The slider and wheel **Sensitivity Tuning** instructions require you to slide a finger over the slider/wheel a few times when prompted by the GUI as shown in the following figure. You do not need to hold the touch when pressing the Y key for slider and wheel sensitivity tuning.

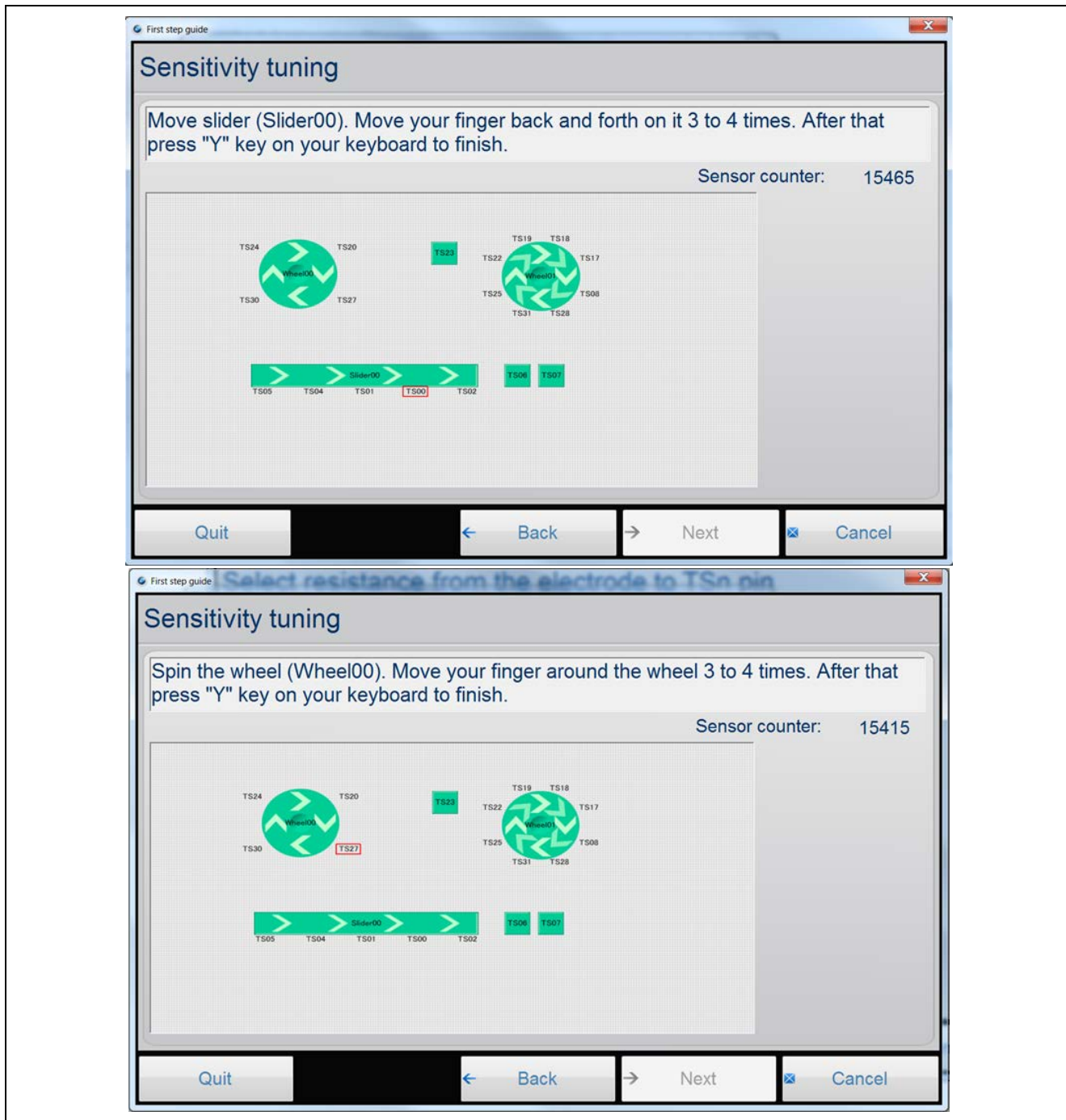

Figure 25. Sensitivity Tuning for Slider and Wheels

Once the tuning process completes, a graphical display for each channel shows capacitances in the touched and untouched state. The display also shows the threshold at which a touch is detected. These thresholds can be manually edited later if the thresholds are not satisfactory. For example, you might want a tighter threshold, knowing there is considerable RF noise in the application environment. In this case, you will want to increase the threshold to avoid noises being identified as touch.

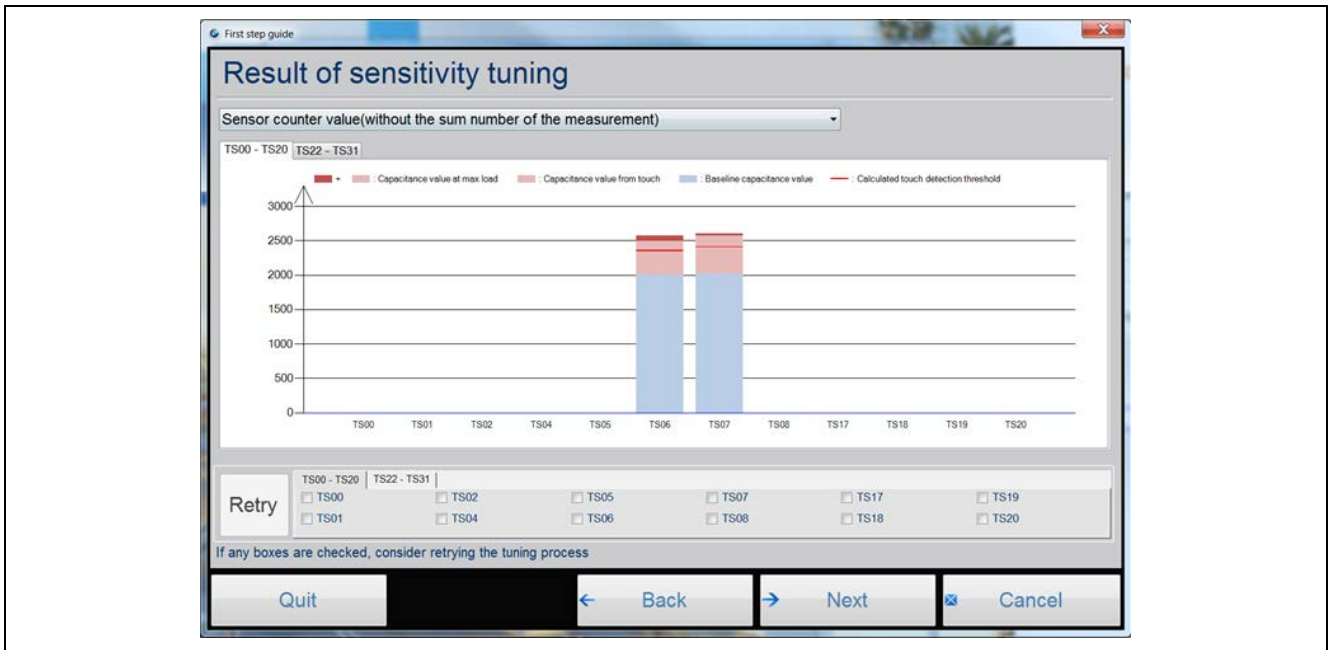

Figure 26. Result of Sensitivity Tuning for Buttons

For slider tuning results, no data is shown for the individual sensor element.

- To view the slider tuning results, change the pull-down option from Sensor Counter Value to Slider/Wheel threshold to view the generated threshold values as shown in the following figure. You can redo the sensitivity tuning for selected channels using the **Retry** option on the same screen such as in a case where you consider a certain channel's threshold to be too low or too high.

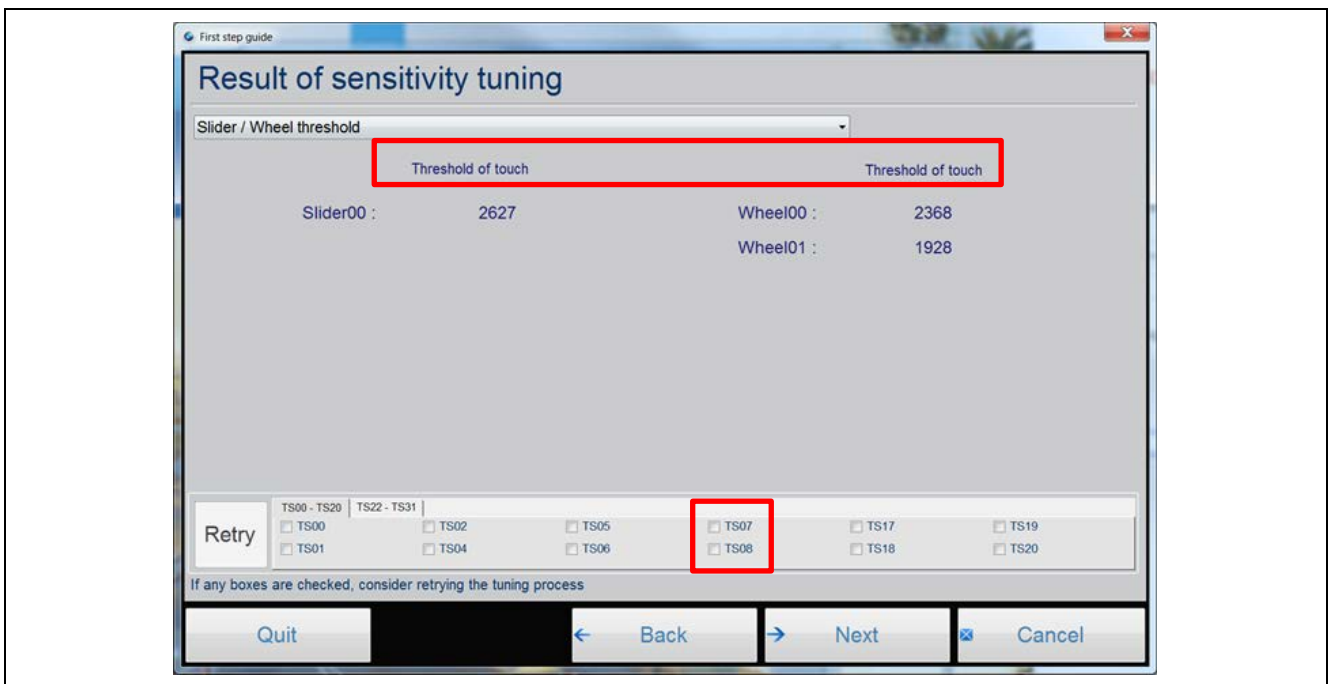

Figure 27. Result of sensitivity tuning for slider/wheel threshold

- The application generates the `captouch_configs` folder with the tuned configuration for all the widgets selected and copies them to the application directory that was initially specified.
- Click **Next**, then click **Finish** to complete Sensitivity Tuning. The generated tuning files can now be used in the application project.

3.5 Monitoring the CTSU Operation after Tuning

Once the basic tuning is complete, and before stopping the debugger, it is possible to view the sensor count values for each sensor in the GUI, for both the touched and untouched states.

After tuning is complete, use the following steps to monitor the CTSU operation:

1. Click **Connection** and choose **Serial Port Connection**.
 - For tuning through UART on Windows 7 and Windows 10, the UART baud rate in the tuning software project needs to use 38,400. The CTW for Synergy automatically connects with the USB Serial Device COM port without.
 - For tuning through USB on Windows 7 and Windows 10, the system supports all the available baud rate settings.
2. The connection is established when the status changes to **Connected** at the bottom left.
3. Once the status changes, select **Capacitive Touch** > **Start Monitor** to begin monitoring CTSU data.
4. Click **Capacitive Touch** > **Status Monitor** to bring up each configured sensor channel one-at-a-time. You can also right-click the display to change the channel being monitored.
5. Touch one of the monitored channels to see the change in data.

Note: The slider window and wheel window are not active when activating the monitor window after tuning before system power is recycled.

4. Using the Tuning Results in Capacitive Touch Applications

To create a functioning Capacitive Touch System, you will need to create the Touch Detection Application and use the tuning result for touch detection.

4.1 Sample Capacitive Touch Applications

There is a group of sample application projects with configurations identical to the AE-CAP1 and DK-S124 tuning projects provided in this application project. You are advised to use the tuning projects provided in this application project with this group of application projects. See the projects for details on the tuning result and the touch application configuration.

Use the software application projects in *Self-Capacitive Touch Software Application Design with Synergy S124 and S3A7 MCUs* alongside the tuning projects shown in the following table.

Table 5. Matching Self-capacitive Tuning and Application Projects

Tuning Projects	Application Projects
Tuning_AE_CAP1_S124_BWS and Tuning_AE_CAP1_S124_BWS_UART	AE_CAP1_S124_BWS_App and AE_CAP1_S124_BWS_App_UART
Tuning_AE_CAP1_S124_ST and Tuning_AE_CAP1_S124_ST_UART	AE_CAP1_S124_ST_App and AE_CAP1_S124_ST_App_UART
Tuning_AE_CAP1_S3A7_ST	AE_CAP1_S3A7_ST_App
Tuning_AE_CAP1_S3A7_BWS	AE_CAP1_S3A7_BWS_App

Note: For S124, either the USB or the UART tuning projects can generate tuning results for either of the corresponding S124 application project. For example, the tuning result from Tuning_AE_CAP1_S124_BWS can be used in AE_CAP1_S124_BWS_App or AE_CAP1_S124_BWS_App_UART. Refer to the *Self-Capacitive Touch Software Application Design with Synergy S124 and S3A7 MCUs* to understand how to establish and configure the self-capacitive touch application projects.

Use the software application projects in *Mutual-Capacitive Touch Software Application Design with Synergy S124 and S3A7 MCUs* with the tuning projects as shown in the following table.

Table 6. Matching Mutual Capacitive Tuning and Application Projects

Tuning Projects	Application Projects
Tuning_AE_CAP1_S124_MT and Tuning_AE_CAP1_S124_MT_UART	AE_CAP1_S124_MT_App and AE_CAP1_S124_MT_App_UART
Tuning_AE_CAP1_S3A7_MT	AE_CAP1_S3A7_MT_App

Note: For S124, either the USB or the UART tuning projects can generate tuning result for either of the corresponding S124 application project. For example, the tuning result from Tuning_A_CAP1_S124_MT can be used in AE_CAP1_S124_MT_App or AE_CAP1_S124_MT_App_UART.

Use the software application project in *CTSU Button Slider on DK-S124* to exercise the tuning result from Tuning_DK_S124.

4.2 General Steps to Import the Tuning Result to an Application Project

This section provides information on importing the tuning result to an application project. You are advised to use the sample application project in conjunction with the tuning results provided in section 3.1.

To import the tuning result in to an application project, use the following steps:

1. In the application project, configure the PCLKB clock to be identical to the corresponding tuning project.
2. Add the Button, Slider, Touch framework and the CTST HAL driver as described in the self-capacitive and mutual capacitive touch application projects. Ensure the **CTST configuration used** property entry is set for the CTSU HAL driver is defined below:
 - A. Mutual Capacitance Mode, set the driver to `g_ctsu_config_mutual`.
 - B. In Self Capacitance Mode, set the driver to `g_ctsu_config_self`.

Following is a list of Synergy Module Guides and Application Projects that describe how to bring in the capacitive touch frameworks as well as the configurations on the CTSU HAL driver:

 - a. *Capacitive Touch Button Framework Module Guide*
 - b. *Capacitive Touch Slider Framework Module Guide*
 - c. Self-Capacitive Touch Software Application Design with Synergy S124 and S3A7 MCUs
 - d. Mutual Capacitive Touch Software Application Design with Synergy S124 and S3A7 MCUs
3. The button and slider/wheel modules have default callback function names: `g_button_framework_user_callback` and `g_slider_framework_user_callback`.
4. You must define these callback functions in their application.
5. You are now ready to build your application project. Use these steps as general guideline in creating a capacitive touch application project and always reference the sample software application project to understand the detailed operation.

5. Sensor Layout Summary

You need to create a layout for the sensor board including all the capacitive touch components and CTSU channels used for each widget. This section provides all the sensor layouts and corresponding CTSU channel numbers for the development kits that we have provided for sample tuning projects.

5.1 Capacitive Touch Sensor layout on AE-CAP1

The following table represents the physical layout on the AE-CAP1 kit. For more details on the related PCB hardware, refer to the individual hardware user manuals. For the entries in each table, the notation before “/” is the silk screen printing on the BWS board.

5.1.1 AE-CAP1-S1 and AE-CAP1-BWS Touch Sensor Layout

The following sensor layout (with corresponding AE-CAP1-BWS silk screen marking) applies to Tuning_AE_CAP1_S124_BWS and Tuning_AE_CAP1_S124_BWS_UART.

Table 7. AE-CAP1-S1 and AE-CAP1-BWS System Sensor Layout

		W-11/TS18			
	W-12/TS19	W-4/TS20	W-10/TS17		
W-5/TS22	W-1/TS24	W-0/TS23	W-3/TS27	W-9/TS8	
	W-6/TS25	W-2/TS30	W-8/TS28		
		W-7/TS31			
				B0/TS6	B1/TS7
S-0/TS5	S-1/TS4	S-2/TS1	S-3/TS0	S-4/TS2	

Clockwise, the inner wheel consists of W-1/TS24, W-4/TS20, W-3/TS27 and W-2/TS30.

Clockwise, the outer wheel consists of W-5/TS22, W-12/TS19, W-11/TS18, W-10/TS17, W-9/TS8, W-8/TS28, W-7/TS31, W-6/TS25.

5.1.2 AE-CAP1-S3 and AE-CAP1-BWS Touch Sensor Layout

The following sensor layout (with corresponding AE-CAP1-BWS silk screen marking) applies to Tuning_AE_CAP1_S3A7_BWS.

Table 8. AE-CAP1-S3 and AE-CAP1-BWS System Sensor Layout

		W-11/TS1			
	W-12/TS4	W-4/TS5	W-10/TS0		
W-5/TS8	W-1/TS10	W-0/TS11	W-3/TS32	W-9/TS21	
	W-6/TS13	W-2/TS12	W-8/TS35		
		W-7/TS34			
				B0/TS31	B1/TS30
S-0/TS27	S-1/TS29	S-2/TS22	S-3/TS26	S-4/TS20	

Clockwise, the inner wheel consists of W-1/TS10, W-4/TS5, W-3/TS32 and W-2/TS12.

Clockwise, the outer wheel consists of W-5/TS8, W-12/TS4, W-11/TS1, W-10/TS0, W-9/TS21, W-8/TS35, W-7/TS34, W-6/TS13.

5.1.3 AE-CAP1-S1 and AE-CAP1-SC Touch Sensor Layout

The following sensor layout (with corresponding AE-CAP1-SC silk screen marking) applies to Tuning_AE_CAP1_S124_ST and Tuning_AE_CAP1_S124_ST_UART.

Table 9. AE-CAP1-S1 and AE-CAP1-SC System Sensor Layout

ST29/TS17	ST28/TS18	ST27/TS19	ST26/TS20	ST25/N.C.	ST24/N.C.
ST23/TS21	ST22/TS22	ST21/TS23	ST20/TS24	ST19/TS25	ST18/TS30
ST17/TS31	ST16/TS28	ST15/TS27	ST14/TS26	ST13/TS16	ST12/TS15
ST11/TS14	ST10/TS13	ST9/TS12	ST8/TS9	ST7/TS8	ST6/TS2
ST5/TS0	ST4/TS1	ST3/TS4	ST2/TS5	ST1/TS6	ST0/TS7

5.1.4 AE-CAP1-S3 and AE-CAP1-SC Touch Sensor Layout

The following sensor layout (with corresponding AE-CAP1-SC silk screen marking) applies to Tuning_AE_CAP1_S3A7_MT.

Table 10. AE-CAP1-S3 and AE-CAP1-SC System Sensor Layout

ST29/TS0	ST28/TS1	ST27/TS4	ST26/TS5	ST25/TS7	ST24/TS6
ST23/TS9	ST22/TS8	ST21/TS11	ST20/TS10	ST19/TS13	ST18/TS12
ST17/TS34	ST16/TS35	ST15/TS32	ST14/TS33	ST13/TS15	ST12/TS14
ST11/TS17	ST10/TS16	ST9/TS19	ST8/TS18	ST7/TS21	ST6/TS20
ST5/TS26	ST4/TS22	ST3/TS29	ST2/TS27	ST1/TS31	ST0/TS30

5.1.5 AE-CAP1-S1 and AE-CAP1-MC

The following sensor layout (with corresponding AE-CAP1-MC silk screen marking) applies to Tuning_AE_CAP1_S124_MT and Tuning_AE_CAP1_S124_MT_UART.

Note: To configure the CTW for Synergy sensor layout, see section 5.1.6 covering AE-CAP1-S3A7 and AE-CAP1-MC sensor tuning methods.

Table 11. AE-CAP1-S1 and AE-CAP1-MC System Sensor layout

MT19/TS0/TS20	MT18/TS0/TS19	MT17/TS0/TS18	MT16/TS0/TS17
MT15/TS2/TS20	MT14/TS2/TS19	MT13/TS2/TS18	MT12/TS2/TS17
MT11/TS8/TS20	MT10/TS8/TS19	MT9/TS8/TS18	MT8/TS8/TS17
MT7/TS9/TS20	MT6/TS9/TS19	MT5/TS9/TS18	MT4/TS9/TS17
MT3/TS12/TS20	MT2/TS12/TS19	MT1/TS12/TS18	MT0/TS12/TS17

5.1.6 AE-CAP1-S3A7 and AE-CAP1-MC

The following sensor layout (with corresponding AE-CAP1-MC silk screen marking) applies to Tuning_AE_CAP1_S3A7_MT.

1. Select **Mutual capacitance method** as seen in the following screen:



2. In the sensor layout canvas, select **Matrix**.
3. Assign TS0, TS1, TS4, TS5 as Receive channels and TS26, TS20, TS21, TS18 and TS19 as Transmit channels.

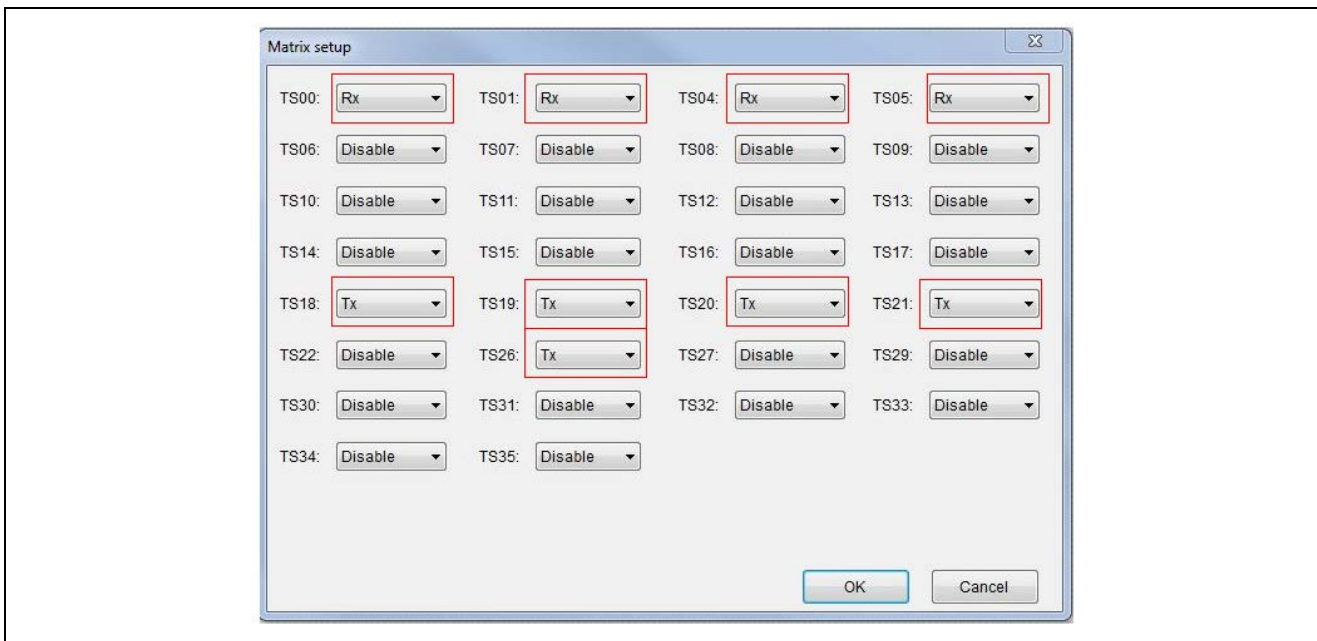

4. When the sensitivity tuning starts, the button to be tuned will be shown in a blinking red box. Then, find the Receive channel and the Transmit channel from the layout. For example, for button Mtx00, the Receive channel is TS00 and the Transmit channel is TS18.

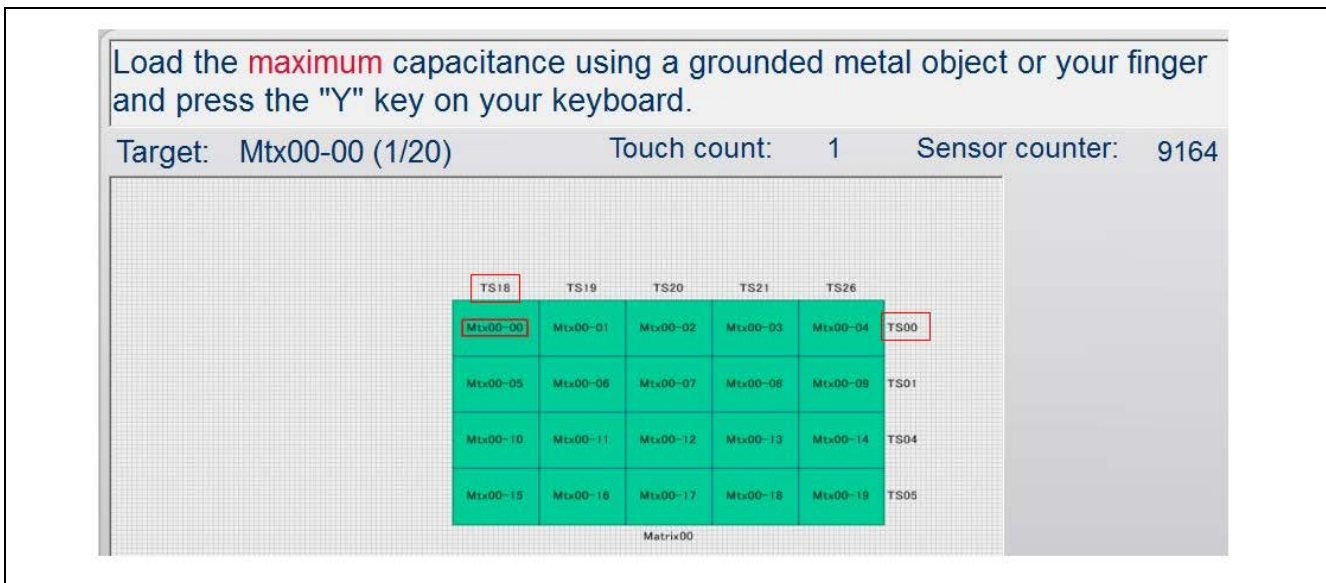

Next, find the matching Receive and Transmit channel from Table 12 to find which button to press on the panel board. From the following table, you can see that button MT4 has the matching Receive channel (TS00) and Transmit channel (TS18). Therefore, during the tuning process, you can press MT4 on the panel board to perform the tuning for Mtx00. When MT4 is pressed, the Sensor counter will drop.

Table 12. AE-CAP1-S3 and AE-CAP1-MC System Sensor Layout

MT19/TS26/TS5	MT18/TS26/TS4	MT17/TS26/TS1	MT16/TS26/TS0
MT15/TS20/TS5	MT14/TS20/TS4	MT13/TS20/TS1	MT12/TS20/TS0
MT11/TS21/TS5	MT10/TS21/TS4	MT9/TS21/TS1	MT8/TS21/TS0
MT7/TS18/TS5	MT6/TS18/TS4	MT5/TS18/TS1	MT4/TS18/TS0
MT3/TS19/TS5	MT2/TS19/TS4	MT1/TS19/TS1	MT0/TS19/TS0

5.2 Capacitive Touch Sensor Layout on SK-S7G2 (v3.2 and later)

The following sensor layout (with corresponding SK-S7G2 silk screen marking) applies to Tuning_SK_S7G2.

Table 13. SK-S7G2 Touch Sensor layout

				Button 1/TS01	Button 2/TS00
TS02	TS04	TS05	TS10	TS11	

5.3 Capacitive Touch Sensor layout on DK-S124

The following sensor layout (with corresponding DK-S124 silk screen marking) applies to Tuning_DK_S124.

Table 14. DK_S124 Touch Sensor layout

				Button 1/TS30	Button 2/TS09
TS31	TS28	TS27	TS02	TS08	

5.4 Capacitive Touch Sensor layout on PK-S5D9

The following sensor layout applies to both Windows 10 and Windows 7 tuning projects (Tuning_PK_S5D9 and Tuning_PK_S5D9_Windows7).

Table 15. PK-S5D9 Touch Sensor layout

				Button 1/TS01	Button 2/TS00
TS02	TS04	TS05	TS10	TS11	

6. Creating a Capacitive Touch Tuning Project for a Custom PCB Board

Use the following guidelines to create a new Capacitive Touch Tuning Project:

- Ensure that your hardware system design followed the application note *Capacitive Touch Hardware Design and Layout Guide* (see reference section).
- Ensure that a functioning BSP pack file exists for the Capacitive Touch System that you will need to tune. This BSP file should have the needed capacitive touch TS pin and TSCAP pin configured.
- Take one of the sample Capacitive Touch Tuning Projects attached with this application project as a reference. It is recommended to use the sample Capacitive Touch Tuning Projects from the same MCU family and the same capacitive touch type to start the development. For example, to create a mutual Capacitive Touch Tuning Project for S3A3, you will want to start with the mutual Capacitive Touch Tuning Project for S3A7 that is included in this application project.
- Import the reference Capacitive Touch Tuning Project to your development workspace.
- Open the Synergy configurator and switch the BSP package to the BSP for the intended new Capacitive Touch System.
- Review the CTSU pin configuration to ensure that all needed CTSU pins are configured. This should be taken care of in the BSP generation process. If any pins are missing or there is misconfiguration on the TSCAP, the BSP package needs to be regenerated.
- From the Synergy configurator, navigate to the **Thread** tab and open the **Property** window for the CTSU driver.
 - Adjust the **Max active channels** to the **maximum capacitive touch channel** in your system. Notice that your system may not use all the touch sensor configured under the CTSU peripheral if your system has multiple capacitive touch sensor boards but you are using one BSP file for all of them.
 - Adjust any of the other configurable parameters under the **Common** section as needed. For example, you may want to consider adjusting the **Startup drift compensation rate** if you want a faster drift compensation than 4 seconds as used by these sample tuning projects.

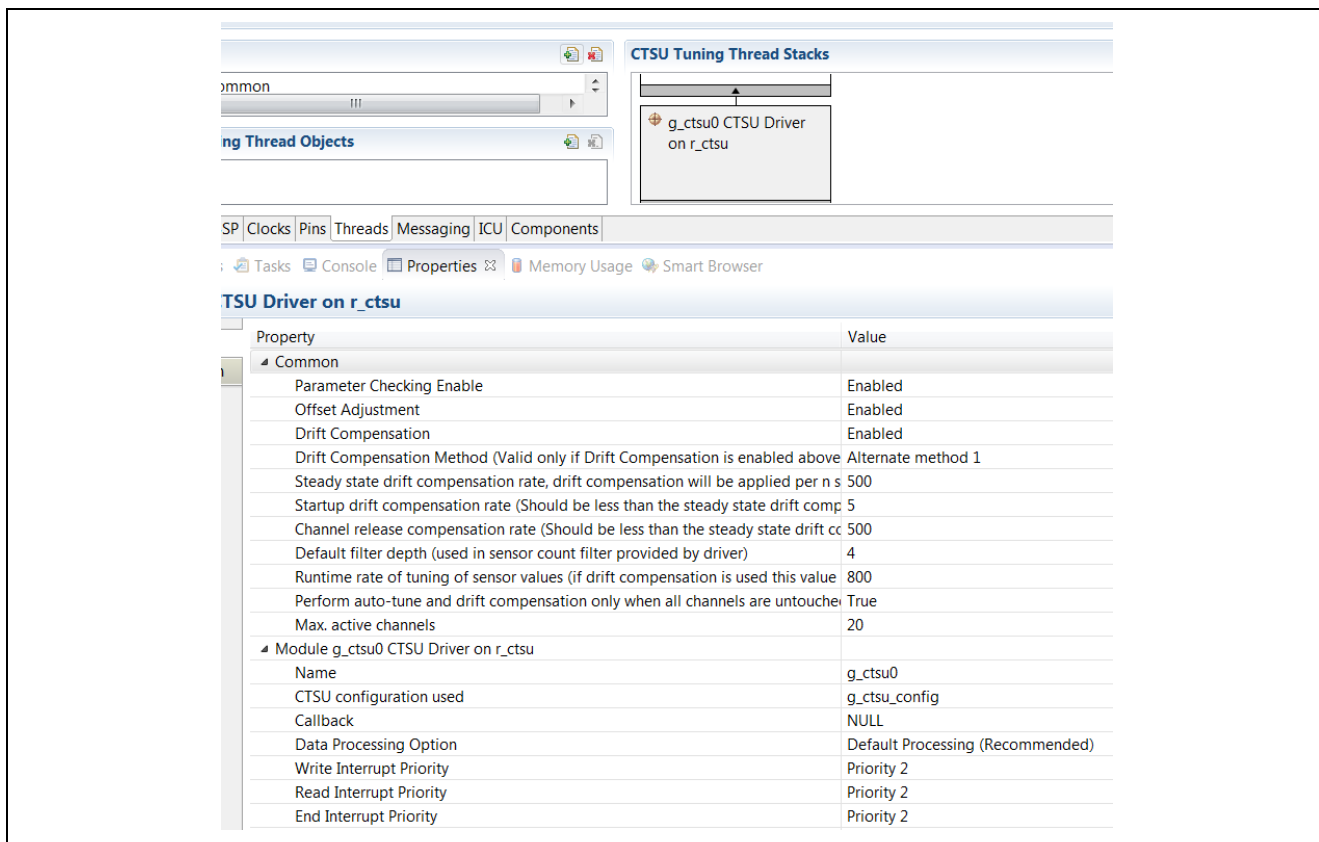

Figure 28. Creating a new Capacitive Touch Tuning Project

- Your project is ready to be tested. Click **Generate Project Content** and proceed to compile and test with the new project.

7. References

- To learn more about the Synergy Software Package, development tools, and utilities visit: renesas.com/synergy/ssp and renesas.com/synergy/tools.
- Download the application note Capacitive Touch Hardware Design and Layout Guide from renesas.com/synergy/docs to learn about the hardware design guidelines for Renesas capacitive touch applications.
- Learn more about:
 - Synergy kits at renesas.com/synergy/kits
 - Synergy Microcontrollers at renesas.com/synergy/microcontrollers
 - Synergy AE-CAP1 Application Projects at renesas.com/synergy/ae-cap1
 - Synergy Software at renesas.com/synergy/software
 - Synergy Solutions at renesas.com/synergy/solutionsgallery

Website and Support

Visit the following vanity URLs to learn about key elements of the Synergy Platform, download components and related documentation, and get support.

Synergy Software	www.renesas.com/synergy/software
Synergy Software Package	www.renesas.com/synergy/ssp
Software add-ons	www.renesas.com/synergy/addons
Software glossary	www.renesas.com/synergy/softwareglossary
Development tools	www.renesas.com/synergy/tools
Synergy Hardware	www.renesas.com/synergy/hardware
Microcontrollers	www.renesas.com/synergy/mcus
MCU glossary	www.renesas.com/synergy/mcuglossary
Parametric search	www.renesas.com/synergy/parametric
Kits	www.renesas.com/synergy/kits
Synergy Solutions Gallery	www.renesas.com/synergy/solutionsgallery
Partner projects	www.renesas.com/synergy/partnerprojects
Application projects	www.renesas.com/synergy/applicationprojects
Self-service support resources:	
Documentation	www.renesas.com/synergy/docs
Knowledgebase	www.renesas.com/synergy/knowledgebase
Forums	www.renesas.com/synergy/forum
Training	www.renesas.com/synergy/training
Videos	www.renesas.com/synergy/videos
Chat and web ticket	www.renesas.com/synergy/resourcelibrary

Revision History

Rev.	Date	Description	
		Page	Summary
1.00	May.23.17	—	First release document
1.01	Sep.07.17	12	Update to Hardware and Software Resources Table
1.02	Nov.09.17	—	Added the <code>module_descriptions</code> folder to the source project
1.03	Nov.21.17	—	Edit and release
1.04	Dec.13.17	—	Added limitation on Slider and Wheel monitoring after tuning
1.05	Apr.30.18	—	Updated for 1.4.0 SSP
1.06	Oct.11.18	—	Updated for 1.5.0 SSP
1.07	Apr.25.19	—	Updated for 1.6.0 SSP
1.08	Oct.02.19	—	Updated for 1.7.0 SSP

Notice

1. Descriptions of circuits, software and other related information in this document are provided only to illustrate the operation of semiconductor products and application examples. You are fully responsible for the incorporation or any other use of the circuits, software, and information in the design of your product or system. Renesas Electronics disclaims any and all liability for any losses and damages incurred by you or third parties arising from the use of these circuits, software, or information.
2. Renesas Electronics hereby expressly disclaims any warranties against and liability for infringement or any other claims involving patents, copyrights, or other intellectual property rights of third parties, by or arising from the use of Renesas Electronics products or technical information described in this document, including but not limited to, the product data, drawings, charts, programs, algorithms, and application examples.
3. No license, express, implied or otherwise, is granted hereby under any patents, copyrights or other intellectual property rights of Renesas Electronics or others.
4. You shall not alter, modify, copy, or reverse engineer any Renesas Electronics product, whether in whole or in part. Renesas Electronics disclaims any and all liability for any losses or damages incurred by you or third parties arising from such alteration, modification, copying or reverse engineering.
5. Renesas Electronics products are classified according to the following two quality grades: "Standard" and "High Quality". The intended applications for each Renesas Electronics product depends on the product's quality grade, as indicated below.

"Standard": Computers; office equipment; communications equipment; test and measurement equipment; audio and visual equipment; home electronic appliances; machine tools; personal electronic equipment; industrial robots; etc.

"High Quality": Transportation equipment (automobiles, trains, ships, etc.); traffic control (traffic lights); large-scale communication equipment; key financial terminal systems; safety control equipment; etc.

Unless expressly designated as a high reliability product or a product for harsh environments in a Renesas Electronics data sheet or other Renesas Electronics document, Renesas Electronics products are not intended or authorized for use in products or systems that may pose a direct threat to human life or bodily injury (artificial life support devices or systems; surgical implantations; etc.), or may cause serious property damage (space system; undersea repeaters; nuclear power control systems; aircraft control systems; key plant systems; military equipment; etc.). Renesas Electronics disclaims any and all liability for any damages or losses incurred by you or any third parties arising from the use of any Renesas Electronics product that is inconsistent with any Renesas Electronics data sheet, user's manual or other Renesas Electronics document.
6. When using Renesas Electronics products, refer to the latest product information (data sheets, user's manuals, application notes, "General Notes for Handling and Using Semiconductor Devices" in the reliability handbook, etc.), and ensure that usage conditions are within the ranges specified by Renesas Electronics with respect to maximum ratings, operating power supply voltage range, heat dissipation characteristics, installation, etc. Renesas Electronics disclaims any and all liability for any malfunctions, failure or accident arising out of the use of Renesas Electronics products outside of such specified ranges.
7. Although Renesas Electronics endeavors to improve the quality and reliability of Renesas Electronics products, semiconductor products have specific characteristics, such as the occurrence of failure at a certain rate and malfunctions under certain use conditions. Unless designated as a high reliability product or a product for harsh environments in a Renesas Electronics data sheet or other Renesas Electronics document, Renesas Electronics products are not subject to radiation resistance design. You are responsible for implementing safety measures to guard against the possibility of bodily injury, injury or damage caused by fire, and/or danger to the public in the event of a failure or malfunction of Renesas Electronics products, such as safety design for hardware and software, including but not limited to redundancy, fire control and malfunction prevention, appropriate treatment for aging degradation or any other appropriate measures. Because the evaluation of microcomputer software alone is very difficult and impractical, you are responsible for evaluating the safety of the final products or systems manufactured by you.
8. Please contact a Renesas Electronics sales office for details as to environmental matters such as the environmental compatibility of each Renesas Electronics product. You are responsible for carefully and sufficiently investigating applicable laws and regulations that regulate the inclusion or use of controlled substances, including without limitation, the EU RoHS Directive, and using Renesas Electronics products in compliance with all these applicable laws and regulations. Renesas Electronics disclaims any and all liability for damages or losses occurring as a result of your noncompliance with applicable laws and regulations.
9. Renesas Electronics products and technologies shall not be used for or incorporated into any products or systems whose manufacture, use, or sale is prohibited under any applicable domestic or foreign laws or regulations. You shall comply with any applicable export control laws and regulations promulgated and administered by the governments of any countries asserting jurisdiction over the parties or transactions.
10. It is the responsibility of the buyer or distributor of Renesas Electronics products, or any other party who distributes, disposes of, or otherwise sells or transfers the product to a third party, to notify such third party in advance of the contents and conditions set forth in this document.
11. This document shall not be reprinted, reproduced or duplicated in any form, in whole or in part, without prior written consent of Renesas Electronics.
12. Please contact a Renesas Electronics sales office if you have any questions regarding the information contained in this document or Renesas Electronics products.

(Note1) "Renesas Electronics" as used in this document means Renesas Electronics Corporation and also includes its directly or indirectly controlled subsidiaries.

(Note2) "Renesas Electronics product(s)" means any product developed or manufactured by or for Renesas Electronics.

(Rev.4.0-1 November 2017)

Corporate Headquarters

TOYOSU FORESIA, 3-2-24 Toyosu,
Koto-ku, Tokyo 135-0061, Japan
www.renesas.com

Trademarks

Renesas and the Renesas logo are trademarks of Renesas Electronics Corporation. All trademarks and registered trademarks are the property of their respective owners.

Contact information

For further information on a product, technology, the most up-to-date version of a document, or your nearest sales office, please visit:
www.renesas.com/contact/.