

# Sensorless vector control for permanent magnetic synchronous motor - 1shunt current detection

For Renesas Flexible Motor Control Series

---

## Abstract

This application note describes the sample program for a permanent magnetic synchronous motor drive with sensorless vector control based on Renesas microcontroller. This application note also describes how to use the motor control development support tool, 'Renesas Motor Workbench'.

The targeted software for this application note is only to be used as reference purposes only and Renesas Electronics Corporation does not guarantee the operations. Please use this after carrying out a thorough evaluation in a suitable environment.

## Operation checking device

Operations of the target software of this application note are checked by using the following device.

- RA6T2 (R7FA6T2BD3CFP)
- RA6T3 (R7FA6T3BB3CFM)
- RA4T1 (R7FA4T1BB3CFM)
- RA8T1 (R7FA8T1AHECBD)

## Target software

The following shows the target software for this application:

- RA6T2\_MCILV1\_SPM\_LESS\_FOC\_1SHUNT\_E2S\_V110
- RA6T3\_MCILV1\_SPM\_LESS\_FOC\_1SHUNT\_E2S\_V100
- RA4T1\_MCILV1\_SPM\_LESS\_FOC\_1SHUNT\_E2S\_V100
- RA8T1\_MCILV1\_SPM\_LESS\_FOC\_1SHUNT\_E2S\_V100

## Contents

1. Overview.....	4
2. Development environment.....	4
2.1 Test environments.....	4
2.2 Hardware configuration.....	5
2.2.1 Hardware configuration diagram.....	5
2.2.2 Hardware modification details.....	6
2.2.3 Board User interface.....	7
2.2.4 Peripheral functions.....	8
2.3 Software configuration.....	36
2.3.1 Software file configuration.....	36
2.3.2 Module configuration.....	38
2.4 Software specifications.....	39
2.5 Interrupt Priority.....	40
3. Descriptions of the control program.....	41
3.1 Contents of control.....	41
3.1.1 Motor start/stop.....	41
3.1.2 A/D Converter.....	41
3.1.3 Modulation (current control module).....	42
3.1.4 State transition.....	43
3.1.5 Start-up method.....	44
3.1.6 System protection function.....	45
3.1.7 The method to measure phase currents with an 1shunt resistance.....	46
3.1.8 AD triggers.....	49
3.2 Function specifications of sensorless vector control software.....	50
3.3 Contents of control.....	57
3.3.1 Configuration Options.....	57
3.3.2 Configuration Options for included modules.....	57
3.4 Control flowcharts.....	66
3.4.1 Main process.....	66
3.4.2 Current Control Period Interrupt (Carrier synchronized Interrupt) Process.....	67
3.4.3 Speed Control Period Interrupt Process.....	68
3.4.4 Over Current Detection Interrupt Process.....	69
4. Evaluation environment explanation.....	70
4.1 Importing the Demo Project.....	70
4.2 Building and Debugging.....	71
4.3 Motor Demonstration Project Overview.....	72
4.3.1 Quick Start.....	72
4.4 Motor Control Development Support Tool 'Renesas Motor Workbench'.....	73

---

4.4.1	Overview.....	73
4.4.2	Easy function operation example.....	74
4.4.3	List of variables for Analyzer function.....	76
4.4.4	Operation Example for Analyzer.....	77
4.4.5	Tuner function.....	78
4.4.6	Example of changing communication speed.....	79
4.4.7	How to use the built-in communication library.....	79
5.	Reference Documents.....	83
	Revision History.....	84

## 1. Overview

This application note explains how to implement the sensorless vector control software that drives a permanent magnetic synchronous motor (PMSM) using the RA series microcontroller and how to use the motor control development support tool, 'Renesas Motor Workbench'.

Note that this software uses the algorithm described in the application note 'Sensorless vector control for permanent magnet synchronous motor (Algorithm)' (R01AN3786), so please refer to that for the details of the algorithm.

## 2. Development environment

### 2.1 Test environments

Table 2-1 and Table 2-2 show development environment of the software explained in this application note.

**Table 2-1 Hardware Development Environment**

Category	Product used
Microcontroller / CPU board product type	RA6T2 (R7FA6T2BD3CFP) / RTK0EMA270C00000BJ RA4T1 (R7FA4T1BB3CFM) / RTK0EMA430C00000BJ RA6T3(R7FA6T3BB3CFM) / RTK0EMA330C00000BJ RA8T1(R7FA8T1AHECBD) / RTK0EMA5K0C00000BJ
Inverter board	MCI-LV-1 / RTK0EM0000S04020BJ
Motor	R42BLD30L3
Sensor	None

**Table 2-2 Software Development Environment**

e <sup>2</sup> studio version	FSP version	Toolchain version
e <sup>2</sup> studio : 2023-10	V5.1.0	GCC ARM Embedded : 10.3.1.20210824(RA6T2,RA6T3,RA4T1) 13.2.1.arm-13-7 (RA8T1)

For purchase and technical support, contact Sales representatives and dealers of Renesas Electronics Corporation.

## 2.2 Hardware configuration

### 2.2.1 Hardware configuration diagram

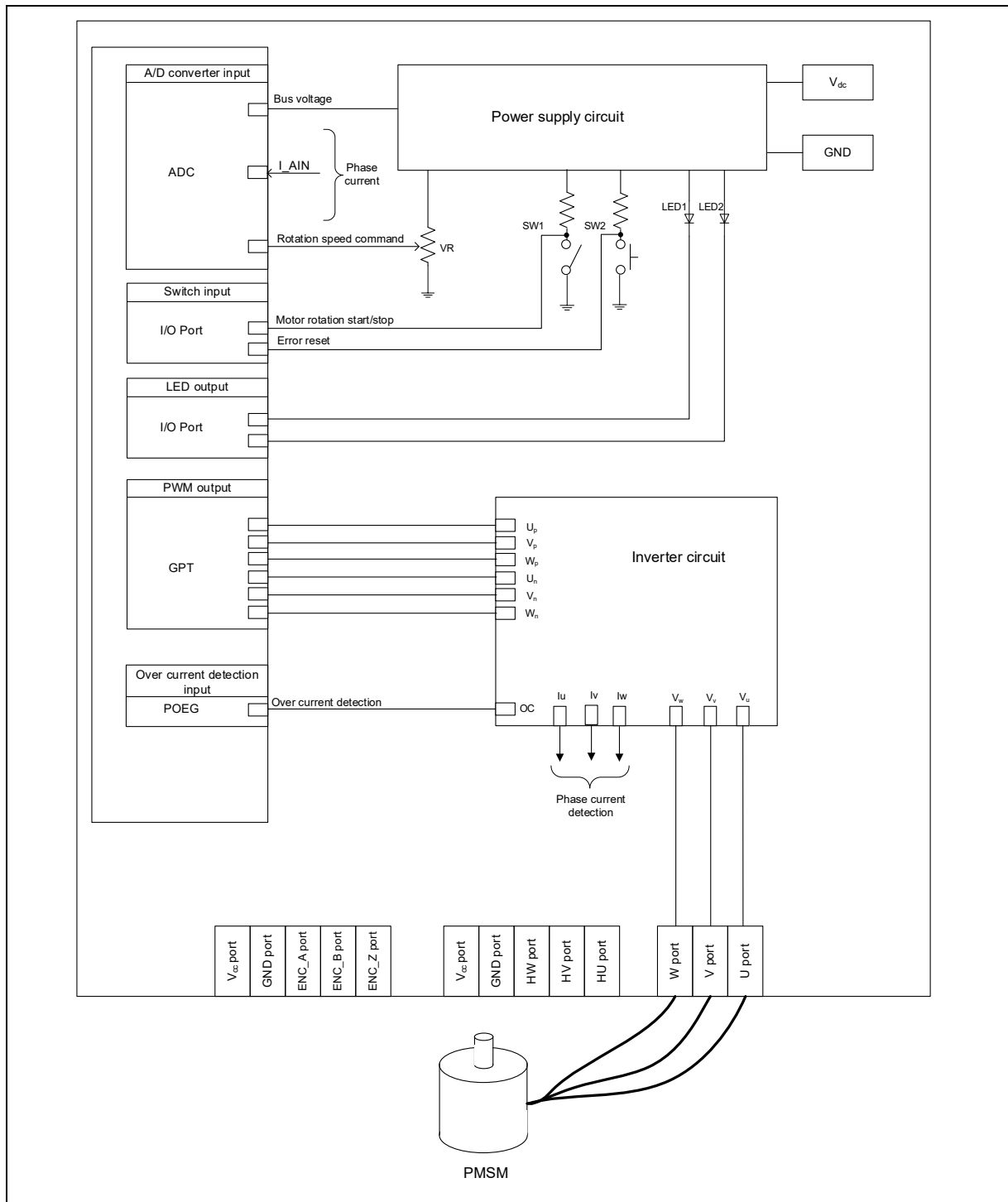

Figure 2-1 Hardware Configuration Diagram

### 2.2.2 Hardware modification details

Jumper pins need to be changed to use this system.

Please change the MCI-LV-1 connection of a jumper (JP8 and JP11) to connect 2-3 pins from 1-2 pins.

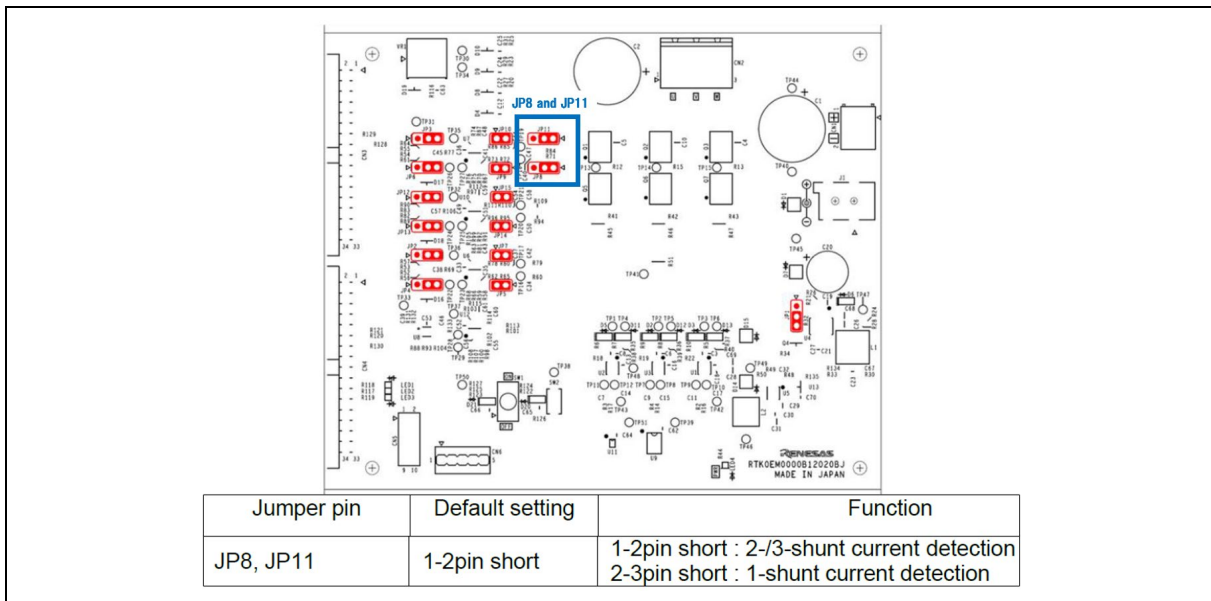

Figure 2-2 Change the connection of a jumper

### 2.2.3 Board User interface

Table 2-3 is lists of user interfaces of this system.

**Table 2-3 Board user interface**

Item	Interface component	Function
Rotation position/speed	Volume (VR1)	Inputs the rotation position/speed command value (analog value).
START/STOP	Toggle switch (SW1)	Instructs start or stop of motor rotation.
ERROR RESET	Push switch (SW2)	Instructs recovery from an error state
LED1	Orange LED	On: The motor is rotating. Off: The motor is stopped.
LED2	Orange LED	On: An error was detected. Off: The system is operating normally.
LED3	Orange LED	Not used in this system
RESET	Push switch (RESET1)	System reset

List of port interfaces of this system is given in **Table 2-4**.

**Table 2-4 Port interfaces**

Function	RA6T2	RA4T1	RA6T3	RA8T1
Inverter bus voltage measurement	PA06 / AN006	P004 / AN004	P004 / AN004	P008 / AN008
For rotation speed command value input (analog value)	PB00 / AN008	P005 / AN005	P005 / AN005	P014 / AN007
START/STOP toggle switch (SW1)	PD04	P304	P304	PA15
ERROR RESET push switch (SW2)	PD07	P200	P200	PA13
LED1 ON/OFF control	PD01	P113	P113	PA12
LED2 ON/OFF control	PD02	P106	P106	PA14
Phase current measurement with 1shunt resistance	PA04 / AN004	P000 / AN000	P000 / AN000	PA04 / AN000
PWM output ( $U_p$ )	PB04 / GTIOC4A	P409 / GTIOC1A	P409 / GTIOC1A	P115 / GTIOC5A
PWM output ( $V_p$ )	PB06 / GTIOC5A	P103 / GTIOC2A	P103 / GTIOC2A	P113 / GTIOC2A
PWM output ( $W_p$ )	PB08 / GTIOC6A	P111 / GTIOC3A	P111 / GTIOC3A	P300 / GTIOC3A
PWM output ( $U_n$ )	PB05 / GTIOC4B	P408 / GTIOC1B	P408 / GTIOC1B	P609 / GTIOC5B
PWM output ( $V_n$ )	PB07 / GTIOC5B	P102 / GTIOC2B	P102 / GTIOC2B	P114 / GTIOC2B
PWM output ( $W_n$ )	PB09 / GTIOC6B	P112 / GTIOC3B	P112 / GTIOC3B	P112 / GTIOC3B
PWM emergency stop input at the time of overcurrent detection	PC13 / GTETRGD	P104 / GTETRGB	P104 / GTETRGB	P613 / GTETRGA

### 2.2.4 Peripheral functions

List of the peripheral functions used in this system is given in Table 2-5.

**Table 2-5 List of the Peripheral Functions**

Peripheral	Purpose	RA6T2	RA4T1	RA6T3	RA8T1
12-bit A/D Converter	Phase current measurement with 1shunt resistance	AN004	AN000	AN000	AN000
	Inverter bus voltage measurement	AN006	AN004	AN004	AN008
	For rotation speed command value input (analog value)	AN008	AN005	AN005	AN007
AGT	Speed control interval timer	AGT0	AGT0	AGT0	AGT0
GPT	U phase PWM output	CH4	CN1	CN1	CN5
	V phase PWM output	CH5	CN2	CN2	CN2
	W phase PWM output	CH6	CN3	CN3	CN3
POEG	PWM emergency stop input at the time of overcurrent detection	Group D	Group B	Group B	Group A

#### 2.2.4.1 RA6T2

##### (1). 12-bit A/D Converter (ADC)

Phase current (with an 1shunt resistance), inverter bus voltage (Vdc) and rotation speed command (VR1) are measured in "Single scan mode" (use a hardware trigger).

Detection of the phase current uses FIFO function.

A/D conversion is implemented to be synchronized with carrier synchronized interrupt by using direct link function to GPT.

##### (2). Low Power Asynchronous General-Purpose Timer (AGT)

The AGT is used as 1 [ms] interval timer.

##### (3). General PWM Timer (GPT)

On the channel 4, 5, and 6, output with dead time is performed by using the Triangle-wave PWM mode 3.

##### (4). Port Output Enable for GPT (POEG)

The port executing PWM output are set to high impedance state when an overcurrent is detected (when a low level of the GTETRGD port is detected) .

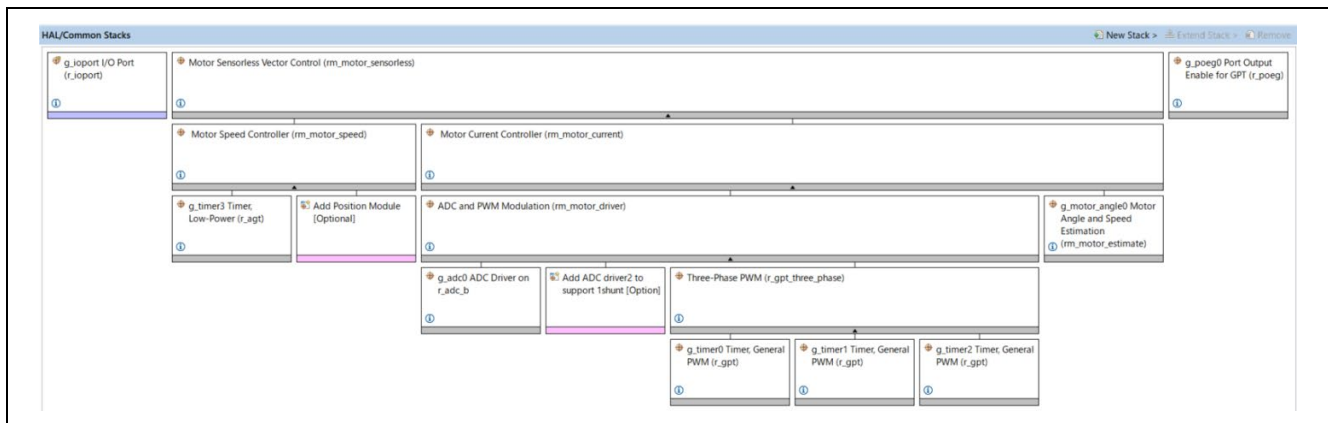

Figure 2-3 Overall FSP Stacks diagram



g_adc0 ADC Driver on r_adc_b		
Settings	Property	Value
API Info	▼ Common	
	Parameter Checking	Default (BSP)
	▼ Module g_adc0 ADC Driver on r_adc_b	
	▼ General	
	▼ Mode	
	ADC 0	Single Scan
	ADC 1	Single Scan
	> ADC Successive Approximation Time	
	> Synchronous Operation	
	> Calibration	
	> Sampling State Table	
	Name	g_adc0
	> Clock Configuration	
	▼ Interrupts	
	> Limiter Clip Priority	
	> Conversion Error Priority	
	> Overflow Priority	
	> Calibration End Priority	
	> Scan End Priority	
	> FIFO Priorities	
	Callback	NULL
	> Sample and Hold	
	> User Offset Table	
	> User Gain Table	
	> Limiter Clipping	

Figure 2-4 FSP Configuration of ADC Driver [1/3]

g_adc0 ADC Driver on r_adc_b		
Settings	Property	Value
API Info	Virtual Channel 2	
	Scan Group	Scan Group 0
	Channel Select	AN004
	Sampling State Table ID	Sampling State Entry 0
	Channel Gain Table	Disabled
	Channel Offset Table	Disabled
	Add/Average Mode	Disabled
	Add/Average Count	1-time conversion (Normal Conversion)
	Limit Clip Table Id	Disabled
	Conversion Resolution Format Select	12-bit Data Format
	Virtual Channel 3	
	Scan Group	Scan Group 1
	Channel Select	AN006
	Sampling State Table ID	Sampling State Entry 0
	Channel Gain Table	Disabled
	Channel Offset Table	Disabled
	Add/Average Mode	Disabled
	Add/Average Count	1-time conversion (Normal Conversion)
	Limit Clip Table Id	Disabled
	Conversion Resolution Format Select	12-bit Data Format
	Virtual Channel 4	
	Scan Group	Scan Group 1
	Channel Select	AN008
	Sampling State Table ID	Sampling State Entry 0
	Channel Gain Table	Disabled
	Channel Offset Table	Disabled
	Add/Average Mode	Disabled
	Add/Average Count	1-time conversion (Normal Conversion)
	Limit Clip Table Id	Disabled
	Conversion Resolution Format Select	12-bit Data Format
	Virtual Channel 5	
	Virtual Channel 6	

Figure 2-5 FSP Configuration of ADC Driver [2/3]

g_adc0 ADC Driver on r_adc_b		
Settings	Property	Value
API Info	<ul style="list-style-type: none"> <li>▼ Scan Groups</li> <li> <ul style="list-style-type: none"> <li>▼ Scan Group 0</li> <li> <ul style="list-style-type: none"> <li>&gt; Self Diagnosis</li> <li>&gt; External Trigger Enable</li> <li>&gt; ELC Trigger Enable</li> <li>▼ GPT Trigger Enable</li> <li>GPT Channel 0 Request A <input type="checkbox"/></li> <li>GPT Channel 1 Request A <input type="checkbox"/></li> <li>GPT Channel 2 Request A <input type="checkbox"/></li> <li>GPT Channel 3 Request A <input type="checkbox"/></li> <li>GPT Channel 4 Request A <input checked="" type="checkbox"/></li> <li>GPT Channel 5 Request A <input type="checkbox"/></li> <li>GPT Channel 6 Request A <input type="checkbox"/></li> <li>GPT Channel 7 Request A <input type="checkbox"/></li> <li>GPT Channel 8 Request A <input type="checkbox"/></li> <li>GPT Channel 9 Request A <input type="checkbox"/></li> <li>GPT Channel 0 Request B <input type="checkbox"/></li> <li>GPT Channel 1 Request B <input type="checkbox"/></li> <li>GPT Channel 2 Request B <input type="checkbox"/></li> <li>GPT Channel 3 Request B <input type="checkbox"/></li> <li>GPT Channel 4 Request B <input checked="" type="checkbox"/></li> <li>GPT Channel 5 Request B <input type="checkbox"/></li> <li>GPT Channel 6 Request B <input type="checkbox"/></li> <li>GPT Channel 7 Request B <input type="checkbox"/></li> <li>GPT Channel 8 Request B <input type="checkbox"/></li> <li>GPT Channel 9 Request B <input type="checkbox"/></li> <li>Enable <input type="checkbox"/></li> <li>Converter Selection <input type="text" value="ADC 0"/></li> <li>Start Trigger Delay <input type="text" value="0"/></li> <li>Scan End Interrupt Enable <input type="checkbox"/></li> <li>Limit Clip Interrupt Enable <input type="checkbox"/></li> <li>FIFO Enable <input type="checkbox"/></li> <li>FIFO Interrupt Enable <input type="checkbox"/></li> <li>FIFO Interrupt Generation Level <input type="text" value="0"/></li> <li>▼ Scan Group 1</li> <li> <ul style="list-style-type: none"> <li>&gt; Self Diagnosis</li> <li>&gt; External Trigger Enable</li> <li>&gt; ELC Trigger Enable</li> <li>&gt; GPT Trigger Enable</li> <li>Enable <input type="checkbox"/></li> <li>Converter Selection <input type="text" value="ADC 1"/></li> <li>Start Trigger Delay <input type="text" value="0"/></li> <li>Scan End Interrupt Enable <input type="checkbox"/></li> <li>Limit Clip Interrupt Enable <input type="checkbox"/></li> <li>FIFO Enable <input type="checkbox"/></li> <li>FIFO Interrupt Enable <input type="checkbox"/></li> <li>FIFO Interrupt Generation Level <input type="text" value="0"/></li> <li>&gt; Scan Group 2</li> <li>&gt; Scan Group 3</li> </ul> </li> </ul> </li> </ul> </li> </ul>	

Figure 2-6 FSP Configuration of ADC Driver [3/3]

g_timer3 Timer, Low-Power (r_agt)		
Settings	Property	Value
API Info	▼ Common	
	Parameter Checking	Default (BSP)
	Pin Output Support	Disabled
	Pin Input Support	Disabled
	▼ Module g_timer3 Timer, Low-Power (r_agt)	
	▼ General	
	Name	g_timer3
	Channel	0
	Mode	🔒 Periodic
	Period	60000
	Period Unit	Raw Counts
	Count Source	PCLKB
	> Output	
	> Input	
	▼ Interrupts	
	Callback	🔒 rm_motor_speed_cyclic
	Underflow Interrupt Priority	Priority 10

Figure 2-7 FSP Configuration of AGT Driver

g_timer0 Timer, General PWM (r_gpt)		
Settings	Property	Value
API Info	▼ Common	
	Parameter Checking	Default (BSP)
	Pin Output Support	Enabled with Extra Features
	Write Protect Enable	Disabled
	Clock Source	PCLKD
	▼ Module g_timer0 Timer, General PWM (r_gpt)	
	▼ General	
	Name	g_timer0
	Channel	4
	Mode	Triangle-Wave Asymmetric PWM (Mode 3)
	Period	100
	Period Unit	Microseconds
	▼ Output	
	> Custom Waveform	
	Duty Cycle Percent (only applicable in PWM mode)	50
	GTIOCA Output Enabled	True
	GTIOCA Stop Level	Pin Level Low
	GTIOCB Output Enabled	True
	GTIOCB Stop Level	Pin Level High
	> Input	
	▼ Interrupts	
	Callback	rm_motor_driver_1shunt_cyclic
	Overflow/Crest Interrupt Priority	Priority 5
	Capture A Interrupt Priority	Disabled
	Capture B Interrupt Priority	Disabled
	Underflow/Trough Interrupt Priority	Disabled
	▼ Extra Features	
	▼ Output Disable	
	> Output Disable POEG Trigger	
	POEG Link	POEG Channel 3
	GTIOCA Disable Setting	Set Hi Z
	GTIOCB Disable Setting	Set Hi Z
	▼ ADC Trigger	
	▼ Start Event Trigger (GPTE/GPTEH only)	
	Trigger Event A/D Converter Start Request A Durin	<input checked="" type="checkbox"/>
	Trigger Event A/D Converter Start Request A Durin	<input type="checkbox"/>
	Trigger Event A/D Converter Start Request B Durin	<input checked="" type="checkbox"/>
	Trigger Event A/D Converter Start Request B Durin	<input type="checkbox"/>
	> Dead Time	
	> ADC Trigger (GPTE/GPTEH only)	
	> Interrupt Skipping (GPTE/GPTEH only)	
	Extra Features	Enabled
	▼ Pins	
	GTIOC4A	PB04
	GTIOC4B	PB05

Figure 2-8 FSP Configuration of GPT Driver



### 2.2.4.2 RA4T1

#### (1). 12-bit A/D Converter (ADC12)

Phase current (with an 1shunt resistance), inverter bus voltage (Vdc) and rotation speed command (VR1) are measured in "Single scan mode" (use a hardware trigger).

Detection of the phase current uses FIFO function.

A/D conversion is implemented to be synchronized with carrier synchronized interrupt by using direct link function to GPT.

#### (2). Low Power Asynchronous General-Purpose Timer (AGT)

The AGT is used as 1 [ms] interval timer.

#### (3). General PWM Timer (GPT)

On the channel 1, 2, and 3, output with dead time is performed by using the Triangle-wave PWM mode 3. .

#### (4). Port Output Enable for GPT (POEG)

The port executing PWM output are set to high impedance state when an overcurrent is detected (when a low level of the GTETRGB port is detected) .

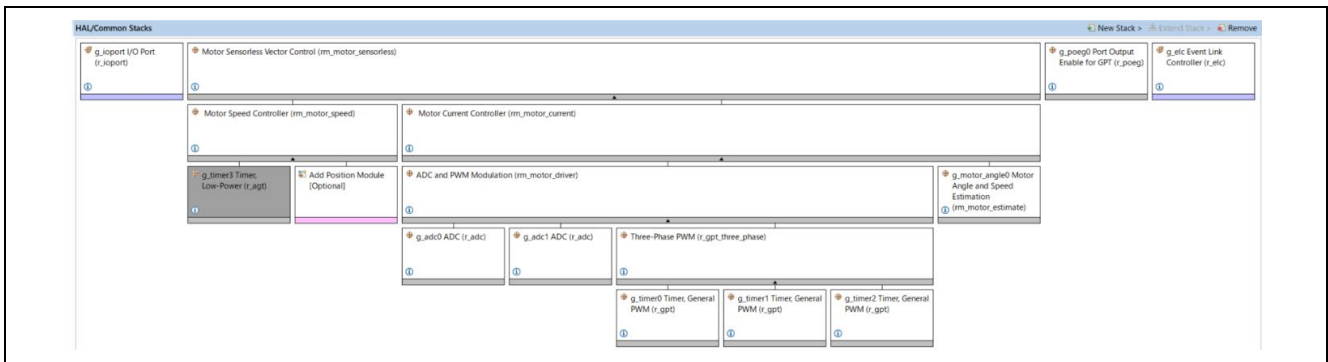

Figure 2-10 Overall FSP Stacks diagram

g_adc0 ADC (r_adc)		
Settings	Property	Value
API Info	<ul style="list-style-type: none"> <li>▼ Common</li> <li>Parameter Checking</li> <li>▼ Module g_adc0 ADC (r_adc)</li> <li>▼ General</li> <li>Name</li> <li>Unit</li> <li>Resolution</li> <li>Alignment</li> <li>Clear after read</li> <li>Mode</li> <li>Double-trigger</li> <li>&gt; Input</li> <li>▼ Interrupts</li> <li>Normal/Group A Trigger</li> <li>Group B Trigger</li> <li>Group Priority (Valid only in Group Scan Mode)</li> <li>Callback</li> <li>Scan End Interrupt Priority</li> <li>Scan End Group B Interrupt Priority</li> <li>Window Compare A Interrupt Priority</li> <li>Window Compare B Interrupt Priority</li> <li>&gt; Extra</li> </ul>	<ul style="list-style-type: none"> <li>Default (BSP)</li> <li></li> <li></li> <li>g_adc0</li> <li>0</li> <li>🔒 12-Bit</li> <li>🔒 Right</li> <li>On</li> <li>Single Scan</li> <li>Enabled (extended mode)</li> <li></li> <li></li> <li>GPT1 AD TRIG A (A/D converter start request A)</li> <li>GPT1 AD TRIG B (A/D converter start request B)</li> <li>Group A cannot interrupt Group B</li> <li>NULL</li> <li>Disabled</li> <li>Disabled</li> <li>Disabled</li> <li>Disabled</li> <li></li> </ul>

Figure 2-11 FSP Configuration of ADC Driver [1/4]



g_adc0 ADC (r_adc)																																																																
Settings	Property	Value																																																														
API Info	<ul style="list-style-type: none"> <li>▼ Module g_adc0 ADC (r_adc)               <ul style="list-style-type: none"> <li>&gt; General</li> <li>▼ Input                   <ul style="list-style-type: none"> <li>▼ Channel Scan Mask (channel availability varies by MCU)                       <table border="1" style="width: 100%; border-collapse: collapse;"> <thead> <tr> <th>Channel</th> <th>Value</th> </tr> </thead> <tbody> <tr><td>Channel 0</td><td><input checked="" type="checkbox"/></td></tr> <tr><td>Channel 1</td><td><input type="checkbox"/></td></tr> <tr><td>Channel 2</td><td><input type="checkbox"/></td></tr> <tr><td>Channel 3</td><td><input type="checkbox"/></td></tr> <tr><td>Channel 4</td><td><input type="checkbox"/></td></tr> <tr><td>Channel 5</td><td><input type="checkbox"/></td></tr> <tr><td>Channel 6</td><td><input type="checkbox"/></td></tr> <tr><td>Channel 7</td><td><input type="checkbox"/></td></tr> <tr><td>Channel 8</td><td><input type="checkbox"/></td></tr> <tr><td>Channel 9</td><td><input type="checkbox"/></td></tr> <tr><td>Channel 10</td><td><input type="checkbox"/></td></tr> <tr><td>Channel 11</td><td><input type="checkbox"/></td></tr> <tr><td>Channel 12</td><td><input type="checkbox"/></td></tr> <tr><td>Channel 13</td><td><input type="checkbox"/></td></tr> <tr><td>Channel 14</td><td><input type="checkbox"/></td></tr> <tr><td>Channel 15</td><td><input type="checkbox"/></td></tr> <tr><td>Channel 16</td><td><input type="checkbox"/></td></tr> <tr><td>Channel 17</td><td><input type="checkbox"/></td></tr> <tr><td>Channel 18</td><td><input type="checkbox"/></td></tr> <tr><td>Channel 19</td><td><input type="checkbox"/></td></tr> <tr><td>Channel 20</td><td><input type="checkbox"/></td></tr> <tr><td>Channel 21</td><td><input type="checkbox"/></td></tr> <tr><td>Channel 22</td><td><input type="checkbox"/></td></tr> <tr><td>Channel 23</td><td><input type="checkbox"/></td></tr> <tr><td>Channel 24</td><td><input type="checkbox"/></td></tr> <tr><td>Channel 25</td><td><input type="checkbox"/></td></tr> <tr><td>Channel 26</td><td><input type="checkbox"/></td></tr> <tr><td>Channel 27</td><td><input type="checkbox"/></td></tr> <tr><td>Temperature Sensor</td><td><input type="checkbox"/></td></tr> <tr><td>Voltage Sensor</td><td><input type="checkbox"/></td></tr> </tbody> </table> </li> <li>&gt; Group B Scan Mask (channel availability varies by MCU)</li> <li>&gt; Addition/Averaging Mask (channel availability varies by MCU and unit)</li> <li>&gt; Sample and Hold</li> <li>&gt; Window Compare</li> <li>Add/Average Count <span style="float: right;">🔒 Disabled</span></li> <li>Reference Voltage control <span style="float: right;">🔒 VREFH0/VREFH</span></li> <li>&gt; Interrupts</li> <li>&gt; Extra</li> </ul> </li> </ul> </li></ul>	Channel	Value	Channel 0	<input checked="" type="checkbox"/>	Channel 1	<input type="checkbox"/>	Channel 2	<input type="checkbox"/>	Channel 3	<input type="checkbox"/>	Channel 4	<input type="checkbox"/>	Channel 5	<input type="checkbox"/>	Channel 6	<input type="checkbox"/>	Channel 7	<input type="checkbox"/>	Channel 8	<input type="checkbox"/>	Channel 9	<input type="checkbox"/>	Channel 10	<input type="checkbox"/>	Channel 11	<input type="checkbox"/>	Channel 12	<input type="checkbox"/>	Channel 13	<input type="checkbox"/>	Channel 14	<input type="checkbox"/>	Channel 15	<input type="checkbox"/>	Channel 16	<input type="checkbox"/>	Channel 17	<input type="checkbox"/>	Channel 18	<input type="checkbox"/>	Channel 19	<input type="checkbox"/>	Channel 20	<input type="checkbox"/>	Channel 21	<input type="checkbox"/>	Channel 22	<input type="checkbox"/>	Channel 23	<input type="checkbox"/>	Channel 24	<input type="checkbox"/>	Channel 25	<input type="checkbox"/>	Channel 26	<input type="checkbox"/>	Channel 27	<input type="checkbox"/>	Temperature Sensor	<input type="checkbox"/>	Voltage Sensor	<input type="checkbox"/>	
Channel	Value																																																															
Channel 0	<input checked="" type="checkbox"/>																																																															
Channel 1	<input type="checkbox"/>																																																															
Channel 2	<input type="checkbox"/>																																																															
Channel 3	<input type="checkbox"/>																																																															
Channel 4	<input type="checkbox"/>																																																															
Channel 5	<input type="checkbox"/>																																																															
Channel 6	<input type="checkbox"/>																																																															
Channel 7	<input type="checkbox"/>																																																															
Channel 8	<input type="checkbox"/>																																																															
Channel 9	<input type="checkbox"/>																																																															
Channel 10	<input type="checkbox"/>																																																															
Channel 11	<input type="checkbox"/>																																																															
Channel 12	<input type="checkbox"/>																																																															
Channel 13	<input type="checkbox"/>																																																															
Channel 14	<input type="checkbox"/>																																																															
Channel 15	<input type="checkbox"/>																																																															
Channel 16	<input type="checkbox"/>																																																															
Channel 17	<input type="checkbox"/>																																																															
Channel 18	<input type="checkbox"/>																																																															
Channel 19	<input type="checkbox"/>																																																															
Channel 20	<input type="checkbox"/>																																																															
Channel 21	<input type="checkbox"/>																																																															
Channel 22	<input type="checkbox"/>																																																															
Channel 23	<input type="checkbox"/>																																																															
Channel 24	<input type="checkbox"/>																																																															
Channel 25	<input type="checkbox"/>																																																															
Channel 26	<input type="checkbox"/>																																																															
Channel 27	<input type="checkbox"/>																																																															
Temperature Sensor	<input type="checkbox"/>																																																															
Voltage Sensor	<input type="checkbox"/>																																																															

Figure 2-12 FSP Configuration of ADC Driver [2/4]

g_adc1 ADC (r_adc)		
Settings	Property	Value
API Info	▼ Common	
	Parameter Checking	Default (BSP)
	▼ Module g_adc1 ADC (r_adc)	
	▼ General	
	Name	g_adc1
	Unit	0
	Resolution	🔒 12-Bit
	Alignment	🔒 Right
	Clear after read	🔒 Off
	Mode	Single Scan
	Double-trigger	Disabled
	> Input	
	▼ Interrupts	
	Normal/Group A Trigger	Software
	Group B Trigger	Disabled
	Group Priority (Valid only in Group Scan Mode)	Group A cannot interrupt Group B
	Callback	NULL
	Scan End Interrupt Priority	Disabled
	Scan End Group B Interrupt Priority	Disabled
	Window Compare A Interrupt Priority	Disabled
Window Compare B Interrupt Priority	Disabled	
> Extra		

Figure 2-13 FSP Configuration of ADC Driver [3/4]

g_adc1 ADC (r_adc)		
Settings	Property	Value
API Info	<ul style="list-style-type: none"> <li>▼ Module g_adc1 ADC (r_adc)</li> <li>  &gt; General</li> <li>  ▼ Input               <ul style="list-style-type: none"> <li>    ▼ Channel Scan Mask (channel availability varies by MCU)                   <ul style="list-style-type: none"> <li>Channel 0 <input type="checkbox"/></li> <li>Channel 1 <input type="checkbox"/></li> <li>Channel 2 <input type="checkbox"/></li> <li>Channel 3 <input type="checkbox"/></li> <li>Channel 4 <input checked="" type="checkbox"/></li> <li>Channel 5 <input checked="" type="checkbox"/></li> <li>Channel 6 <input type="checkbox"/></li> <li>Channel 7 <input type="checkbox"/></li> <li>Channel 8 <input type="checkbox"/></li> <li>Channel 9 <input type="checkbox"/></li> <li>Channel 10 <input type="checkbox"/></li> <li>Channel 11 <input type="checkbox"/></li> <li>Channel 12 <input type="checkbox"/></li> <li>Channel 13 <input type="checkbox"/></li> <li>Channel 14 <input type="checkbox"/></li> <li>Channel 15 <input type="checkbox"/></li> <li>Channel 16 <input type="checkbox"/></li> <li>Channel 17 <input type="checkbox"/></li> <li>Channel 18 <input type="checkbox"/></li> <li>Channel 19 <input type="checkbox"/></li> <li>Channel 20 <input type="checkbox"/></li> <li>Channel 21 <input type="checkbox"/></li> <li>Channel 22 <input type="checkbox"/></li> <li>Channel 23 <input type="checkbox"/></li> <li>Channel 24 <input type="checkbox"/></li> <li>Channel 25 <input type="checkbox"/></li> <li>Channel 26 <input type="checkbox"/></li> <li>Channel 27 <input type="checkbox"/></li> <li>Temperature Sensor <input type="checkbox"/></li> <li>Voltage Sensor <input type="checkbox"/></li> </ul> </li> <li>    &gt; Group B Scan Mask (channel availability varies by MCU)</li> <li>    &gt; Addition/Averaging Mask (channel availability varies by MCU and unit)</li> <li>    &gt; Sample and Hold</li> <li>    &gt; Window Compare</li> <li>    Add/Average Count <span style="float: right;">🔒 Disabled</span></li> <li>    Reference Voltage control <span style="float: right;">🔒 VREFH0/VREFH</span></li> <li>    &gt; Interrupts</li> <li>    &gt; Extra</li> </ul> </li> </ul>	

Figure 2-14 FSP Configuration of ADC Driver [4/4]

g_timer3 Timer, Low-Power (r_agt)		
Settings	Property	Value
API Info	▼ Common	
	Parameter Checking	Default (BSP)
	Pin Output Support	Disabled
	Pin Input Support	Disabled
	▼ Module g_timer3 Timer, Low-Power (r_agt)	
	▼ General	
	Name	g_timer3
	Channel	0
	Mode	🔒 Periodic
	Period	1
	Period Unit	Milliseconds
	Count Source	PCLKB
	> Output	
	> Input	
	▼ Interrupts	
Callback	🔒 rm_motor_speed_cyclic	
Underflow Interrupt Priority	Priority 10	

Figure 2-15 FSP Configuration of AGT Driver



g_poeg0 Port Output Enable for GPT (r_poeg)		
Settings	Property	Value
API Info	▼ Common	
	Parameter Checking	Default (BSP)
	▼ Module g_poeg0 Port Output Enable for GPT (r_poeg)	
	▼ General	
	▼ Trigger	
	GTETRГ Pin	<input checked="" type="checkbox"/>
	GPT Output Level	<input type="checkbox"/>
	Oscillation Stop	<input type="checkbox"/>
	Name	g_poeg0
	Channel	1
	▼ Input	
	GTETRГ Polarity	Active Low
	GTETRГ Noise Filter	PCLKB/32
	▼ Interrupts	
	Callback	g_poe_overcurrent
Interrupt Priority	Priority 0 (highest)	

Figure 2-17 FSP Configuration of POEG Driver

### 2.2.4.3 RA6T3

#### (1). 12-bit A/D Converter (ADC12)

Phase current (with an 1shunt resistance), inverter bus voltage (Vdc) and rotation speed command (VR1) are measured in "Single scan mode" (use a hardware trigger).

Detection of the phase current uses FIFO function.

A/D conversion is implemented to be synchronized with carrier synchronized interrupt by using direct link function to GPT.

#### (2). Low Power Asynchronous General-Purpose Timer (AGT)

The AGT is used as 1 [ms] interval timer.

#### (3). General PWM Timer (GPT)

On the channel 1, 2, and 3, output with dead time is performed by using the Triangle-wave PWM mode 3. .

#### (4). Port Output Enable for GPT (POEG)

The port executing PWM output are set to high impedance state when an overcurrent is detected (when a low level of the GTETRGB port is detected) .

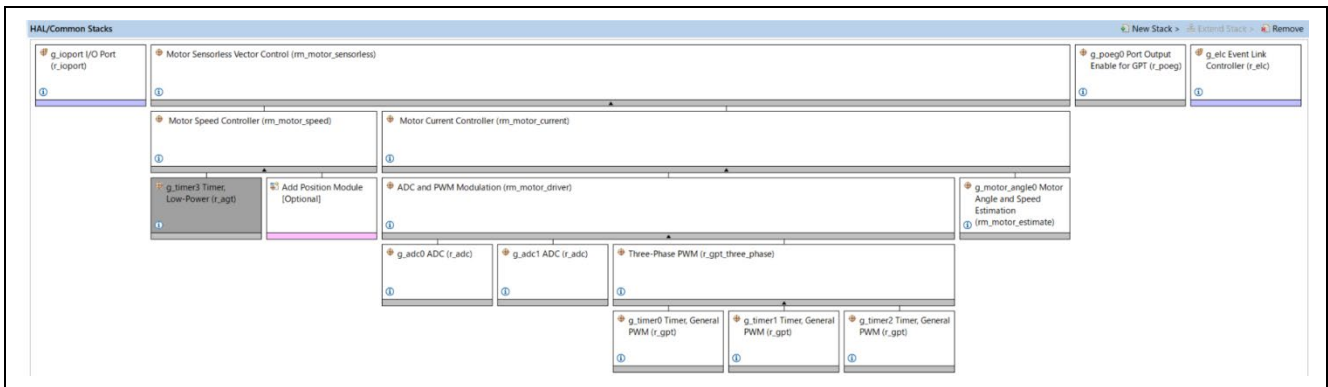

Figure 2-18 Overall FSP Stacks diagram



g_adc0 ADC (r_adc)		
Settings	Property	Value
API Info	<ul style="list-style-type: none"> <li>▼ Common</li> </ul>	
	Parameter Checking	Default (BSP)
	<ul style="list-style-type: none"> <li>▼ Module g_adc0 ADC (r_adc)</li> </ul>	
	<ul style="list-style-type: none"> <li>▼ General</li> </ul>	
	Name	g_adc0
	Unit	0
	Resolution	🔒 12-Bit
	Alignment	🔒 Right
	Clear after read	On
	Mode	Single Scan
	Double-trigger	Enabled (extended mode)
	> Input	
	<ul style="list-style-type: none"> <li>▼ Interrupts</li> </ul>	
	Normal/Group A Trigger	GPT1 AD TRIG A (A/D converter start request A)
	Group B Trigger	GPT1 AD TRIG B (A/D converter start request B)
	Group Priority (Valid only in Group Scan Mode)	Group A cannot interrupt Group B
	Callback	NULL
	Scan End Interrupt Priority	Disabled
	Scan End Group B Interrupt Priority	Disabled
	Window Compare A Interrupt Priority	Disabled
	Window Compare B Interrupt Priority	Disabled
	> Extra	

Figure 2-19 FSP Configuration of ADC Driver [1/4]



g_adc0 ADC (r_adc)																																																																		
Settings	Property	Value																																																																
API Info	<ul style="list-style-type: none"> <li>▼ Module g_adc0 ADC (r_adc)               <ul style="list-style-type: none"> <li>&gt; General</li> <li>▼ Input                   <ul style="list-style-type: none"> <li>▼ Channel Scan Mask (channel availability varies by MCU)                       <table border="0" style="width: 100%; border-collapse: collapse;"> <tr><td style="width: 80%;">Channel 0</td><td style="text-align: right;"><input checked="" type="checkbox"/></td></tr> <tr><td>Channel 1</td><td style="text-align: right;"><input type="checkbox"/></td></tr> <tr><td>Channel 2</td><td style="text-align: right;"><input type="checkbox"/></td></tr> <tr><td>Channel 3</td><td style="text-align: right;"><input type="checkbox"/></td></tr> <tr><td>Channel 4</td><td style="text-align: right;"><input type="checkbox"/></td></tr> <tr><td>Channel 5</td><td style="text-align: right;"><input type="checkbox"/></td></tr> <tr><td>Channel 6</td><td style="text-align: right;"><input type="checkbox"/></td></tr> <tr><td>Channel 7</td><td style="text-align: right;"><input type="checkbox"/></td></tr> <tr><td>Channel 8</td><td style="text-align: right;"><input type="checkbox"/></td></tr> <tr><td>Channel 9</td><td style="text-align: right;"><input type="checkbox"/></td></tr> <tr><td>Channel 10</td><td style="text-align: right;"><input type="checkbox"/></td></tr> <tr><td>Channel 11</td><td style="text-align: right;"><input type="checkbox"/></td></tr> <tr><td>Channel 12</td><td style="text-align: right;"><input type="checkbox"/></td></tr> <tr><td>Channel 13</td><td style="text-align: right;"><input type="checkbox"/></td></tr> <tr><td>Channel 14</td><td style="text-align: right;"><input type="checkbox"/></td></tr> <tr><td>Channel 15</td><td style="text-align: right;"><input type="checkbox"/></td></tr> <tr><td>Channel 16</td><td style="text-align: right;"><input type="checkbox"/></td></tr> <tr><td>Channel 17</td><td style="text-align: right;"><input type="checkbox"/></td></tr> <tr><td>Channel 18</td><td style="text-align: right;"><input type="checkbox"/></td></tr> <tr><td>Channel 19</td><td style="text-align: right;"><input type="checkbox"/></td></tr> <tr><td>Channel 20</td><td style="text-align: right;"><input type="checkbox"/></td></tr> <tr><td>Channel 21</td><td style="text-align: right;"><input type="checkbox"/></td></tr> <tr><td>Channel 22</td><td style="text-align: right;"><input type="checkbox"/></td></tr> <tr><td>Channel 23</td><td style="text-align: right;"><input type="checkbox"/></td></tr> <tr><td>Channel 24</td><td style="text-align: right;"><input type="checkbox"/></td></tr> <tr><td>Channel 25</td><td style="text-align: right;"><input type="checkbox"/></td></tr> <tr><td>Channel 26</td><td style="text-align: right;"><input type="checkbox"/></td></tr> <tr><td>Channel 27</td><td style="text-align: right;"><input type="checkbox"/></td></tr> <tr><td>Temperature Sensor</td><td style="text-align: right;"><input type="checkbox"/></td></tr> <tr><td>Voltage Sensor</td><td style="text-align: right;"><input type="checkbox"/></td></tr> </table> </li> <li>&gt; Group B Scan Mask (channel availability varies by MCU)</li> <li>&gt; Addition/Averaging Mask (channel availability varies by MCU and unit)</li> <li>&gt; Sample and Hold</li> <li>&gt; Window Compare</li> <tr><td>Add/Average Count</td><td style="text-align: right;">🔒 Disabled</td></tr> <tr><td>Reference Voltage control</td><td style="text-align: right;">🔒 VREFH0/VREFH</td></tr> <li>&gt; Interrupts</li> <li>&gt; Extra</li> </ul> </li> </ul> </li></ul>	Channel 0	<input checked="" type="checkbox"/>	Channel 1	<input type="checkbox"/>	Channel 2	<input type="checkbox"/>	Channel 3	<input type="checkbox"/>	Channel 4	<input type="checkbox"/>	Channel 5	<input type="checkbox"/>	Channel 6	<input type="checkbox"/>	Channel 7	<input type="checkbox"/>	Channel 8	<input type="checkbox"/>	Channel 9	<input type="checkbox"/>	Channel 10	<input type="checkbox"/>	Channel 11	<input type="checkbox"/>	Channel 12	<input type="checkbox"/>	Channel 13	<input type="checkbox"/>	Channel 14	<input type="checkbox"/>	Channel 15	<input type="checkbox"/>	Channel 16	<input type="checkbox"/>	Channel 17	<input type="checkbox"/>	Channel 18	<input type="checkbox"/>	Channel 19	<input type="checkbox"/>	Channel 20	<input type="checkbox"/>	Channel 21	<input type="checkbox"/>	Channel 22	<input type="checkbox"/>	Channel 23	<input type="checkbox"/>	Channel 24	<input type="checkbox"/>	Channel 25	<input type="checkbox"/>	Channel 26	<input type="checkbox"/>	Channel 27	<input type="checkbox"/>	Temperature Sensor	<input type="checkbox"/>	Voltage Sensor	<input type="checkbox"/>	Add/Average Count	🔒 Disabled	Reference Voltage control	🔒 VREFH0/VREFH	
Channel 0	<input checked="" type="checkbox"/>																																																																	
Channel 1	<input type="checkbox"/>																																																																	
Channel 2	<input type="checkbox"/>																																																																	
Channel 3	<input type="checkbox"/>																																																																	
Channel 4	<input type="checkbox"/>																																																																	
Channel 5	<input type="checkbox"/>																																																																	
Channel 6	<input type="checkbox"/>																																																																	
Channel 7	<input type="checkbox"/>																																																																	
Channel 8	<input type="checkbox"/>																																																																	
Channel 9	<input type="checkbox"/>																																																																	
Channel 10	<input type="checkbox"/>																																																																	
Channel 11	<input type="checkbox"/>																																																																	
Channel 12	<input type="checkbox"/>																																																																	
Channel 13	<input type="checkbox"/>																																																																	
Channel 14	<input type="checkbox"/>																																																																	
Channel 15	<input type="checkbox"/>																																																																	
Channel 16	<input type="checkbox"/>																																																																	
Channel 17	<input type="checkbox"/>																																																																	
Channel 18	<input type="checkbox"/>																																																																	
Channel 19	<input type="checkbox"/>																																																																	
Channel 20	<input type="checkbox"/>																																																																	
Channel 21	<input type="checkbox"/>																																																																	
Channel 22	<input type="checkbox"/>																																																																	
Channel 23	<input type="checkbox"/>																																																																	
Channel 24	<input type="checkbox"/>																																																																	
Channel 25	<input type="checkbox"/>																																																																	
Channel 26	<input type="checkbox"/>																																																																	
Channel 27	<input type="checkbox"/>																																																																	
Temperature Sensor	<input type="checkbox"/>																																																																	
Voltage Sensor	<input type="checkbox"/>																																																																	
Add/Average Count	🔒 Disabled																																																																	
Reference Voltage control	🔒 VREFH0/VREFH																																																																	

Figure 2-20 FSP Configuration of ADC Driver [2/4]

g_adc1 ADC (r_adc)		
Settings	Property	Value
API Info	▼ Common	
	Parameter Checking	Default (BSP)
	▼ Module g_adc1 ADC (r_adc)	
	▼ General	
	Name	g_adc1
	Unit	0
	Resolution	🔒 12-Bit
	Alignment	🔒 Right
	Clear after read	🔒 Off
	Mode	Single Scan
	Double-trigger	Disabled
	> Input	
	▼ Interrupts	
	Normal/Group A Trigger	Software
	Group B Trigger	Disabled
	Group Priority (Valid only in Group Scan Mode)	Group A cannot interrupt Group B
	Callback	NULL
	Scan End Interrupt Priority	Disabled
	Scan End Group B Interrupt Priority	Disabled
	Window Compare A Interrupt Priority	Disabled
Window Compare B Interrupt Priority	Disabled	
> Extra		

Figure 2-21 FSP Configuration of ADC Driver [3/4]

g_adc1 ADC (r_adc)		
Settings	Property	Value
API Info	<ul style="list-style-type: none"> <li>▼ Module g_adc1 ADC (r_adc)</li> <li>  &gt; General</li> <li>  ▼ Input               <ul style="list-style-type: none"> <li>▼ Channel Scan Mask (channel availability varies by MCU)                   <ul style="list-style-type: none"> <li>Channel 0 <input type="checkbox"/></li> <li>Channel 1 <input type="checkbox"/></li> <li>Channel 2 <input type="checkbox"/></li> <li>Channel 3 <input type="checkbox"/></li> <li>Channel 4 <input checked="" type="checkbox"/></li> <li>Channel 5 <input checked="" type="checkbox"/></li> <li>Channel 6 <input type="checkbox"/></li> <li>Channel 7 <input type="checkbox"/></li> <li>Channel 8 <input type="checkbox"/></li> <li>Channel 9 <input type="checkbox"/></li> <li>Channel 10 <input type="checkbox"/></li> <li>Channel 11 <input type="checkbox"/></li> <li>Channel 12 <input type="checkbox"/></li> <li>Channel 13 <input type="checkbox"/></li> <li>Channel 14 <input type="checkbox"/></li> <li>Channel 15 <input type="checkbox"/></li> <li>Channel 16 <input type="checkbox"/></li> <li>Channel 17 <input type="checkbox"/></li> <li>Channel 18 <input type="checkbox"/></li> <li>Channel 19 <input type="checkbox"/></li> <li>Channel 20 <input type="checkbox"/></li> <li>Channel 21 <input type="checkbox"/></li> <li>Channel 22 <input type="checkbox"/></li> <li>Channel 23 <input type="checkbox"/></li> <li>Channel 24 <input type="checkbox"/></li> <li>Channel 25 <input type="checkbox"/></li> <li>Channel 26 <input type="checkbox"/></li> <li>Channel 27 <input type="checkbox"/></li> <li>Temperature Sensor <input type="checkbox"/></li> <li>Voltage Sensor <input type="checkbox"/></li> </ul> </li> <li>  &gt; Group B Scan Mask (channel availability varies by MCU)</li> <li>  &gt; Addition/Averaging Mask (channel availability varies by MCU and unit)</li> <li>  &gt; Sample and Hold</li> <li>  &gt; Window Compare</li> <li>  Add/Average Count <span style="float: right;">🔒 Disabled</span></li> <li>  Reference Voltage control <span style="float: right;">🔒 VREFH0/VREFH</span></li> <li>  &gt; Interrupts</li> <li>  &gt; Extra</li> </ul> </li> </ul>	

Figure 2-22 FSP Configuration of ADC Driver [4/4]

g_timer3 Timer, Low-Power (r_agt)		
Settings	Property	Value
API Info	▼ Common	
	Parameter Checking	Default (BSP)
	Pin Output Support	Disabled
	Pin Input Support	Disabled
	▼ Module g_timer3 Timer, Low-Power (r_agt)	
	▼ General	
	Name	g_timer3
	Channel	0
	Mode	🔒 Periodic
	Period	1
	Period Unit	Milliseconds
	Count Source	PCLKB
	> Output	
	> Input	
	▼ Interrupts	
Callback	🔒 rm_motor_speed_cyclic	
Underflow Interrupt Priority	Priority 10	

Figure 2-23 FSP Configuration of AGT Driver



g_poeg0 Port Output Enable for GPT (r_poeg)		
Settings	Property	Value
API Info	▼ Common	
	Parameter Checking	Default (BSP)
	▼ Module g_poeg0 Port Output Enable for GPT (r_poeg)	
	▼ General	
	▼ Trigger	
	GTETRГ Pin	<input checked="" type="checkbox"/>
	GPT Output Level	<input type="checkbox"/>
	Oscillation Stop	<input type="checkbox"/>
	Name	g_poeg0
	Channel	1
	▼ Input	
	GTETRГ Polarity	Active Low
	GTETRГ Noise Filter	PCLKB/32
	▼ Interrupts	
	Callback	g_poe_overcurrent
Interrupt Priority	Priority 0 (highest)	

Figure 2-25 FSP Configuration of POEG Driver

2.2.4.4 RA8T1

(1). 12-bit A/D Converter (ADC12)

Phase current (with an 1shunt resistance), inverter bus voltage (Vdc) and rotation speed command (VR1) are measured in "Single scan mode" (use a hardware trigger).

Detection of the phase current uses FIFO function.

A/D conversion is implemented to be synchronized with carrier synchronized interrupt by using direct link function to GPT.

(2). Low Power Asynchronous General-Purpose Timer (AGT)

The AGT is used as 1 [ms] interval timer.

(3). General PWM Timer (GPT)

On the channel 5, 2, and 3, output with dead time is performed by using the Triangle-wave PWM mode 3.

(4). Port Output Enable for GPT (POEG)

The port executing PWM output are set to high impedance state when an overcurrent is detected (when a low level of the GTETRGA port is detected) .

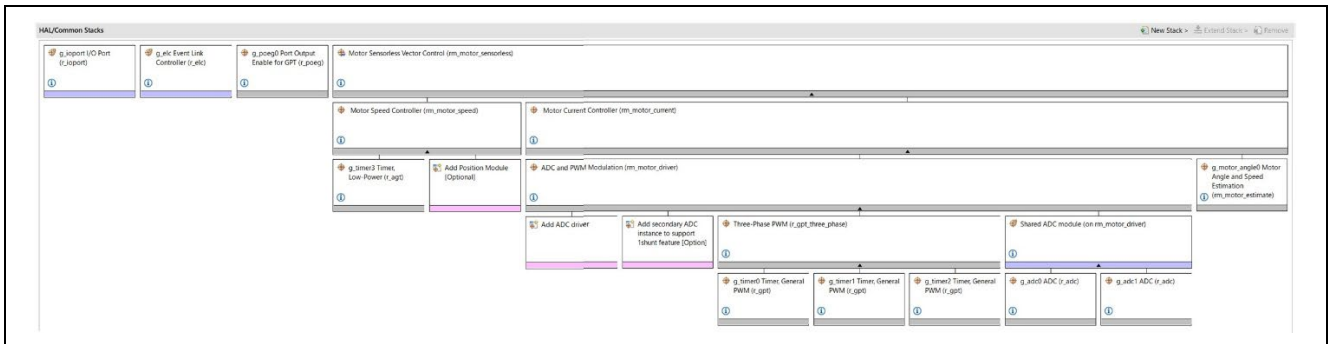

Figure 2-26 Overall FSP Stacks diagram

g_adc0 ADC (r_adc)	
Property	Value
Settings	
API Info	
Common	
Parameter Checking	Default (BSP)
Module g_adc0 ADC (r_adc)	
General	
Name	g_adc0
Unit	0
Resolution	12-Bit
Alignment	Right
Clear after read	On
Mode	Single Scan
Double-trigger	Enabled (extended mode)
Input	
Interrupts	
Normal/Group A Trigger	GPT1 AD TRIG A (A/D converter start request A)
Group B Trigger	GPT1 AD TRIG B (A/D converter start request B)
Group Priority (Valid only in Group Scan Mode)	Group A cannot interrupt Group B
Callback	NULL
Scan End Interrupt Priority	Disabled
Scan End Group B Interrupt Priority	Disabled
Window Compare A Interrupt Priority	Disabled
Window Compare B Interrupt Priority	Disabled
Extra	

Figure 2-27 FSP Configuration of ADC Driver [1/4]



g_adc0 ADC (r_adc)		
Settings	Property	Value
API Info	<ul style="list-style-type: none"> <li>▼ Module g_adc0 ADC (r_adc)                             <ul style="list-style-type: none"> <li>&gt; General</li> <li>▼ Input                                     <ul style="list-style-type: none"> <li>▼ Channel Scan Mask (channel availability varies by MCU)   <ul style="list-style-type: none"> <li>Channel 0 <input checked="" type="checkbox"/></li> <li>Channel 1 <input type="checkbox"/></li> <li>Channel 2 <input type="checkbox"/></li> <li>Channel 3 <input type="checkbox"/></li> <li>Channel 4 <input type="checkbox"/></li> <li>Channel 5 <input type="checkbox"/></li> <li>Channel 6 <input type="checkbox"/></li> <li>Channel 7 <input type="checkbox"/></li> <li>Channel 8 <input type="checkbox"/></li> <li>Channel 9 <input type="checkbox"/></li> <li>Channel 10 <input type="checkbox"/></li> <li>Channel 11 <input type="checkbox"/></li> <li>Channel 12 <input type="checkbox"/></li> <li>Channel 13 <input type="checkbox"/></li> <li>Channel 14 <input type="checkbox"/></li> <li>Channel 15 <input type="checkbox"/></li> <li>Channel 16 <input type="checkbox"/></li> <li>Channel 17 <input type="checkbox"/></li> <li>Channel 18 <input type="checkbox"/></li> <li>Channel 19 <input type="checkbox"/></li> <li>Channel 20 <input type="checkbox"/></li> <li>Channel 21 <input type="checkbox"/></li> <li>Channel 22 <input type="checkbox"/></li> <li>Channel 23 <input type="checkbox"/></li> <li>Channel 24 <input type="checkbox"/></li> <li>Channel 25 <input type="checkbox"/></li> <li>Channel 26 <input type="checkbox"/></li> <li>Channel 27 <input type="checkbox"/></li> <li>Temperature Sensor <input type="checkbox"/></li> <li>Voltage Sensor <input type="checkbox"/></li> </ul> </li> <li>&gt; Group B Scan Mask (channel availability varies by MCU)</li> <li>&gt; Addition/Averaging Mask (channel availability varies by MCU and unit)</li> <li>&gt; Sample and Hold</li> <li>&gt; Window Compare</li> <li>Add/Average Count <span style="float: right;">🔒 Disabled</span></li> <li>Reference Voltage control <span style="float: right;">🔒 VREFH0/VREFH</span></li> <li>&gt; Interrupts</li> <li>&gt; Extra</li> </ul> </li> </ul> </li> </ul>	

Figure 2-28 FSP Configuration of ADC Driver [2/4]



g_adc1 ADC (r_adc)		
Settings	Property	Value
API Info	▼ Common	
	Parameter Checking	Default (BSP)
	▼ Module g_adc1 ADC (r_adc)	
	▼ General	
	Name	g_adc1
	Unit	0
	Resolution	🔒 12-Bit
	Alignment	🔒 Right
	Clear after read	🔒 Off
	Mode	Single Scan
	Double-trigger	Disabled
	> Input	
	▼ Interrupts	
	Normal/Group A Trigger	Software
	Group B Trigger	Disabled
	Group Priority (Valid only in Group Scan Mode)	Group A cannot interrupt Group B
	Callback	NULL
	Scan End Interrupt Priority	Disabled
	Scan End Group B Interrupt Priority	Disabled
	Window Compare A Interrupt Priority	Disabled
	Window Compare B Interrupt Priority	Disabled
	> Extra	

Figure 2-29 FSP Configuration of ADC Driver [3/4]

g_adc1 ADC (r_adc)		
Settings	Property	Value
API Info	▼ Module g_adc1 ADC (r_adc)	
	> General	
	▼ Input	
	▼ Channel Scan Mask (channel availability varies by MCU)	
	Channel 0	<input type="checkbox"/>
	Channel 1	<input type="checkbox"/>
	Channel 2	<input type="checkbox"/>
	Channel 3	<input type="checkbox"/>
	Channel 4	<input checked="" type="checkbox"/>
	Channel 5	<input checked="" type="checkbox"/>
	Channel 6	<input type="checkbox"/>
	Channel 7	<input type="checkbox"/>
	Channel 8	<input type="checkbox"/>
	Channel 9	<input type="checkbox"/>
	Channel 10	<input type="checkbox"/>
	Channel 11	<input type="checkbox"/>
	Channel 12	<input type="checkbox"/>
	Channel 13	<input type="checkbox"/>
	Channel 14	<input type="checkbox"/>
	Channel 15	<input type="checkbox"/>
	Channel 16	<input type="checkbox"/>
	Channel 17	<input type="checkbox"/>
	Channel 18	<input type="checkbox"/>
	Channel 19	<input type="checkbox"/>
	Channel 20	<input type="checkbox"/>
	Channel 21	<input type="checkbox"/>
	Channel 22	<input type="checkbox"/>
	Channel 23	<input type="checkbox"/>
	Channel 24	<input type="checkbox"/>
	Channel 25	<input type="checkbox"/>
	Channel 26	<input type="checkbox"/>
	Channel 27	<input type="checkbox"/>
	Temperature Sensor	<input type="checkbox"/>
	Voltage Sensor	<input type="checkbox"/>
	> Group B Scan Mask (channel availability varies by MCU)	
	> Addition/Averaging Mask (channel availability varies by MCU and unit)	
	> Sample and Hold	
	> Window Compare	
	Add/Average Count	🔒 Disabled
	Reference Voltage control	🔒 VREFH0/VREFH
	> Interrupts	
	> Extra	

Figure 2-30 FSP Configuration of ADC Driver [4/4]

g_timer3 Timer, Low-Power (r_agt)		
Settings	Property	Value
API Info	▼ Common	
	Parameter Checking	Default (BSP)
	Pin Output Support	Disabled
	Pin Input Support	Disabled
	▼ Module g_timer3 Timer, Low-Power (r_agt)	
	▼ General	
	Name	g_timer3
	Channel	0
	Mode	Periodic
	Period	1
	Period Unit	Milliseconds
	Count Source	PCLKB
	> Output	
	> Input	
	▼ Interrupts	
	Callback	rm_motor_speed_cyclic
	Underflow Interrupt Priority	Priority 10

Figure 2-31 FSP Configuration of AGT Driver

g_timer0 Timer, General PWM (r_gpt)		
Settings	Property	Value
API Info	▼ Common	
	Parameter Checking	Default (BSP)
	Pin Output Support	Enabled with Extra Features
	Write Protect Enable	Disabled
	Clock Source	PCLKD
	▼ Module g_timer0 Timer, General PWM (r_gpt)	
	▼ General	
	Name	g_timer0
	Channel	1
	Mode	Triangle-Wave Asymmetric PWM (Mode 3)
	Period	100
	Period Unit	Microseconds
	> Output	
	> Input	
	▼ Interrupts	
	Callback	rm_motor_driver_1shunt_cyclic
	Overflow/Crest Interrupt Priority	Priority 5
	Capture A Interrupt Priority	Disabled
	Capture B Interrupt Priority	Disabled
	Underflow/Trough Interrupt Priority	Disabled
	▼ Extra Features	
	▼ Output Disable	
	> Output Disable POEG Trigger	
	POEG Link	POEG Channel 1
	GTIOCA Disable Setting	Level Low
	GTIOCB Disable Setting	Level Low
	▼ ADC Trigger	
	▼ Start Event Trigger (Channels with GTINTAD only)	
	Trigger Event A/D Converter Start Request A During Up Counting	<input checked="" type="checkbox"/>
	Trigger Event A/D Converter Start Request A During Down Counting	<input type="checkbox"/>
	Trigger Event A/D Converter Start Request B During Up Counting	<input checked="" type="checkbox"/>
	Trigger Event A/D Converter Start Request B During Down Counting	<input type="checkbox"/>
	▼ Dead Time	
	Dead Time Count Up (Raw Counts)	200
	Dead Time Count Down (Raw Counts) (Channels with GTDVD only)	200
	▼ ADC Trigger (Channels with GTADTRA only)	
	ADC A Compare Match (Raw Counts)	10
	▼ ADC Trigger (Channels with GTADTRB only)	
	ADC B Compare Match (Raw Counts)	80
	▼ Interrupt Skipping (Channels with GTITC only)	
	Interrupt to Count	Trough (triangle)
	Interrupt Skip Count	1
	Skip ADC Events	None
	Extra Features	Enabled

Figure 2-32 FSP Configuration of GPT Driver

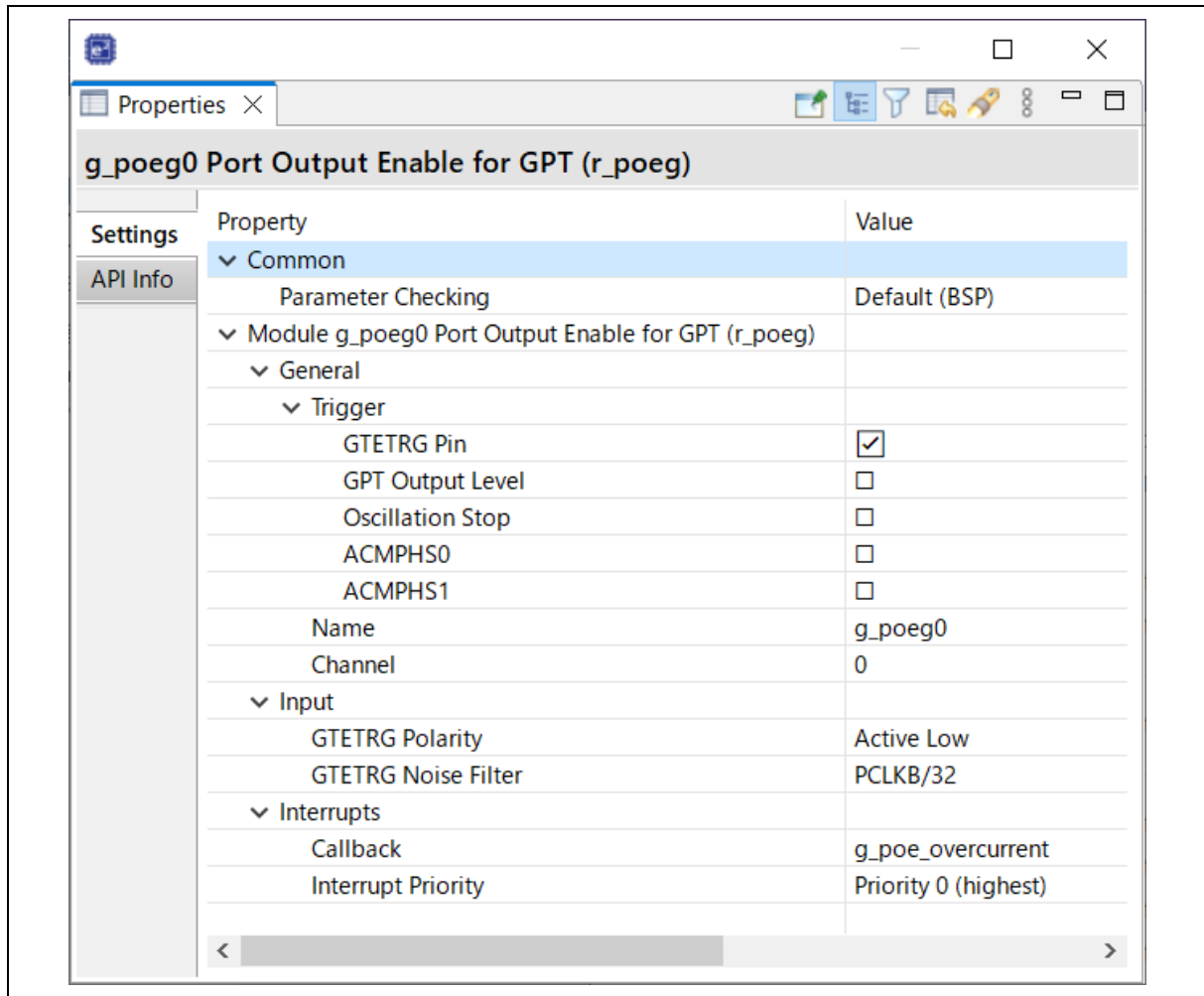

Figure 2-33 FSP Configuration of POEG Driver

## 2.3 Software configuration

### 2.3.1 Software file configuration

Folder and file configuration of the software is given below.

**Table 2-6 File and folder configuration[1/2]**

Folder	Subfolder	File	Remarks	
ra_cfg			Generated config header	
ra_gen			Generated register setting, main function etc.	
ra	arm		CMSIS source code	
	board		Function definition for board	
	fsp/inc/api	bsp_api.h		BSP API definition
		r_adc_api.h		AD API definition
		r_elc_api.h(Only RA4T1, RA6T3 and RA8T1)		ELC API definition
		r_ioport_api.h		I/O API definition
		r_poeg_api.h		POEG API definition
		r_three_phase_api.h		3phase PWM API definition
		r_timer_api.h		Timer API definition
		r_transfer_api.h		Transfer API definition
		rm_motor_angle_api.h		Angle API definition
		rm_motor_api.h		Motor API definition
		rm_motor_current_api.h		Current API definition
		rm_motor_driver_api.h		Motor driver API definition
		rm_motor_position_api.h		Position API definition
		rm_motor_speed_api.h		Speed API definition
	fsp/inc/instances	r_adc_b.h(RA6T2)		Function definition for AD
		r_adc.h(RA4T1,RA6T3 and RA8T1)		
		r_agt.h		Function definition for AGT
		r_elc.h(Only RA4T1, RA6T3 and RA8T1)		Function definition for ELC
		r_gpt_three_phase.h		Function definition for 3 Phase PWM
		r_gpt.h		Function definition for GPT
		r_ioport.h		Function definition for I/O
		r_poeg.h		Function definition for POEG
		rm_motor_current.h		Function definition for current control
		rm_motor_driver.h		Function definition for motor driver
		rm_motor_estimate.h		Function definition for angle estimate
		rm_motor_sensorless.h		Function definition for Sensorless
		rm_motor_speed.h		Function definition for Speed

Table 2-7 File and folder configuration[2/2]

Folder	Subfolder	File	Remarks
ra	fsp/lib		Library files
	fsp/src	bsp	BSP driver
		r_adc_b/r_adc_b.c(RA6T2)	AD driver
		r_adc/r_adc.c(RA4T1,RA6T3 and RA8T1)	
		r_agt/r_agt.c	AGT driver
		r_elc/r_elc.c(Only RA4T1, RA6T3 and RA8T1)	ELC driver
		r_gpt/r_gpt.c	GPT driver
		r_gpt_three_phase/ r_gpt_three_phase.c	3 phase PWM driver
		r_ioport/r_ioport.c	I/O driver
		r_poeg/r_poeg.c	POEG driver
		rm_motor_current/rm_motor_current.c	Current control driver
		rm_motor_current/rm_motor_current_library.h	Current control library API definition
		rm_motor_driver/rm_motor_driver.c	Motor driver
		rm_motor_estimate.c	Angle estimate driver
		rm_motor_estimate_library.h	Angle estimate library API definition
		rm_motor_sensorless.c	Sensorless driver
		rm_motor_speed/rm_motor_speed.c	Speed control driver
rm_motor_speed/rm_motor_speed_library.h	Speed control library API definition		
src	application/main	mtr_main.h , mtr_main.c	User main function
		r_mtr_control_parameter.h	Control parameters definition
		r_mtr_motor_parameter.h	Motor parameters definition
	application/user_interface/ics	r_mtr_ics.h , r_mtr_ics.c	Function definition for Analyzer
		ICS2_RA6T2.h , ICS2_RA4T1.h , ICS2_RA6T3.h , ICS2_RA8T1.h	Function definition for GUI tool
		ICS2_RA6T2.o , ICS2_RA4T1.o , ICS2_RA6T3.o , ICS2_RA8T1.o	Communication library for GUI tool

### 2.3.2 Module configuration

Module configuration of the software is described below.

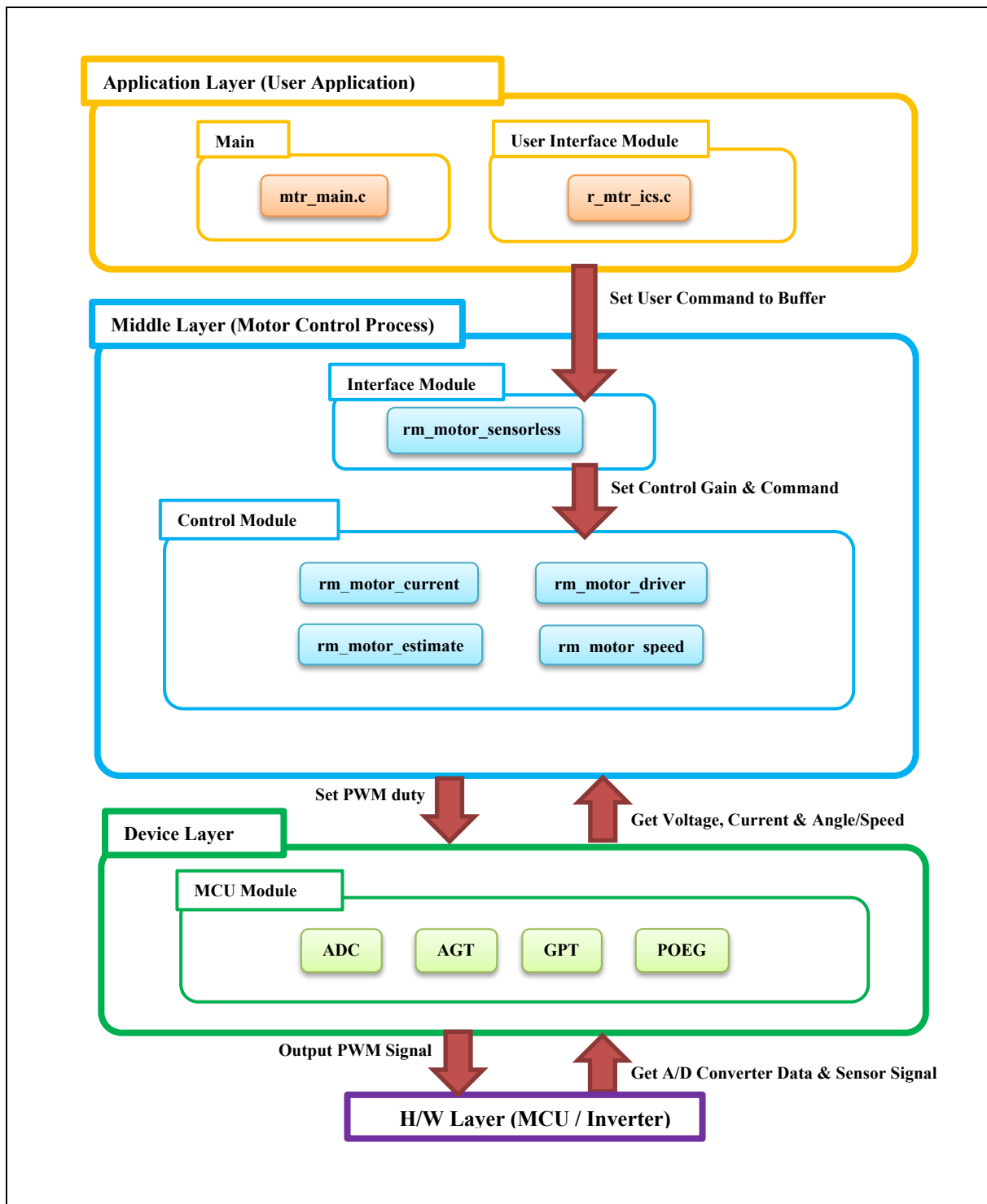

Figure 2-34 Module Configuration

## 2.4 Software specifications

Table 2-8 shows basic software specification of this system. For details of the sensorless vector control, refer to the application note 'Sensorless vector control for permanent magnet synchronous motor (Algorithm)' (R01AN3786).

**Table 2-8 Basic Specifications of Sensorless Vector Control Software**

Item	Content	
Control method	Vector control	
Position detection method	Sensorless	
Motor rotation start/stop	SW1 input or input from 'Renesas Motor Workbench'	
Input voltage	DC 24 [V]	
Main clock frequency	RA6T2: 240 [MHz] RA6T3: 200 [MHz] RA4T1: 100 [MHz] RA8T1: 480 [MHz]	
Carrier frequency (PWM)	10 [kHz] (Carrier period: 100 [μs])	
Dead time	2 [μs]	
Current control period	RA6T2: 100 [μs] RA6T3: 100 [μs] RA4T1: 200 [μs] RA8T1: 100 [μs]	
Speed control period	RA6T2: 1000 [μs] RA6T3: 1000 [μs] RA4T1: 2000 [μs] RA8T1: 1000 [μs]	
Rotation speed control range	CW: 0 [rpm] to 2400 [rpm] CCW: 0 [rpm] to 2400 [rpm] However, 500 [rpm] or less is driven by a speed open loop.	
Natural frequency of each control system	Current control system : 300 [Hz] Speed control system : 5 [Hz] BEMF estimation system : 1000 [Hz] Position estimation system : 50 [Hz]	
Optimization setting of compiler	Optimization level	Optimize more(-O2) (default setting)
Processing stop for protection	<p>Disables the motor control signal output (six outputs), under any of the following conditions.</p> <ol style="list-style-type: none"> <li>1. Instantaneous value of current of any phase exceeds <math>3.54(=1.67 \times \sqrt{2} \times 1.5)</math> [A] (monitored in current control period)</li> <li>2. Inverter bus voltage exceeds 60 [V] (monitored in current control period)</li> <li>3. Inverter bus voltage is less than 8 [V] (monitored in current control period)</li> <li>4. Rotation speed exceeds 4500 [rpm] (monitored in current control period)</li> </ol> <p>When an external over current signal is detected (when a low level is detected), the PWM output ports are set to high impedance state.</p>	

## 2.5 Interrupt Priority

Table 2-9 shows the interrupt and priorities used in this system.

**Table 2-9 Interrupt priority**

Interrupt level	Priority	function
15		
14		
13		
12		
11		
10		AGT0 INT Speed control Interrupt
9		
8		
7		
6		
5		GPT4 COUNTER OVERFLOW(RA6T2) GPT1 COUNTER OVERFLOW (RA4T1,RA6T3) GPT5 COUNTER OVERFLOW (RA8T1) GPT overflow Interrupt
4		
3		
2		
1		
0		POEG3 EVENT(RA6T2) POEG1 EVENT(RA4T1,RA6T3) POEG0 EVENT(RA8T1) Over current error interrupt

Allocations		
Interrupt	Event	ISR
0	AGT0 INT (AGT interrupt)	agt_int_isr
1	GPT4 COUNTER OVERFLOW (Overflow)	gpt_counter_overflow_isr
2	POEG3 EVENT (Port Output disable interrupt D)	poeg_event_isr

Figure 2-35 RA6T2 FSP Interrupts Configuration

Allocations		
Interrupt	Event	ISR
0	AGT0 INT (AGT interrupt)	agt_int_isr
1	GPT1 COUNTER OVERFLOW (Overflow)	gpt_counter_overflow_isr
2	POEG1 EVENT (Port Output disable interrupt B)	poeg_event_isr

Figure 2-36 RA4T1/RA6T3 FSP Interrupts Configuration

Allocations		
Interrupt	Event	ISR
0	POEG0 EVENT (Port Output disable interrupt A)	poeg_event_isr
1	AGT1 INT (AGT interrupt)	agt_int_isr
2	GPT2 COUNTER OVERFLOW (Overflow)	gpt_counter_overflow_isr

Figure 2-37 RA8T1 FSP Interrupts Configuration



### 3. Descriptions of the control program

The target software of this application note is explained here.

#### 3.1 Contents of control

##### 3.1.1 Motor start/stop

Starting and stopping of the motor are controlled by input from 'Renesas Motor Workbench' or SW1.

A general-purpose port is assigned to SW1 and based upon its level the motor operation is controlled.

"High" level → Motor Start

"Low" level → Motor Stop

##### 3.1.2 A/D Converter

###### (1) Motor rotation speed reference

The rotation speed command value of the motor is determined from the input from 'Renesas Motor Workbench' or the output value (analog value) of VR1. Rotation speed command value from VR1 is measured as shown in the table below.

**Table 3-1 Conversion Ratio of the Rotation Speed Reference**

Item	Conversion ratio (reference: A/D conversion value)		Channel
Rotation speed reference	CW	0 rpm to 2400 rpm: 0800H to 0FFFH	AN008
	CCW	0 rpm to 2400 rpm: 07FFH to 0000H	

###### (2) Inverter bus voltage

Inverter bus voltage is measured as shown in the table below. It is used for calculation of modulation rate and detection of overvoltage and low voltage (PWM stops in case of abnormality).

**Table 3-2 Inverter Bus Voltage Conversion Ratio**

Item	Conversion ratio (Inverter bus voltage: A/D conversion value)	Channel
Inverter bus voltage	0 [V] to 73.26 [V]: 0000H to 0FFFH	AN006

###### (3) Phase current with 1shunt resistance

The phase currents are measured as shown in Table 3-3 and used for vector control.

**Table 3-3 Conversion Ratio of Phase Current**

Item	Conversion ratio (Phase current: A/D conversion value)	Channel
Phase current	-8.25 [A] to 8.25 [A]: 0000H to 0FFFH <sup>(Note)</sup>	AN004
	Current = (3.3V-1.65V)/(0.01Ohm * 20) =8.25A	

### 3.1.3 Modulation (current control module)

A modulated voltage can be output to improve the efficiency of voltage usage. The modulation operation is set from the API of the current control module.

#### (a) Sine wave modulation (MOD\_METHOD\_SPWM)

The modulation factor  $m$  is defined as follows.

$$m = \frac{V}{E}$$

$m$ : Modulation ratio     $V$ : Reference voltage     $E$ : Inverter input voltage

#### (b) Space Vector Modulation (MOD\_METHOD\_SVPWM) \*

In vector control of a permanent magnet synchronous motor, generally, the desired voltage command value of each phase is generated sinusoidally. However, if the generated value is used as-is for the modulation wave for PWM generation, voltage utilization as applied to the motor (in terms of line voltage) is limited to a maximum of 86.7% with respect to inverter bus voltage. As such, as shown in the following expression, the average of the maximum and minimum values is calculated for the voltage command value of each phase, and the value obtained by subtracting the average from the voltage command value of each phase is used as the modulation wave. As a result, the maximum amplitude of the modulation wave is multiplied by  $\sqrt{3}/2$ , while voltage utilization becomes 100% and line voltage is unchanged.

$$\begin{pmatrix} V'_u \\ V'_v \\ V'_w \end{pmatrix} = \begin{pmatrix} V_u \\ V_v \\ V_w \end{pmatrix} + \Delta V \begin{pmatrix} 1 \\ 1 \\ 1 \end{pmatrix}$$

$$\therefore \Delta V = -\frac{V_{max} + V_{min}}{2}, \quad V_{max} = \max\{V_u, V_v, V_w\}, \quad V_{min} = \min\{V_u, V_v, V_w\}$$

$V_u, V_v, V_w$ : Command values of U-, V-, and W-phases

$V'_u, V'_v, V'_w$ : Command values of U-, V-, and W-phases for PWM generation (modulation wave)

The modulation factor  $m$  is defined as follows.

$$m = \frac{V'}{E}$$

$m$ : Modulation ratio     $V'$ : Reference phase voltage for PWM  
 $E$ : Inverter input voltage

### 3.1.4 State transition

Figure 3-1 is a state transition diagram of the sensorless vector control software. In the target software of this application note, the software state is managed by “SYSTEM MODE”. Motor 1 and 2 are controlled in the same method.

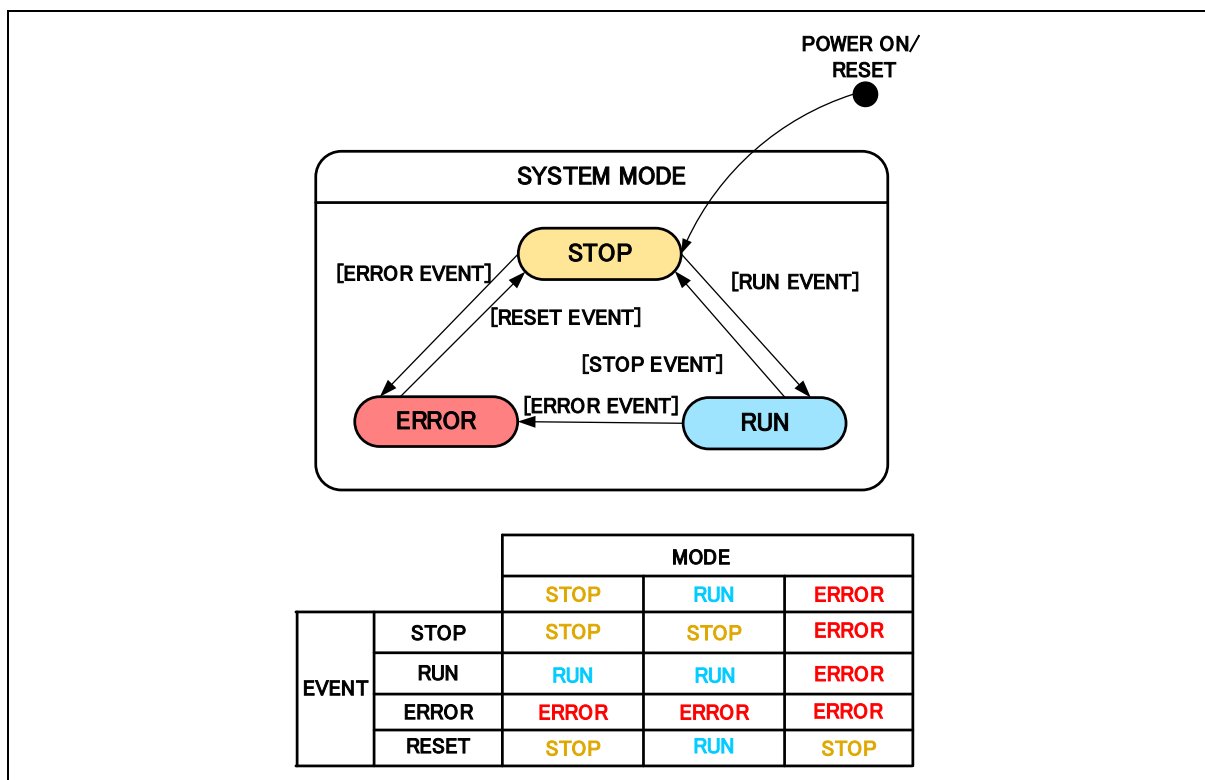

Figure 3-1 State Transition Diagram of Sensorless Vector Control Software

(1). SYSTEM MODE

“SYSTEM MODE” indicates the operating states of the system. The state transits on occurrence of each event (EVENT). “SYSTEM MODE” has 3 states that are motor drive stop (INACTIVE), motor drive (ACTIVE), and abnormal condition (ERROR).

(2). EVENT

When “EVENT” occurs in each “SYSTEM MODE”, “SYSTEM MODE” changes as shown the table in Table 3-4, according to that “EVENT”. The occurrence factors of each event are shown below.

Table 3-4 List of EVENT

EVENT name	occurrence factor
STOP	by user operation
RUN	by user operation
ERROR	when the system detects an error
RESET	by user operation

### 3.1.5 Start-up method

Figure 3-2 shows startup control of sensorless vector control software. Each mode is controlled by flags managing each reference of the d-axis current, q-axis current, and speed.

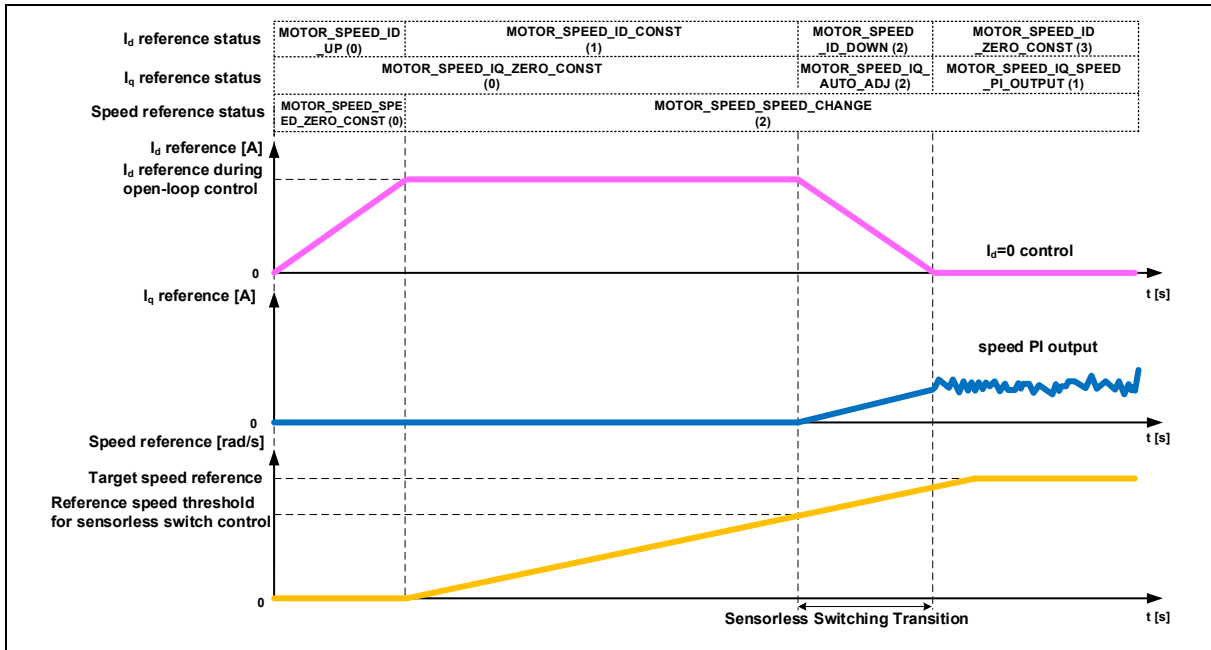

Figure 3-2 Startup Control of Sensorless Vector Control Software

### 3.1.6 System protection function

This control software has the following error status and executes emergency stop functions in case of occurrence of respective errors. Table 3-5 shows each software threshold for the system protection function.

#### - Over current error

There are two kind of overcurrent protection.

Hardware OCP: When emergency stop signal from the hardware is detected, PWM output ports are automatically set to high impedance output (without software intervention).

Software OCP: U, V, and W phase currents are monitored in over current monitoring cycle. When an over current is detected, the CPU executes emergency stop.

#### - Over voltage error

The inverter bus voltage is monitored in over voltage monitoring cycle. When an over voltage is detected (when the voltage exceeds the over voltage limit), the CPU performs emergency stop. Here, the over voltage limit is set in consideration of the error of resistance value of the detect circuit. When this error occurs, the CPU performs emergency stop in the side of the motor in which the error occurred.

#### - Low voltage error

The inverter bus voltage is monitored in low-voltage monitoring cycle. The CPU performs emergency stop when low voltage (when voltage falls below the limit) is detected. Here, the low voltage limit is set in consideration of the error of resistance value of the detect circuit. When this error occurs, the CPU performs emergency stop in the side of the motor in which the error occurred.

#### - Over speed error

The rotation speed is monitored in rotation speed monitoring cycle. The CPU performs emergency stop when the speed is over the limit. When this error occurs, the CPU performs emergency stop in the side of the motor in which the error occurred.

**Table 3-5 Setting Values of the System Protection Function**

Error name	Threshold		Monitoring cycle
Over current error	Over current limit [A]	3.54	Current control
Over voltage error	Over voltage limit [V]	60	Current control
Low voltage error	Low voltage limit [V]	8	Current control
Over speed error	Speed limit [rpm]	4500	Current control

### 3.1.7 The method to measure phase currents with an 1shunt resistance

In the chapter, the method to measure phase currents using in this software is explained.

#### 3.1.7.1 The timing of measure phase currents

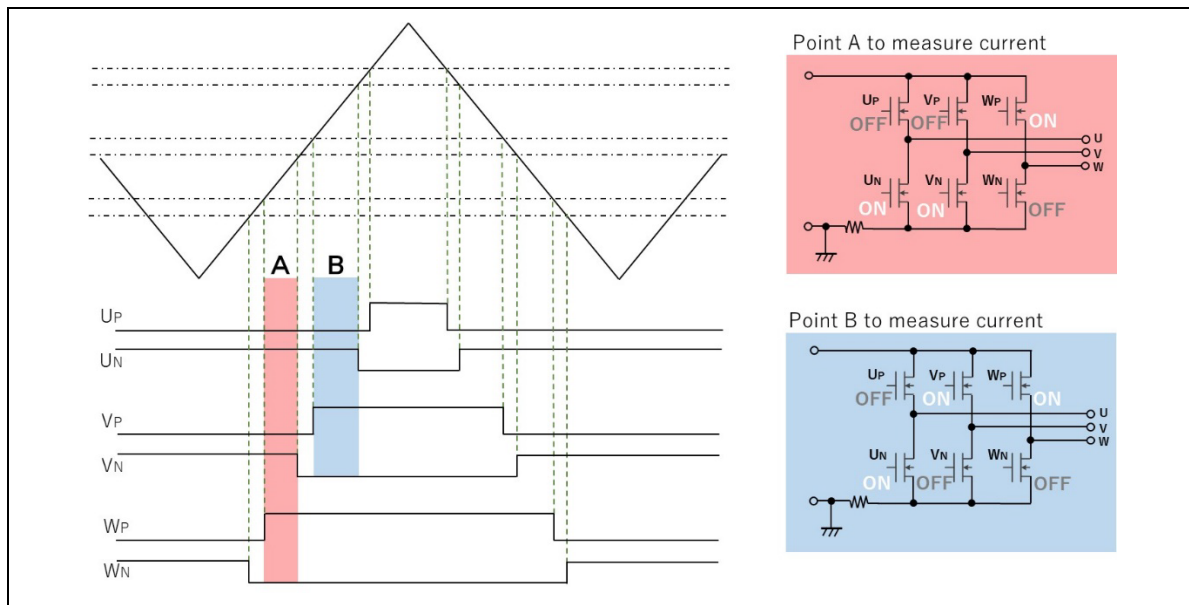

Figure 3-3 The wave form of PWM (in case of duty pattern  $W > V > U$ )

In this program, Triangle-wave PWM mode 3 is used to generate PWM wave with dead time by GPT unit. Figure 3-3 shows the wave form of PWM in case of duty pattern  $W > V > U$ .

At the point A in the figure, only W phase upper arm is ON as shown in the red rectangle in right side. In that case, the current which flows in the 1shunt resistance is same as current flows in W phase.

At the point B in the figure, only U phase low arm is ON as shown in the blue rectangle. In that case, the current which flows in the 1shunt resistance is same as current flows in U phase.

The remained V phase current can be calculated with these phase currents by the first theory of Kirchoff. Therefore, the three phase currents can be measured with measurement of point A and B.

The case which is shown in Figure 3-3 is the duty pattern  $W > V > U$ . Six duty pattern will be performed with each phase PWM output. The currents which be measured in point A and B changes according to duty pattern, so it is necessary to assign calculated currents to each phase. The assignment is possible, because each phase relations can be known at each PWM duty calculation.

**Table 3-6 Relation between Duty pattern and phase current**

Duty pattern	Point A	Point B
$W > V > U$	$I_w$	$-I_u$
$W > U > V$	$I_w$	$-I_v$
$V > W > U$	$I_v$	$-I_u$
$V > U > W$	$I_v$	$-I_w$
$U > W > V$	$I_u$	$-I_v$
$U > V > W$	$I_u$	$-I_w$

### 3.1.7.2 Shunt resistance current measurement method using RA6T2 function

When measuring the current with one shunt resistor as shown in 3.1.7.1, it is necessary to control the conversion timing of the A / D converter according to the PWM duty setting. In the sample software, this is realized by GTADTRA of RA6T2 GPT module and A / D conversion start request function by compare match of GTADTRB register and GTCNT counter.

g_timer0 Timer, General PWM (r_gpt)		
Settings	Property	Value
API Info	▼ Common	
	Parameter Checking	Default (BSP)
	Pin Output Support	Enabled with Extra Features
	Write Protect Enable	Disabled
	Clock Source	PCLKD
	▼ Module g_timer0 Timer, General PWM (r_gpt)	
	▼ General	
	Name	g_timer0
	Channel	4
	Mode	Triangle-Wave Asymmetric PWM (Mode 3)
	Period	100
	Period Unit	Microseconds
	▼ Output	
	> Custom Waveform	
	Duty Cycle Percent (only applicable in PWM mode)	50
	GTIOCA Output Enabled	True
	GTIOCA Stop Level	Pin Level Low
	GTIOCB Output Enabled	True
	GTIOCB Stop Level	Pin Level High
	> Input	
	▼ Interrupts	
	Callback	rm_motor_driver_1shunt_cyclic
	Overflow/Crest Interrupt Priority	Priority 8
	Capture A Interrupt Priority	Disabled
	Capture B Interrupt Priority	Disabled
	Underflow/Trough Interrupt Priority	Disabled
	▼ Extra Features	
	> Output Disable	
	▼ ADC Trigger	
	▼ Start Event Trigger (GPTE/GPTEH only)	
	Trigger Event A/D Converter Start Request A Dur	<input checked="" type="checkbox"/>
	Trigger Event A/D Converter Start Request A Dur	<input type="checkbox"/>
	Trigger Event A/D Converter Start Request B Dur	<input checked="" type="checkbox"/>
	Trigger Event A/D Converter Start Request B Dur	<input type="checkbox"/>
	> Dead Time	
	> ADC Trigger (GPTE/GPTEH only)	
	> Interrupt Skipping (GPTE/GPTEH only)	
	Extra Features	Enabled

Figure 3-4 GPT ADC trigger setting

### 3.1.7.3 Duty adjustment

If the timing as shown in 3.1.7.1 can be secured, the current can be detected by one shunt resistor, but sufficient time for A / D conversion cannot be secured depending on the PWM duty setting conditions during operation. Therefore, the current value cannot be obtained correctly. The following two measures are implemented for the conditions where timing cannot be secured.

(1) When the switching timings of the two phases are close to each other

When the switching timings of the two phases are close to each other and the time for A / D conversion cannot be secured, the PWM duty is not changed and the phase switching timing to be switched later is required for A / D conversion. The conversion time is secured by shifting only.

(2) When timing shift is not possible

If the PWM switching timing is delayed as described above, the duty is wide, and if the end of the PWM carrier cycle is reached, the timing cannot be delayed. In such a case, the modulation factor is close to 1, so the modulation factor is limited so that the PWM switching timing is at the end of the carrier cycle.

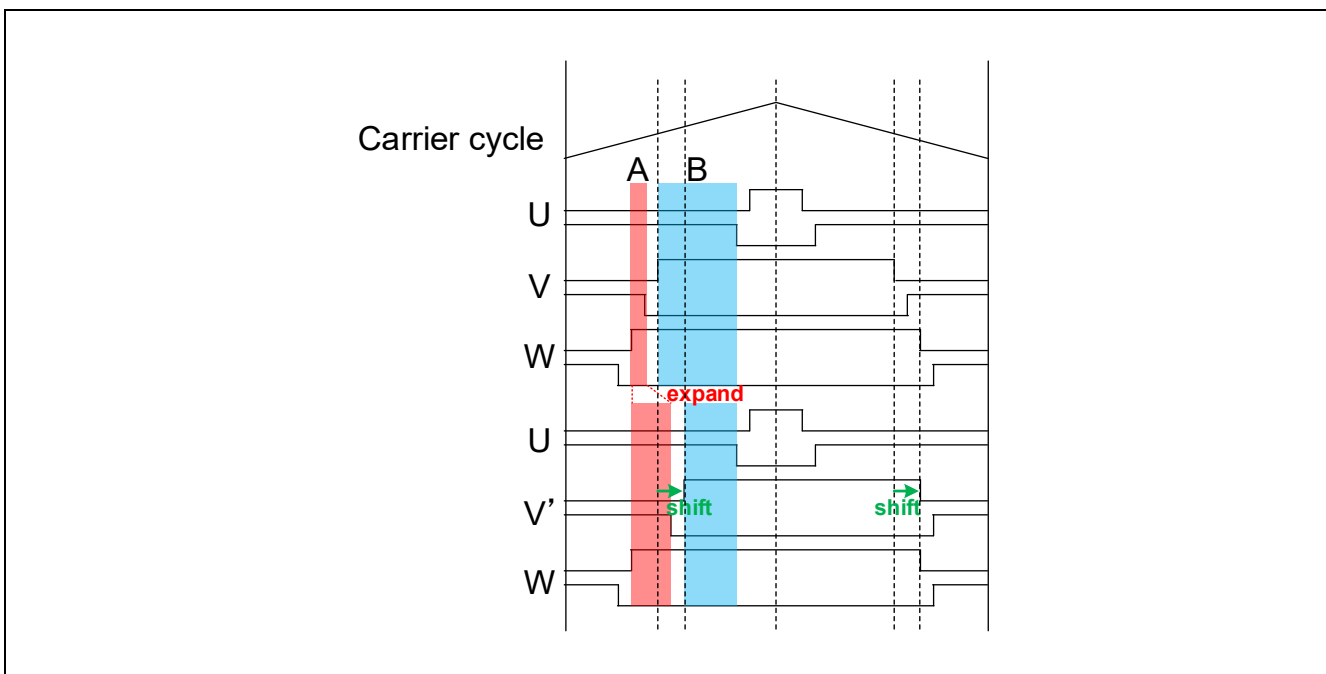

Figure 3-5 Duty adjustment



### 3.1.8 AD triggers

Shows the timing of AD triggers and scan groups.

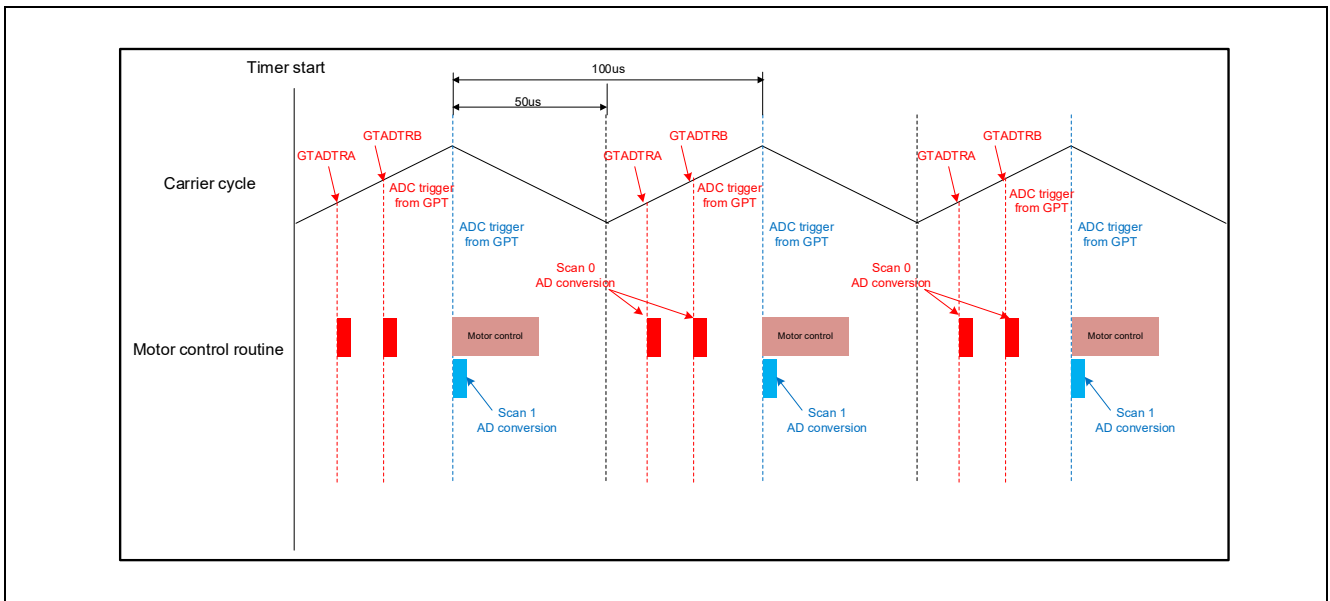

Figure 3-6 AD trigger timing

### 3.2 Function specifications of sensorless vector control software

The block diagram of sensorless vector control is shown below.

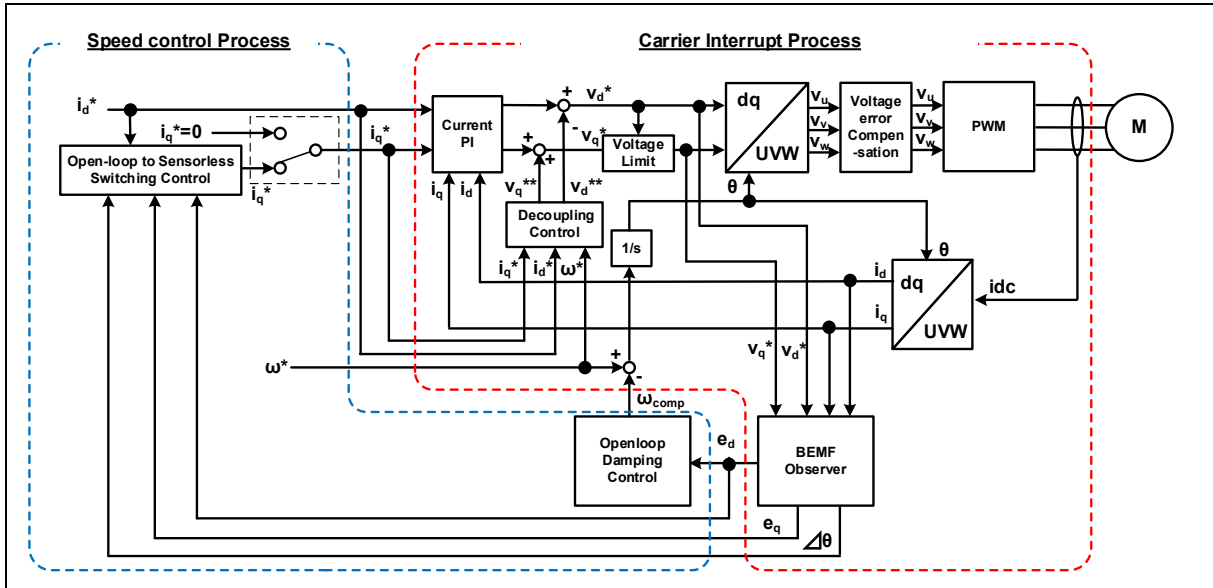

Figure 3-7 Block Diagram of Sensorless Vector Control (Openloop Control)

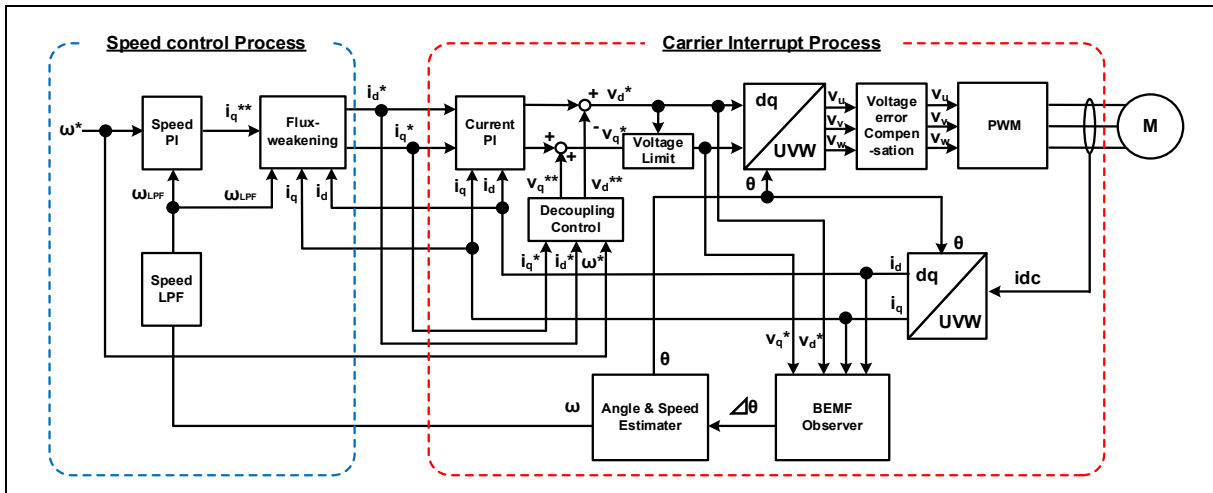

Figure 3-8 Block Diagram of Sensorless Vector Control (Sensorless Control)

**Table 3-7 List of Functions Executed in Current Control Period Interrupt (1/4)**

File name	Function name	Process overview
mtr_main.c	mtr_callback_event Input : (motor_callback_args_t *) p_args / Callback argument Output : None	Sensorless control callback function
rm_motor_sensorless.c	rm_motor_sensorless_current_callback Input : (motor_current_callback_args_t *) p_args / Callback argument Output :None	Set the speed control output to the current control input
	RM_MOTOR_SENSORLESS_ErrorCheck Input : (motor_ctrl_t * const) p_ctrl / Pointer to control structure. (uint16_t * const) p_error / Pointer to get occurred error Output : fsp_err_t / Execution result	Check the occurrence of Error.
	rm_motor_sensorless_copy_speed_current Input : (motor_speed_output_t *) st_output / Pointer to the structure of Speed Control output (motor_current_input_t *) st_input / Pointer to the structure of Current Control input Output :None	Copy speed output data to current input data
rm_motor_driver.c	rm_motor_driver_1shunt_cyclic Input : ((timer_callback_args_t *) p_args / Callback argument Output :None	Motor driver callback function
	rm_motor_driver_1shunt_current_get Input : (motor_driver_instance_ctrl_t *) p_ctrl / The pointer to the motor driver module instance Output :None	Get A/D converted data (Phase Current with 1shunt resistance & Main Line Voltage)
	RM_MOTOR_DRIVER_FlagCurrentOffsetGet Input : (motor_driver_ctrl_t * const) p_ctrl / Pointer to control structure (uint8_t * const) p_flag_offset / Flag of finish current offset detection Output : fsp_err_t / Execution result	Measure current offset values
	RM_MOTOR_DRIVER_PhaseVoltageSet Input : (motor_driver_ctrl_t * const) p_ctrl / Pointer to control structure (float const) u_voltage / U phase voltage (float const) v_voltage / V phase voltage (float const) w_voltage / W phase voltage Output : fsp_err_t / Execution result	Set Phase Voltage Data to calculate PWM duty.

**Table 3-8 List of Functions Executed in Current Control Period Interrupt (2/4)**

File name	Function name	Process overview
rm_motor_driver.c	rm_motor_driver_1shunt_modulation Input : (motor_driver_instance_ctrl_t *) p_ctrl / The pointer to the motor driver module instance Output :None	Perform PWM modulation (included duty pattern judgement)
	rm_motor_driver_mod_run Input : (motor_driver_instance_ctrl_t *) p_ctrl / Pointer to Motor Driver instance (const float *) p_f4_v_in / Pointer to the 3-phase input voltage (float *) p_f4_duty_out / Where to store the 3-phase output duty cycle Output :None	Calculates duty cycle from input 3-phase voltage (bipolar)
	rm_motor_driver_set_uvw_duty Input : (motor_driver_instance_ctrl_t *) p_ctrl / Pointer to Motor Driver instance (float) f_duty_u / The duty cycle of Phase-U (float) f_duty_v / The duty cycle of Phase-V (float) f_duty_w / The duty cycle of Phase-W Output : fsp_err_t / Execution result	PWM duty setting
	RM_MOTOR_DRIVER_CurrentGet Input : (motor_driver_ctrl_t * const) p_ctrl / Pointer to control structure (motor_driver_current_get_t * const) p_current_get / Pointer to get data structure Output : fsp_err_t / Execution result	Get calculated phase Current, Vdc & Va_max data
rm_motor_current.c	rm_motor_current_cyclic Input : (motor_driver_callback_args_t *) p_args / Callback argument Output :None	Current control cycle operation
	RM_MOTOR_CURRENT_ParameterSet Input : (motor_current_ctrl_t * const) p_ctrl / Pointer to control structure (motor_current_input_t const * const) p_st_input / Pointer to input data structure Output : fsp_err_t / Execution result	Set (Input) Parameter Data.
	RM_MOTOR_CURRENT_CurrentSet Input : (motor_current_ctrl_t * const) p_ctrl / Pointer to control structure (motor_current_input_current_t const * const) p_st_current / Pointer to input current structure (motor_current_input_voltage_t const * const) p_st_voltage / Pointer to input voltage structure Output : fsp_err_t / Execution result	Set d/q-axis Current & Voltage Data.
	RM_MOTOR_CURRENT_CurrentGet Input : (motor_current_ctrl_t * const) p_ctrl / Pointer to control structure (float * const) p_id / Pointer to get d-axis current (float * const) p_iq / Pointer to get q-axis current Output : fsp_err_t / Execution result	Get d/q-axis Current.
	motor_current_transform_uvw_dq_abs Input : (const float) f_angle / rotor angle (const float *) f_uvw / the pointer to the UVW-phase array in [U,V,W] format (float *) f_dq / where to store the [d,q] formatted array on dq coordinates Output :None	Coordinate transform UVW to dq (absolute transform)

**Table 3-9 List of Functions Executed in Current Control Period Interrupt (3/4)**

File name	Function name	Process overview
rm_motor_current.c	motor_current_angle_cyclic Input : (motor_current_instance_t *) p_instance / The pointer to current control module control instance Output :None	Angle/Speed Process in Cyclic Process of Current Control
	RM_MOTOR_CURRENT_SpeedPhaseSet Input : (motor_current_ctrl_t * const) p_ctrl / Pointer to control structure (float const) speed / Rotational speed (float const) phase / Rotor phase Output : fsp_err_t / Execution result	Set Current Speed & rotor phase Data.
	RM_MOTOR_CURRENT_CurrentReferenceSet Input : (motor_current_ctrl_t * const) p_ctrl / Pointer to control structure (float const) id_reference / D-axis current Reference (float const) iq_reference / Q-axis current Reference Output : fsp_err_t / Execution result	Set Current Reference Data
	RM_MOTOR_CURRENT_PhaseVoltageGet Input : (motor_current_ctrl_t * const) p_ctrl / Pointer to control structure (motor_current_get_voltage_t * const) p_voltage / Pointer to get Voltages Output : fsp_err_t / Execution result	Gets the set phase voltage.
	motor_current_pi_calculation Input : (motor_current_instance_ctrl_t *) p_ctrl / The pointer to the FOC current control structure Output :None	Calculates the output voltage vector from current vector command and actual current vector
	motor_current_pi_control Input : (motor_current_pi_params_t *) pi_ctrl / The pointer to the PI control structure Output : float / PI control output value	PI control
	motor_current_limit_abs Input : (float) f4_value / Target value (float) f4_limit_value / Limit Output : float / Limited value	Limit with absolute value
	motor_current_decoupling Input : (motor_current_instance_ctrl_t *) p_ctrl / The pointer to the FOC current control instance (float) f_speed_rad / The electrical speed (const motor_current_motor_parameter_t *) p_mtr / The pointer to the motor parameter data structure Output :None	Decoupling control
	motor_current_voltage_limit Input : (motor_current_instance_ctrl_t *) p_ctrl / The pointer to the FOC current control structure Output :None	Limit voltage vector

**Table 3-10 List of Functions Executed in Current Control Period Interrupt (4/4)**

File name	Function name	Process overview
rm_motor_current.c	motor_current_transform_dq_uvw_abs Input : (const float) f_angle / Rotor angle (const float *) f_dq / The pointer to the dq-axis value array in [D,Q] format f_uvw / Where to store the [U,V,W] formatted 3-phase quantities array (float *) Output :None	Coordinate transform dq to UVW 3-phase (absolute transform)
librm_motor_current.a	rm_motor_voltage_error_compensation_main Input : (motor_currnt_voltage_compensation_t *) st_volt_comp / Voltage error compensation data (float *) p_f4_v_array / Reference voltage (float *) p_f4_i_array / Reference current (float) f4_vdc / Bus voltage Output :None	Voltage error compensation
rm_motor_estimate.c	RM_MOTOR_ESTIMATE_FlagPiCtrlSet Input : (motor_angle_ctrl_t * const) p_ctrl / Pointer to control structure (uint32_t const) flag_pi / The flag of PI control runs Output : fsp_err_t / Execution result	Set the flag of PI Control runs.
	RM_MOTOR_ESTIMATE_SpeedSet Input : (motor_angle_ctrl_t * const) p_ctrl / Pointer to control structure (float const) speed_ctrl / Control reference of rotational speed (float const) damp_speed / Damping rotational speed Output : fsp_err_t / Execution result	Set Speed Information
	RM_MOTOR_ESTIMATE_CurrentSet Input : (motor_angle_ctrl_t * const) p_ctrl / Pointer to control structure (motor_angle_current_t * const) p_st_current / Pointer to current structure (motor_angle_voltage_reference_t * const) p_st_voltage / Pointer to voltage Reference structure Output : fsp_err_t / Execution result	Set d/q-axis Current Data & Voltage Reference.
	RM_MOTOR_ESTIMATE_AngleSpeedGet Input : (motor_angle_ctrl_t * const) p_ctrl / Pointer to control structure (float * const) p_angle / Memory address to get rotor angle data (float * const) p_speed / Memory address to get rotational speed data (float * const) p_phase_err / Memory address to get phase(angle) error data Output : fsp_err_t / Execution result	Gets the current rotor's angle and rotation speed.
	RM_MOTOR_ESTIMATE_EstimatedComponentGet Input : (motor_angle_ctrl_t * const) p_ctrl / Pointer to control structure (float * const) p_ed / Memory address to get estimated d-axis component (float * const) p_eq / Memory address to get estimated q-axis component Output : fsp_err_t / Execution result	Gets estimated d/q-axis component.
r_gpt_three_phase.c	R_GPT_THREE_PHASE_DutyCycleSet Input : (three_phase_ctrl_t * const) p_ctrl / Control block set in @ref three_phase_api_t::open call for this timer (three_phase_duty_cycle_t * const) p_duty_cycle / Duty cycle values for all three timer channels Output : fsp_err_t / Execution result	Sets duty cycle for all three timers.

**Table 3-11 List of Functions Executed in Speed Control Interrupt(1/2)**

File name	Function name	Process overview
mtr_main.c	mtr_callback_event Input : (motor_callback_args_t *) p_args / Callback argument Output :None	Sensorless control callback function
	get_vr1 Input :None Output : uint16_t / conversion value	Get VR1 A/D conversion value
rm_motor_current.c	RM_MOTOR_CURRENT_ParameterGet Input : (motor_current_ctrl_t * const) p_ctrl / Pointer to control structure (motor_current_output_t * const) p_st_output / Pointer to output data structure Output : fsp_err_t / Execution result	Get speed control input data from current control
rm_motor_sensorless.c	rm_motor_sensorless_speed_callback Input : (motor_speed_callback_args_t *) p_args / Callback argument Output :None	Speed control callback function
	rm_motor_sensorless_copy_current_speed Input : (motor_current_output_t *) st_output / Pointer to the structure of Current Control output (motor_speed_input_t *) st_input / Pointer to the structure of Speed Control input Output :None	Copy current output data to speed input data
rm_motor_speed.c	rm_motor_speed_cyclic Input : (timer_callback_args_t *) p_args/ Callback argument Output :None	Cyclic process of Speed Control (Call at timer interrupt)
	RM_MOTOR_SPEED_ParameterSet Input : (motor_speed_ctrl_t * const) p_ctrl / Pointer to control structure (motor_speed_input_t const * const) p_st_input / Pointer to structure to input parameters Output : fsp_err_t / Execution result	Set speed Input parameters
	RM_MOTOR_SPEED_SpeedControl Input : (motor_speed_ctrl_t * const) p_ctrl / Pointer to control structure Output : fsp_err_t / Execution result	Calculates the d/q-axis current reference.(Main process of Speed Control)
	rm_motor_speed_set_speed_ref Input : (motor_speed_instance_ctrl_t *) p_ctrl / The pointer to the FOC data instance Output : float / Speed reference	Updates the speed reference
	rm_motor_speed_set_iq_ref Input : (motor_speed_instance_ctrl_t *) p_ctrl / The pointer to the ctrl instance Output : float / Iq reference	Updates the q-axis current reference
	rm_motor_speed_set_id_ref Input : (motor_speed_instance_ctrl_t *) p_ctrl / The pointer to the ctrl instance Output : float / Id reference	Updates the d-axis current reference
	RM_MOTOR_SPEED_ParameterGet Input : (motor_speed_ctrl_t * const) p_ctrl / The pointer to the ctrl instance (motor_speed_output_t * const) p_st_output / Pointer to get speed control parameters Output : fsp_err_t / Execution result	Get speed control output parameters

**Table 3-12 List of Functions Executed in Speed Control Interrupt(2/2)**

File name	Function name	Process overview
librm_motor_speed.a	rm_motor_speed_first_order_lpf Input : (motor_speed_lpf_t *) p_lpf / First order LPF structure (float) f4_omega / Natural frequency (float) f4_ctrl_period / Control period Output : None	First Order LPF
	rm_motor_speed_fluxwkn_set_vamax Input : (motor_speed_flux_weakening_t *) p_fluxwkn / The pointer to flux weakening structure (float) f4_va_max / maximum magnitude of voltage vector Output :None	Sets the maximum magnitude of voltage vector
	rm_motor_speed_fluxwkn_run Input : (motor_speed_flux_weakening_t *) p_fluxwkn / The pointer to flux weakening structure (float) f4_speed_rad / The electrical speed of motor (const float *) p_f4_idq / The pointer to the measured current vector in format d/q (float *) p_f4_idq_ref / The pointer to the reference current vector in format d/q Output :None	Executes the flux-weakening module



### 3.3 Contents of control

#### 3.3.1 Configuration Options

The configuration options of the sensorless vector control module for motor can be configured using the RA Configurator. The changed options are automatically reflected to the hal\_data.c when generating code. The option names and setting values are listed in the Table 3-13 shown as follows.

**Table 3-13 Configuration Options (rm\_motor\_sensorless.h)**

Options	Description
Limit of over current (A)	When a phase current exceeds this value, PWM output ports are set to off.
Limit of over voltage (V)	When an inverter voltage exceeds this value, PWM output ports are set to off.
Limit of over speed (rpm)	When a rotation speed exceeds this value, PWM output ports are set to off.
Limit of low voltage (V)	When an inverter voltage becomes below this value, PWM output ports are set to off.

**Table 3-14 Configuration Options initial value(rm\_motor\_sensorless.h)**

Options	RA6T2	RA4T1	RA6T3	RA8T1
Limit of over current (A)	1.67	1.67	1.67	1.67
Limit of over voltage (V)	60.0	60.0	60.0	60.0
Limit of over speed (rpm)	4500.0	4500.0	4500.0	4500.0
Limit of low voltage (V)	8.0	8.0	8.0	8.0

#### 3.3.2 Configuration Options for included modules

The sensorless vector control module for motor includes below modules.

- Current Module
- Speed Module
- Angle Module
- Driver Module

And these included modules have each configuration parameters as same as the sensorless vector control module. The option names and setting values are listed in the tables shown as follows.

**Table 3-15 Configuration Options for Current Control**

<b>Configuration Options (rm_motor_current.h)</b>	
<b>Options</b>	<b>Description</b>
General   Shunt type	Selects how many shunt resistances to use current detection.
General   Current control decimation	Counts of decimation about carrier interrupt
General   PWM carrier frequency (kHz)	PWM carrier frequency [kHz]
General   Input voltage (V)	Input voltage [V]
General   Sample delay compensation	Selects whether to “enable” or “disable” sample delay compensation
General   Period magnification value	Period magnification value for sampling delay compensation.
General   Voltage error compensation	Selects whether to “enable” or “disable” voltage error compensation.
General   Voltage error compensation table of voltage 1	Table of voltage error compensation about voltage #1
General   Voltage error compensation table of voltage 2	Table of voltage error compensation about voltage #2
General   Voltage error compensation table of voltage 3	Table of voltage error compensation about voltage #3
General   Voltage error compensation table of voltage 4	Table of voltage error compensation about voltage #4
General   Voltage error compensation table of voltage 5	Table of voltage error compensation about voltage #5
General   Voltage error compensation table of current 1	Table of voltage error compensation about current #1
General   Voltage error compensation table of current 2	Table of voltage error compensation about current #2
General   Voltage error compensation table of current 3	Table of voltage error compensation about current #3
General   Voltage error compensation table of current 4	Table of voltage error compensation about current #4
General   Voltage error compensation table of current 5	Table of voltage error compensation about current #5
Design Parameter   Current PI loop omega	Current PI control omega parameter [Hz].
Design Parameter   Current PI loop zeta	Current PI control zeta parameter.
Motor Parameter   Pole pairs	Pole pairs of target motor.
Motor Parameter   Resistance (ohm)	Resistance of motor [ohm].
Motor Parameter   Inductance of d-axis (H)	D-axis inductance [H].
Motor Parameter   Inductance of q-axis (H)	Q-axis inductance [H].
Motor Parameter   Permanent magnetic flux (Wb)	Magnetic flux [Wb].
Motor Parameter   Rotor inertia (kgm <sup>2</sup> )	Rotor inertia [kgm <sup>2</sup> ].

**Table 3-16 Configuration Options initial value(rm\_motor\_current.h)**

Options	RA6T2	RA4T1	RA6T3	RA8T1
General   Shunt type	1shunt	1shunt	1shunt	1shunt
General   Current control decimation	0	1	0	0
General   PWM carrier frequency (kHz)	10.0	10.0	10.0	10.0
General   Input voltage (V)	24.0	24.0	24.0	24.0
General   Sample delay compensation	Disable	Disable	Disable	Disable
General   Period magnification value	1.5	1.5	1.5	1.5
General   Voltage error compensation	Enable	Enable	Enable	Enable
General   Voltage error compensation table of voltage 1	0.477	0.477	0.477	0.477
General   Voltage error compensation table of voltage 2	0.742	0.742	0.742	0.742
General   Voltage error compensation table of voltage 3	0.892	0.892	0.892	0.892
General   Voltage error compensation table of voltage 4	0.979	0.979	0.979	0.979
General   Voltage error compensation table of voltage 5	1.009	1.009	1.009	1.009
General   Voltage error compensation table of current 1	0.021	0.021	0.021	0.021
General   Voltage error compensation table of current 2	0.034	0.034	0.034	0.034
General   Voltage error compensation table of current 3	0.064	0.064	0.064	0.064
General   Voltage error compensation table of current 4	0.158	0.158	0.158	0.158
General   Voltage error compensation table of current 5	0.400	0.400	0.400	0.400
Design Parameter   Current PI loop omega	300.0	300.0	300.0	300.0
Design Parameter   Current PI loop zeta	1.0	1.0	1.0	1.0
Motor Parameter   Pole pairs	4	4	4	4
Motor Parameter   Resistance (ohm)	1.3	1.3	1.3	1.3
Motor Parameter   Inductance of d-axis (H)	0.0013	0.0013	0.0013	0.0013
Motor Parameter   Inductance of q-axis (H)	0.0013	0.0013	0.0013	0.0013
Motor Parameter   Permanent magnetic flux (Wb)	0.01119	0.01119	0.01119	0.01119
Motor Parameter   Rotor inertia (kgm <sup>2</sup> )	0.000003666	0.000003666	0.000003666	0.000003666

**Table 3-17 Configuration Options for Speed Control**

Configuration Options (rm_motor_speed.h)	
Options	Description
Common   Position support	Support position control
General   Speed control period (sec)	The period of speed control process [sec].
General   Step of speed climbing (rpm)	The step of speed fluctuation [rpm]. Program controls speed by this step at acceleration and deceleration.
General   Maximum rotational speed (rpm)	Maximum rotational speed [rpm]
General   Speed LPF omega	Speed LPF parameter omega [Hz].
General   Limit of q-axis current (A)	Limit of q-axis current [A].
General   Step of speed feedback at open-loop	Rate of reference speed for feedback speed limiter at Open-Loop.
General   Natural frequency	Natural frequency for disturbance speed observer.
General   Open-loop damping	Select enable/disable of damping control at Open-Loop.
General   Flux weakening	Select enable/disable of flux weakening control at high speed.
General   Torque compensation for sensorless transition	Select enable/disable of soft switching at the transition from Open-Loop to PI control.
General   Speed observer	Select enable/disable of speed observer process
General   Selection of speed observer	Select the method of speed observer
General   Control method	Select the position control method.
Open-Loop   Step of d-axis current climbing	The d-axis current reference ramping up rate [A/msec].
Open-Loop   Step of d-axis current descending	The d-axis current reference ramping down rate [A/msec].
Open-Loop   Step of q-axis current descending ratio	The q-axis current reference ramping down proportion to reference before open-loop [A/msec].
Open-Loop   Reference of d-axis current	The d-axis current reference in open-loop drive [A].
Open-Loop   Threshold of speed control descending	The speed threshold [rad/s] to ramp down the d-axis current [rpm].
Open-Loop   Threshold of speed control climbing	The speed threshold [rad/s] to ramp up the d-axis current [rpm].
Open-Loop   Period between open-loop to BEMF (sec)	Time to switch open-loop to sensor-less [sec].
Open-Loop   Phase error(degree) to decide sensor-less switch timing	Phase error to decide sensor-less switch timing (electrical angle) [degree].
Design parameter   Speed PI loop omega	Speed PI Control parameter omega.
Design parameter   Speed PI loop zeta	Speed PI Control parameter zeta.
Design parameter   Estimated d-axis HPF omega	Natural frequency [Hz] for HPF in open-loop damping gain design.
Design parameter   Open-loop damping zeta	Damping ratio for open-loop damping gain design.
Design parameter   Cutoff frequency of phase error LPF	The cut-off frequency [Hz] of phase error LPF gain design.
Design parameter   Speed observer omega	Speed observer omega.
Design parameter   Speed observer zeta	Speed observer zeta.
Motor Parameter   Pole pairs	Pole pairs of target motor.
Motor Parameter   Resistance (ohm)	Resistance of motor [ohm].
Motor Parameter   Inductance of d-axis (H)	D-axis inductance [H].
Motor Parameter   Inductance of q-axis (H)	Q-axis inductance [H].
Motor Parameter   Permanent magnetic flux (Wb)	Magnetic flux [Wb].
Motor Parameter   Rotor inertia (kgm <sup>2</sup> )	Rotor inertia [kgm <sup>2</sup> ].

**Table 3-18 Configuration Options initial value(rm\_motor\_speed.h)**

Options	RA6T2	RA4T1	RA6T3	RA8T1
Common   Position support	-	-	-	-
General   Speed control period (sec)	0.001	0.002	0.001	0.001
General   Step of speed climbing (rpm)	0.5	2.0	0.5	0.5
General   Maximum rotational speed (rpm)	2400	2400.0	2400.0	2400.0
General   Speed LPF omega	10.0	10.0	10.0	10.0
General   Limit of q-axis current (A)	1.67	1.67	1.67	1.67
General   Step of speed feedback at open-loop	0.2	0.2	0.2	0.2
General   Natural frequency	100.0	100.0	100.0	100.0
General   Open-loop damping	Enable	Enable	Enable	Enable
General   Flux weakening	Disable	Disable	Disable	Disable
General   Torque compensation for sensorless transition	Enable	Enable	Enable	Enable
General   Speed observer	Disable	Disable	Disable	Disable
General   Selection of speed observer	Normal	Normal	Normal	Normal
General   Control method	-	-	-	-
Open-Loop   Step of d-axis current climbing	0.6	1.2	0.6	0.6
Open-Loop   Step of d-axis current descending	0.6	1.2	0.6	0.6
Open-Loop   Step of q-axis current descending ratio	1.0	1.0	1.0	1.0
Open-Loop   Reference of d-axis current	0.3	0.3	0.3	0.3
Open-Loop   Threshold of speed control descending	700	700	700	700
Open-Loop   Threshold of speed control climbing	500	500	500	500
Open-Loop   Period between open-loop to BEMF (sec)	0.025	0.025	0.025	0.025
Open-Loop   Phase error(degree) to decide sensor-less switch timing	10	10	10	10
Design parameter   Speed PI loop omega	3.0	3.0	3.0	3.0
Design parameter   Speed PI loop zeta	1.0	1.0	1.0	1.0
Design parameter   Estimated d-axis HPF omega	2.5	2.5	2.5	2.5
Design parameter   Open-loop damping zeta	1.0	1.0	1.0	1.0
Design parameter   Cutoff frequency of phase error LPF	10.0	10.0	10.0	10.0
Design parameter   Speed observer omega	-	-	-	-
Design parameter   Speed observer zeta	-	-	-	-
Motor Parameter   Pole pairs	4	4	4	4
Motor Parameter   Resistance (ohm)	1.3	1.3	1.3	1.3
Motor Parameter   Inductance of d-axis (H)	0.0013	0.0013	0.0013	0.0013
Motor Parameter   Inductance of q-axis (H)	0.0013	0.0013	0.0013	0.0013
Motor Parameter   Permanent magnetic flux (Wb)	0.01119	0.01119	0.01119	0.01119
Motor Parameter   Rotor inertia (kgm <sup>2</sup> )	0.000003666	0.000003666	0.000003666	0.000003666

**Table 3-19 Configuration Options for Angle and Speed Estimation**

Configuration Options (rm_motor_estimate.h)		
Options	Description	
Motor Parameter   Pole pairs	Pole pairs of target motor.	
Motor Parameter   Resistance (ohm)	Resistance of motor [ohm].	
Motor Parameter   Inductance of d-axis (H)	D-axis inductance [H].	
Motor Parameter   Inductance of q-axis (H)	Q-axis inductance [H].	
Motor Parameter   Permanent magnetic flux (Wb)	Magnetic flux [Wb].	
Motor Parameter   Rotor inertia (kgm <sup>2</sup> )	Rotor inertia [kgm <sup>2</sup> ].	
Motor Parameter   Nominal current (Arms)	Nominal current [Arms]	
Openloop damping	Select enable/disable of Open-Loop Damping Control	
Natural frequency of BEMF observer	Natural frequency for BEMF observer [Hz].	
Damping ratio of BEMF observer	Damping ratio for BEMF observer.	
Natural frequency of PLL Speed estimate loop	Natural frequency for rotor position Phase-Locked Loop [Hz].	
Damping ratio of PLL Speed estimate loop	Damping ratio for rotor position Phase-Locked Loop.	
Control period	Period of Speed Control [sec]	

**Table 3-20 Configuration Options initial value(rm\_motor\_estimate.h)**

Options	RA6T2	RA4T1	RA6T3	RA8T1
Motor Parameter   Pole pairs	4	4	4	4
Motor Parameter   Resistance (ohm)	1.3	1.3	1.3	1.3
Motor Parameter   Inductance of d-axis (H)	0.0013	0.0013	0.0013	0.0013
Motor Parameter   Inductance of q-axis (H)	0.0013	0.0013	0.0013	0.0013
Motor Parameter   Permanent magnetic flux (Wb)	0.01119	0.01119	0.01119	0.01119
Motor Parameter   Rotor inertia (kgm <sup>2</sup> )	0.000003666	0.000003666	0.000003666	0.000003666
Motor Parameter   Nominal current (Arms)	1.67	1.67	1.67	1.67
Openloop damping	Enable	Enable	Enable	Enable
Natural frequency of BEMF observer	1000.0	500.0	1000.0	1000.0
Damping ratio of BEMF observer	1.0	1.0	1.0	1.0
Natural frequency of PLL Speed estimate loop	20.0	20.0	20.0	20.0
Damping ratio of PLL Speed estimate loop	1.0	1.0	1.0	1.0
Control period	0.0001	0.0002	0.0001	0.0001

**Table 3-21 Configuration Options for Driver Access**

Configuration Options (rm_motor_driver.h)		
Options		Description
Common	ADC_B Support	ADC_B module support
Common	Shared ADC support	Selection of using shared ADC module
Common	Supported Motor Number	Number of driven motors
General	Shunt type	Current detection method selection
General	Modulation method	Selection of the method of modulation
General	PWM output port UP	Port setting of U phase upper arm
General	PWM output port UN	Port setting of U phase lower arm
General	PWM output port VP	Port setting of V phase upper arm
General	PWM output port VN	Port setting of V phase lower arm
General	PWM output port WP	Port setting of W phase upper arm
General	PWM output port WN	Port setting of W phase lower arm
General	PWM Timer Frequency (MHz)	PWM Timer Clock Frequency [MHz]
General	PWM Carrier Period (Microseconds)	PWM Carrier Period [Micro seconds]
General	Dead Time (Raw Counts)	PWM Dead time [raw counts]
General	Current Range (A)	Measurement Range of Electric current [A]
General	Voltage Range (V)	Measurement Range of Inverter Voltage [V]
General	Counts for current offset measurement	Counts of measurement the offset of A/D Conversion at electric current input.
General	A/D conversion channel for U Phase current	A/D channel for U-phase current
General	A/D conversion channel for W Phase current	A/D channel for W-phase current
General	A/D conversion channel for Main Line Voltage	A/D channel for main line voltage
General	A/D conversion channel for V Phase current	A/D channel for V-phase current
General	A/D conversion channel for sin signal	A/D channel for sin signal
General	A/D conversion channel for cos signal	A/D channel for cos signal
General	Using ADC scan group	Set ADC scan group according to ADC module setting.
General	A/D conversion unit for U Phase current	Select the A/D conversion module for U phase current
General	A/D conversion unit for W Phase current	Select the A/D conversion module for W phase current
General	A/D conversion unit for main line voltage	Select the A/D conversion module for main line voltage
General	A/D conversion unit for V Phase current	Select the A/D conversion module for V phase current
General	A/D conversion unit for sin signal	Select the A/D conversion module for sin signal
General	A/D conversion unit for cos signal	Select the A/D conversion module for cos signal
General	ADC interrupt module	Select from which module ADC interrupt happens
General	Adjustment value to current A/D	Current A/D timing adjustment (for 1shunt)
General	Minimum difference of PWM duty	Minimum difference of PWM duty setting (for 1shunt)
General	Adjustment delay of A/D conversion	A/D conversion delay timing adjustment (for 1shunt)
General	1shunt interrupt phase	Which phase is used to detect 1shunt current (for 1shunt)
General	Input Voltage (V)	Range of input for main line voltage
General	Resolution of A/D conversion	Resolution of A/D conversion Please set same value with ADC module setting.
General	Offset of A/D conversion for current	Offset level of A/D conversion input for current Please set according to the circuit.
General	Conversion level of A/D conversion for voltage	Conversion level of A/D conversion for voltage Please set when the CPU main voltage is different.
General	GTIOCA stop level	Output level of upper arm at stop status
General	GTIOCB stop level	Output level of lower arm at stop status
Modulation	Maximum duty	Maximum duty of PWM Maximum duty except dead time.

**Table 3-22 Configuration Options initial value(rm\_motor\_driver.h)[1/2]**

Options	RA6T2	RA4T1	RA6T3	RA8T1
Common   ADC_B Support	Enabled	-	-	-
Common   Shared ADC support	Disabled	Disabled	Disabled	Enabled
Common   Supported Motor Number	1	1	1	1
General   Shunt type	1shunt	1shunt	1shunt	1shunt
General   Modulation method	SVPWM	SVPWM	SVPWM	SVPWM
General   PWM output port UP	BSP_IO_PORT_11_PIN_04	BSP_IO_PORT_04_PIN_09	BSP_IO_PORT_04_PIN_09	BSP_IO_PORT_01_PIN_15
General   PWM output port UN	BSP_IO_PORT_11_PIN_05	BSP_IO_PORT_04_PIN_08	BSP_IO_PORT_04_PIN_08	BSP_IO_PORT_06_PIN_09
General   PWM output port VP	BSP_IO_PORT_11_PIN_06	BSP_IO_PORT_01_PIN_03	BSP_IO_PORT_01_PIN_03	BSP_IO_PORT_01_PIN_13
General   PWM output port VN	BSP_IO_PORT_11_PIN_07	BSP_IO_PORT_01_PIN_02	BSP_IO_PORT_01_PIN_02	BSP_IO_PORT_01_PIN_14
General   PWM output port WP	BSP_IO_PORT_11_PIN_08	BSP_IO_PORT_01_PIN_11	BSP_IO_PORT_01_PIN_11	BSP_IO_PORT_03_PIN_00
General   PWM output port WN	BSP_IO_PORT_11_PIN_09	BSP_IO_PORT_01_PIN_12	BSP_IO_PORT_01_PIN_12	BSP_IO_PORT_01_PIN_12
General   PWM Timer Frequency (MHz)	120.0	100.0	100.0	120.0
General   PWM Carrier Period (Microseconds)	100.0	100.0	100.0	100.0
General   Dead Time (Raw Counts)	240	200	200	240
General   Current Range (A)	16.5	16.5	16.5	16.5
General   Voltage Range (V)	73.26	73.26	73.26	73.26
General   Counts for current offset measurement	500	500	500	500
General   A/D conversion channel for U Phase current	4	0	0	-
General   A/D conversion channel for W Phase current	-	-	-	-
General   A/D conversion channel for Main Line Voltage	6	4	4	8
General   A/D conversion channel for V Phase current	-	-	-	1
General   A/D conversion channel for sin signal	-	-	-	-
General   A/D conversion channel for cos signal	-	-	-	-
General   Using ADC scan group	0	-	-	-



**Table 3-23 Configuration Options initial value(rm\_motor\_driver.h)[2/2]**

Options	RA6T2	RA4T1	RA6T3	RA8T1
General   A/D conversion unit for U Phase current	-	0	0	-
General   A/D conversion unit for W Phase current	-	-	-	-
General   A/D conversion unit for main line voltage	-	0	0	0
General   A/D conversion unit for V Phase current	-	-	-	0
General   A/D conversion unit for sin signal	-	-	-	-
General   A/D conversion unit for cos signal	-	-	-	-
General   ADC interrupt module	-	1st	1st	1st
General   Adjustment value to current A/D	0.0	20.0	20.0	20.0
General   Minimum difference of PWM duty	900	500	500	500
General   Adjustment delay of A/D conversion	600	250	250	250
General   1shunt interrupt phase	PHASE_U	PHASE_U	PHASE_U	PHASE_V
General   Input Voltage (V)	24.0	24.0	24.0	24.0
General   Resolution of A/D conversion	0xFFF	0xFFF	0xFFF	0xFFF
General   Offset of A/D conversion for current	0x7FF	0x7FF	0x7FF	0x7FF
General   Conversion level of A/D conversion for voltage	1.0	1.0	1.0	1.0
General   GTIOCA stop level	Pin Level Low	Pin Level Low	Pin Level Low	Pin Level Low
General   GTIOCB stop level	Pin Level High	Pin Level High	Pin Level High	Pin Level High
Modulation   Maximum duty	0.9375	0.9375	0.9375	0.9375

### 3.4 Control flowcharts

#### 3.4.1 Main process

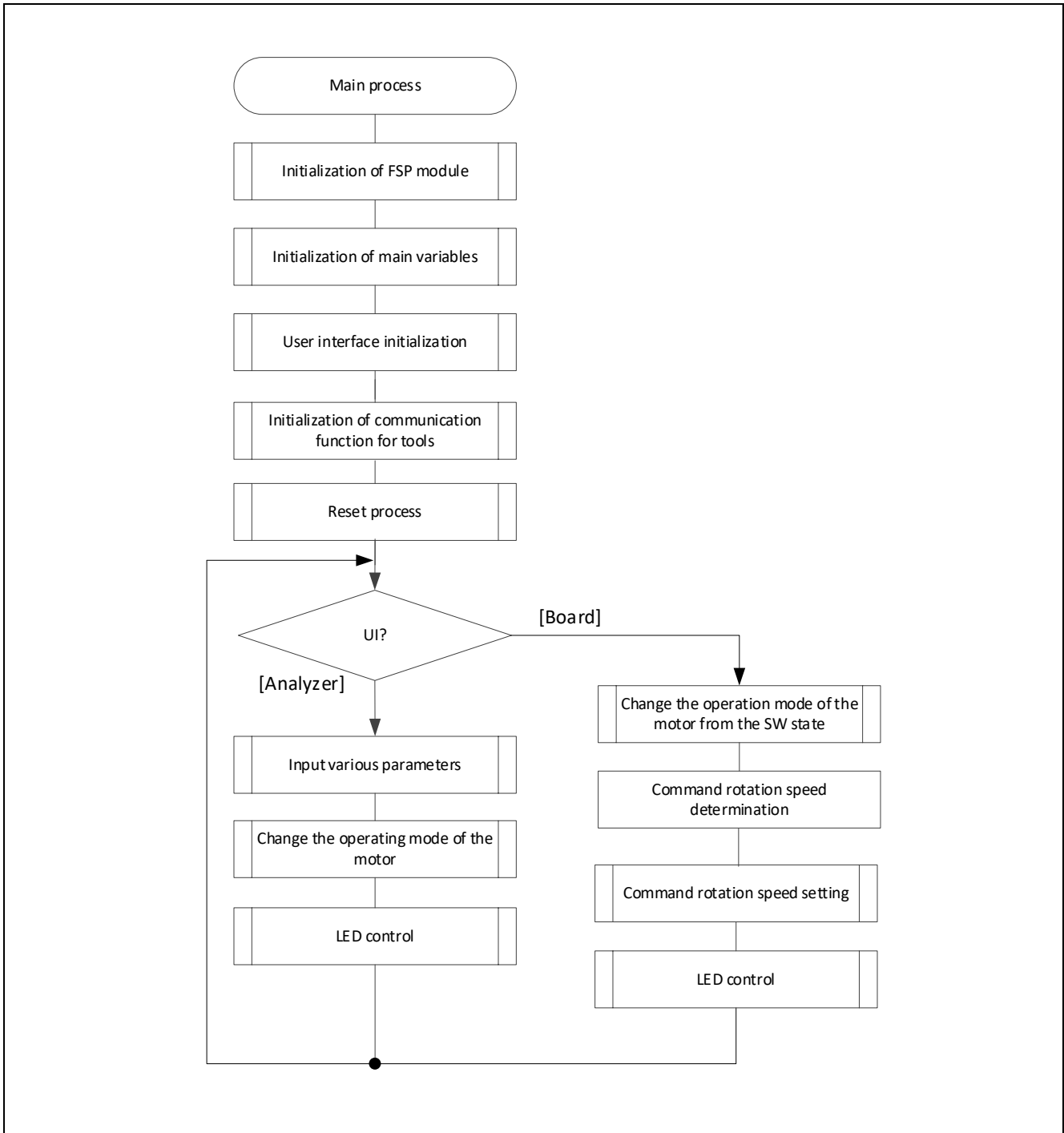

Figure 3-9 Main Process Flowchart

### 3.4.2 Current Control Period Interrupt (Carrier synchronized Interrupt) Process

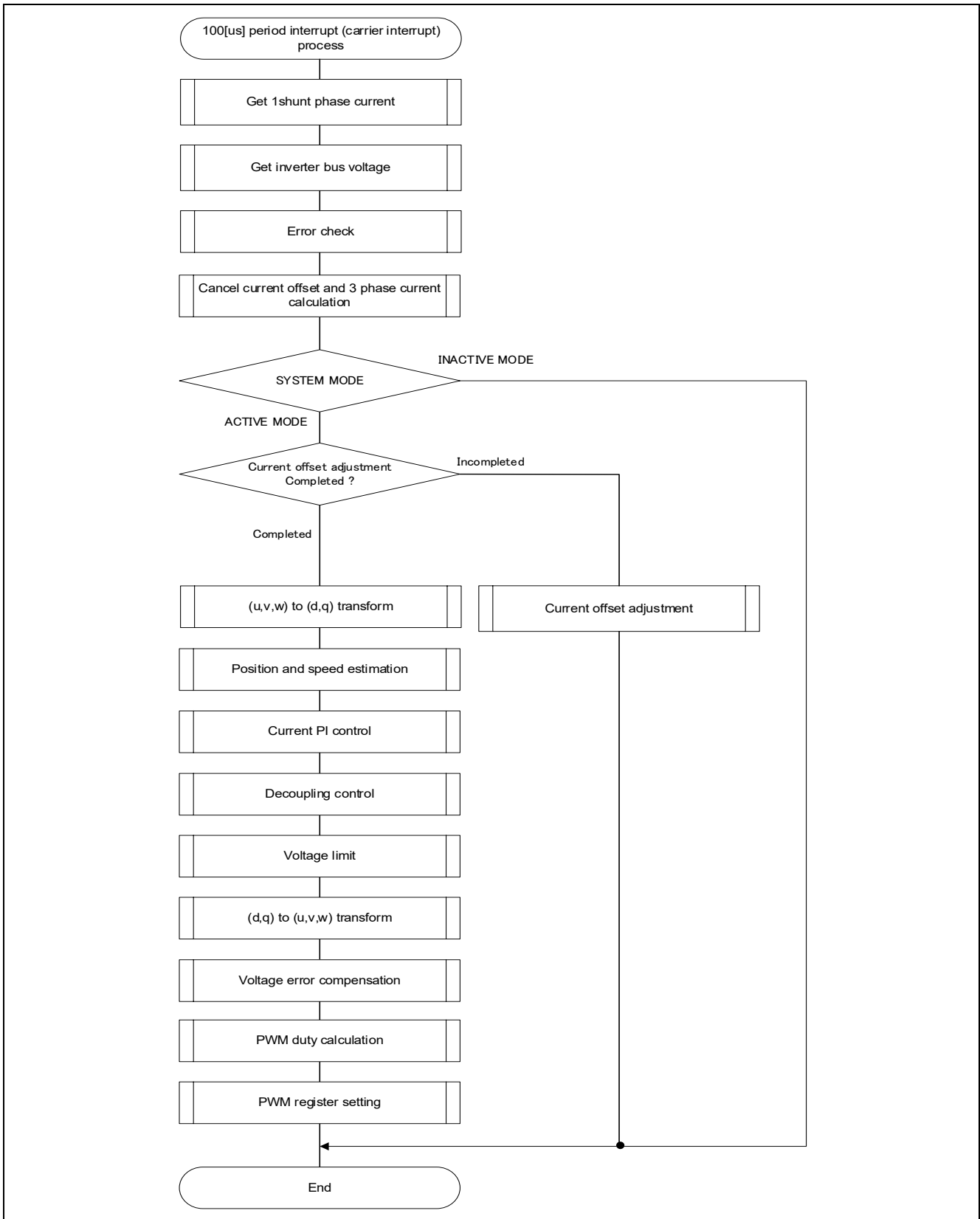

Figure 3-10 Current Control Period Interrupt (Carrier Interrupt) Process Flowchart

### 3.4.3 Speed Control Period Interrupt Process

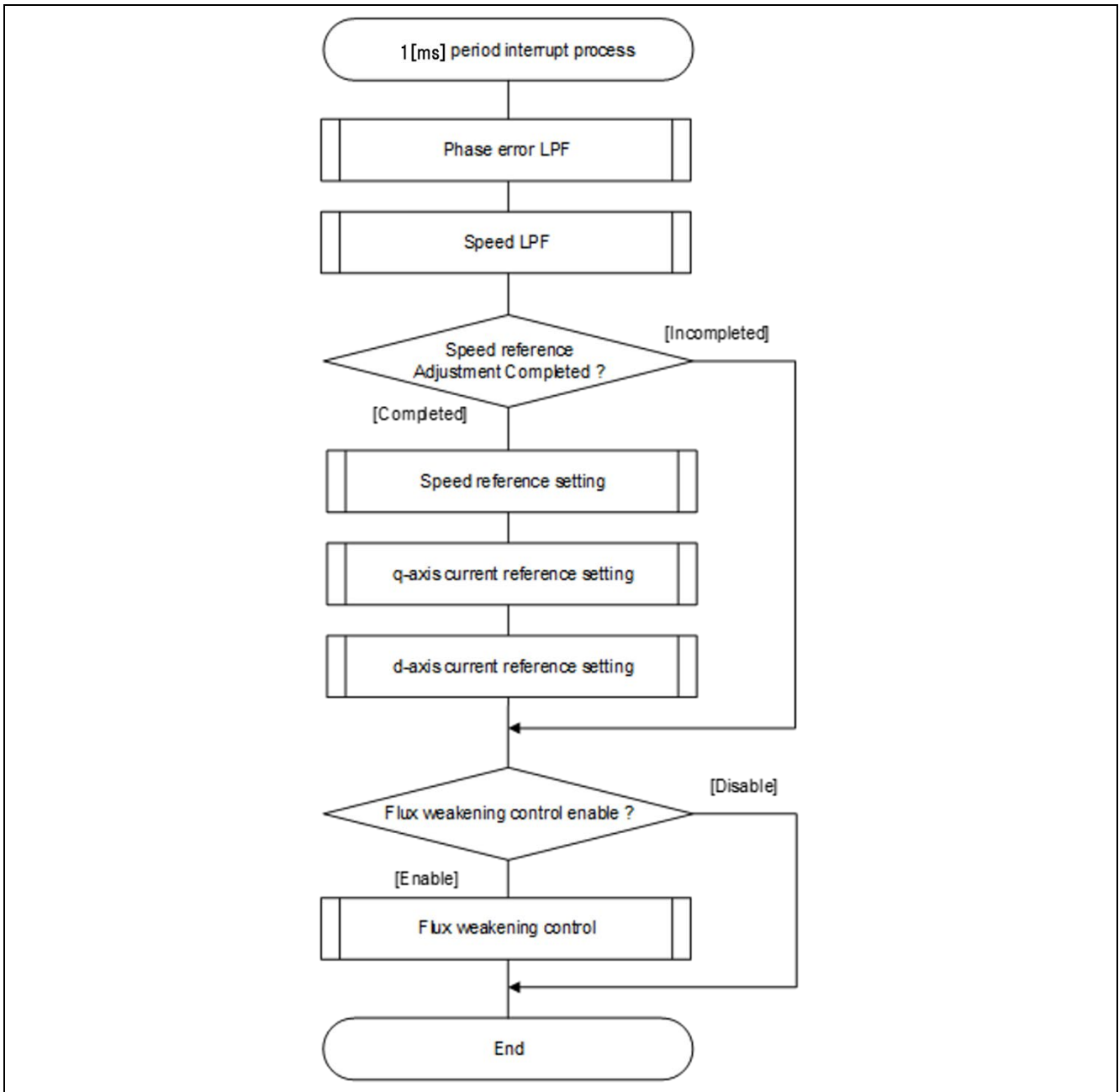

Figure 3-11 Speed Control Period Interrupt Process Flowchart

### 3.4.4 Over Current Detection Interrupt Process

The overcurrent detection interrupt is an interrupt that occurs when an external overcurrent detection signal is input. The PWM output terminal are put in the high impedance state. Therefore, at the start of execution of this interrupt processing, the PWM output terminal is already in the high impedance state and the output to the motor had been stopped.

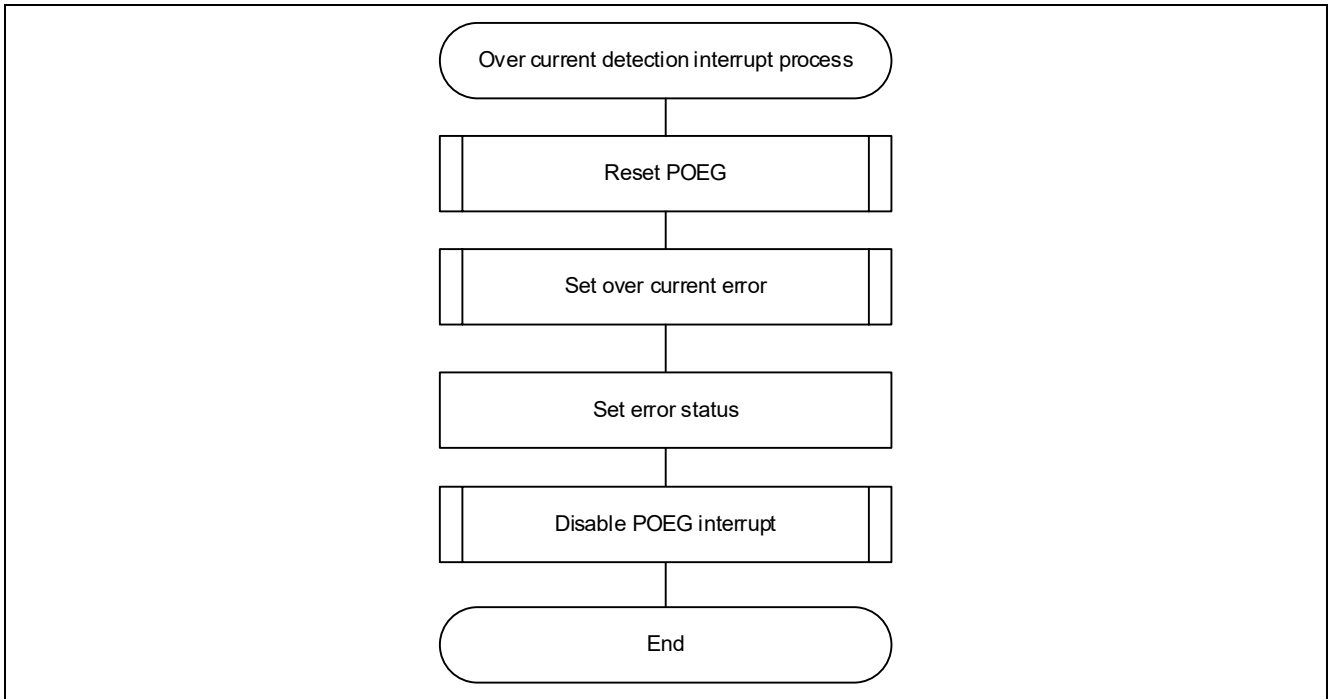

Figure 3-12 Over Current Detection Interrupt Process Flowchart

## 4. Evaluation environment explanation

### 4.1 Importing the Demo Project

The sample application provided with this document may be imported into e<sup>2</sup>studio using the steps in this section.

1. Select File → Import.

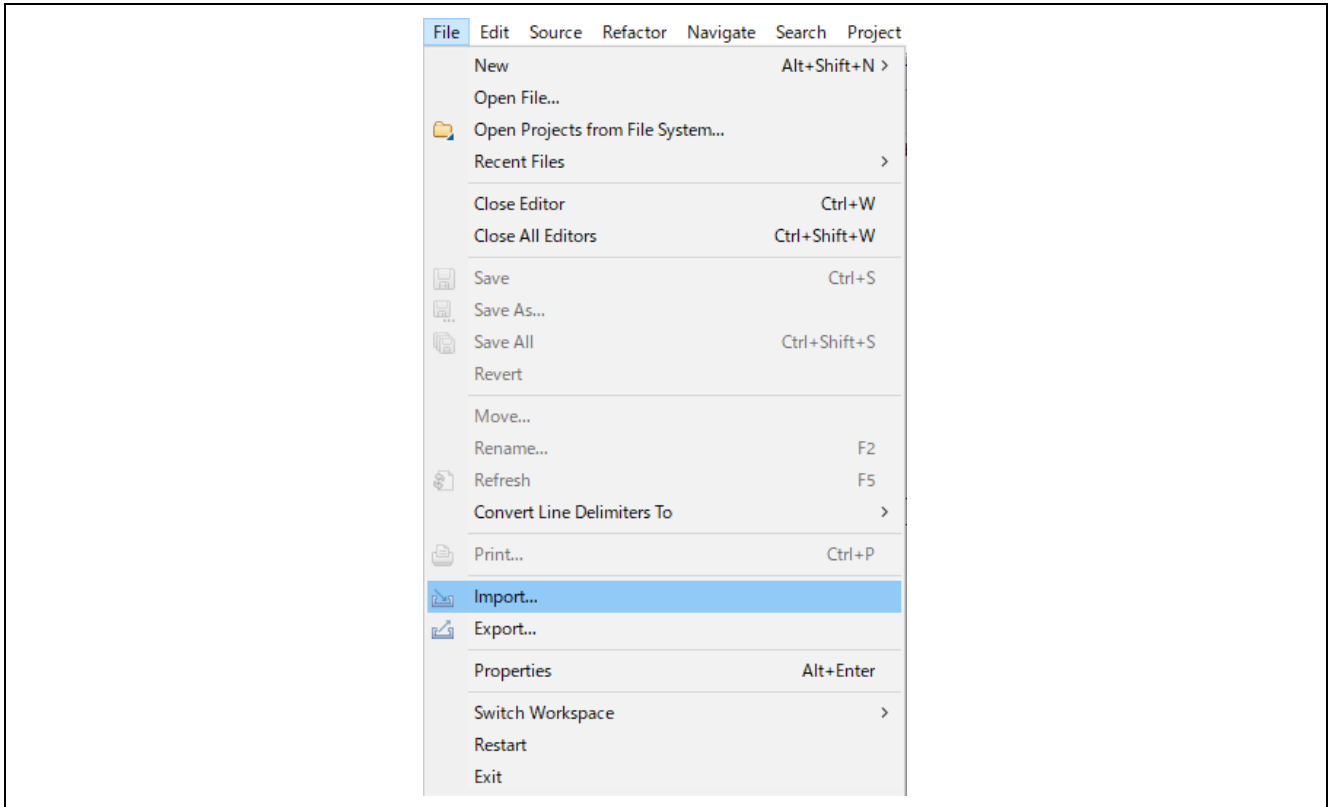

Figure 4-1 File Menu

2. Select “Existing Projects into Workspace”.

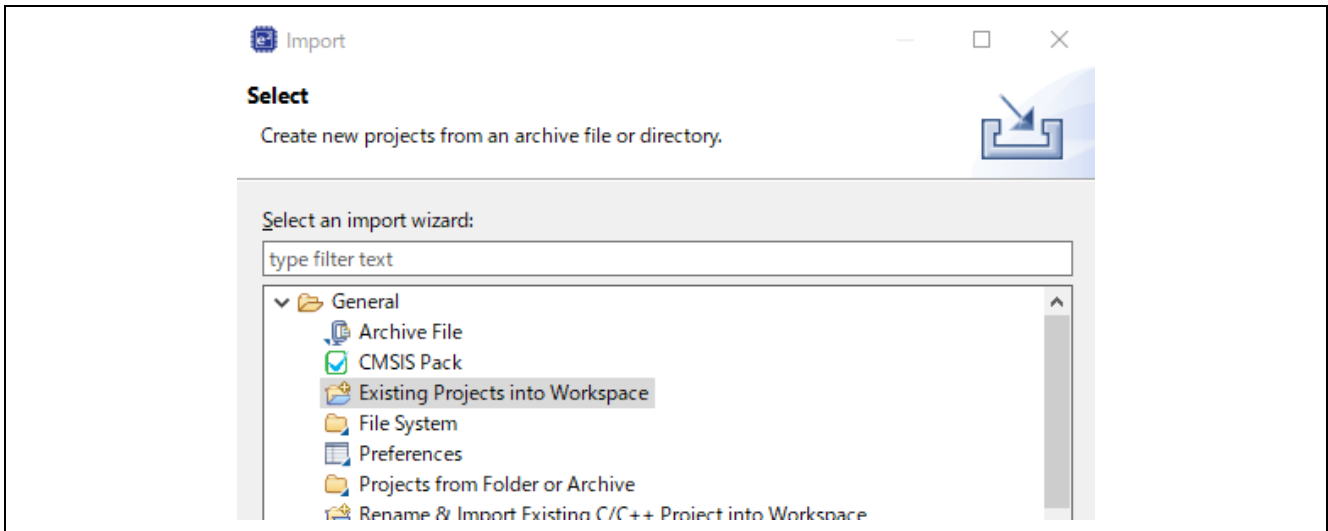

Figure 4-2 Import Wizard Selection

3. Click “Browse...” button and select the demo project. Click Finish button and the demo project is imported.

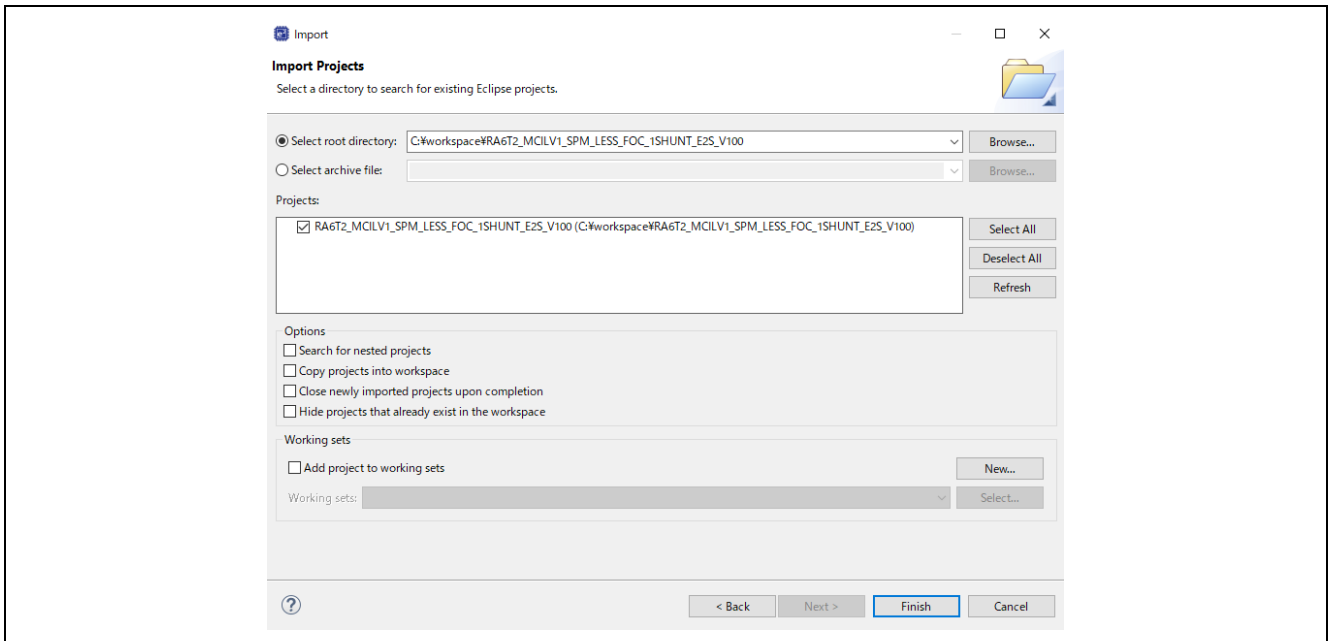

Figure 4-3 Import Projects

## 4.2 Building and Debugging

Refer to the "e<sup>2</sup>studio Getting Started Guide (R20UT4204)".

## 4.3 Motor Demonstration Project Overview

### 4.3.1 Quick Start

When executing the sample code only in the evaluation environment without using “Renesas Motor Workbench”, the Quick Start Sample Project can be executed with the following procedure.

- (1) After turning on stabilized power supply or executing reset, LED1 and LED2 on the inverter board are both off and the motor stops.
- (2) IF the toggle switch (SW1) on the inverter board is turned on, the motor starts to rotate. Every time the toggle switch (SW1) is changed, motor rotation starts/stops alternately. If the motor rotates normally, LED1 on the inverter board is on. However, if LED2 on the inverter board is also on, error is occurring.
- (3) In order to change the direction of the motor rotation, adjust it with the variable resistor (VR1) on the inverter board.
  - Turn the variable resistor (VR1) right: Rotate clockwise
  - Turn the variable resistor (VR1) left: Rotate counterclockwise
- (4) If error occurs, LED2 on the inverter board lightens, and the motor rotation stops. To restore, the toggle switch (SW1) on the inverter board needs to be turned off, the push switch (SW2) to be pushed and released.
- (5) In order to stop the operation check, turn off the output of the stabilized power supply after making sure that the motor rotation has already stopped.



## 4.4 Motor Control Development Support Tool ‘Renesas Motor Workbench’

### 4.4.1 Overview

In the target software of this application note, the motor control development support tool “Renesas Motor Workbench” is used as a user interface (rotating/stop motor, set rotation speed reference, etc). Please refer to ‘Renesas Motor Workbench User’s Manual’ for usage and more details.

You can find ‘Renesas Motor Workbench’ on Renesas Electronics Corporation website.

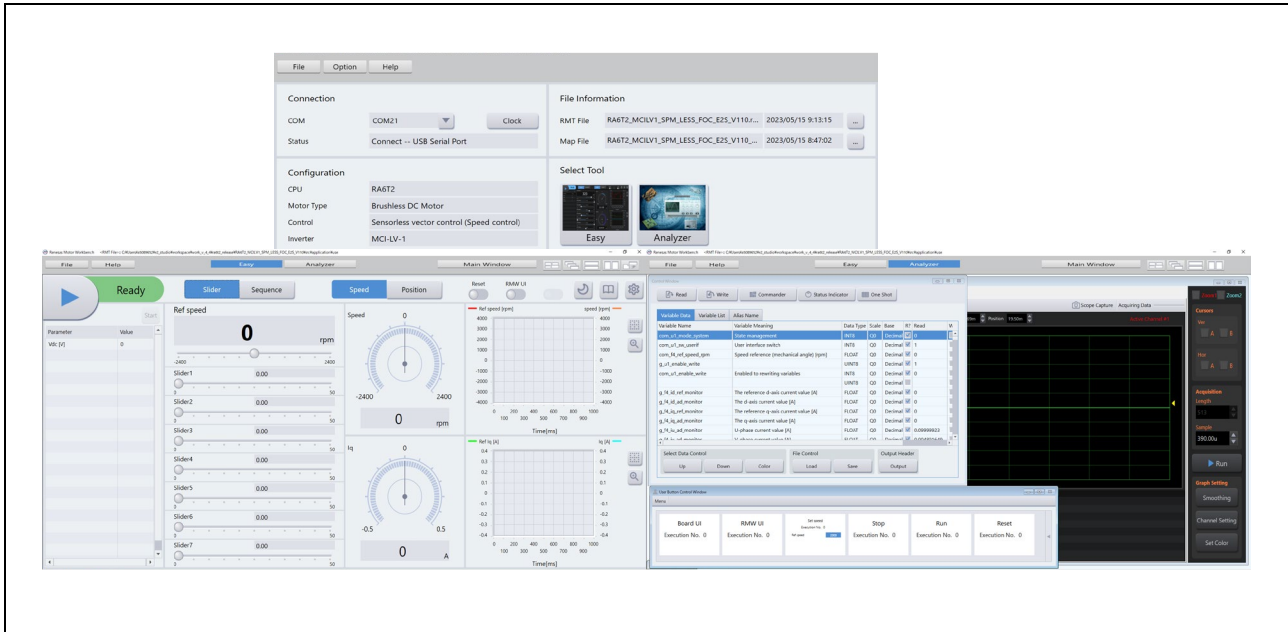
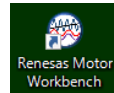

Figure 4-4 Renesas Motor Workbench – Appearance

### Set up for “Renesas Motor Workbench”



(1) Start ‘Renesas Motor Workbench’ by clicking this icon.

(2) Drop down menu [File] → [Open RMT File(O)].

And select RMT file in ‘[Project Folder]/src/application/user\_interface/ics/’.

(3) Use the ‘Connection’ [COM] select menu to choose the COM port.

(4) Click the Analyzer button of Select Tool to activate Analyzer function.

(5) Please refer to ‘4.5.2 Easy function operation example’ or ‘4.5.4 Operation Example for Analyzer’ for motor driving operation.

### 4.4.2 Easy function operation example

The following is an example of operating the motor using the Easy function.

- Change the user interface to use Renesas Motor Workbench
  - (1) Turn on "RMW UI".

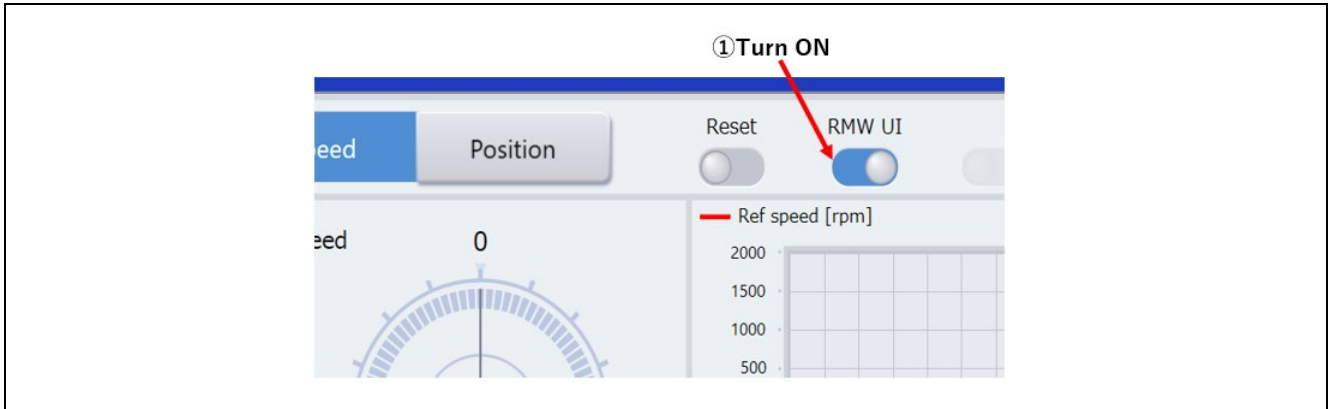

Figure 4-5 Procedure for changing to use Renesas Motor Workbench

- Change the user interface to use Renesas Motor Workbench
  - (1) Press the "Run" button

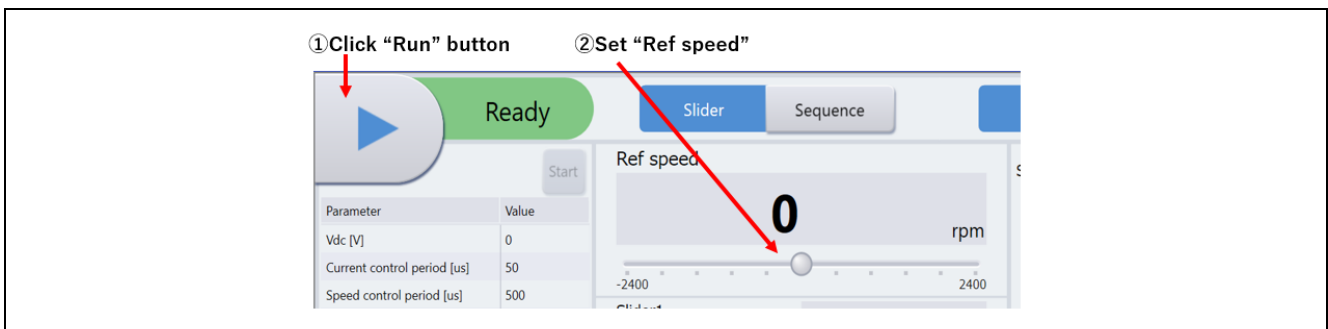

Figure 4-6 Motor rotation procedure

- Stop the motor
  - (1) Press the "Stop" button

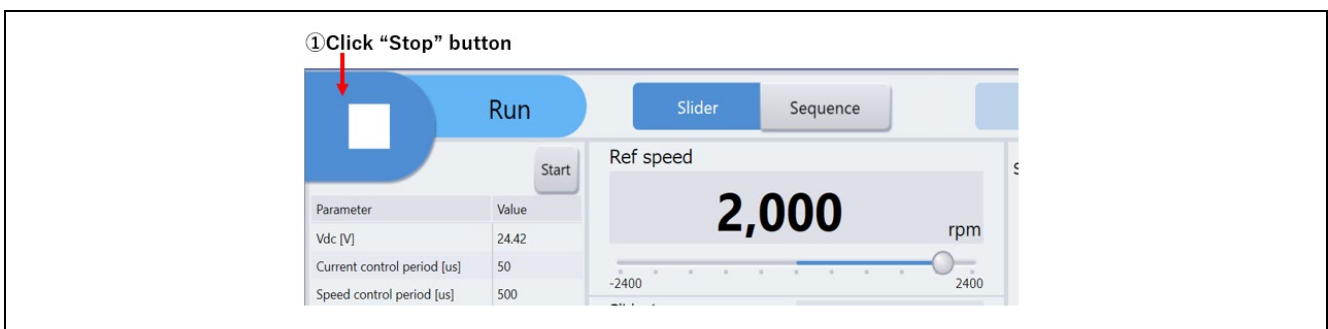

Figure 4-7 Motor stop procedure

- Processing when it stops (error)
  - (1) Turn on "Reset" button.
  - (2) Turn off "Reset" button

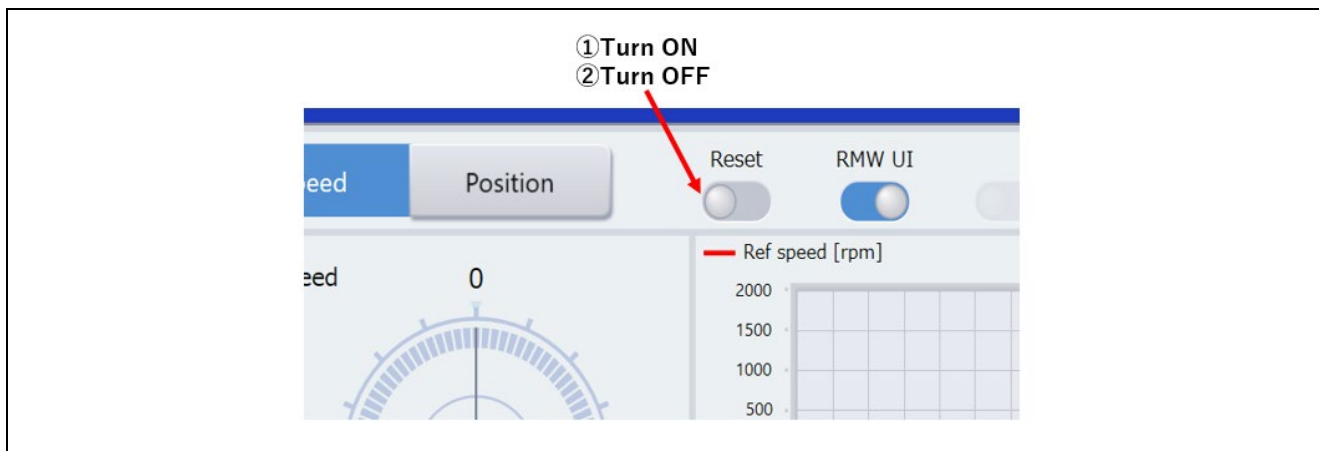

Figure 4-8 Error clearing procedure

### 4.4.3 List of variables for Analyzer function

Table 4-1 is a list of variables for Analyzer. These variables are reflected to the corresponding variables when the same values as g\_u1\_enable\_write are written to com\_u1\_enable\_write. However, note that variables with (\*) do not depend on com\_u1\_enable\_write.

**Table 4-1 List of Variables for Analyzer**

Variable name	Type	Content
com_u1_sw_userif (*)	uint8_t	User interface switch 0: Analyzer use 1: Board user interface use (default)
com_u1_mode_system(*)	uint8_t	State management 0: Stop mode 1: Run mode 3: Reset
com_f4_ref_speed_rpm	float	Speed reference (mechanical angle) [rpm]
com_u2_mtr_pp	uint16_t	Number of pole pairs
com_f4_mtr_r	float	Resistance [ $\Omega$ ]
com_f4_mtr_ld	float	d-axis Inductance [H]
com_f4_mtr_lq	float	q-axis Inductance [H]
com_f4_mtr_m	float	Magnetic Flux [Wb]
com_f4_mtr_j	float	Inertia [ $\text{kgm}^2$ ]
com_f4_current_omega	float	Natural frequency of current control system [Hz]
com_f4_current_zeta	float	Damping ratio of current control system
com_f4_speed_omega	float	Natural frequency of speed control system [Hz]
com_f4_speed_zeta	float	Damping ratio of speed control system
com_f4_e_obs_omega	float	Natural frequency of BEMF estimation system [Hz]
com_f4_e_obs_zeta	float	Damping ratio of BEMF estimation system
com_f4_pll_est_omega	float	Natural frequency of position estimation system [Hz]
com_f4_pll_est_zeta	float	Damping ratio of position estimation system
com_f4_ref_id	float	d-axis current reference in open loop mode [A]
com_f4_ol_id_up_step	float	d-axis current reference ramping up rate
com_f4_ol_id_down_step	float	d-axis current reference ramping down rate
com_f4_id_down_speed_rpm	float	Speed when start to subtract d-axis current reference (mechanical angle) [rpm]
com_f4_id_up_speed_rpm	float	Speed when start to add d-axis current reference (mechanical angle) [rpm]
com_f4_max_speed_rpm	float	Maximum speed value (mechanical angle) [rpm]
com_f4_overspeed_limit_rpm	float	Speed limit (mechanical angle) [rpm]
com_f4_overcurrent_limit	float	Over current limit [A]
com_f4_iq_limit	float	q-axis current limit [A]
com_f4_limit_speed_change	float	Change speed limit (electrical angle) [rad/s]
com_u1_enable_write	uint8_t	Enabled to rewriting variables (rewritten when the same values as g_u1_enable_write are written)

### 4.4.4 Operation Example for Analyzer

Following example shows motor driving operation using Analyzer. Operation is using “Control Window” as shown in Figure 4-4. Regarding specification of “Control Window”, refer to ‘Renesas Motor Workbench User’s Manual’.

- Change the user interface to Analyzer

- (1) Confirm the check-boxes of column [W?] for ‘com\_u1\_sw\_userif’ marks.
- (2) Input ‘0’ in the [Write] box of ‘com\_u1\_sw\_userif’.
- (3) Click the ‘Write’ button.

- Driving the motor

- (1) The [W?] check boxes contain checkmarks for “com\_u1\_mode\_system”, “com\_f4\_ref\_speed\_rpm”, “com\_u1\_enable\_write”
- (2) Type a reference speed value in the [Write] box of “com\_f4\_ref\_speed\_rpm”.
- (3) Click the “Write” button.
- (4) Click the “Read” button. Confirm the [Read] box of “com\_f4\_ref\_speed\_rpm”, ”g\_u1\_enable\_write”.
- (5) Enter the value of “g\_u1\_enable\_write” in the [Write] box of “com\_u1\_enable\_write”.
- (6) Enter “1” in the [Write] box of “com\_u1\_mode\_system”.
- (7) Click the “Write” button.

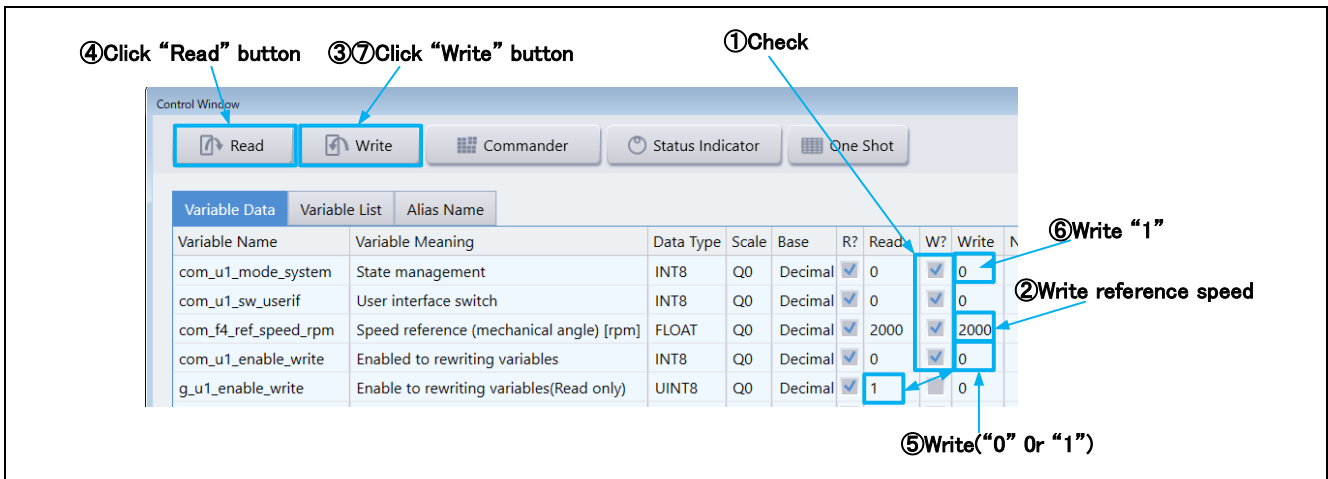

Figure 4-9 Procedure - Driving the motor

- Stop the motor

- (1) Enter “0” in the [Write] box of “com\_u1\_mode\_system”.
- (2) Click the “Write” button.

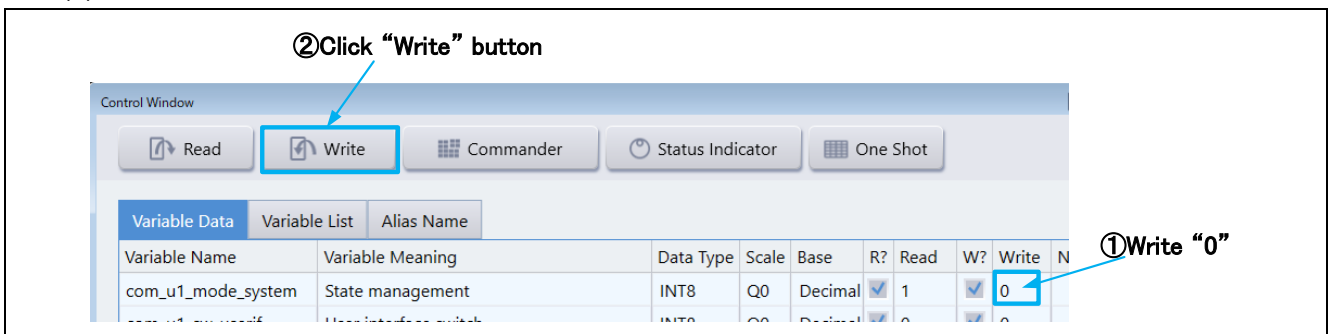

Figure 4-10 Procedure - Stop the motor

- Error cancel operation

- (1) Enter "3" in the [Write] box of "com\_u1\_mode\_system".
- (2) Click the "Write" button.

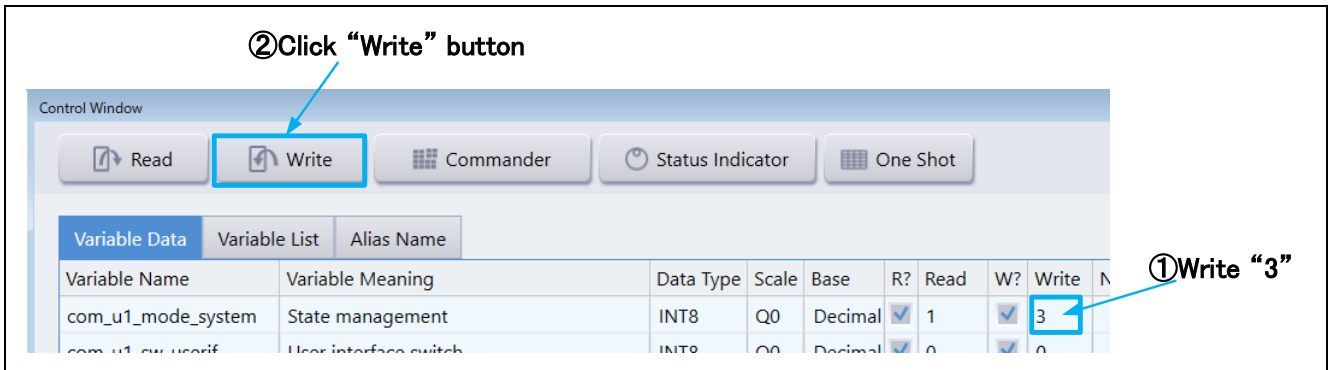

Figure 4-11 Procedure - Error cancel operation

#### 4.4.5 Tuner function

For sensorless 1shunt vector control, regrettably there is no sample code to support "Tuner" function. Therefore, if you want to confirm the motor parameters with "Tuner" function, please use the executable file provided by Renesas Motor Workbench or "RA6T2(RA8T1,RA6T3,RA4T1)\_MCILV1\_SPM\_LESS\_FOC\_TUNER\_E2S\_Vxxx" included in the sample software with 2shunts (or 3shunts). At that time, please take care to change current detection settings (refer to 2.2.2).

For details on how to use the Tuner function, refer to the Renesas Motor Workbench User's Manual.

#### 4.4.6 Example of changing communication speed

The procedure for changing the communication speed of Renesas Motor Workbench with the sample software is shown below. See the Renesas Motor Workbench User's Manual for the values to change.

- Change the communication speed setting of the sample software (when the required communication rate is 10 Mbps)
  - (1) Press the Clock button on the Main Window to change the value to 80,000,000  
This value was calculated by multiplying the default 8,000,000 by 10 because the UART communication baud rate was changed from 1Mbps to 10Mbps.
  - (2) Select the COM of the connected kit in the COM of Connection

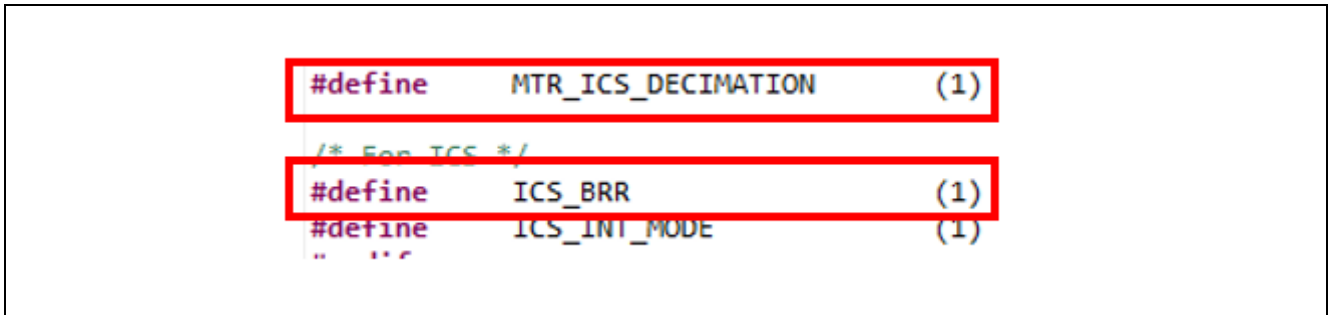

Figure 4-12 Modification of r\_mtr\_ics.h

- Change the communication speed setting of Renesas Motor Workbench to connect
  - (1) Press the Clock button on the Main Window to change the value to 80,000,000
  - (2) Change the value of MTR\_ICS\_DECIMATION in r\_mtr\_ics.h to 1.

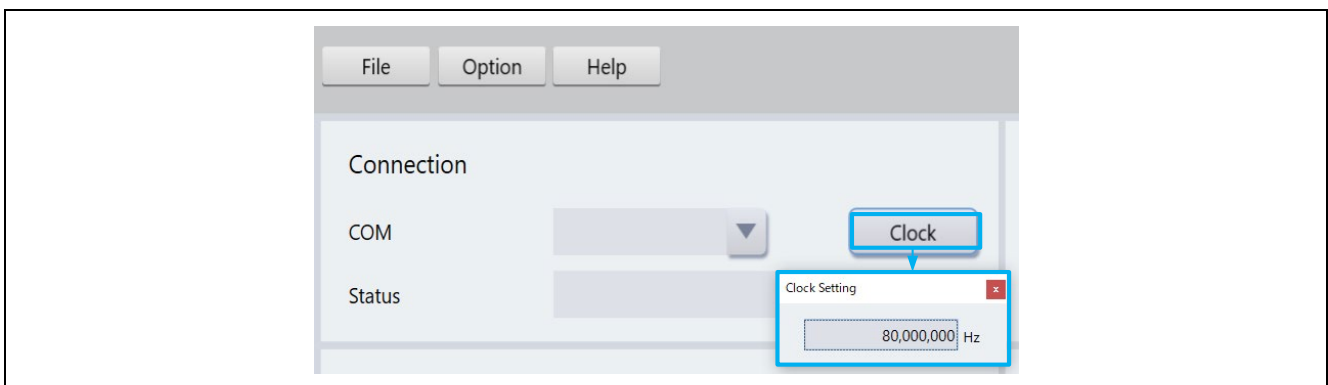

Figure 4-13 Clock frequency setting

If the connection fails, repeat the procedure for reconnecting after resetting the communication board.

#### 4.4.7 How to use the built-in communication library

The procedure for connecting to Renesas Motor Workbench using the built-in communication library without using the communication board with the sample software is shown below.

- Connection between PC and CPU board
  - (1) Connect the CPU board and PC via a USB / serial conversion board, etc.

- Preparing a project for built-in communication (example of RA6T2 921600bps)

(1) Cancel the registration of ICS2\_RA6T2.o

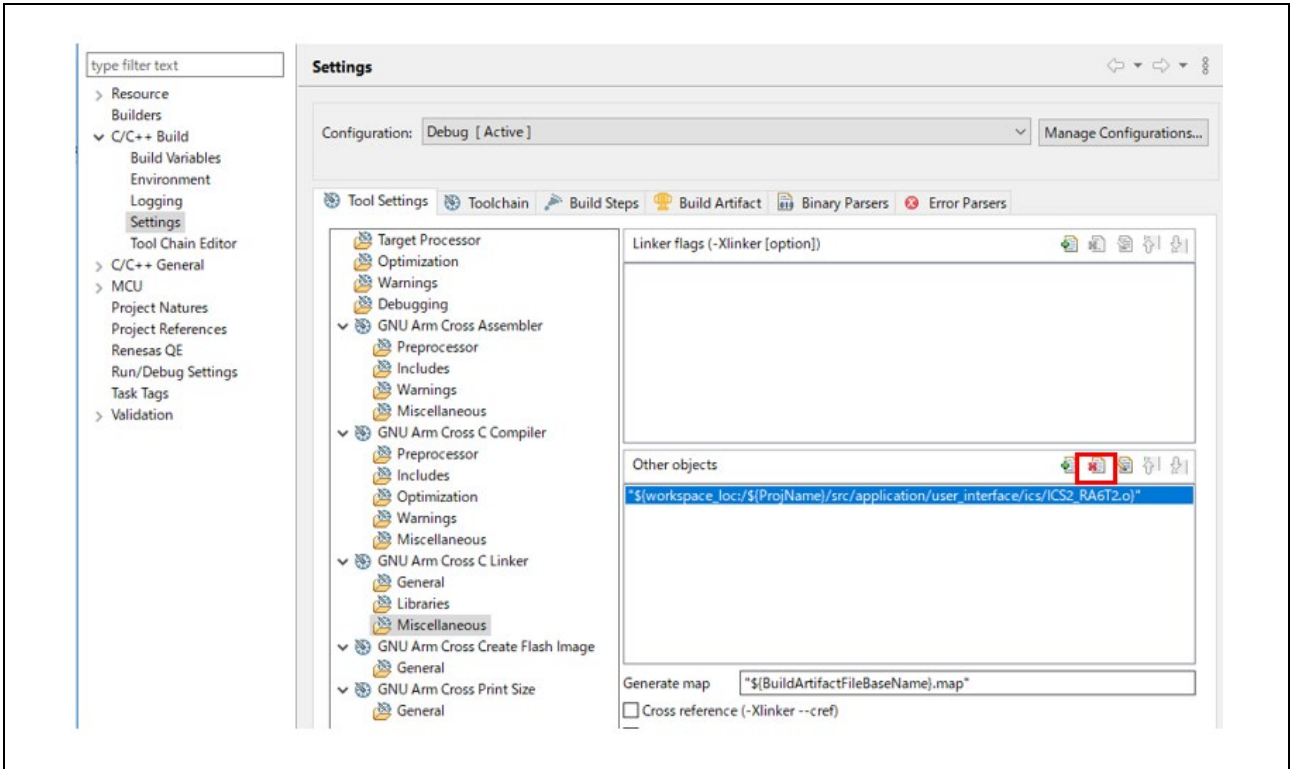

Figure 4-14 Unregister ICS2\_RA6T2.o

(2) Register ICS2\_RA6T2\_Built\_in.o

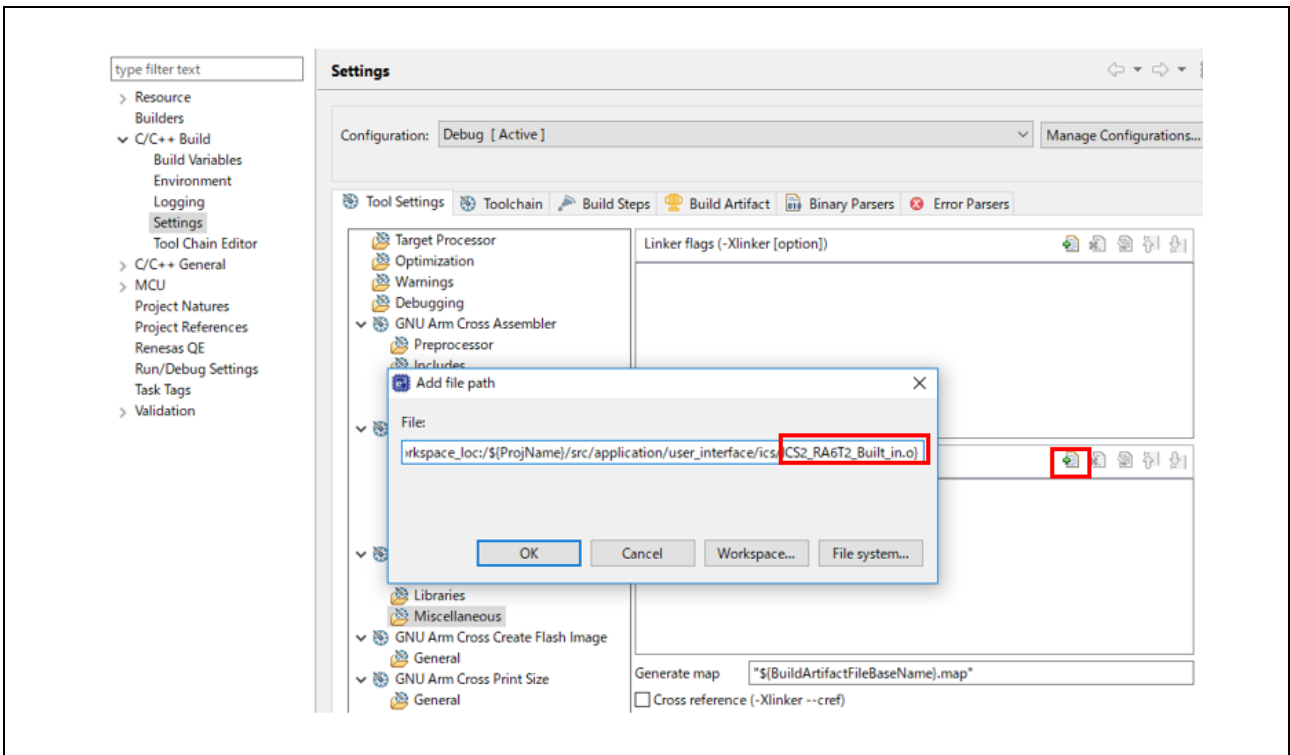

Figure 4-15 Register ICS2\_RA6T2.o



(3) Change the value of USE\_BUILT\_IN in r\_mtr\_ics.h to 1.

```
#define USE_BUILT_IN (1)

#if USE_BUILT_IN
#define MTR_ICS_DECIMATION (1)

/* For ICS */
#define ICS_BRR (21)
#define ICS_INT_MODE (1)
```

Figure 4-16 Modification of r\_mtr\_ics.h

- Change the communication baud rate setting of Renesas Motor Workbench to connect
  - (1) Change the value to 921,600 with Baud rate Dialog from the Option menu of the Main Window.
  - (2) Select the COM port of the connected kit in the COM of Connection.

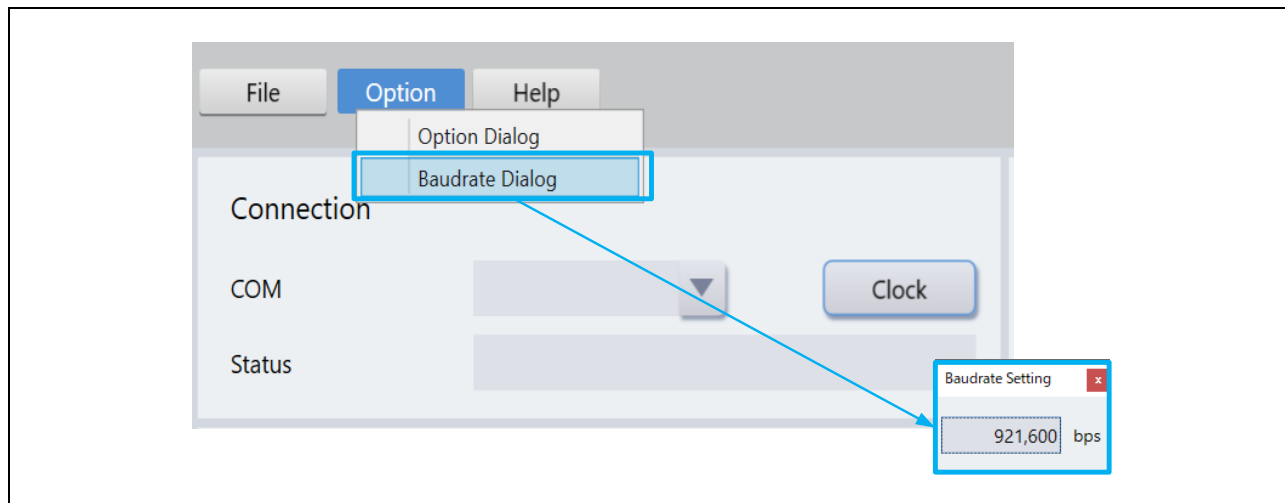

Figure 4-17 Baud rate setting

## 5. Reference Documents

RA6T2 Group User's Manual: Hardware (R01UH0951)

RA4T1 Group User's Manual: Hardware (R01UH0998)

RA6T3 Group User's Manual: Hardware (R01UH0999)

RA8T1 Group User's Manual: Hardware (R01UH1016)

RA Flexible Software Package Documentation

Application note: 'Sensorless vector control for permanent magnet synchronous motor (Algorithm)'  
(R01AN3786)

Renesas Motor Workbench User's Manual (R21UZ0004)

Renesas Motor Workbench Quick start guide (R21QS0011)

MCK-RA6T2 User's Manual (R12UZ0091)

MCK-RA4T1 User's Manual (R12UZ0114)

MCK-RA6T3 User's Manual (R12UZ0115)

MCK-RA8T1 User's Manual (R12UZ0133)

## Revision History

Rev.	Date	Description	
		Page	Summary
1.00	May 23, 2023	-	First edition issued
1.10	Jan 23, 2024	-	Added description related to RA8T1

# General Precautions in the Handling of Microprocessing Unit and Microcontroller Unit Products

The following usage notes are applicable to all Microprocessing unit and Microcontroller unit products from Renesas. For detailed usage notes on the products covered by this document, refer to the relevant sections of the document as well as any technical updates that have been issued for the products.

## 1. Precaution against Electrostatic Discharge (ESD)

A strong electrical field, when exposed to a CMOS device, can cause destruction of the gate oxide and ultimately degrade the device operation. Steps must be taken to stop the generation of static electricity as much as possible, and quickly dissipate it when it occurs. Environmental control must be adequate. When it is dry, a humidifier should be used. This is recommended to avoid using insulators that can easily build up static electricity.

Semiconductor devices must be stored and transported in an anti-static container, static shielding bag or conductive material. All test and measurement tools including work benches and floors must be grounded. The operator must also be grounded using a wrist strap. Semiconductor devices must not be touched with bare hands. Similar precautions must be taken for printed circuit boards with mounted semiconductor devices.

## 2. Processing at power-on

The state of the product is undefined at the time when power is supplied. The states of internal circuits in the LSI are indeterminate and the states of register settings and pins are undefined at the time when power is supplied. In a finished product where the reset signal is applied to the external reset pin, the states of pins are not guaranteed from the time when power is supplied until the reset process is completed. In a similar way, the states of pins in a product that is reset by an on-chip power-on reset function are not guaranteed from the time when power is supplied until the power reaches the level at which resetting is specified.

## 3. Input of signal during power-off state

Do not input signals or an I/O pull-up power supply while the device is powered off. The current injection that results from input of such a signal or I/O pull-up power supply may cause malfunction and the abnormal current that passes in the device at this time may cause degradation of internal elements. Follow the guideline for input signal during power-off state as described in your product documentation.

## 4. Handling of unused pins

Handle unused pins in accordance with the directions given under handling of unused pins in the manual. The input pins of CMOS products are generally in the high-impedance state. In operation with an unused pin in the open-circuit state, extra electromagnetic noise is induced in the vicinity of the LSI, an associated shoot-through current flows internally, and malfunctions occur due to the false recognition of the pin state as an input signal become possible.

## 5. Clock signals

After applying a reset, only release the reset line after the operating clock signal becomes stable. When switching the clock signal during program execution, wait until the target clock signal is stabilized. When the clock signal is generated with an external resonator or from an external oscillator during a reset, ensure that the reset line is only released after full stabilization of the clock signal. Additionally, when switching to a clock signal produced with an external resonator or by an external oscillator while program execution is in progress, wait until the target clock signal is stable.

## 6. Voltage application waveform at input pin

Waveform distortion due to input noise or a reflected wave may cause malfunction. If the input of the CMOS device stays in the area between  $V_{IL}$  (Max.) and  $V_{IH}$  (Min.) due to noise, for example, the device may malfunction. Take care to prevent chattering noise from entering the device when the input level is fixed, and also in the transition period when the input level passes through the area between  $V_{IL}$  (Max.) and  $V_{IH}$  (Min.).

## 7. Prohibition of access to reserved addresses

Access to reserved addresses is prohibited. The reserved addresses are provided for possible future expansion of functions. Do not access these addresses as the correct operation of the LSI is not guaranteed.

## 8. Differences between products

Before changing from one product to another, for example to a product with a different part number, confirm that the change will not lead to problems. The characteristics of a microprocessing unit or microcontroller unit products in the same group but having a different part number might differ in terms of internal memory capacity, layout pattern, and other factors, which can affect the ranges of electrical characteristics, such as characteristic values, operating margins, immunity to noise, and amount of radiated noise. When changing to a product with a different part number, implement a system-evaluation test for the given product.

## Notice

1. Descriptions of circuits, software and other related information in this document are provided only to illustrate the operation of semiconductor products and application examples. You are fully responsible for the incorporation or any other use of the circuits, software, and information in the design of your product or system. Renesas Electronics disclaims any and all liability for any losses and damages incurred by you or third parties arising from the use of these circuits, software, or information.
2. Renesas Electronics hereby expressly disclaims any warranties against and liability for infringement or any other claims involving patents, copyrights, or other intellectual property rights of third parties, by or arising from the use of Renesas Electronics products or technical information described in this document, including but not limited to, the product data, drawings, charts, programs, algorithms, and application examples.
3. No license, express, implied or otherwise, is granted hereby under any patents, copyrights or other intellectual property rights of Renesas Electronics or others.
4. You shall be responsible for determining what licenses are required from any third parties, and obtaining such licenses for the lawful import, export, manufacture, sales, utilization, distribution or other disposal of any products incorporating Renesas Electronics products, if required.
5. You shall not alter, modify, copy, or reverse engineer any Renesas Electronics product, whether in whole or in part. Renesas Electronics disclaims any and all liability for any losses or damages incurred by you or third parties arising from such alteration, modification, copying or reverse engineering.
6. Renesas Electronics products are classified according to the following two quality grades: "Standard" and "High Quality". The intended applications for each Renesas Electronics product depends on the product's quality grade, as indicated below.
  - "Standard": Computers; office equipment; communications equipment; test and measurement equipment; audio and visual equipment; home electronic appliances; machine tools; personal electronic equipment; industrial robots; etc.
  - "High Quality": Transportation equipment (automobiles, trains, ships, etc.); traffic control (traffic lights); large-scale communication equipment; key financial terminal systems; safety control equipment; etc.Unless expressly designated as a high reliability product or a product for harsh environments in a Renesas Electronics data sheet or other Renesas Electronics document, Renesas Electronics products are not intended or authorized for use in products or systems that may pose a direct threat to human life or bodily injury (artificial life support devices or systems; surgical implantations; etc.), or may cause serious property damage (space system; undersea repeaters; nuclear power control systems; aircraft control systems; key plant systems; military equipment; etc.). Renesas Electronics disclaims any and all liability for any damages or losses incurred by you or any third parties arising from the use of any Renesas Electronics product that is inconsistent with any Renesas Electronics data sheet, user's manual or other Renesas Electronics document.
7. No semiconductor product is absolutely secure. Notwithstanding any security measures or features that may be implemented in Renesas Electronics hardware or software products, Renesas Electronics shall have absolutely no liability arising out of any vulnerability or security breach, including but not limited to any unauthorized access to or use of a Renesas Electronics product or a system that uses a Renesas Electronics product. RENESAS ELECTRONICS DOES NOT WARRANT OR GUARANTEE THAT RENESAS ELECTRONICS PRODUCTS, OR ANY SYSTEMS CREATED USING RENESAS ELECTRONICS PRODUCTS WILL BE INVULNERABLE OR FREE FROM CORRUPTION, ATTACK, VIRUSES, INTERFERENCE, HACKING, DATA LOSS OR THEFT, OR OTHER SECURITY INTRUSION ("Vulnerability Issues"). RENESAS ELECTRONICS DISCLAIMS ANY AND ALL RESPONSIBILITY OR LIABILITY ARISING FROM OR RELATED TO ANY VULNERABILITY ISSUES. FURTHERMORE, TO THE EXTENT PERMITTED BY APPLICABLE LAW, RENESAS ELECTRONICS DISCLAIMS ANY AND ALL WARRANTIES, EXPRESS OR IMPLIED, WITH RESPECT TO THIS DOCUMENT AND ANY RELATED OR ACCOMPANYING SOFTWARE OR HARDWARE, INCLUDING BUT NOT LIMITED TO THE IMPLIED WARRANTIES OF MERCHANTABILITY, OR FITNESS FOR A PARTICULAR PURPOSE.
8. When using Renesas Electronics products, refer to the latest product information (data sheets, user's manuals, application notes, "General Notes for Handling and Using Semiconductor Devices" in the reliability handbook, etc.), and ensure that usage conditions are within the ranges specified by Renesas Electronics with respect to maximum ratings, operating power supply voltage range, heat dissipation characteristics, installation, etc. Renesas Electronics disclaims any and all liability for any malfunctions, failure or accident arising out of the use of Renesas Electronics products outside of such specified ranges.
9. Although Renesas Electronics endeavors to improve the quality and reliability of Renesas Electronics products, semiconductor products have specific characteristics, such as the occurrence of failure at a certain rate and malfunctions under certain use conditions. Unless designated as a high reliability product or a product for harsh environments in a Renesas Electronics data sheet or other Renesas Electronics document, Renesas Electronics products are not subject to radiation resistance design. You are responsible for implementing safety measures to guard against the possibility of bodily injury, injury or damage caused by fire, and/or danger to the public in the event of a failure or malfunction of Renesas Electronics products, such as safety design for hardware and software, including but not limited to redundancy, fire control and malfunction prevention, appropriate treatment for aging degradation or any other appropriate measures. Because the evaluation of microcomputer software alone is very difficult and impractical, you are responsible for evaluating the safety of the final products or systems manufactured by you.
10. Please contact a Renesas Electronics sales office for details as to environmental matters such as the environmental compatibility of each Renesas Electronics product. You are responsible for carefully and sufficiently investigating applicable laws and regulations that regulate the inclusion or use of controlled substances, including without limitation, the EU RoHS Directive, and using Renesas Electronics products in compliance with all these applicable laws and regulations. Renesas Electronics disclaims any and all liability for damages or losses occurring as a result of your noncompliance with applicable laws and regulations.
11. Renesas Electronics products and technologies shall not be used for or incorporated into any products or systems whose manufacture, use, or sale is prohibited under any applicable domestic or foreign laws or regulations. You shall comply with any applicable export control laws and regulations promulgated and administered by the governments of any countries asserting jurisdiction over the parties or transactions.
12. It is the responsibility of the buyer or distributor of Renesas Electronics products, or any other party who distributes, disposes of, or otherwise sells or transfers the product to a third party, to notify such third party in advance of the contents and conditions set forth in this document.
13. This document shall not be reprinted, reproduced or duplicated in any form, in whole or in part, without prior written consent of Renesas Electronics.
14. Please contact a Renesas Electronics sales office if you have any questions regarding the information contained in this document or Renesas Electronics products.

(Note1) "Renesas Electronics" as used in this document means Renesas Electronics Corporation and also includes its directly or indirectly controlled subsidiaries.

(Note2) "Renesas Electronics product(s)" means any product developed or manufactured by or for Renesas Electronics.

(Rev.5.0-1 October 2020)

## Corporate Headquarters

TOYOSU FORESIA, 3-2-24 Toyosu,  
Koto-ku, Tokyo 135-0061, Japan

[www.renesas.com](http://www.renesas.com)

## Trademarks

Renesas and the Renesas logo are trademarks of Renesas Electronics Corporation. All trademarks and registered trademarks are the property of their respective owners.

## Contact information

For further information on a product, technology, the most up-to-date version of a document, or your nearest sales office, please visit:

[www.renesas.com/contact/](http://www.renesas.com/contact/).