

## RX671 Group

### Voice Recognition, Touch and Cloud Solution Using Renesas Starter Kit+ for RX671

---

#### Introduction

The Renesas Starter Kit+ for RX671 is the best kit for developing IoT applications equipped with Voice recognition, Capacitive Touch Interface.

This application note shows an HMI solution that realizes voice recognition, touch function, and LCD by PMOD-LCD module using the Renesas Starter Kit+ for RX671. And also introduces an Amazon Web Services (hereinafter referred to as AWS) cloud solution using the PMOD-Wi-Fi module (sold separately).

An executable file (trial version) that can be downloaded and experienced on the Renesas Starter Kit+ for RX671 is attached to this application note. There are two trial versions, AmiVoice® version and Voice Trigger version. **The trial versions of AmiVoice® and Voice Trigger can run for only 5 minutes after a reset. Please reset every 5 minutes.**

If you would like to obtain the sample source code, please contact Renesas dealer or Renesas sales representative.

The demo software described in this application note is configured using the following libraries.

- Voice recognition 1: Voice recognition middleware AmiVoice®, hereinafter referred to as “AmiVoice®”.
- Voice recognition 2: Voice recognition middleware Voice Trigger, hereinafter referred to as “Voice Trigger”.
- Noise reduction: “Zoom Voice Software”, hereinafter referred to as “Zoom Voice”.
- OS: Amazon FreeRTOS (202012.00), hereinafter referred to as “FreeRTOS”.

#### Target Device

RX671 Group

#### Operation Check Tool

Renesas Starter Kit+ for RX671

## Contents

1. Overview of the System.....	4
1.1 System Overview Diagram.....	4
1.2 Demo Overview.....	4
1.2.1 Voice and Touch Interface (Standalone version).....	4
1.2.2 Voice and Touch Interface (Cloud version).....	4
2. Hardware Preparation.....	5
2.1 Constitution of the Hardware.....	5
2.1.1 Constitution of the Standalone Version.....	5
2.1.2 Constitution of the Cloud Version.....	5
2.2 About Renesas Starter Kit Board Modification (cloud version only).....	6
2.2.1 PMOD2 Connection Destination.....	6
2.2.2 Board Modification Points.....	7
2.2.3 Mounting Locations.....	8
2.3 Board Connection.....	9
3. Software Preparation.....	10
3.1 Selection from 2 Types of Programs.....	10
3.2 Programming the Selected Programs to RX671.....	10
3.3 Preparation of AWS (Cloud version only).....	12
3.4 Setting for Certification (Cloud version only).....	12
4. Starting the Demo for Standalone Version.....	16
4.1 Renesas Starter Kit+ for RX671 Power On to Voice Command Standby Screen.....	16
4.2 Selecting the Language Mode of Renesas Starter Kit+ for RX671.....	17
4.2.1 Acceptable Voice Commands.....	17
4.3 Possible Functions on the Standby Screen After the Board is Turned On.....	18
4.4 Possible Functions on Air Conditioner Mode.....	18
4.4.1 Change the Set Temperature.....	18
4.4.2 Switching Between Heating and Cooling.....	19
4.4.3 Power Off of Air Conditioner.....	19
4.5 Parameter Setting Function of Voice Recognition Engine.....	20
4.5.1 Types of Parameters that can be Set.....	20
4.5.2 How to Start Parameter Setting Screen.....	21
5. Starting the Demo for Cloud Version.....	22
5.1 Operation for Touch Interface and Voice Interface.....	22
5.2 shadow.....	22
5.3 Device Properties.....	23

5.4	Operating Procedure of the shadow.....	23
5.5	Data Confirmation by AWS .....	25
6.	Confirmed Conditions of the Operation.....	26
6.1	Confirmed Conditions of the Operation.....	26
7.	Software .....	28
7.1	Software Hierarchy.....	28
7.2	Flowchart.....	28
8.	Reference Documents.....	29
9.	Notice for Board Modification.....	30
	Revision History.....	31

- AmiVoice® is a product of Advanced Media, Inc. and is a registered trademark in Japan or other countries.
- Voice Trigger is a product of Toshiba Digital Solutions Corporation.
- Zoom Voice is a product of Techno Mathematical Co., Ltd..
- Development using AmiVoice® and Zoom Voice requires contract separately with each developer.
- AWS™ is a trademark of Amazon.com, Inc. or its affiliates. (<https://aws.amazon.com/trademark-guidelines/>)
- FreeRTOS™ is a trademark of Amazon Web Services, Inc. (<https://freertos.org/copyright.html>)
- GitHub® is a registered trademark of GitHub, Inc. (<https://github.com/logos>)
- Pmod is a trademark of Digilent Inc. (<https://store.digilentinc.com/>)

## 1. Overview of the System

### 1.1 System Overview Diagram

Figure 1-1 shows System Overview Diagram.

In this demo, the microphones installed in the Renesas Starter Kit+ for RX671 are used for voice recognition. The LCD display is realized by connecting the PMOD-LCD module included with the Renesas Starter Kit+ for RX671 to PMOD1. Connection to the AWS is realized by connecting the separately sold Wi-Fi Pmod Expansion Board (RTK00WFMX0B00000BE) (hereinafter referred to as Wi-Fi module) to PMOD2.

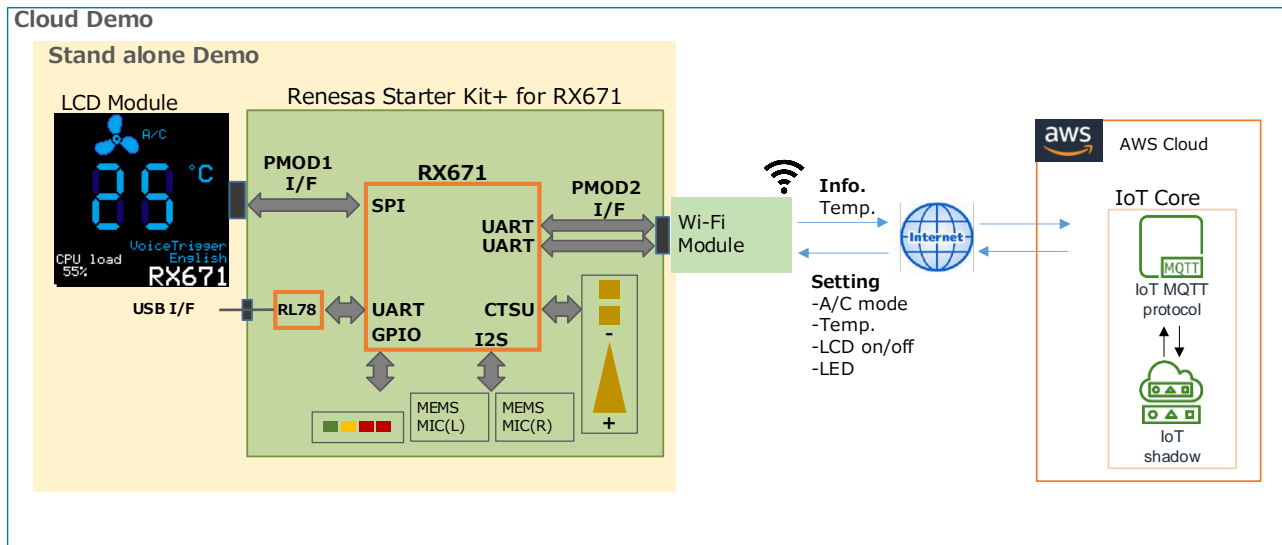

Figure 1-1 System Overview Diagram

## 1.2 Demo Overview

This demo software provides two types of demos that assume a remote-control function for air conditioner control.

### 1.2.1 Voice and Touch Interface (Standalone Version)

This demo works with the Renesas Starter Kit+ for RX671 and an LCD module. You can operate the remote control by voice or touch. You can also check the CPU resource usage. No Wi-Fi module is required as it does not connect to the cloud. Hereafter, this demo will be referred to as the standalone version.

### 1.2.2 Voice and Touch Interface (Cloud Version)

It connects to the cloud (AWS) via a Wi-Fi module and enables remote control. In addition to the operation of the standalone version, you can check the set temperature and change the set temperature in operation with AWS. This demo uses a Wi-Fi module (sold separately). Hereafter, this demo will be referred to as the cloud version.

## 2. Hardware Preparation

### 2.1 Constitution of the Hardware

Table 2.1 shows hardware used in this demo.

**Table 2.1 Hardware List**

Item	Provider	Description
(1) Renesas Starter Kit+ for RX671	Renesas Electronics Corporation	Evaluation board equipped with RX671
(2) Pmod LCD module	Renesas Electronics Corporation	PMOD-LCD module included in the Renesas Starter Kit+ for RX671
(3) E2 emulator Lite	Renesas Electronics Corporation	On-chip debugging emulator and flash programmer
(4) PC	Windows 10	Recommended OS
	Google Chrome	Browser to use
(5) Wi-Fi Pmod Expand Board	Renesas Electronics Corporation	Wi-Fi module
(6) Wi-Fi router	—	Wireless LAN standard: IEEE 802.11b / g / n (2.4GHz) Encryption method: ES

#### 2.1.1 Constitution of the Standalone Version

In the standalone version, use items (1) to (4) in Table 2.1 Hardware List.

#### 2.1.2 Constitution of the Cloud Version

In the cloud version, all of Table 2.1 Hardware List (1) to (6) are used.

In the cloud version, it is necessary to modify the Renesas Starter Kit+ for RX671.

Please refer to "2.2 About Renesas Starter Kit Board Modification (cloud version only)" for the modification method.

## 2.2 About Renesas Starter Kit Board Modification (cloud version only)

In the cloud version, it is necessary to modify the Renesas Starter Kit+ for RX671 board to connect the Wi-Fi module to PMOD2. The Wi-Fi module cannot be connected to PMOD2 in the initial state at the time of product shipment. This modification is not required for the standalone version.

### 2.2.1 PMOD2 Connection Destination

In contrast to the table in "Table 5.7 Pmod™ Connector PMOD2" in the Renesas Starter Kit+ for RX671 User's Manual, the terminals used to connect the Wi-Fi module this time are shown in red in Table 2.2.

Table 2.2 List of PMOD2 Connection Destinations

Pin	Pmod™ Interface			MCU	
	Type 2A (SPI)	Type 3A (UART)	Type 6A (I2C)	Port	Pin No.
1	CS	CTS/GPIO	INT	PJ5/CTS2#/IRQ13	11
2	MOSI	TXD	RESET	P13/TXD2/SMOSI2*2	44
				P51*2	55
3	MISO	RXD	SCL	P12/RXD2/SMISO2/SSCL2*2	45
4	SCK	RTS/GPIO	SDA	P51/SCK2*2	55
				P13/SSDA2*2	44
5	GND	GND	GND	-	-
6	3V3*1	3V3*1	3V3/5V*1	-	-
7	GPIO/INT	GPIO/INT	GPIO	P82/IRQ2	63
8	GPIO/RESET	GPIO/RESET	GPIO	P90	131
9	GPIO/CS2	GPIO	GPIO	P32/TXD0*2 *3	27
10	GPIO/CS3	GPIO	GPIO	P33/RXD0*2 *3	26
11	GND	GND	GND	-	-
12	3V3*1	3V3*1	3V3/5V*1	-	-

Note: The table above is from Renesas Starter Kit+ for RX671 User's Manual Table 5.7: Pmod™ Connector PMOD2

2.2.2 Board Modification Points

Select the connection in the red frame in Table 2.3. Mount the following jumper header pins and remove the resistors.

- P13: J18, J17 jumper header pin mounting (J18 Pin2-3, J17 Pin1-2 short), R114 removal
- P12: J21 jumper header pin mounting (J21 Pin2-3 short), R152 removal
- P33: J22 jumper header pin mounting (J22 Pin2-3 short), R189 removal
- P32: J23 jumper header pin mounting (J23 Pin2-3 short), R208 removal
- P52: J19 jumper header pin mounting (J19 Pin1-2 short), R225 removal

Table 2.3 PMOD2 Option Link

Signal name	MCU		MCU Peripheral function selection			Select connection destination		
	Pin	Port	Signal	Implementation	Non Implementation	Interface / Function	Implementation	Non Implementation
P13	44	P13	E2P-SDA	R114 or J18.Pin1-2, R115	-	U9.5	-	-
			JA1-SDA	R114 or J18.Pin1-2, R116	-	JA1.25	-	-
			PMOD2-IO1_MOSI_TXD	J18.Pin2-3, J17.Pin1-2	R114	PMOD2.2	R326, J19.Pin1-2	R225, R222
			PMOD2-SDA	J18.Pin2-3, J17.Pin2-3	R114	PMOD2.4	J20.Short, J19.Pin2-3	R225, R222
P12	45	P12	E2P-SCL	R152 or J21.Pin1-2, R153	-	U9.6	-	-
			JA1-SCL	R152 or J21.Pin1-2, R154	-	JA1.26	-	-
			PMOD2-IO2_MISO_RXD_SCL	J21.Pin2-3	R152	PMOD2.3	-	-
P33	26	P33	CAN-RX	R189 or J22.Pin1-2, R188	R190	U12.4	-	-
			JA5-CAN1RX	R189 or J22.Pin1-2, R190	R188	JA5.6	-	-
			PMOD2-IO7_CS2_WIFIRXD	J22.Pin2-3	R189	PMOD2.10	-	-
P32	27	P32	CAN-TX	R208 or J23.Pin1-2, R207	R209	U12.3	-	-
			JA5-CAN1TX	R208 or J23.Pin1-2, R209	R207	JA5.5	-	-
			PMOD2-IO6_CS1_WIFITXD	J23.Pin2-3	R208	PMOD2.9	-	-
P51	55	P51	PMOD2-IO3_SCK_RTS	J19.Pin1-2	R225, R222	PMOD2.4	-	J20.Open
			PMOD2-RESET0	J19.Pin2-3	R225, R222	PMOD2.2	R326	-
			JA3-WRHn	R225	J19, R222	JA3.47	R247	R248
			JA3-WAIT	R222	R225, J19	JA3.45	R244	R243
PMOD2-IO4_INT1_WIFIWKUP	63	P82	PMOD2-IO4_INT1_WIFIWKUP	-	-	PMOD2.7	-	-
PMOD2-IO5_RESET1_WIFIMDR ES	131	P90	PMOD2-IO5_RESET1_WIFIMDR ES	-	-	PMOD2.8	-	-
PMOD2-IO0_CS0_INT0	11	PJ5	PMOD2-IO0_CS0_INT0	-	-	PMOD2.1	-	-

Note: The table above is from Renesas Starter Kit + for RX671 User's Manual Table 6 21: PMOD2 Option Link (1). Blue letters indicate the initial state at the time of shipment.

### 2.2.3 Mounting Locations

The mounting locations of each component are shown below.

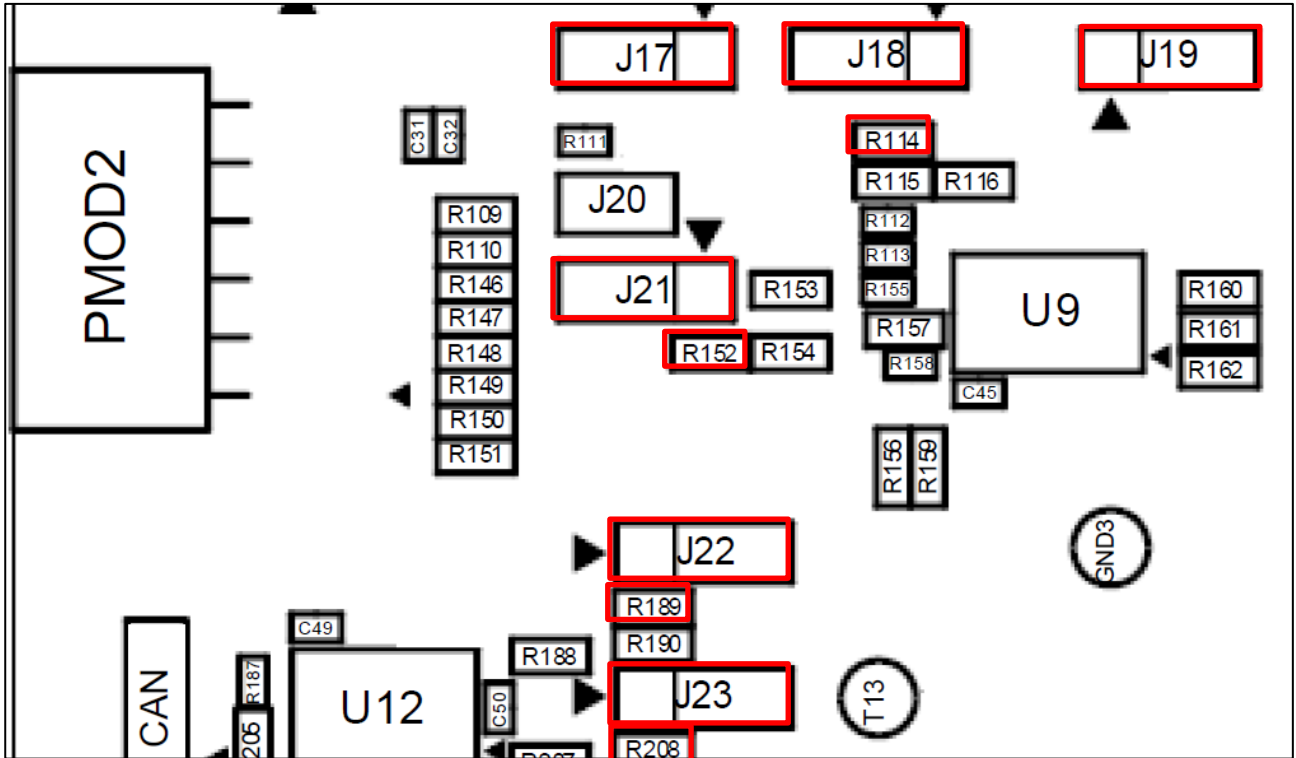

Figure 2-1 List of Mounting Locations (1/2)

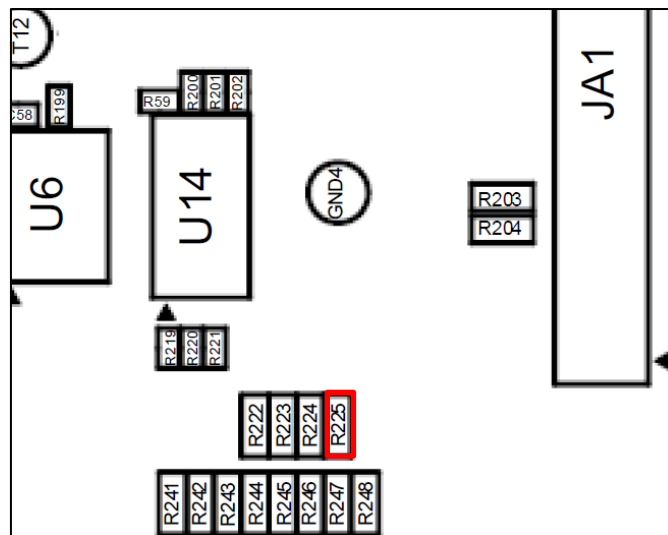

Figure 2-2 List of Mounting Locations (2/2)

Note: The figure above is from Renesas Starter Kit+ for RX671 User's Manual 3.3 Parts Layout



### 2.3 Board Connection

Shows the connection form of the board. Figure 2-3 is a photo of the board connection when using the cloud version. Blue indicates connections and components used for both the standalone and cloud versions, and yellow indicates connections and components used only for the cloud version.

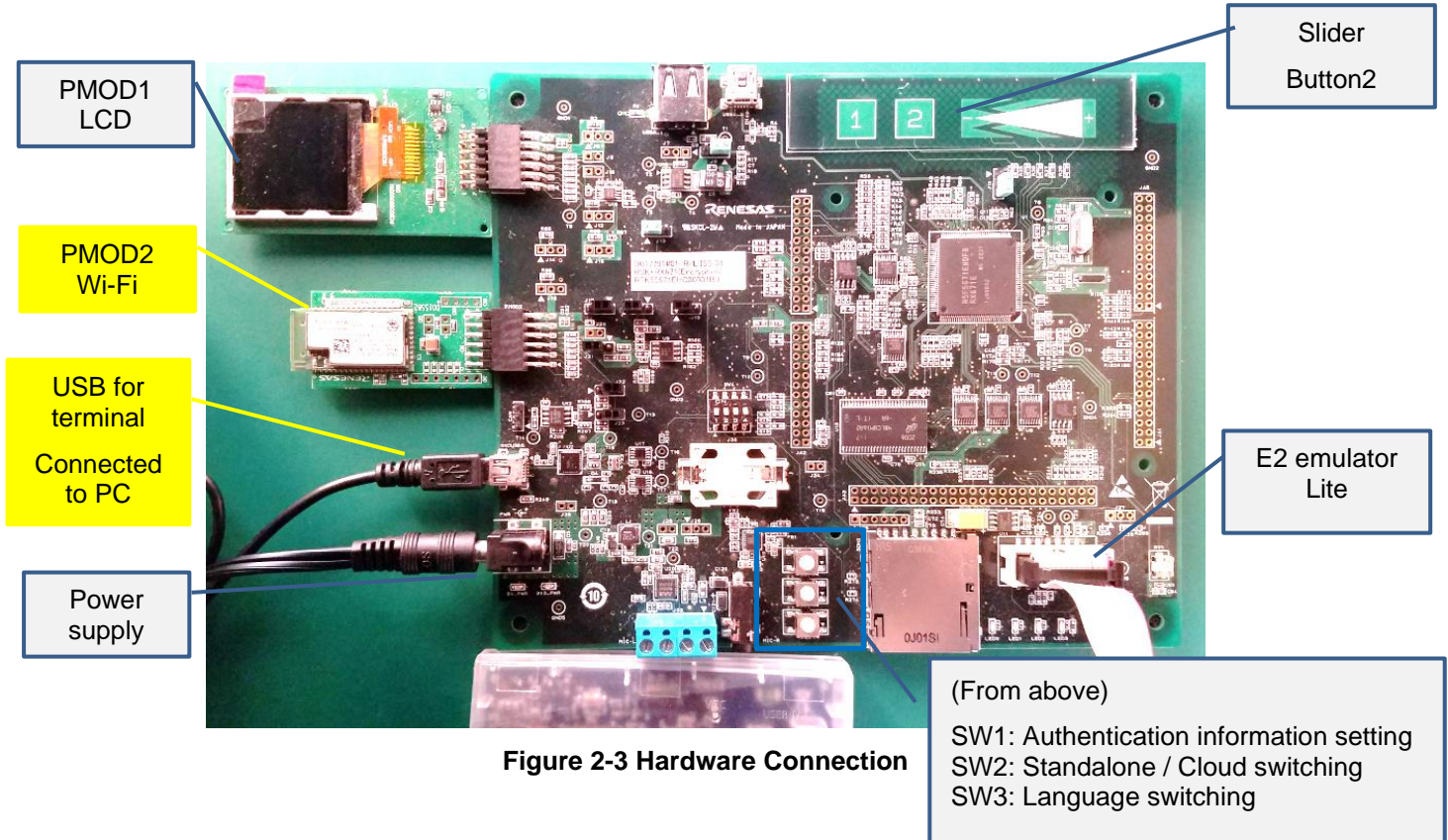

Figure 2-3 Hardware Connection

### 3. Software Preparation

#### 3.1 Selection from 2 Types of Programs

This application note includes two programs (mot files) that use different voice recognition middleware. Specifications other than voice recognition middleware are the same. Please select one of the mot files.

r01an6010_rx671_AV.mot	AmiVoice® and Zoom Voice
r01an6010_rx671_VT.mot	Voice Trigger

#### 3.2 Programming the Selected Programs to RX671

Write the mot file via E2 emulator Lite using the Renesas Flash Programmer (hereinafter referred to as RFP). The RFP version is V3.08.03.

In the RFP, select File  New Project

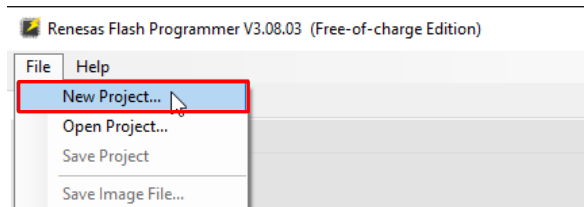

**Figure 3-1 Create a New Project**

Select RX67x for the microcontroller. Enter other required information and click Connect.

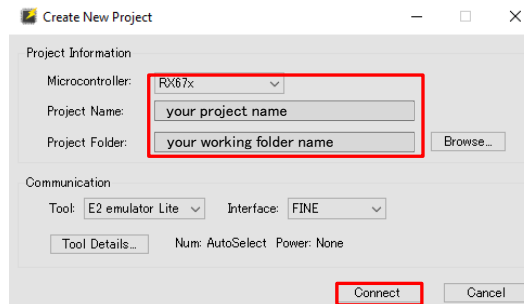

**Figure 3-2 Connect**

When the Authentication Code screen appears, just click OK.

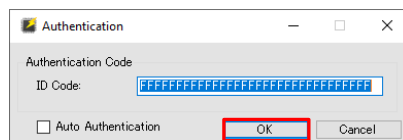

**Figure 3-3 Authentication Code Registration**

Specify the downloaded mot file as the program file and click Start.

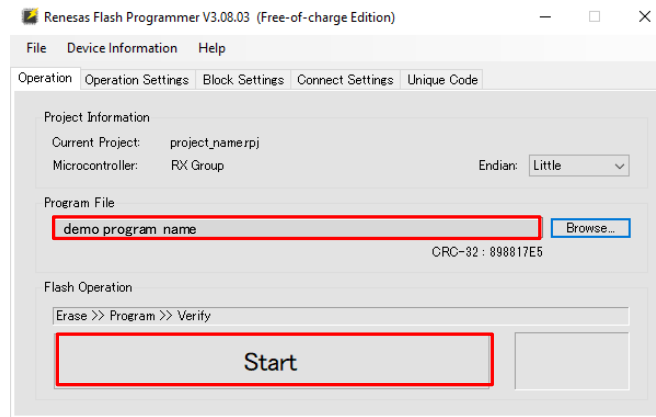

Figure 3-4 Starting the Programming

When the Authentication Code confirmation screen appears, just click OK.

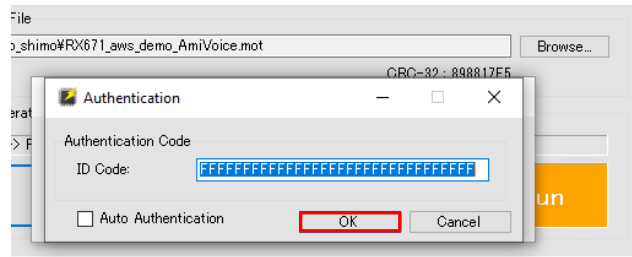

Figure 3-5 Certification Code Registration

If OK is displayed, programming is complete.

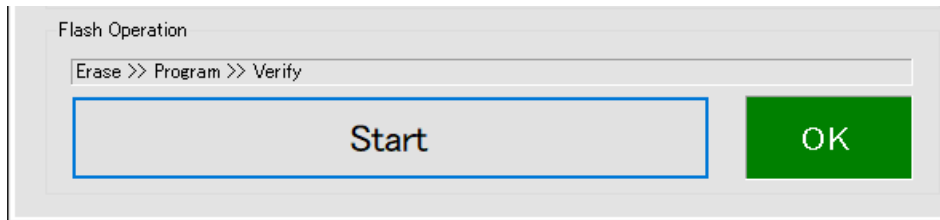

Figure 3-6 Completion Confirmation

The standalone version is ready to work. The cloud version also requires the following settings.

### 3.3 Preparation of AWS (Cloud version only)

When using the cloud version, please refer to the tutorial below to set up AWS.

- Register the device with AWS IoT

Japanese version: [Register your device with AWS IoT - renesas/amazon-freertos Wiki - GitHub](#)

English version: <https://github.com/renesas/amazon-freertos/wiki/Register-device-to-AWS-IoT>

Note: Go to "Check AWS IoT Endpoints".

### 3.4 Setting for Certification (Cloud version only)

In the cloud version, the SSID / password of the Wi-Fi access point to connect to and the client certificate / private key of the iotthing downloaded in "3.3 Preparation of AWS (Cloud version only)", the endpoint, and the information of the aws iotthingname are set using Tera Term. Table 3.1 shows the Tera Term settings.

**Table 3.1 Tera Term Settings**

Item	Setting
Baud rate	115200
Data length	8
Parity	none
Stop bits	1
Flow control	none
line feed code : Receive	LF
line feed code : Transmit	CR+LF

Follow the steps below to proceed with the settings.

1. Put Renesas Starter Kit+ for RX671 in certification information setting mode.

By resetting (power on) the Renesas Starter Kit+ for RX671 while pressing SW1, you will be in the mode to set new certification information. When the certification information setting mode is entered, the following character string is displayed in Tera Term and the status is waiting for command input.

Note: SW1 should be held down for about 1 second after resetting (power on).

```
RX671 Renesas Starter Kit
$
```

**Figure 3-7 Certification Information Setting Mode**

2. Enter the SSID of the access point to connect.

Enter "codeflash write wifissid <Wi-Fi SSID>" and press the enter key to set the SSID information. If set successfully, you will see "stored data into codeflash correctly."

```
RX671 Renesas Starter Kit
$ codeflash write wifissid xxxxxx
stored data into codeflash correctly.
```

**Figure 3-8 Set the Wi-Fi SSID Information**

3. Enter the password of the access point to connect to.

Enter “codeflash write wifipass <Wi-Fi PASSWORD>” and press the enter key to set the Wi-Fi password information. If set successfully, you will see “stored data into codeflash correctly.”.

```
$ codeflash write wifipass xxxxxx
stored data into codeflash correctly.
```

**Figure 3-9 Entry the Wi-Fi Password**

4. Enter the client private key information.

Enter “codeflash write aws clientprivatekey” and press the enter key, to waiting status for the private key to be entered.

Open the client private key (xxxxxxx-private.pem.key) generated by AWS IoT Core in "4.1 AWS Preparation" with a text editor and copy and paste it into Tera Term.

If set successfully, you will see “stored data into codeflash correctly.”.

```
$ codeflash write aws clientprivatekey
-----BEGIN RSA PRIVATE KEY-----
MIIEogIBAAKCAQEazhY82Y0DydQYFH/yFZONXFYMNJ86US+Ph+snfsinjFFU3kOp
:
: (omitted)
:
5M9Nxhh8FDzNjibzbLSZQHJNgEu9nufR0kLLxv/84heYH/W/Ako=
-----END RSA PRIVATE KEY-----
stored data into codeflash correctly.
```

**Figure 3-10 Entry the Private Key**

5. Enter the client certificate information.

Enter “codeflash write aws clientcertificate” and press the enter key to wait for the certificate to be entered.

Open the client certificate (xxxxxxx-certificate.pem.crt) generated by AWS IoT Core in "4.1 AWS Preparation" with a text editor and copy and paste it into Tera Term.

If set successfully, you will see “stored data into codeflash correctly.”.

```
$ codeflash write aws clientcertificate
-----BEGIN CERTIFICATE-----
MIIDWTCCAkGgAwIBAgIUWNAUkpzF4G0909IxarCG1nLaX08wDQYJKoZIhvcNAQEL
:
: (omitted)
:
UB2bnt0RxcqXtoihQ2KgWWWW699CWkt4EyPoCgxuQ04P4pzlmF60BbESpUfm
-----END CERTIFICATE-----
stored data into codeflash correctly.
```

**Figure 3-11 Entry of the Client Certification**

6. Enter the IoT endpoint information.

Enter “codeflash write aws mqttbrokerendpoint <mqtt\_broker\_endpoint>” and press the enter key to set the IoT endpoint information. <mqtt\_broker\_endpoint> describes the endpoint confirmed in "4.1 AWS Preparation".

If set successfully, you will see “stored data into codeflash correctly.”.

```
$ codeflash write aws mqttbrokerendpoint xxxxxx-ats.iot.ap-northeast-1.amazonaws.com
stored data into codeflash correctly.
```

**Figure 3-12 Entry the IoT Endpoint Information**

7. Enter the thing name.

Enter “codeflash write aws iotthingname <iot\_thing\_name>” and press enter to set the thing name information. <iot\_thing\_name> describes the name of the thing created in "4.1 AWS Preparation". If set successfully, you will see “stored data into codeflash correctly.”.

```
$ codeflash write aws iotthingname thing_rx671_rsk
stored data into codeflash correctly.
```

**Figure 3-13 Entry the Thing Name**

8. Check if each parameter is set correctly.

Enter “codeflash read” and press enter to see the configured parameters.

```
$ codeflash read
label = client_private_key
data = -----BEGIN RSA PRIVATE KEY-----
MIIIEogIBAAKCAQEAzhY82YODydQYFH/yFZONXFYMNJ86US+Ph+snfsinjFFU3kOp
(The following is omitted)
```

**Figure 3-14 Display of Set Parameters**

9. Finish entering the information and move to the demo program.

Enter “start demo” and press enter to move to the demo program.

```
$ start demo
RX671 Renesas Starter Kit
$ 0 41000 [Tmr Svc] Demo Start.
1 41084 [Tmr Svc] [DEBUG] [PKCS11] [core_pkcs11_mbedt . . .
4 41084 [Tmr Svc] [INFO] [PKCS11] [core_pkcs11_mbedt1 . . .
7 41084 [Tmr Svc] [DEBUG] [PKCS11] [core_pkcs11_mbedt . . .
10 41085 [Tmr Svc] [WARN] [PKCS11] [core_pkcs11_mbedt . . .
13 41085 [Tmr Svc] [WARN] [PKCS11] [core_pkcs11_mbedt . . .
( . . . )
95 41669 [iot_thread] [INFO ][DEMO][41669] -----STARTING DEMO-----

96 41671 [iot_thread] [INFO ][INIT][41671] SDK successfully initialized.
97 55098 [iot_thread] [INFO ][DEMO][55098] Successfully initialized the demo. . . .
98 55098 [iot_thread] [INFO ][MQTT][55098] MQTT library successfully initialized.
99 55098 [iot_thread] [INFO ][Shadow][55098] Shadow library successfully
initialized.(The following is omitted)
```

**Figure 3-15 Move to the Demo Program**

This demo program operates with the code flash memory operating mode as dual mode. As shown in the figure, the certification information setting data are stored in the bank area that is not the execution side of the code flash.

-Code flash memory mapping in dual mode

- (1) Block 37 (0xFFFF0000 to 0xFFFF07FFF) Reserved area
- (2) Block 75 (0xFFE00000 to 0xFFE07FFF) Data storage area

In addition, it is recommended to store the data for two banks as the certification information setting data for safety, but this demo program is configured to operate with the data for one bank due to the program size.

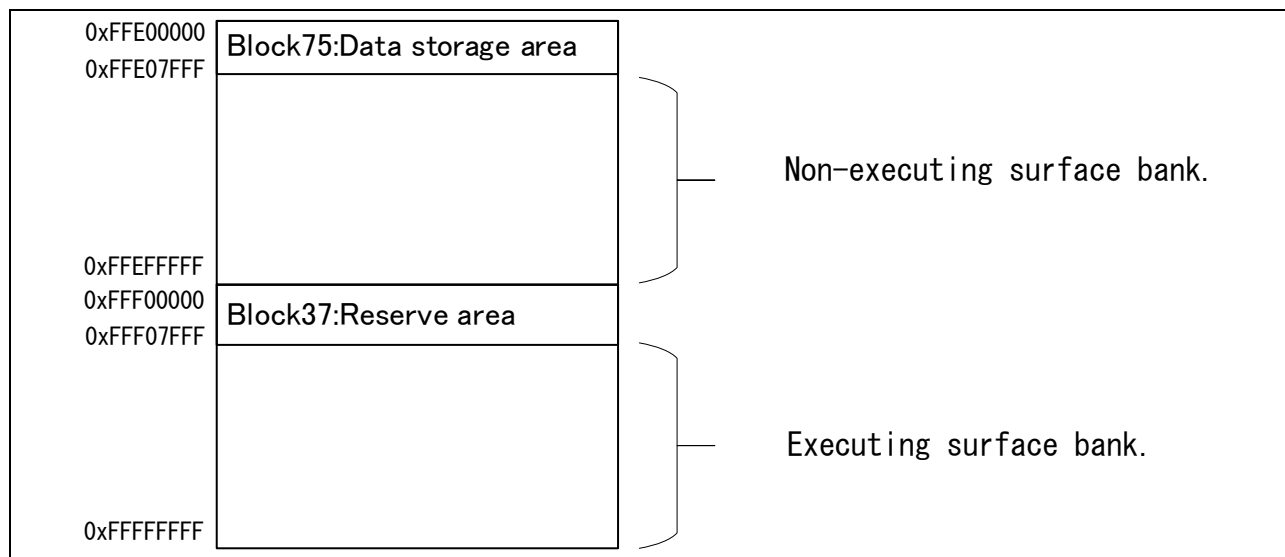

Figure 3-16 Certification Information Stored Mapping

#### 4. Starting the Demo for Standalone Version

In the standalone version, after writing the program, disconnect the E2 emulator Lite connector and turn on the Renesas Starter Kit+ for RX671 board to start the demo program. This demo program assumes the remote control of the air conditioner and displays the power on / off, temperature setting, and switching of heating and cooling on the LCD. In the demo, you can use button 2, slider on the touch panel, and switch 3 (SW3).

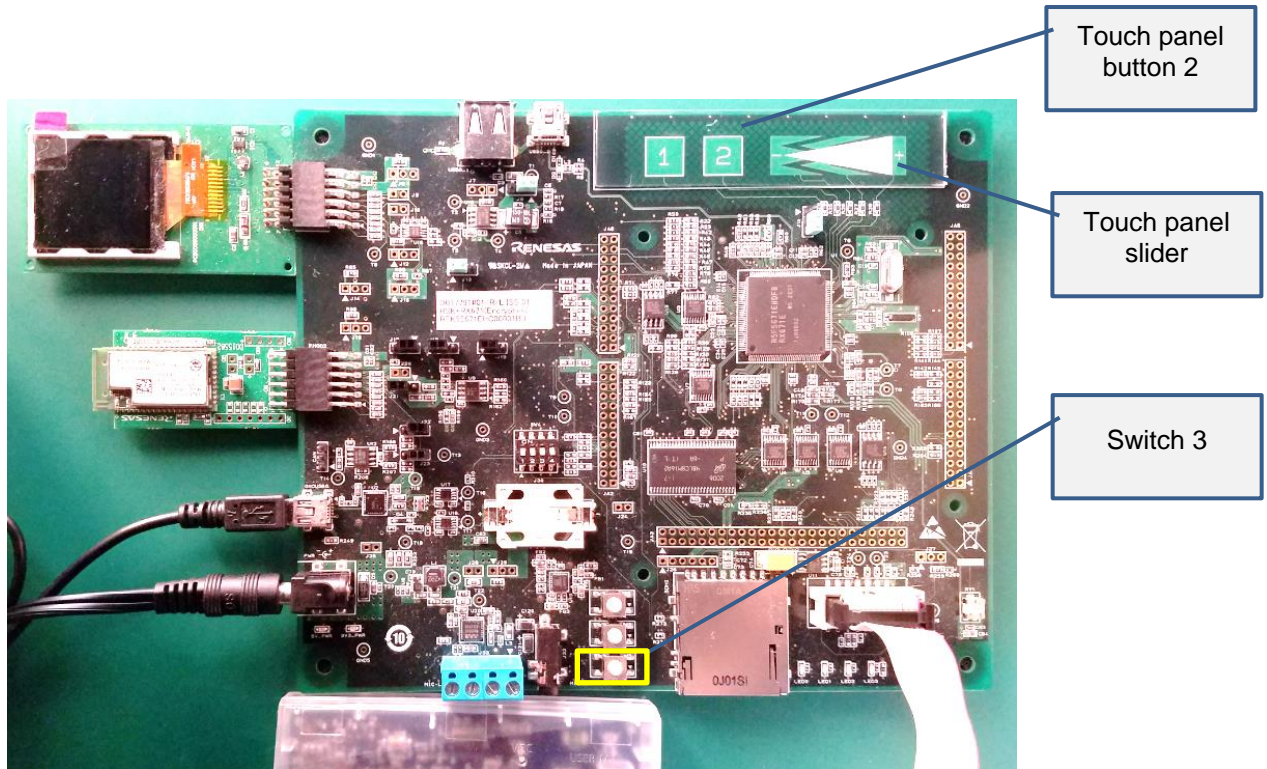

Figure 4-1 Hardware Connection

#### 4.1 Renesas Starter Kit+ for RX671 Power on to Voice Command Standby Screen

When the power of the Renesas Starter Kit+ for RX671 is turned on, the RX logo mark and the features of the RX671 are displayed on the LCD panel for about 2 seconds. When the display ends, the demo program starts and the screen changes to the voice command standby screen.

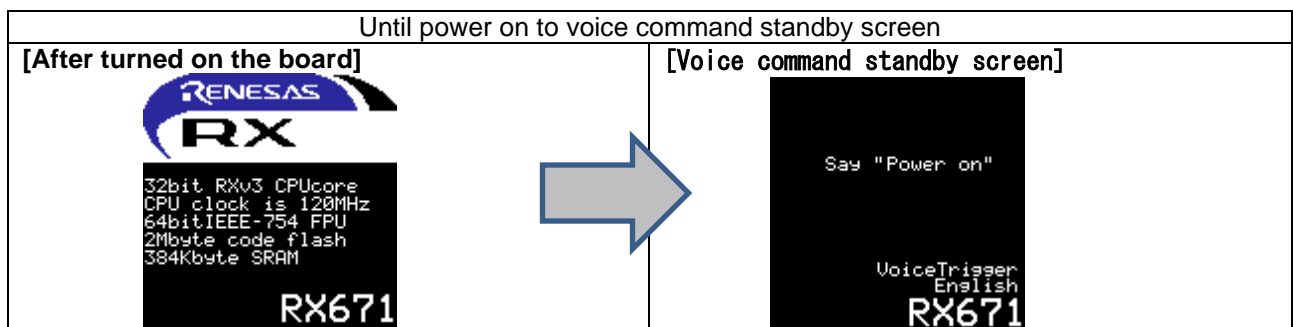

Figure 4-2 After power on



## 4.2 Selecting the Language Mode of Renesas Starter Kit+ for RX671

You can switch the recognized language by pressing SW3. Each time you press SW3, Japanese and English alternate. The first language the demo program recognizes is English. In this manual, explanations will be given in English.

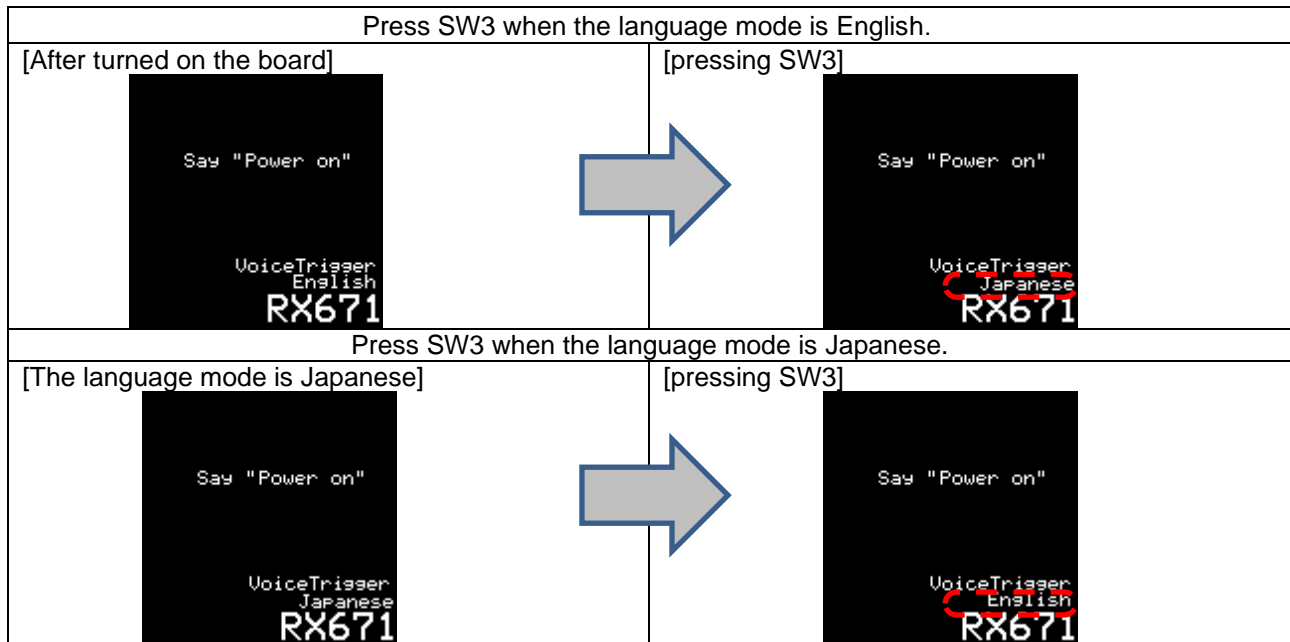

Figure 4-3 How to Switch the Language

### 4.2.1 Acceptable Voice Commands

The table below shows a list of voice commands.

Table 4.1 List of Voice Commands

Voice commands		Functions
English	Japanese	
Power on	でんげんおん	Assuming that the air conditioner is turned on, the LCD is displayed.
Power off	でんげんおふ	Assuming that the air conditioner is turned off, the LCD is blacked out.
Heating mode	だんぼうモード	Assuming the heating operation of the air conditioner, the heating is displayed.
Air conditioning mode	れいぼうモード	Assuming the cooling operation of the air conditioner, the cooling is displayed.
Raise the temperature	おんどをあげて	Only when the LCD is on, raise the set temperature by 1°C. The upper limit is 28°C.
Lower the temperature	おんどをさげて	Only when the LCD is on, lower the set temperature by 1°C. The lower limit is 16°C.
Sixteen degrees ~Twenty-eight degrees	じゅうろくど ~にじゅうはちど	Only when the LCD is on, the specified temperature is displayed as the set temperature.

### 4.3 Possible Functions on the Standby Screen After the Board is Turned On

After recognizing the voice command "Power on", the air conditioner mode demo will start.

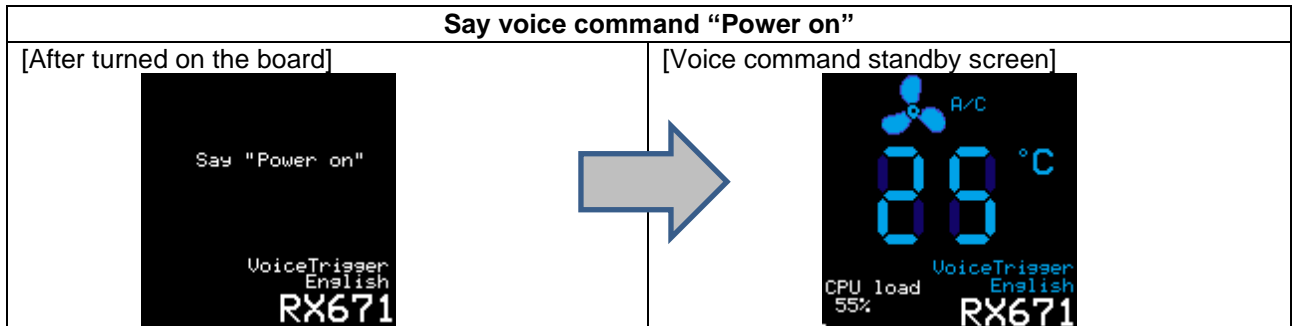

Figure 4-4 LCD Screen After "Power on"

### 4.4 Possible Functions on Air Conditioner Mode

#### 4.4.1 Change the Set Temperature

The set temperature of the air conditioner can be changed with the slider or voice command. The set temperature range is from 16°C to 28°C. If you trace the slider from left to right or say "Raise the temperature", the set temperature will be raised by 1°C. And if you trace the slider from right to left or say "Lower the temperature", the set temperature will be lowered by 1°C. In addition, you can directly specify the set temperature by voice command from "Sixteen degrees" to "Twenty-eight degrees".

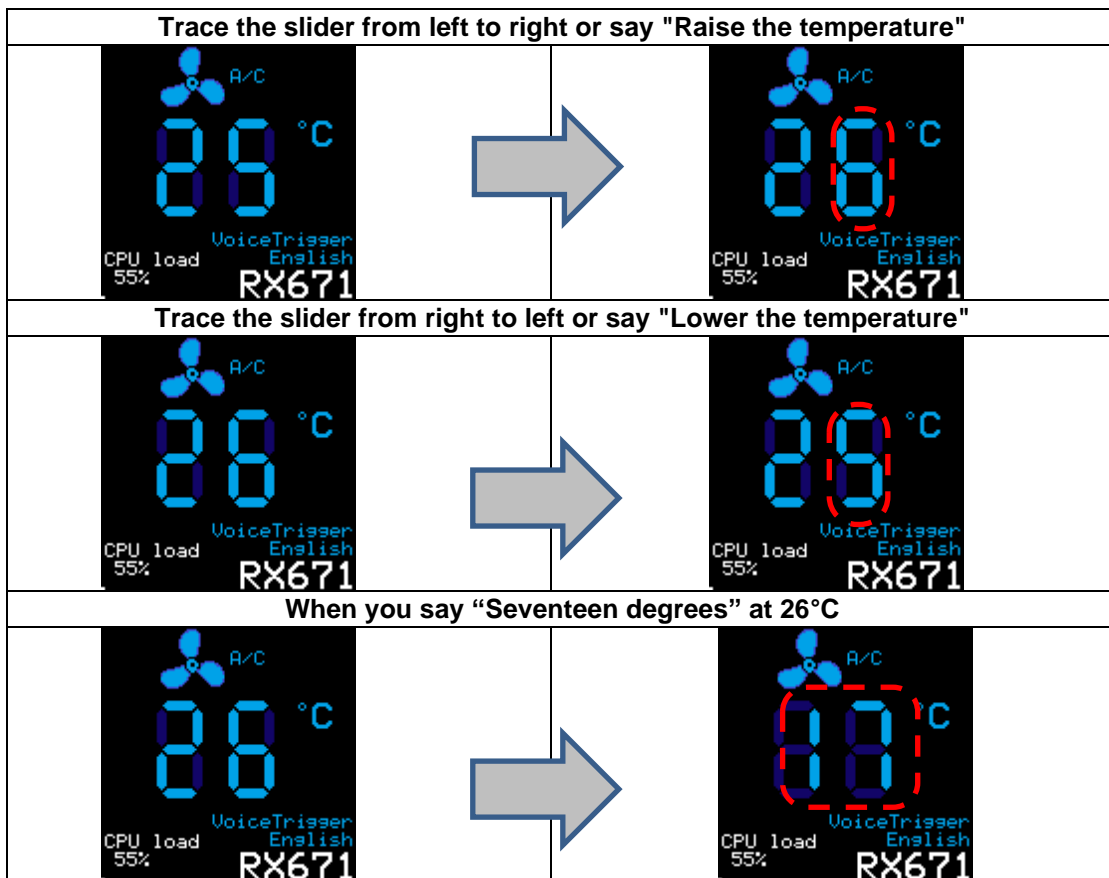

Figure 4-5 Setting Method for Temperature

### 4.4.2 Switching Between Heating and Cooling

You can switch between heating mode and cooling mode only by voice command.

Speaking "Heating mode" will switch to heating mode and speaking "Air conditioning mode" will switch to cooling mode.

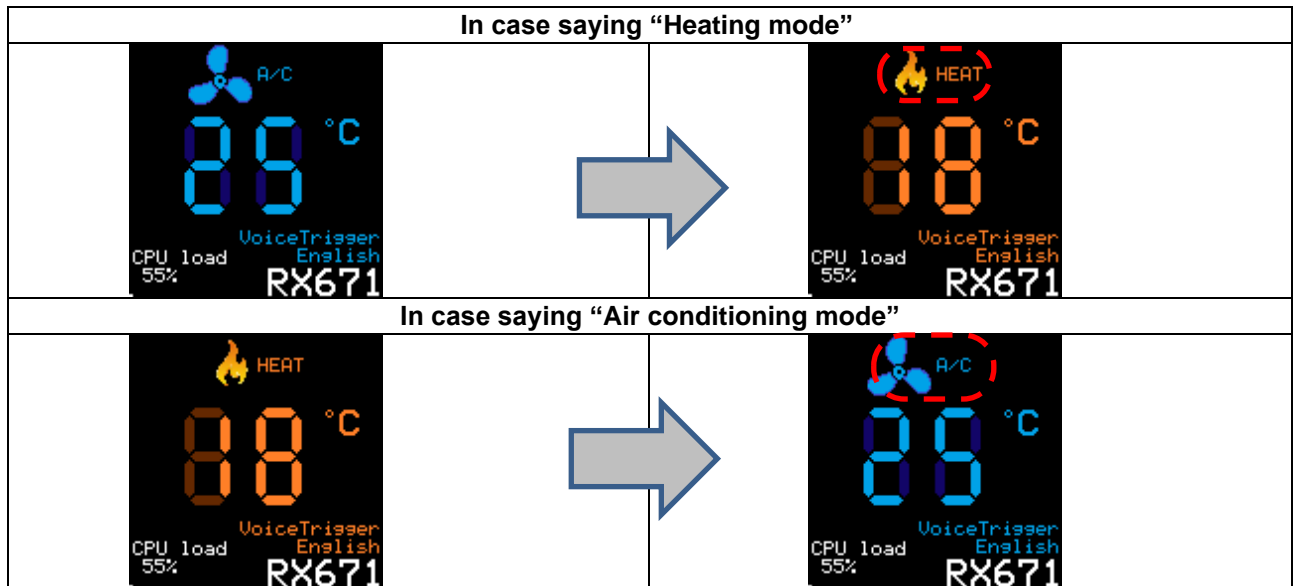

Figure 4-6 Switching Between Heating Mode and Cooling Mode

### 4.4.3 Power Off of Air Conditioner

When you say "Power off", the LCD turns off as if the air conditioner was turned off.

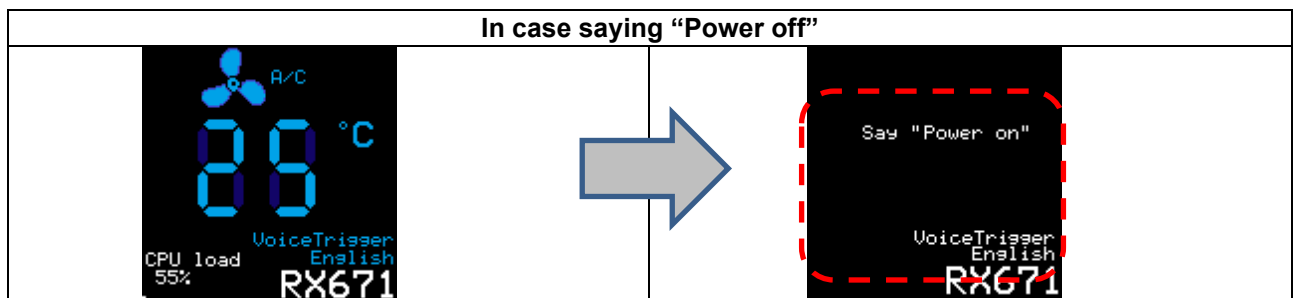

Figure 4-7 Power Off

## 4.5 Parameter Setting Function of Voice Recognition Engine

You can switch the parameters of the voice recognition engine during the demo.

### 4.5.1 Types of Parameters that can be Set

The parameters that can be set with the parameter setting function and the explanation of the parameters are as follows.

**Table 4.2 Parameter Types (Voice Trigger)**

Voice Trigger			
Parameter	Initial value	Available value	Meaning
Threshold	400	300,400,500,600	Set the voice detection threshold. Increasing the value makes it easier to detect, but also increases false detections.
silDiscount	600	500,600,700,800	If the voice contains silence, the words before and after the silence may be falsely detected as two words. Increasing the value will make word splitting less likely to occur due to silence, but will slow down the detection response. Decreasing the value makes word splitting more likely, but improves detection response speed.
Frame skip	0	0,3,6,12	This parameter is set when you want to reduce the CPU load. Some of the operations performed for each frame, some processing with a large amount of operation is performed for each set value + 1 frame. If the value is 0 (initial value), all processing is performed in units of every frame, but if the value is set to 3, processing with a large amount of calculation is performed every three processing.

**Table 4.3 Parameter Types (AmiVoice®)**

AmiVoice®			
Parameter	Initial value	Available value	Meaning
Threshold	10000	5000,7000,10000,13000	Speaking detection threshold of AmiVoice® The larger the value, the lower the detection, and the fewer false detections.
Confidence	100	80,100,150,200	Confidence threshold of AmiVoice® The larger the value, the lower the detection, and the fewer false detections.

**Table 4.4 Parameter Types (Zoom Voice)**

Zoom Voice			
Parameter	Initial value	Available value	Meaning
Beam forming	3	1,3,5,7	Beam forming amount of Zoom Voice. The larger the value, the higher the directivity.
Noise suppressor	3	1,3,5,7	Noise suppression amount of Zoom Voice. The larger the value, the higher the noise tolerance.

**4.5.2 How to Start Parameter Setting Screen**

Press and hold button 2 on the touch panel (for about 3 seconds) to display the parameter setting screen. For example, in the case of Voice Trigger Threshold, you can select from 4 types such as 600⇒700⇒800⇒500⇒600 by tracing the slider from left to right.

In addition, the parameters to be set can be switched each time the button 2 on the touch panel is pressed. For example, in the case of voice trigger, you can select from 3 types such as Threshold ⇒ silDiscount ⇒ Frame skip.

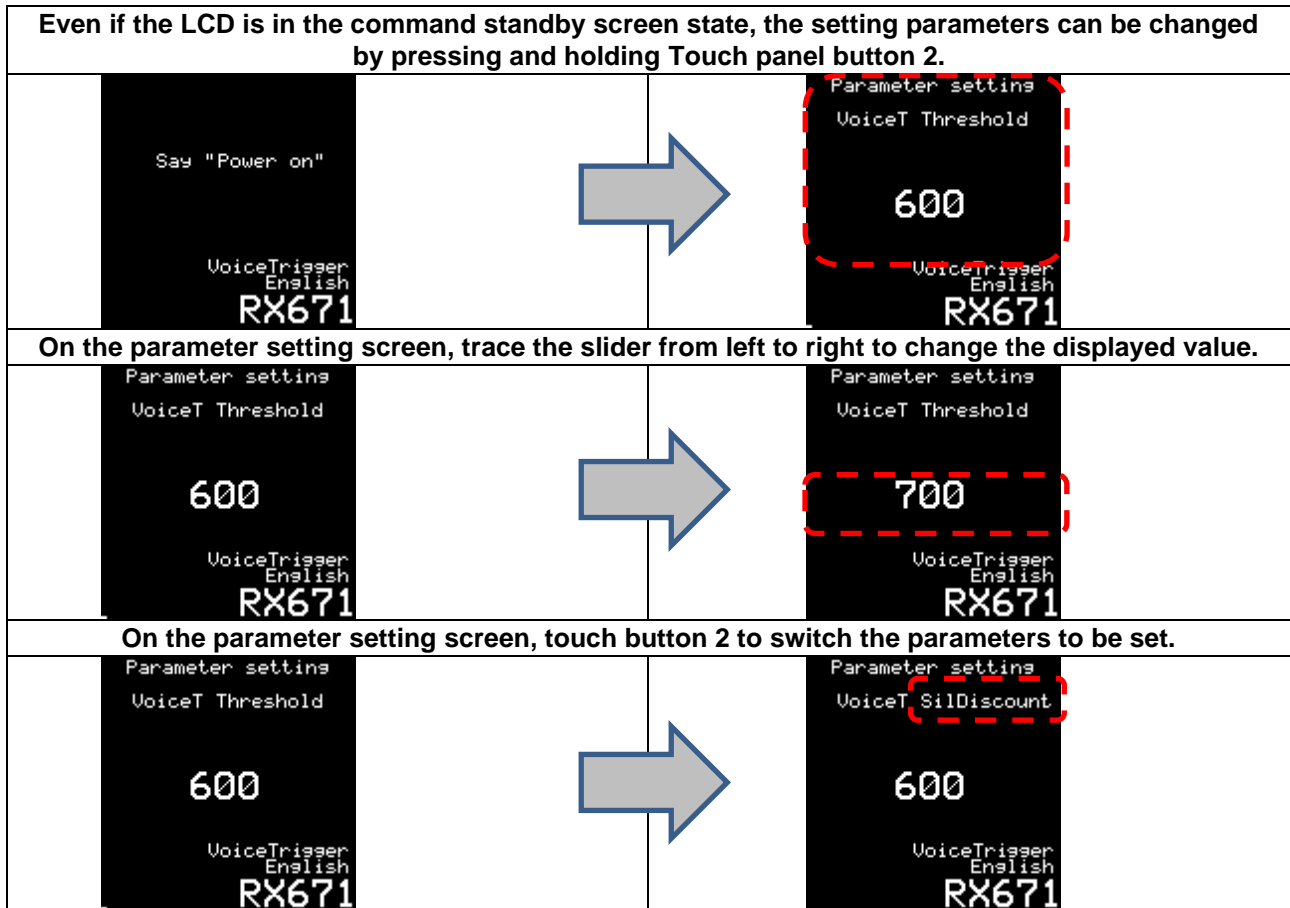

Figure 4-8 Parameter Change

## 5. Starting the Demo for Cloud Version

In the cloud version demo, it is necessary to set the certification information in advance. Please refer to "3.4 Setting for Certification (Cloud version only)" and set.

The cloud version demo uses buttons 2, sliders on the touch panel, and switch 1 (SW1), switch 2 (SW2), and switch 3 (SW3). When running the demo program, disconnect the E2 emulator Lite connector. The cloud version demo can be run by holding down SW1 or SW2 and powering on the Renesas Starter Kit+ for RX671 board. Keep pressing the switch for about 1 second after turning on the power.

When you turn on the power of the Renesas Starter Kit+ for RX671 board while pressing SW1, the demo will start in the certification information setting mode as described in "3.4 Setting for Certification (Cloud version only)".

Hold down SW2 and power on the Renesas Starter Kit+ for RX671 board to start the demo with the previously written certification information.

Powering on the Renesas Starter Kit+ for RX671 board without pressing any switch will start the demo in the standalone mode.

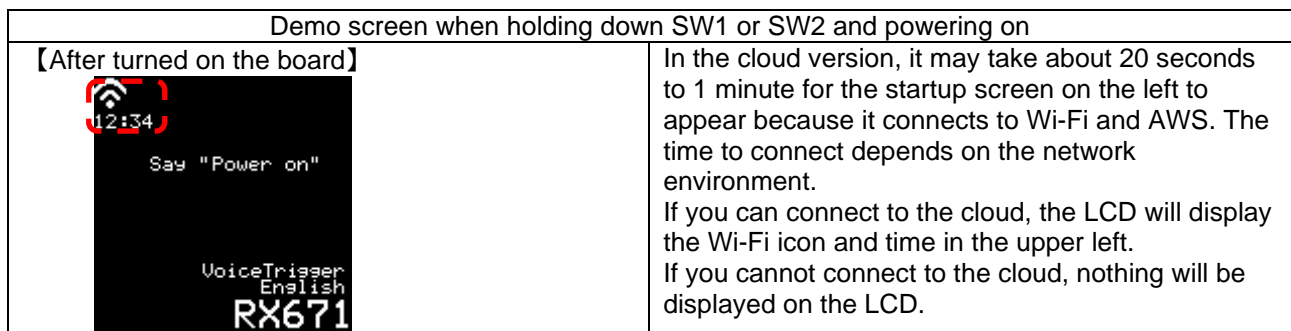

Figure 5-1 LCD Display Example When Connected to the Cloud

### 5.1 Operation for Touch Interface and Voice Interface

For voice operation and touch operation, refer to "4.Starting the Demo for Standalone Version ".

### 5.2 shadow

This section describes how to use the AWS IoT Core shadow service to control an edge device (RX65N Cloud Kit) from the cloud.

The shadow service can be used not only to collect data from edge devices, but also to control edge devices from the cloud. By controlling the product remotely, it is possible to realize a variety of application requests. In this demo, you can change the set temperature and the operation mode (heating, cooling). You can also control the turn on / off of the LED.

### 5.3 Device Properties

The table below lists the device properties used by the demo.

**Table 5-1 Device Properties**

Property	Status	Operation
"LCDControl"	"LCD_ON"	Power on the PMOD-LCD
	"LCD_OFF"	Power off the PMOD-LCD
"AirControlMode"	"AC"	Change to Air conditioning mode
	"HEAT"	Change to Heating mode
"TemperatureSet"	16~28	Change the set temperature
"Temperature"	(None)	Display of current temperature (dummy data)
"LEDControl"	"LED_ON"	Turn on the board LED
	"LED_OFF"	Turn off the board LED

### 5.4 Operating Procedure of the shadow

The procedure for manipulating shadows is described below.

1. Perform all the steps listed in "3.4 Setting for Certification (Cloud version only)".
2. On the AWS Management Console, select **Services** → **All services** → **IoT** → **IoT Core**, then click **Test** → **Subscribe to a topic**, enter the following code.

```
$aws/things/xxxx/shadow/update
```

**Figure 5-2 Subscribe to a Topic**

Note: For xxxx, enter the name of the thing name registered in "3.3 Preparation of AWS (Cloud version only)".

3. Copy the following lines of code and paste them into the message payload field in Figure 5-3 (In this example the setting LED\_ON / Air conditioning mode / 25°C setting / LED\_ON are used, but you can make settings to tailor the operation to match the statuses listed in the Device Properties table.)

```
{
  "state": {
    "desired": {
      "LCDControl": "LCD_ON",
      "AirControlMode": "AC",
      "TemperatureSet": "25",
      "LEDControl": "LED_ON"
    }
  }
}
```

**Figure 5-3 Message Payload**

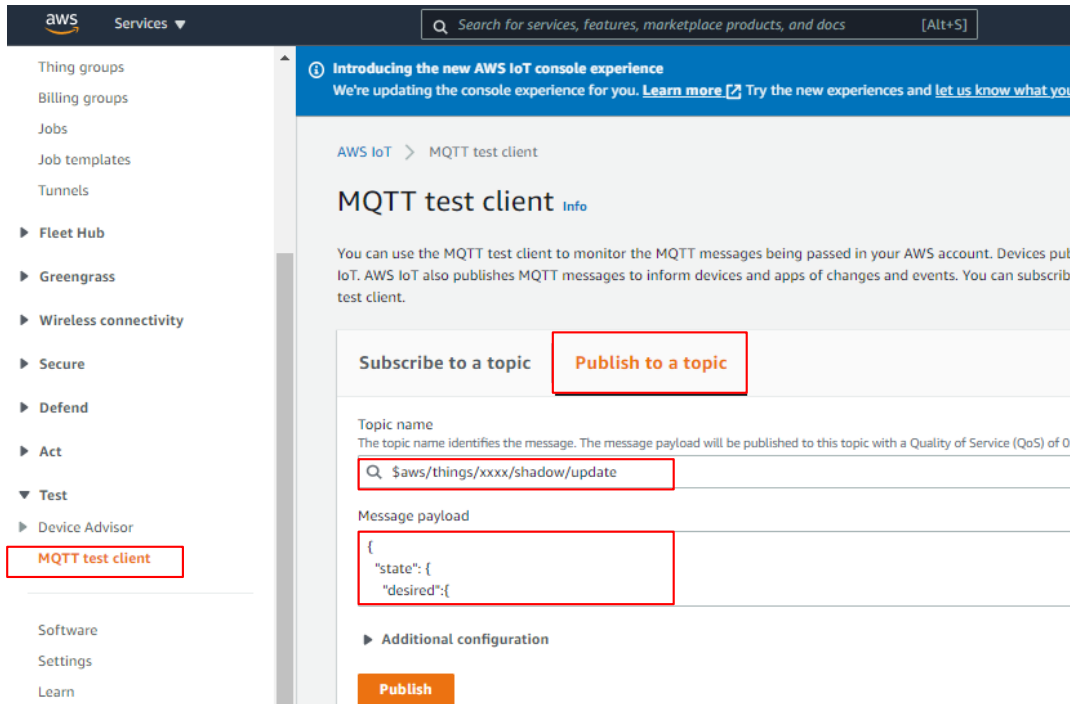

Figure 5-4 Publish to Topic

4. Click **Publish** and confirm that the PMOD-LCD module connected to the Renesas Starter Kit+ for RX671 is in A/C mode (displayed in blue) and the set temperature is 25°C.

5. Other operation examples are shown below.

```
{
  "state": {
    "desired": {
      "LCDControl": "LCD_ON"
    }
  }
}
```

Figure 5-5 Turn on LCD from AWS

```
{
  "state": {
    "desired": {
      "AirControlMode": "HEAT"
    }
  }
}
```

Figure 5-6 Set the Operating Mode to Heating Mode from AWS



### 5.5 Data Confirmation by AWS

Here is how to check the data uploaded to AWS.

Go to AWS Services → All Services → IoT → IoT Core and go to Things.

The name of the thing registered in "3.4 Setting for Certification (Cloud version only)" is displayed, so click it.

Furthermore, if you click Device Shadow on the transition destination screen, you can check the most recently uploaded data.

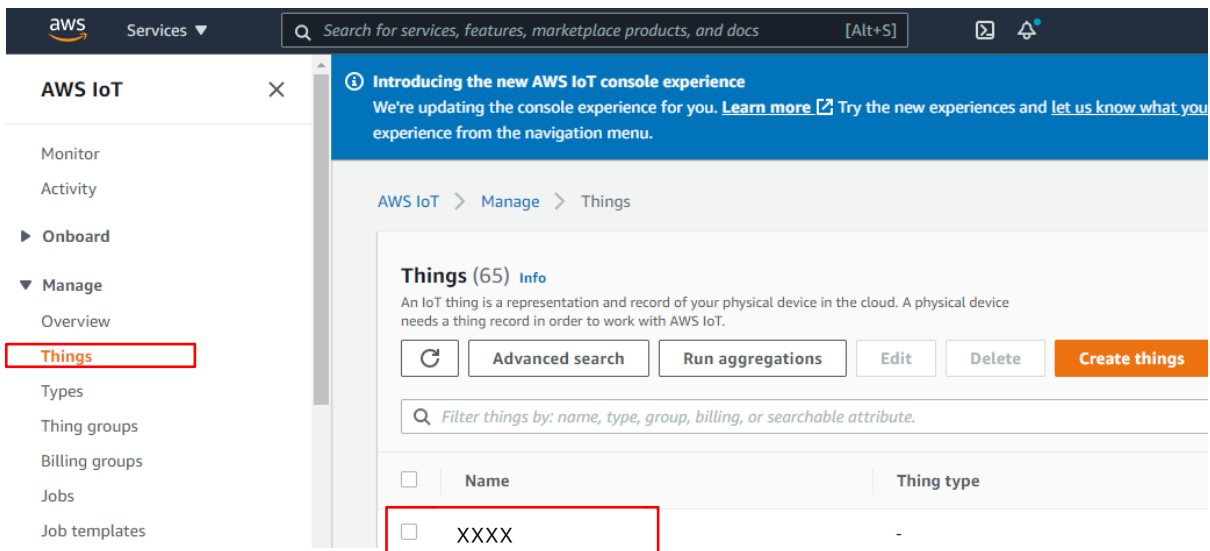

Figure 5-7 How to Check the Data Uploaded to AWS

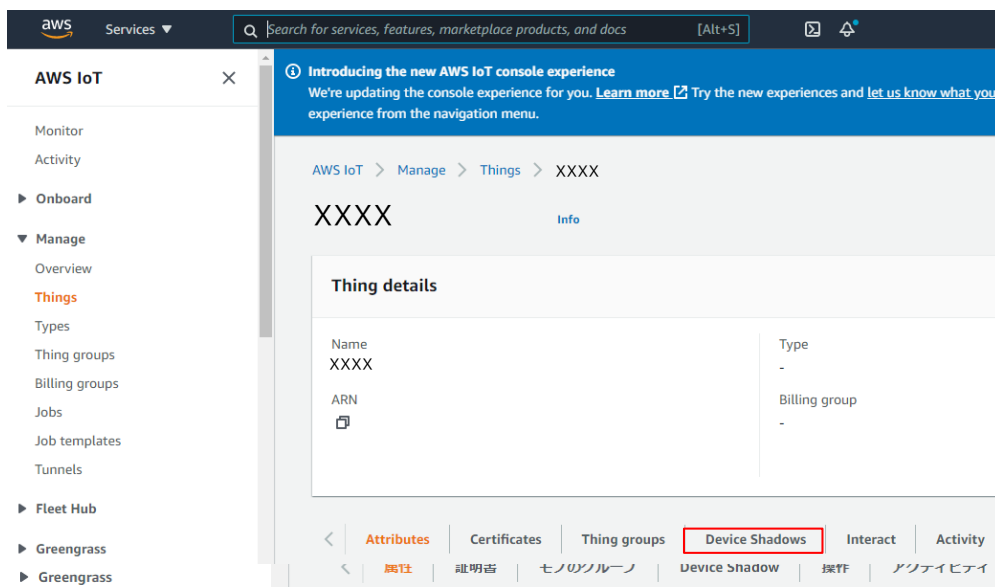

Figure 5-8 Device Shadow

## 6. Confirmed Conditions of the Operation

### 6.1 Confirmed Conditions of the Operation

The sample code of this application has been confirmed to work under the conditions shown in Table 6.1

**Table 6.1 Confirmed Conditions of the Operation**

Items		Conditions
MCU		R5F5671EHDFB 144-pin LQFP
		Internal ROM 2MB, Internal RAM 384KB
Operating frequency		Main clock oscillator: External 24MHz (Internal: 120MHz)
Power supply		USB connector: 5V Input
		Power IC: 5V Input, 3.3V Output
		External power supply jack: 5.0V Input (Φ2.1mm)
IDE (Integrated Development Environment)		Renesas e <sup>2</sup> studio 2021-07
C compiler		CC-RX V3.03.00
FreeRTOS		202012.00
Debugger		E2 emulator Lite
Parts of demo	Target board Wi-Fi Pmod Expansion Board	Renesas Starter Kit+ for RX671 RTK00WFMX0B00000BE
Version of the sample code		Rev.1.00

## 6.2 Memory Size

The ROM size used in this sample code is shown in Table 6.2, and the RAM size is shown in Table 6.3. (At optimization level 2)

**Table 6.2 ROM Size**

Size (KB)	Description.
535	OS & Renesas drivers
110	Voice recognition control (AmiVoice+TMC or Voice Trigger)
262	Voice recognition dictionary (English and Japanese) *1
80	LCD control & pictures
7	others
Total 994KB	

**Table 6.3 RAM Size**

Size (KB)	Description.
75	OS & Renesas drivers
130	OS HEAP
81	System HEAP (Voice recognition 60KB)
21	Stack (USTACK: 20KB (Voice recognition), ISTACK:1K)
36	Voice recognition (recoding buffer: 20KB, other)
Total 343KB	



## 8. Reference Documents

### User's Manual: Hardware

RX671 Group User's Manual: Hardware R01UH0899EJ0100

(Get the latest version from the Renesas Electronics website.)

### User's Manual: Renesas Starter Kit+

Renesas Starter Kit+ for RX671 R20UT4879EG0100

(Get the latest version from the Renesas Electronics website.)

## 9. Notice for Board Modification

The cloud version requires modification of the board of Renesas Starter Kit+ for RX671 for operation. We recommend that you modify according to "2.2 About Renesas Starter Kit board modification (cloud version only)".

Modifications require the removal of multiple chip resistors. In this chapter, if you want to avoid modifying the board of Renesas Starter Kit+ for RX671 as much as possible, we will show you how to operate this demo by connecting several aerial wires and removing one chip resistor.

The one chip resistor R189 to be removed is shorted to the CAN-RX signal of the CAN transceiver TJA1044GT / 3Z. If it is connected, it will be affected by the CAN transceiver signal and communication will not be performed correctly.

It can be wired by aerial wiring.

PMOD2 pin No.	Destination to connect
PMOD2.2 (2pin)	J18 Pin2
PMOD2.3 (3pin)	J21 Pin2
PMOD2.4 (4pin)	J19 Pin2
PMOD2.9 (9pin)	J23 Pin2
PMOD2.10 (10pin)	J22 Pin2

If you run other applications with this modification, the board may be damaged. Be sure to return to the state before modification after execution.

**Revision History**

Rev.	Date	Description	
		Page	Summary
1.00	2021/8/31	-	First edition issued
-	-	-	-

# General Precautions in the Handling of Microprocessing Unit and Microcontroller Unit Products

The following usage notes are applicable to all Microprocessing unit and Microcontroller unit products from Renesas. For detailed usage notes on the products covered by this document, refer to the relevant sections of the document as well as any technical updates that have been issued for the products.

## 1. Precaution against Electrostatic Discharge (ESD)

A strong electrical field, when exposed to a CMOS device, can cause destruction of the gate oxide and ultimately degrade the device operation. Steps must be taken to stop the generation of static electricity as much as possible, and quickly dissipate it when it occurs. Environmental control must be adequate. When it is dry, a humidifier should be used. This is recommended to avoid using insulators that can easily build up static electricity.

Semiconductor devices must be stored and transported in an anti-static container, static shielding bag or conductive material. All test and measurement tools including work benches and floors must be grounded. The operator must also be grounded using a wrist strap. Semiconductor devices must not be touched with bare hands. Similar precautions must be taken for printed circuit boards with mounted semiconductor devices.

## 2. Processing at power-on

The state of the product is undefined at the time when power is supplied. The states of internal circuits in the LSI are indeterminate and the states of register settings and pins are undefined at the time when power is supplied. In a finished product where the reset signal is applied to the external reset pin, the states of pins are not guaranteed from the time when power is supplied until the reset process is completed. In a similar way, the states of pins in a product that is reset by an on-chip power-on reset function are not guaranteed from the time when power is supplied until the power reaches the level at which resetting is specified.

## 3. Input of signal during power-off state

Do not input signals or an I/O pull-up power supply while the device is powered off. The current injection that results from input of such a signal or I/O pull-up power supply may cause malfunction and the abnormal current that passes in the device at this time may cause degradation of internal elements. Follow the guideline for input signal during power-off state as described in your product documentation.

## 4. Handling of unused pins

Handle unused pins in accordance with the directions given under handling of unused pins in the manual. The input pins of CMOS products are generally in the high-impedance state. In operation with an unused pin in the open-circuit state, extra electromagnetic noise is induced in the vicinity of the LSI, an associated shoot-through current flows internally, and malfunctions occur due to the false recognition of the pin state as an input signal become possible.

## 5. Clock signals

After applying a reset, only release the reset line after the operating clock signal becomes stable. When switching the clock signal during program execution, wait until the target clock signal is stabilized. When the clock signal is generated with an external resonator or from an external oscillator during a reset, ensure that the reset line is only released after full stabilization of the clock signal. Additionally, when switching to a clock signal produced with an external resonator or by an external oscillator while program execution is in progress, wait until the target clock signal is stable.

## 6. Voltage application waveform at input pin

Waveform distortion due to input noise or a reflected wave may cause malfunction. If the input of the CMOS device stays in the area between  $V_{IL}$  (Max.) and  $V_{IH}$  (Min.) due to noise, for example, the device may malfunction. Take care to prevent chattering noise from entering the device when the input level is fixed, and also in the transition period when the input level passes through the area between  $V_{IL}$  (Max.) and  $V_{IH}$  (Min.).

## 7. Prohibition of access to reserved addresses

Access to reserved addresses is prohibited. The reserved addresses are provided for possible future expansion of functions. Do not access these addresses as the correct operation of the LSI is not guaranteed.

## 8. Differences between products

Before changing from one product to another, for example to a product with a different part number, confirm that the change will not lead to problems. The characteristics of a microprocessing unit or microcontroller unit products in the same group but having a different part number might differ in terms of internal memory capacity, layout pattern, and other factors, which can affect the ranges of electrical characteristics, such as characteristic values, operating margins, immunity to noise, and amount of radiated noise. When changing to a product with a different part number, implement a system-evaluation test for the given product.



## Notice

1. Descriptions of circuits, software and other related information in this document are provided only to illustrate the operation of semiconductor products and application examples. You are fully responsible for the incorporation or any other use of the circuits, software, and information in the design of your product or system. Renesas Electronics disclaims any and all liability for any losses and damages incurred by you or third parties arising from the use of these circuits, software, or information.
2. Renesas Electronics hereby expressly disclaims any warranties against and liability for infringement or any other claims involving patents, copyrights, or other intellectual property rights of third parties, by or arising from the use of Renesas Electronics products or technical information described in this document, including but not limited to, the product data, drawings, charts, programs, algorithms, and application examples.
3. No license, express, implied or otherwise, is granted hereby under any patents, copyrights or other intellectual property rights of Renesas Electronics or others.
4. You shall not alter, modify, copy, or reverse engineer any Renesas Electronics product, whether in whole or in part. Renesas Electronics disclaims any and all liability for any losses or damages incurred by you or third parties arising from such alteration, modification, copying or reverse engineering.
5. Renesas Electronics products are classified according to the following two quality grades: "Standard" and "High Quality". The intended applications for each Renesas Electronics product depends on the product's quality grade, as indicated below.  
"Standard": Computers; office equipment; communications equipment; test and measurement equipment; audio and visual equipment; home electronic appliances; machine tools; personal electronic equipment; industrial robots; etc.  
"High Quality": Transportation equipment (automobiles, trains, ships, etc.); traffic control (traffic lights); large-scale communication equipment; key financial terminal systems; safety control equipment; etc.  
Unless expressly designated as a high reliability product or a product for harsh environments in a Renesas Electronics data sheet or other Renesas Electronics document, Renesas Electronics products are not intended or authorized for use in products or systems that may pose a direct threat to human life or bodily injury (artificial life support devices or systems; surgical implantations; etc.), or may cause serious property damage (space system; undersea repeaters; nuclear power control systems; aircraft control systems; key plant systems; military equipment; etc.). Renesas Electronics disclaims any and all liability for any damages or losses incurred by you or any third parties arising from the use of any Renesas Electronics product that is inconsistent with any Renesas Electronics data sheet, user's manual or other Renesas Electronics document.
6. When using Renesas Electronics products, refer to the latest product information (data sheets, user's manuals, application notes, "General Notes for Handling and Using Semiconductor Devices" in the reliability handbook, etc.), and ensure that usage conditions are within the ranges specified by Renesas Electronics with respect to maximum ratings, operating power supply voltage range, heat dissipation characteristics, installation, etc. Renesas Electronics disclaims any and all liability for any malfunctions, failure or accident arising out of the use of Renesas Electronics products outside of such specified ranges.
7. Although Renesas Electronics endeavors to improve the quality and reliability of Renesas Electronics products, semiconductor products have specific characteristics, such as the occurrence of failure at a certain rate and malfunctions under certain use conditions. Unless designated as a high reliability product or a product for harsh environments in a Renesas Electronics data sheet or other Renesas Electronics document, Renesas Electronics products are not subject to radiation resistance design. You are responsible for implementing safety measures to guard against the possibility of bodily injury, injury or damage caused by fire, and/or danger to the public in the event of a failure or malfunction of Renesas Electronics products, such as safety design for hardware and software, including but not limited to redundancy, fire control and malfunction prevention, appropriate treatment for aging degradation or any other appropriate measures. Because the evaluation of microcomputer software alone is very difficult and impractical, you are responsible for evaluating the safety of the final products or systems manufactured by you.
8. Please contact a Renesas Electronics sales office for details as to environmental matters such as the environmental compatibility of each Renesas Electronics product. You are responsible for carefully and sufficiently investigating applicable laws and regulations that regulate the inclusion or use of controlled substances, including without limitation, the EU RoHS Directive, and using Renesas Electronics products in compliance with all these applicable laws and regulations. Renesas Electronics disclaims any and all liability for damages or losses occurring as a result of your noncompliance with applicable laws and regulations.
9. Renesas Electronics products and technologies shall not be used for or incorporated into any products or systems whose manufacture, use, or sale is prohibited under any applicable domestic or foreign laws or regulations. You shall comply with any applicable export control laws and regulations promulgated and administered by the governments of any countries asserting jurisdiction over the parties or transactions.
10. It is the responsibility of the buyer or distributor of Renesas Electronics products, or any other party who distributes, disposes of, or otherwise sells or transfers the product to a third party, to notify such third party in advance of the contents and conditions set forth in this document.
11. This document shall not be reprinted, reproduced or duplicated in any form, in whole or in part, without prior written consent of Renesas Electronics.
12. Please contact a Renesas Electronics sales office if you have any questions regarding the information contained in this document or Renesas Electronics products.

(Note1) "Renesas Electronics" as used in this document means Renesas Electronics Corporation and also includes its directly or indirectly controlled subsidiaries.

(Note2) "Renesas Electronics product(s)" means any product developed or manufactured by or for Renesas Electronics.

(Rev.4.0-1 November 2017)

## Corporate Headquarters

TOYOSU FORESIA, 3-2-24 Toyosu,  
Koto-ku, Tokyo 135-0061, Japan  
[www.renesas.com](http://www.renesas.com)

## Trademarks

Renesas and the Renesas logo are trademarks of Renesas Electronics Corporation. All trademarks and registered trademarks are the property of their respective owners.

## Contact information

For further information on a product, technology, the most up-to-date version of a document, or your nearest sales office, please visit:  
[www.renesas.com/contact/](http://www.renesas.com/contact/).