RA4W1 Group APPLICATION NOTE

R11AN0488EJ0100

Environmental sensor network solution control

Rev.1.00

sample software for building / HVAC

Feb.10.21

Introduction

This document describes environmental sensor network solution control sample software for building / HVAC using RA4W1, ZMOD4410 (IAQ), HS3001 (Humidity &Temp. Sensor).

This application note can be used for different purposes.

- Those who want to run the demo environment

See Chapter 2, 3, and 5.

- Those who want to develop using the demo project

See from Chapter 1.

Target Device

RA4W1Group

Contents

1. Overview.....	4
2. System overview	4
2.1 GUI operation mode	5
2.2 RA4W1 standalone mode	5
3. Hardware configuration	6
3.1 Hardware environment.....	6
4. RA4W1 software specifications	7
4.1 Overall software configuration.....	7
4.2 Firmware configuration for RA4W1	8
4.3 BLE Application	9
4.4 Application	9
4.5 BLE profile.....	10
4.5.1 Master profile.....	13
4.5.2 Slave profile.....	13
4.5.3 Characteristic common to Master and Slave	14
4.5.4 Pairing Settings	16
4.6 Sensor	17
4.6.1 ZMOD4410 (IAQ)	17
4.6.2 How to get the ZMOD4410 library.....	17
4.6.3 HS3001 (Humidity &Temp. Sensor).....	17
4.6.4 Sensor API function specifications.....	18
5. Build the environment.....	20
5.1 Board device connection example	20
5.1.1 How to connect when the USB power supply	20
5.1.2 How to connect when the AC adapter power supply	20
5.1.3 How to connect when the lithium-ion battery power supply	21
5.1.4 How to connect when connecting to the GUI.....	22
5.1.5 RA4W1 independent operation	22
5.1.6 Network construction.....	22
5.2 Development environment	23
5.2.1 How to install e2 studio	23
5.2.2 How to install FSP	23
5.2.3 How to import the e2studio project.....	23
5.2.4 GUI related installation	23
5.3 Run the demo project.....	23
5.4 Writing the Demo Project	24
5.5 Operation when connecting to GUI	25
5.5.1 Screen description.....	25
5.5.2 Demo Mode.....	35
5.5.3 Sensor Manufacturing Mode	47
5.5.4 Sensor Installation Mode.....	50

5.5.5	Sensor Operation Mode	56
5.5.6	Sensor Developer Mode.....	59
5.6	RA4W1 independent operation mode	65
6.	Appendex	66
6.1	HOST I/F communication specifications	66
6.2	Communication parameters	66
6.3	Communication sequence.....	66
6.3.1	Basic communication sequence.....	66
6.4	HOST I/F command specification overview	67
6.5	HOST I/F basic command format.....	68
6.6	HOST I/F command specifications.....	69
6.6.1	BLE network control	69
6.6.2	Sensor information display	71
6.6.3	Alarm Level setting / display.....	72
6.6.4	Configuration command	74
6.6.5	LED blinking command	75
	Revision History	76

1. Overview

This software is an environmental sensor network solution control sample software for building / HVAC using RA4W1, ZMOD4410 (IAQ), HS3001 (Humidity &Temp. Sensor).

By using this software, it is possible to collect IAQ (air quality) and humidity & temperature information of multiple devices using Bluetooth ® 5.0 Low Energy (BLE) communication.

A GUI customized for building / HVAC is prepared, in each phase of sensor development / manufacturing, sensor installation, and building operation, address setting to devices, pairing setting, sensor installation, alert notification for air quality, etc. can be realized.

By using this sample software, you can easily build an environmental sensing system suitable for building / HVAC.

2. System overview

In this demo project, RA4W1 can be connected to ZMOD4410 (IAQ) and HS3001 (Humidity &Temp. Sensor), and two types of operations can be performed depending on the device.

The BLE connection can be operated as a one-to-one connection between Master (client) and Slave (server), or as a one-to-many (up to 7 units) connection that can connect to multiple slaves (server) with one Master (client).

In this BLE connection, the address set in the devices is used for connection. There are two types of BLE addresses: public addresses and random addresses. In this application note, public addresses are described as MAC addresses and random addresses are described as devices addresses.

- GUI operation mode:

A mode in which a dedicated GUI and RA4W1 are connected, screens are selected from the GUI for each purpose (demo mode, sensor manufacturing mode, sensor installation mode, sensor operation mode, sensor developer mode are prepared), and each function is realized.

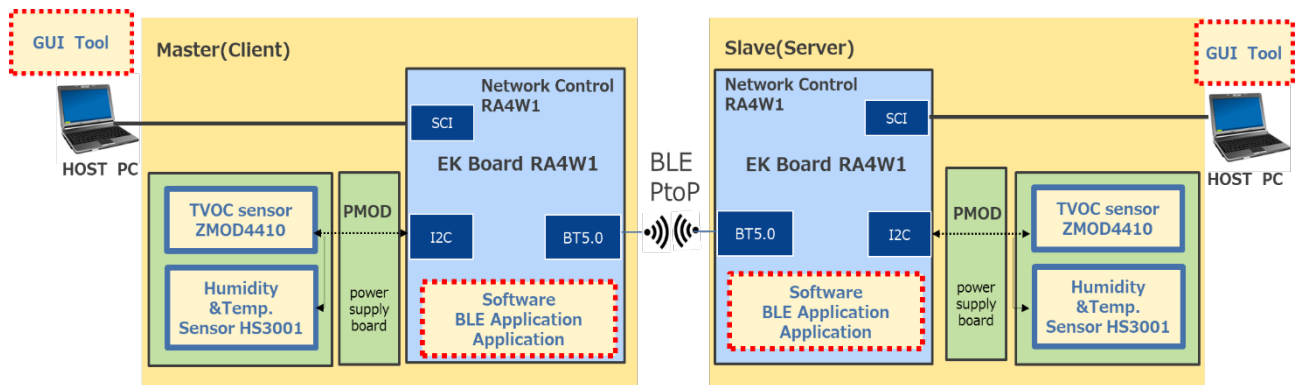

Figure 2-1 GUI operation mode

- RA4W1 standalone mode:

A mode to acquire the information of ZMOD4410 (IAQ) and HS3001 (Humidity &Temp. Sensor) by using BLE communication with RA4W1 alone.

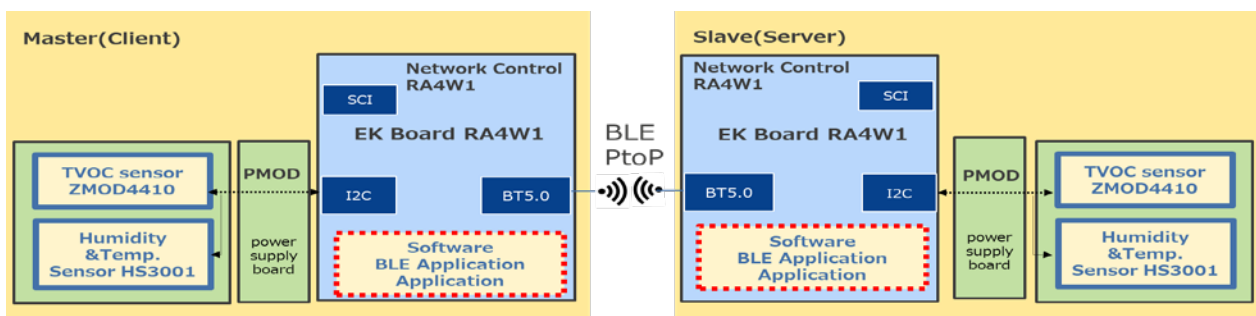

Figure 2-2 RA4W1 standalone mode

2.1 GUI operation mode

By connecting the dedicated GUI and RA4W1, the features for each purpose (demo mode, sensor manufacturing mode, sensor installation mode, sensor operation mode, sensor developer mode) are realized.

The following feature modes are available.

Demo mode:

This is a demonstration feature for those who explain this solution.

It is possible to build sensors and networks in the shortest possible time.

Sensor manufacturing mode:

This screen is for mass-produced workers of companies that manufacture sensors. You can set the MAC address or devices address of the sensor.

Sensor installation mode:

This mode is for installers who construction / installation / set sensors.

Sensor pairing, floor screen settings, and sensor placement are possible.

Sensor operation mode:

This mode is for building management / operators after installing the sensor.

You can check the sensor status and change the sensor threshold.

Sensor developer mode:

This mode is for professionals who can change the screen and detailed BLE settings of all modes such as production, installation, and operation.

2.2 RA4W1 standalone mode

With only RA4W1 and the sensor board without connecting to the GUI, you can make a one-to-one or one-to-many BLE connection and acquire the sensor value via BLE. The LED is turned on / off according to the TVOC level of the acquired sensor.

This mode stops working when a command is received from the GUI or serial console.

To return to RA4W1 standalone mode, press the reset button.

3. Hardware configuration

3.1 Hardware environment

The hardware environment used in this demo project is shown below.

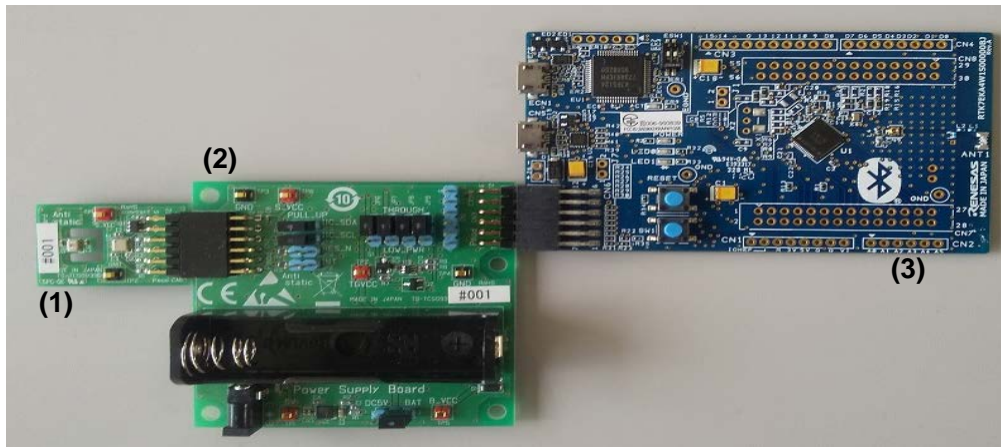

Figure 3-1 Hardware configuration description

Table 3-1 Hardware configuration description

Item	Content	Provider	Description
Board	EK RA4W1 Board	Renesas Electronics Corporation	RA4W1 MCU Group evaluation kit Figure 3-1 (3) *a
	TVOC GAS Sensor Board	TESSERA TECHNOLOGY	Board equipped with TVOC GAS sensor and Humidity &Temp. Sensor. The TVOC GAS sensor is equipped with ZMOD4410 made by Renesas Electronics Corporation. The Humidity &Temp. Sensor is equipped with HS3001 made by Renesas Electronics Corporation. Figure 3-1 (1) *b
	Power supply board		Since the external supply voltage by the AC adapter is 5V, a power conversion circuit (5V → 3V) is installed. Figure 3-1 (2) *b
PC for GUI	Windows10	-	edition : windows 10 pro bit : 64bit version :1909 OS build : 18363 .NET Framework : ver 4.6.1 Runtime : Microsoft Visual C++ 2015-2019 Redistributable (x86) : ver 14.25.28508
<p>*a Please contact Renesas Electronics Corporation for purchase.</p> <p>*b The board provider is TESSERA TECHNOLOGY. Please contact TESSERA TECHNOLOGY for purchase.</p>			

4. RA4W1 software specifications

4.1 Overall software configuration

Figure 4-1 shows the overall software configuration of this demo project.

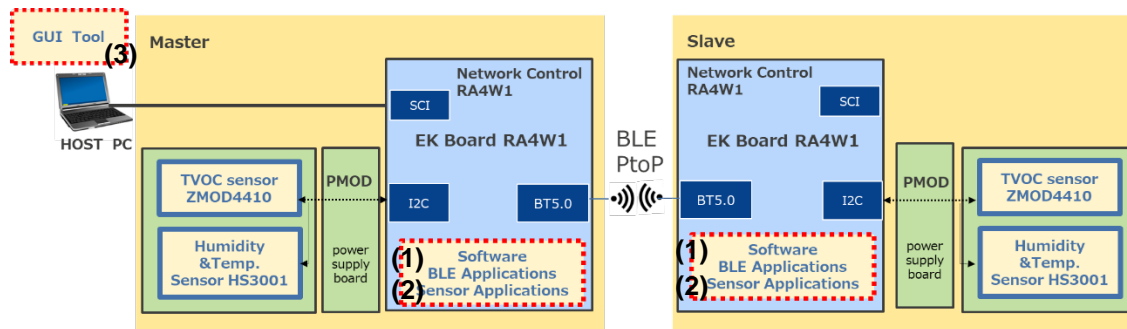

Figure 4-1 Overall software configuration

Table 4-1 Overall software configuration

Number	Name	Overview
(1)	Software (firmware for RA4W1) BLE Application	The firmware for RA4W1. Two types of operations are required for the Master and Slave, and the control is different for each. Each project file is prepared for Master and Slave.
(2)	Software (firmware for RA4W1) Sensor Application	The firmware for RA4W1. It is an application to get the value from TVOC, IAQ (ZMOD4410), Humidity &Temp. Sensor (HS3001).
(3)	GUI tool	GUI tool for Windows.

4.2 Firmware configuration for RA4W1

Figure 4-2 and Table 4-2 show the configuration of the RA4W1 firmware for this demo project.

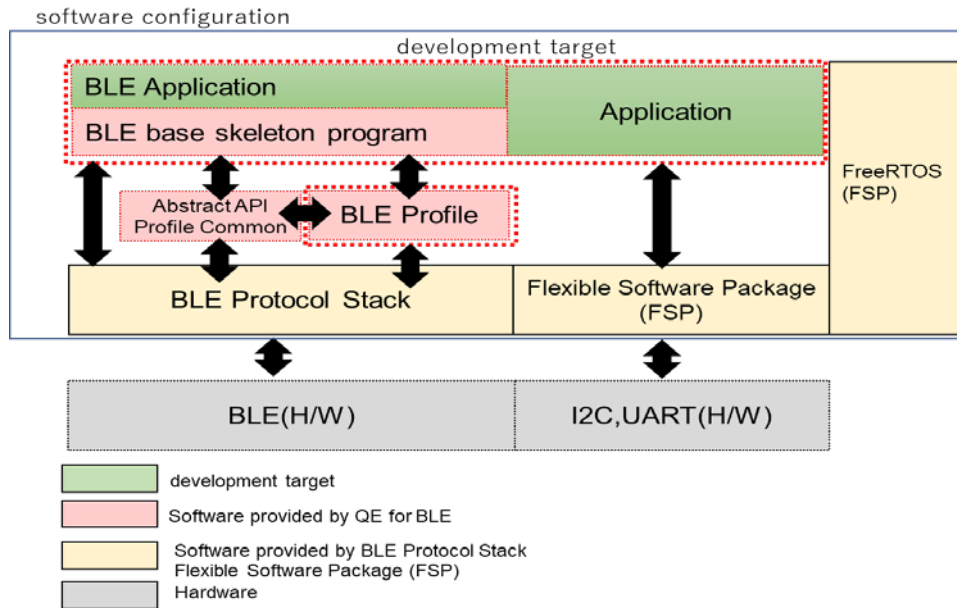

Figure 4-2 Software configuration (firmware for RA4W1)

Table 4-2 Software configuration (firmware for RA4W1)

Name	Feature overview
BLE Application	An application that controls the BLE Protocol Stack. For the BLE profile, use the original sensor. Two types of operations are required for Master and Slave, and the controls are different for each.
Application	An application such as sensor applications and HOSTI / F. The sensor application gets values from TVOC, IAQ (ZMOD4410), Humidity &Temp. Sensor (HS3001). HOSTI/F controls commands via GUI and serial communication.
BLE Profile	For BLE Profile, use the sensor original. Master operates as a client and Slave operates as a server.
BLE Protocol Stack	BLE Protocol Stack provided by Renesas Electronics Corporation .
Flexible Software Package (FSP)	Peripheral driver, Free RTOS and middleware stack provided by Renesas Electronics Corporation.
RTOS	Use Free RTOS.

4.3 BLE Application

Describes the BLE Application.

- For the demo project, prepare two types of projects, Master(client) and Slave(server).
- Master(client) connects to Slave(server) by BLE and gets the sensor value of Slave(server) via BLE.
- Slave(server) connects with Master(client) by BLE and returns the sensor value to Master(client) via BLE.

4.4 Application

Describes the application.

The application controls Sensor Application, HOST I/F, and so on.

The Sensor Application periodically gets values from the ZMOD4410, HS3001 sensor.

The basic control is the same for Master(client) and Slave(server).

For specific control, refer to Chapter 4.6.

HOSTI/F controls communication with the serial console and GUI.

4.5 BLE profile

(1) BLE profile

The BLE profile is shown in Figure 4-3.

* For the BLE profile, refer to the [Bluetooth Low Energy Profile Developer's Guide](#).

Create own profile as a sensor service and use it as a Master (sensor profile is defined as a client) and slave (sensor profile is defined as a server).

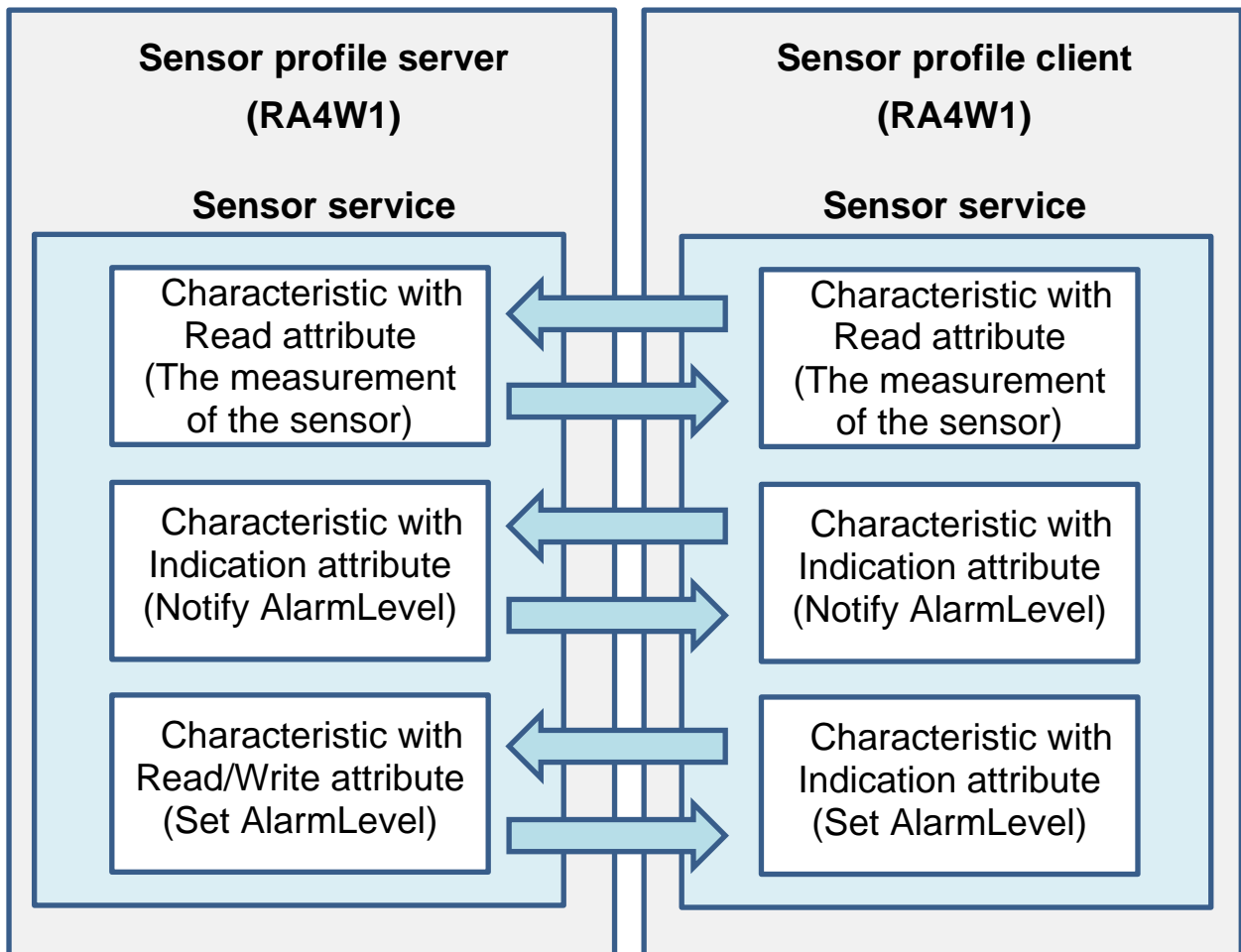

Figure 4-3 Unique profile

(2) Sensor data in BLE profile

The sensor data in the BLE profile is shown in Table 4-3.

Table 4-3 Overall BLE profile settings

Item	Contents		Type	Byte	Value	Remarks
Overall	All sensor values Reading	TVOC	uint8_t	6	00.00	String
		IAQ	uint8_t	6	00.00	String
		TEMP	uint8_t	8	±100.00	String
		RH	uint8_t	7	100.00	String
	All sensor RAW values	ZMOD4410	uint8_t	32	Sensor value	Numeric
		HS3001	uint8_t	2	Sensor value	Numeric
ZMOD4410	Alarm level setting	LEVEL	uint8_t	4	01~05	String
	Alert notification (Notify)	LEVEL	uint8_t	4	01~05	String
		TVOC	uint8_t	6	00.00	String
		IAQ	uint8_t	6	00.00	String

(3) Basic sequence in BLE profile

The basic sequence in the BLE profile is shown in Figure 4-4.

The basic sequence is roughly divided into two types:

- BLE communication
- Sensor value acquisition

In the GUI operation mode, BLE communication issues a command request (denoted as CommandReq in Figure 4-4 BLE profile sequence) from GUI Tool to the RA4W1 Master. RA4W1 Master acquires the sensor value from RA4W1 Slave via BLE. RA4W1 Slave periodically acquires values from the sensors (HS3001, ZMOD4410). RA4W1 Slave returns the already acquired sensor value as a response to Master via BLE.

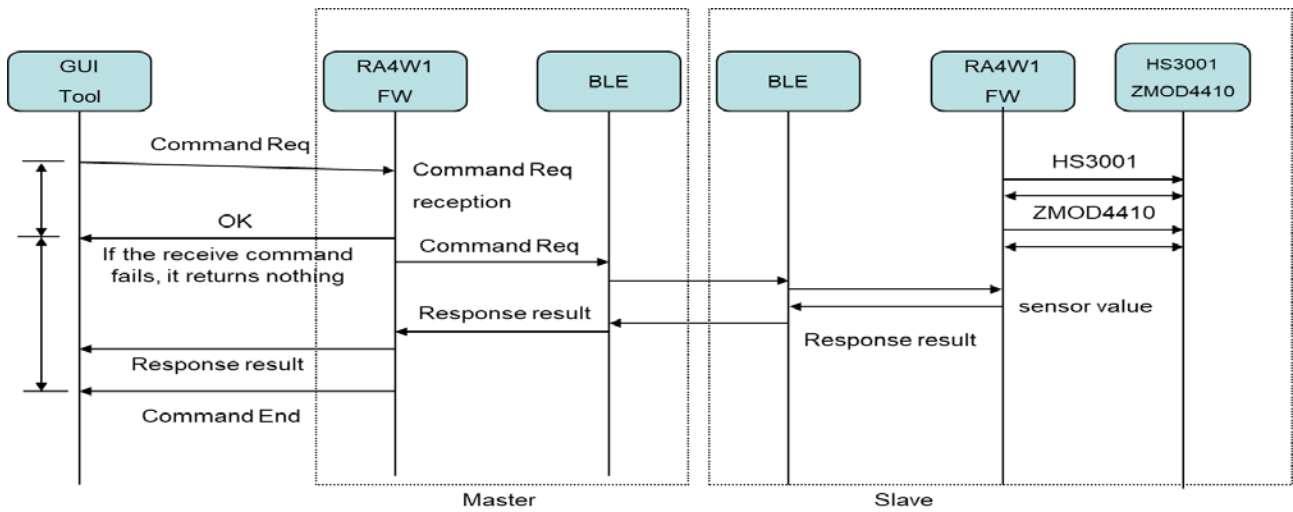

Figure 4-4 BLE profile sequence

4.5.1 Master profile

The master profile is described in Table 4-4.

Subsequent profiles are automatically generated from the R_BLE custom profile.

Table 4-4 Profile settings for master

Service	
Role	Client
Name	Renesas Sensor Service
UUID	53340fde-105c-4421-8686-eb3e04986256
Abbreviation	RSENS
Description	Renesas Sensor Service
AUX Properties	Encryption
Include	None
Error Codes	None

4.5.2 Slave profile

The slave profile is described in Table 4-5.

Table 4-5 Profile settings for slave

Service	
Role	Server
Name	Renesas Sensor Service
UUID	53340fde-105c-4421-8686-eb3e04986256
Abbreviation	RSENS
Description	Renesas Sensor Service
AUX Properties	Encryption
Include	None
Error Codes	None

- ZMOD4410 Sensor Characteristic Notify
When the Alarm Level of the ZMOD4410 Sensor or higher is reached, the converted value is notified as ASCII characters.

Table 4-8 ZMOD4410 Sensor Characteristic Notify

Characteristic		
Name	ZMOD4410 Sensor Characteristic Notify	
UUID	ec857c1a-4727-473b-ad84-d98a1fc86a6c	
Abbreviation	ZMOD4410_notify	
Description	ZMOD4410_notify	
Properties	Indicate	
AUX Properties	Peer Specific	
DB Size	16	
Value	0x00, 0x00, 0x00, 0x00, 0x00, 0x00, 0x00, 0x00, 0x00, 0x00, 0x00, 0x00, 0x00, 0x00, 0x00, 0x00,	
Field		
Name	Format/Value	Length
TVOC	uint8_t	6
IAQ	uint8_t	6
Alarm level	uint8_t	4

- ZMOD4410 Sensor Characteristic Alarm Level
Sets and reads the alarm level.

Table 4-9 ZMOD4410 Sensor Characteristic Alarm Level

Characteristic		
Name	ZMOD4410 Sensor Characteristic Alarm Level	
UUID	063a5e8a-0e51-40b5-8aa3-b996fba41516	
Abbreviation	ZMOD4410_alarm_level	
Description	ZMOD4410_alarm_level	
Properties	Read, Write	
AUX Properties	Peer Specific	
DB Size	4	
Value	0x00,0x00, 0x00, 0x00	
Field		
Name	Format/Value	Length
Alarm level	uint8_t	4

4.5.4 Pairing Settings

You can specify that the data access of the sensor profile cannot be accessed without pairing.

In the demo project, the pairing setting is off.

If you want to set the pairing specifications when accessing the data of the sensor profile, change the following part of the project file on the server side and build.

Target file: gatt_db.c

```
static const st_ble_gatts_db_serv_cfg_t gs_gatt_service[] =
{
    /* GAP Service */
    /* Renesas Sensor Service */
    {
        /* Num of Services */
        {
            1
        },
        /* Description */
        0
    }
}
```

4.6 Sensor

This section describes the process of acquiring data from the sensor.

4.6.1 ZMOD4410 (IAQ)

- (1) Acquire the sensor value of ZMOD4410 from RA4W1 to I2C.
- (2) The library function for ZMOD4410 uses the IAQ 2nd Gen: The embedded artificial intelligence (AI) algorithm ("iaq_2nd_gen").

4.6.2 How to get the ZMOD4410 library

Please download the library for ZMOD4410 from the following page.

<https://www.idt.com/document/swr/zmod4410-2nd-gen-air-quality-eco2-firmware-recommended-new-designs?language=en>

Please copy the target file from the following downloaded folder.

ZMOD4410_Firmware\gas-algorithm-libraries\iaq_2nd_gen\Arm Cortex-M\M4f\arm-none-eabi-gcc\
ZMOD4410_Firmware\zmod4xxx_example\src

Please copy the following files to the Lib_ZMOD44 folder of the project files.

lib_iaq_2nd_gen.a
lib_zmod4xxx_cleaning.a
iaq_2nd_gen.h
zmod4410_config_iaq2.h
zmod4xxx.c
zmod4xxx.h
zmod4xxx_cleaning.h
zmod4xxx_types.h

4.6.3 HS3001 (Humidity &Temp. Sensor)

Acquire the sensor value of HS3001 (Humidity &Temp. Sensor) from RA4W1 to I2C.

From the HS3001, 4 bytes of data is returned in the following order.

Humidity (Humidity Data [13: 8]), Humidity (Humidity Data [7: 0]), Temperature (Temp Data [15: 8]),
Temperature (Temp Data [7: 2]) The acquired data is calculated by the following formula.

$$\text{Humidity} [\%RH] = \left(\frac{\text{Humidity} [13 : 0]}{2^{14} - 1} \right) * 100$$

$$\text{Temperature} [^{\circ}C] = \left(\frac{\text{Temperature} [15 : 2]}{2^{14} - 1} \right) * 165 - 40$$

Figure 4-5 HS3001 (Humidity &Temp. Sensor)

4.6.4 Sensor API function specifications

The specifications of the sensor API function are shown below.

4.6.4.1 R_HS3000_Init

Feature	Initialize HS3001		
Declaration	MD_STATUS R_HS3000_Init(void)		
Argument	-	-	-
Return value	MD_OK MD_ERROR MD_ARGERROR	Normal termination Abnormal termination Argument error	
Description	Initializes and returns MD_OK.		
Notes	-		

4.6.4.2 R_HS3000_RequestMeasurement

Feature	Request measurement of HS3001		
Declaration	MD_STATUS R_HS3000_RequestMeasurement(void)		
Argument	-	-	-
Return value	MD_OK MD_ERROR MD_ARGERROR MD_BUSY2	Normal termination Abnormal termination Argument error Processing	
Description	Start measurement.		
Notes	Repeat until the return value is other than MD_BUSY2. After the return value is MD_OK, repeat R_SH3000_GetReady () until MD_OK.		

4.6.4.3 R_HS3000_GetReady

Feature	Get ready for HS3001 measurement to end		
Declaration	MD_STATUS R_HS3000_GetReady(void)		
Argument	-	-	-
Return value	MD_OK MD_ERROR MD_ARGERROR MD_BUSY2	Normal termination Abnormal termination Argument error Processing	
Description	When the timer started by R_HS3000_RequestMeasurement () expires, MD_OK is returned.		
Notes	Repeat until the return value is other than MD_BUSY1. You can get the data in R_HS3000_GetData () after the return value is MD_OK.		

4.6.4.4 R_HS3000_GetData

Feature	Start measurement of HS3001		
Declaration	MD_STATUS R_HS3000_GetData(float *temp, float *humi)		
Argument	float * float *	temp humi	Temperature data storage address Humidity data storage address
Return value	MD_OK MD_ERROR MD_ARGERROR MD_BUSY2		Normal termination Abnormal termination Argument error Processing
Description	Get the data. From the acquired data, calculate the humidity & temperature using the formula and store it at the specified address.		
Notes	Repeat until the return value is other than MD_BUSY2. When the return value is MD_OK, the sensor data is stored at the address specified by the argument.		

4.6.4.5 R_ZMOD4410_Init

Feature	Initialize ZMOD4410		
Declaration	MD_STATUS R_ZMOD4410_Init(void)		
Argument	-	-	-
Return value	MD_OK MD_ERROR MD_ARGERROR MD_BUSY2		Normal termination Abnormal termination Argument error Processing
Description	Initializes and returns MD_OK.		
Notes	-		

4.6.4.6 R_ZMOD4410_GetData

Feature	Get the data of ZMOD4410		
Declaration	MD_STATUS R_ZMOD4410_GetData(float *p_tvoc, float p_iaq)		
Argument	float * float *	p_tvoc p_iaq	TVOC data storage address IAR data storage address
Return value	MD_OK MD_ERROR MD_ARGERROR MD_BUSY2		Normal termination Abnormal termination Argument error Processing
Description	The result of acquiring data and performing library processing is stored in the specified address.		
Notes	Repeat until the return value is other than MD_BUSY2. When the return value is MD_OK, the sensor data is stored at the address specified by the argument.		

5. Build the environment

This section describes how to install the software and how to connect the board used in this demo project.

5.1 Board device connection example

The board device has three connections: USB power supply, AC adapter power supply, and lithium-ion battery power supply.

5.1.1 How to connect when the USB power supply

Connect the sensor board and power supply board to EK-RA4W1 using the USB power supply connection shown in Figure 5-1.

(Please the JP of the power board Check the connection in the form of a dotted line view)

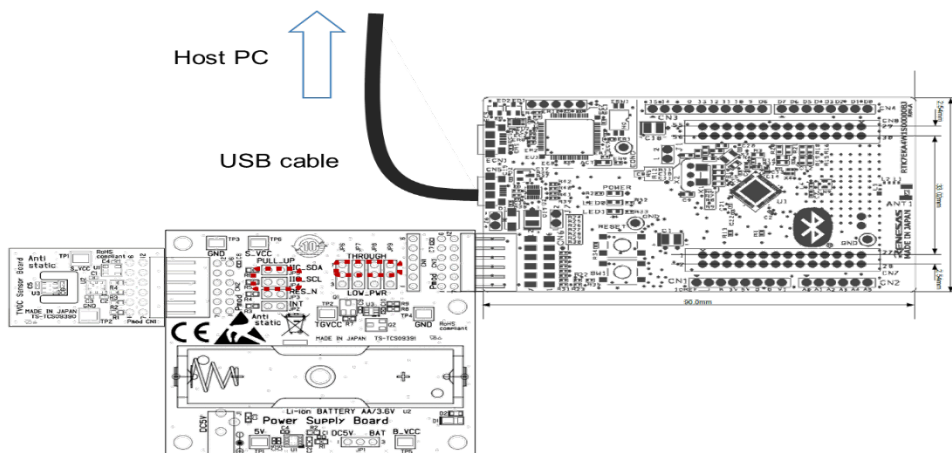

Figure 5-1 Connection environment with USB power supply

5.1.2 How to connect when the AC adapter power supply

For AC adapter power supply, **it is necessary to pattern cut SS19 on the EK RA4 W1 board.**

For details, refer to the header chapter for external power supply in the [EK-RA4W1 User's Manual](#).

An AC adapter is required to make this connection. For details, refer to the manuals for the sensor board and power supply board.

Connect the sensor board and power supply board to EK-RA4W1 using the AC adapter power supply connection shown in Figure 5-2.

(Please the JP of the power board Check the connection in the form of a dotted line view)

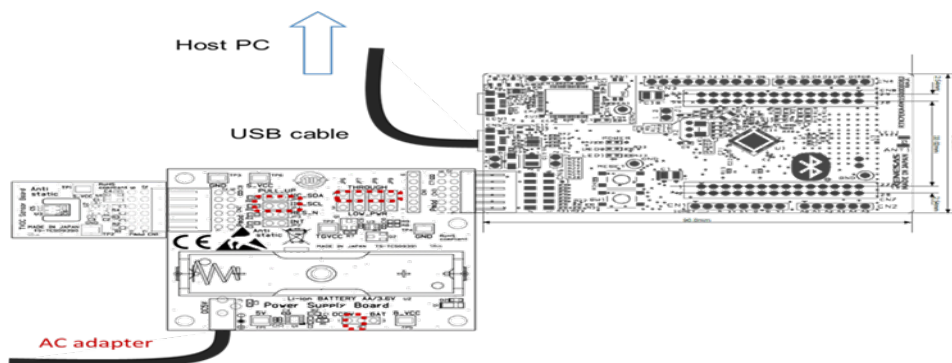

Figure 5-2 Connection environment with AC adapter power supply

5.1.3 How to connect when the lithium-ion battery power supply

For lithium-ion battery power supply, [it is necessary to pattern cut SS19 on the EK RA4 W1 board.](#)

For details, refer to the header chapter for external power supply in the [EK-RA4W1 User's Manual.](#)

An lithium-ion battery is required to make this connection. For details, refer to the manuals for the sensor board and power supply board.

Connect the sensor board and power supply board to EK-RA4W1 using the lithium-ion battery power supply connection shown in Figure 5-3.

(It is necessary to set JP of the power supply board to "BAT" in the form of a dotted line diagram.)

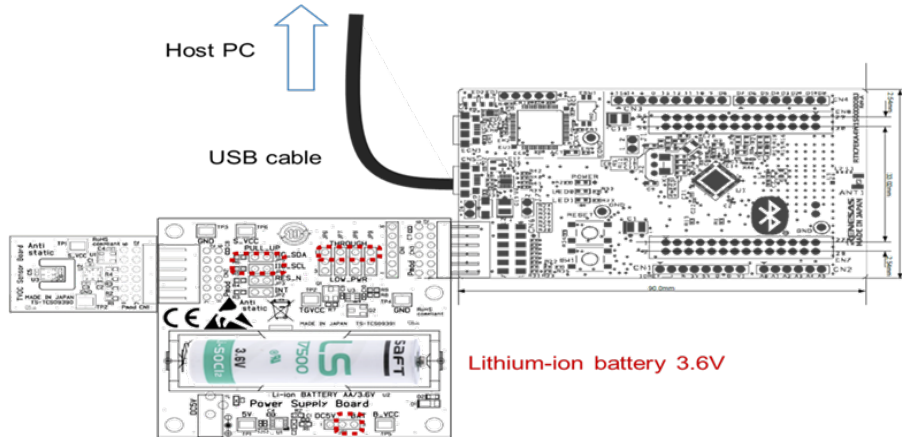

Figure 5-3 Connection environment with lithium-ion battery power supply

5.1.4 How to connect when connecting to the GUI.

Build the environment by the method shown below.

- Connect the sensor board and power supply board to EK-RA4W1 with the connection shown in Figure 5-4.
- Connect EK-RA4W1 and PC by the method of “2. Kit Connection” in [EK-RA4W1 – Quick Start Guide](#).

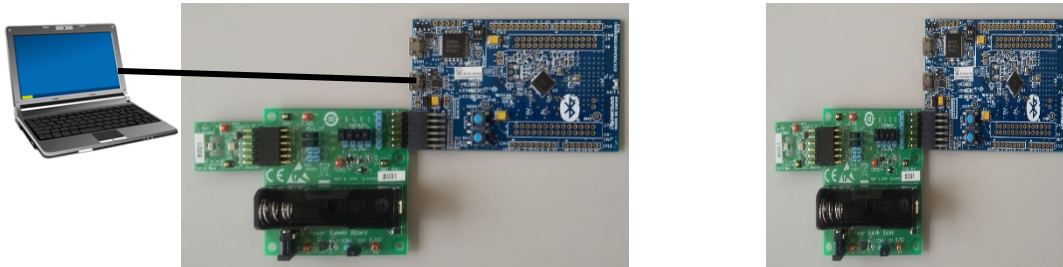

Figure 5-4 Connection environment with GUI

5.1.5 RA4W1 independent operation

Connect the sensor board and power supply board to EK-RA4W1 by the method shown in Figure 5-5.

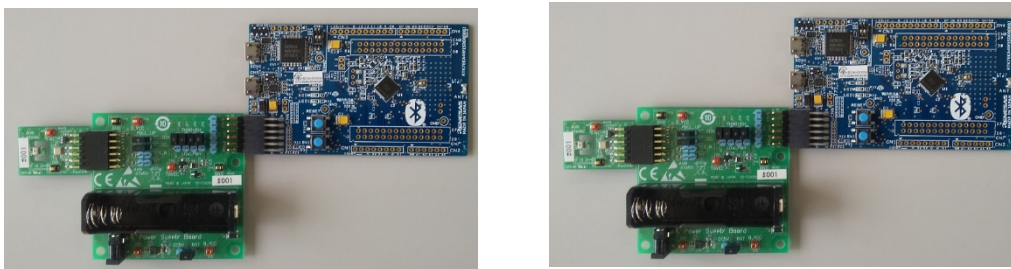

Figure 5-5 RA4W1 independent connection environment

5.1.6 Network construction

- Place the Master and Slave and place them in a short distance found by SCAN.

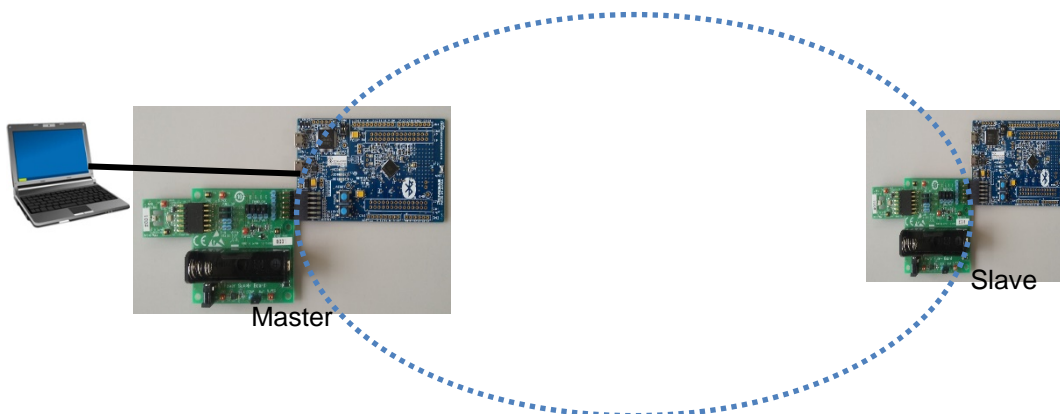

Figure 5-6 Network construction

NOTE: If you change the network configuration (such as exchanging Slave) between Master and Slave, please press SW1 and RESET SW on the EK-RA4W1 board to clear the KEY information of the data flash of RA4W1.

5.2 Development environment

The development environment is described below.

Table 5-1 Development environment

Development environment		Ver
Integrated environment	e ² studio	2020-10
Compiler	GCC ARM Embedded	9.2.1. 2019.10.25
Driver	Renesas Flexible Software Package (FSP)	2.2.1
BLE control	BLE Protocol Stack BLE Protocol Stack (ALL Features)	-
Profile	QE for BLE [RA]	1.1.0
Sensor library (ZMOD4410)	REN_ZMOD4410-AirQuality-eCO2-FW-2nd-Gen- 2p1p2_SWR_20201019.zip gas-algorithm-libraries Arm Cortex-M M4 arm-none-eabi- gcc	SWR 20201019

5.2.1 How to install e2 studio

Refer to "[Renesas e2 studio 2020-10](#)" document from the Renesas Electronics website.

5.2.2 How to install FSP

Refer to "[flexible-software-package-fsp](#)" document from the Renesas Electronics website.

5.2.3 How to import the e2studio project

Refer to "[BLE sample application](#)" document from the Renesas Electronics website.

5.2.4 GUI related installation

Copy the file "R11AN0488JJ0100_RA4W1_SampleProject.zip" and self-extract it.
Copy the "SensorNetworkSolutionGUI" folder in the unzipped file to a folder on your PC.

5.3 Run the demo project

Refer to "r01an5402ej0101-ra4w1-ble-sample-application.pdf" from the Renesas Electronics website.

5.4 Writing the Demo Project

Refer to "[EK-RA4W1 – Quick Start Guide\(R20QS0015\)](#)" for the writing tool and method.

Set the writing tool settings as shown in Figure 5-7. Select the SREC file used for writing from the demo project.



Figure 5-7 Writing the Demo Project

5.5 Operation when connecting to GUI

The operation when connecting the GUI is described in this chapter.

5.5.1 Screen description

5.5.1.1 Startup screen

Figure 5-8 is displayed when this application is started.

On this screen, select the GUI operation mode. The screen transition is performed according to the operation mode selected by the screen.

Table 5-2 shows the functional details of each area.

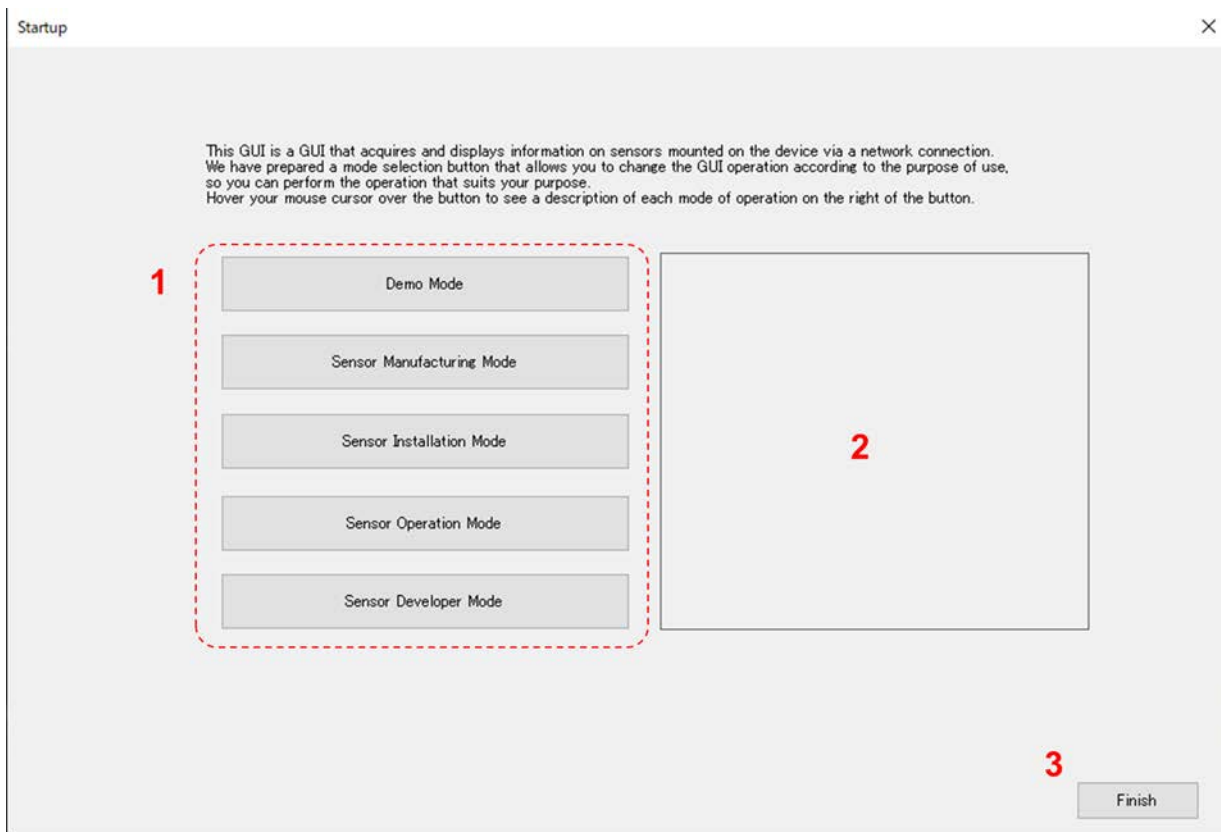

Figure 5-8 Startup screen

Table 5-2 Startup screen Feature list

No.	Name	Description
1	"Each operation mode button" area	When you press each button, the following screens according to the operation mode are displayed. <ul style="list-style-type: none"> • Demo Mode: Display the demo address rewriting screen • Sensor Manufacturing Mode: Display address rewriting screen • Sensor Installation Mode: Display BLE connection screen • Sensor Operation Mode: Display the operation sensor information display screen • Sensor Developer Mode: Display BLE connection screen
2	"Explanation of each operation mode" area	When you move the mouse cursor over the button, the description according to the operation mode is displayed. If you remove the mouse cursor from the button, the description will not be displayed.
3	"Finish" button	Click the button to exit the GUI.

5.5.1.2 Address setting screen

On Figure 5-9 screen, the device connected via USB is connected to the COM port and the MAC address or device address is rewritten.

Table 5 3 shows the functional details of each area.

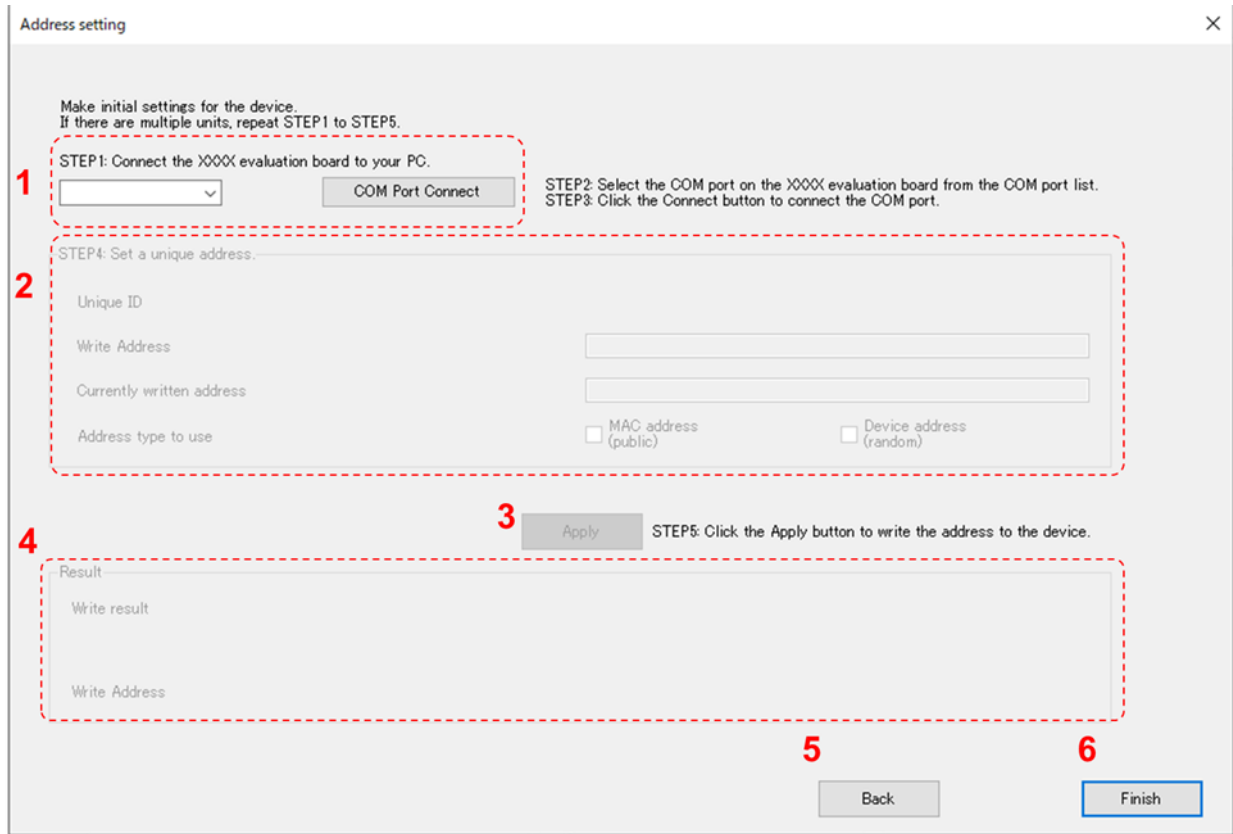

Figure 5-9 Address setting screen

Table 5 3 Address setting screen feature list

No.	Name	Description		
1	"COM port connection / disconnection" area	<p>The drop-down list shows the names of currently connectable COM ports.</p> <p>The displayed COM port name recognizes RA4W1. Other COM port names are not displayed.</p> <p>Select the COM port name to connect to and press the "COM Port Connect" button to make a COM port connection.</p> <p>As soon as the COM port is connected, the "COM Port Connect" button switches to the "COM Port Disconnect" button.</p>		
2	"Address rewriting content display" area	<p>After connecting to the COM port, the address currently written to the device is automatically acquired.</p> <p>After the acquisition is completed, the area will be activated and the address will be displayed.</p>		
		<table border="1"> <tr> <td>Unique ID</td> <td>A unique ID written on the device.</td> </tr> </table>	Unique ID	A unique ID written on the device.
		Unique ID	A unique ID written on the device.	
		<table border="1"> <tr> <td>Write Address</td> <td>The address to write to the device. If you want to write a address different from a address displayed here, rewrite the area.</td> </tr> </table>	Write Address	The address to write to the device. If you want to write a address different from a address displayed here, rewrite the area.
Write Address	The address to write to the device. If you want to write a address different from a address displayed here, rewrite the area.			
<table border="1"> <tr> <td>Currently written address</td> <td>The address written to the device.</td> </tr> </table>	Currently written address	The address written to the device.		
Currently written address	The address written to the device.			
3	"Apply" button	<table border="1"> <tr> <td>Address type to use</td> <td>The type of address currently displayed. Rewrites the address of the selected address type. The device address is selected as the default.</td> </tr> </table>	Address type to use	The type of address currently displayed. Rewrites the address of the selected address type. The device address is selected as the default.
		Address type to use	The type of address currently displayed. Rewrites the address of the selected address type. The device address is selected as the default.	
<p>Writes the address displayed in Write Address to the device with the type selected in Address type to use.</p> <p>After the writing is completed, the address is read again.</p>				
4	"Write result display" area	<p>Displays the result written to the device.</p> <p>The written address is compared with the read address again, and if they match, "Writing Completed" is displayed in "Write result".</p> <p>At the same time, the read address is displayed again.</p> <p>If the comparison results are different, "Write failure" is displayed.</p>		
5	"Back" button	Click the button to return to the previously displayed screen.		
6	"Finish" button	Click the button to exit the GUI.		

5.5.1.3 BLE connection screen

Figure 5-10 is the screen to connect BLE using the connected device.
 Table 5-4 shows the functional details of each area.

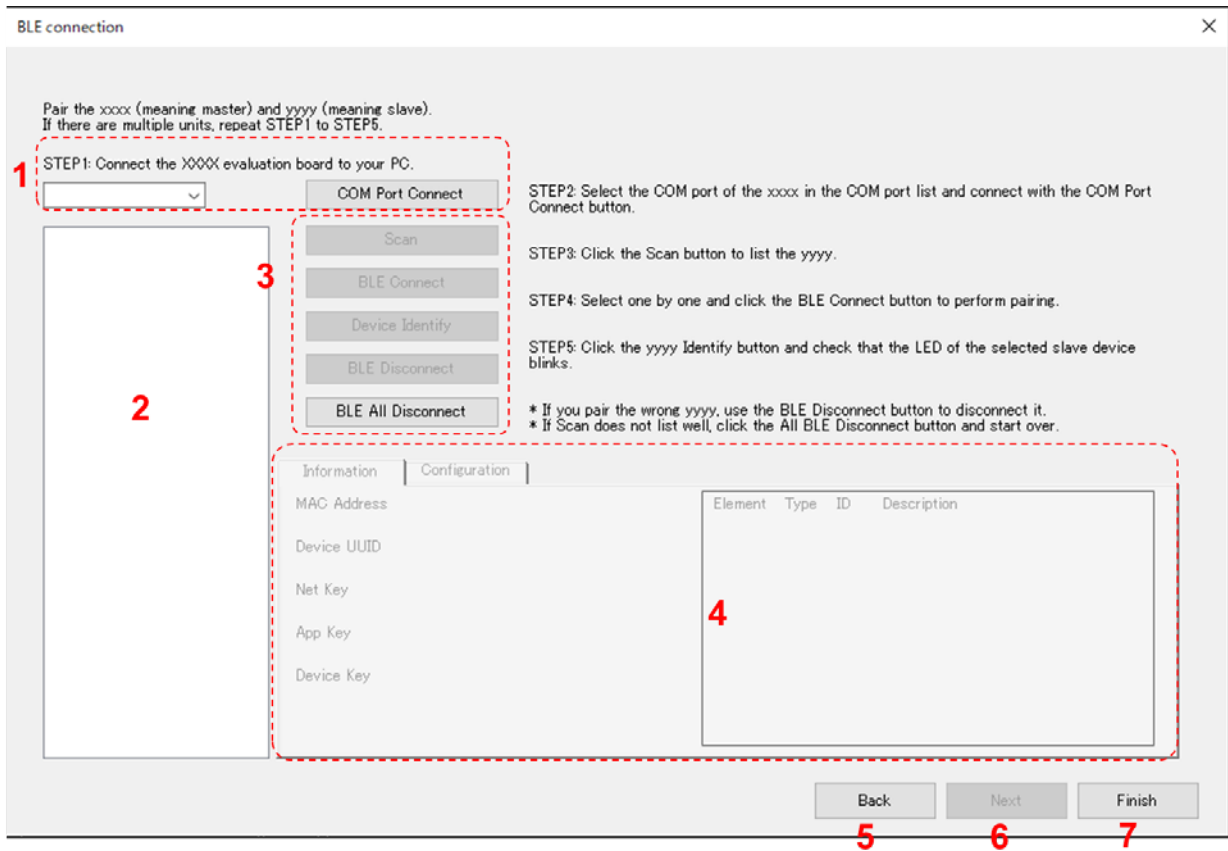

Figure 5-10 Connection screen

Table 5-4 Connection screen Feature list

No.	Name	Description
1	"COM port connection / disconnection" area	The drop-down list shows the names of currently connectable COM ports. The displayed COM port name recognizes RA4W1. Other COM port names are not displayed. Select the COM port name to connect to and press the "COM Port Connect" button to make a COM port connection. As soon as the COM port is connected, the "COM Port Connect" button switches to the "COM Port Disconnect" button.
2	"Device display" area	Displays device addresses that have not been connected or have saved connection settings. *a
3	"BLE connection / disconnection" button area	This is a button area for BLE connection or disconnection, and device identification instructions. <ul style="list-style-type: none"> • Scan button Click the button to send a scan request to the device and receive a connectable devices address. After receiving, the address is displayed in the "Device display" area. This button will not be activated until the COM port connection and the search for BLE connected devices are completed. • BLE Connect button Click the button to make a BLE connection with the device. Buttons can be clicked only for devices that are not connected to BLE. • Device Identify button Click the button to make LED0 on the device blink. Buttons can be clicked after connecting to BLE. • BLE Disconnect button Click the button to disconnect the BLE connection with the device. Buttons can be clicked after connecting to BLE. • BLE All Disconnect button Click the button to disconnect the BLE connection with all devices. <p>* Common to all buttons other than the Scan button and BLE All Disconnect button, if you click the button without selecting the address in the "Device display" area, an error message will be displayed.</p>
4	"Information" tab	The information of the device selected in the "Device display" area is displayed. * Not supported in this version. This function will be used in future expansion.
	"Configuration" tab	Communication type: This is the mesh operation setting tab for BLE connected devices, which is performed when Mesh. Communication type: Tab selection is possible when Mesh. * Not supported in this version. This function will be used in future expansion.
5	"Back" button	Click the button to return to the previously displayed screen.
6	"Next" button	Click the button to move to the next screen.
7	"Finish" button	Click the button to exit the GUI.

Note As the address used for the BLE connection is the device address, the device address is displayed on the device display area.

Changing the address type (MAC address / device address) used for BLE connection is not supported in this version.

When Master and Slave fail to connect to BLE, press the "BLE All Disconnect button" to clear the KEY information of Master. For Slave, press SW1 and press the RESET button.

5.5.1.4 Select contents screen

In Figure 5-11, select the floor image and device image to use for the sensor information display screen.

Table 5-5 shows the functional details of each area.

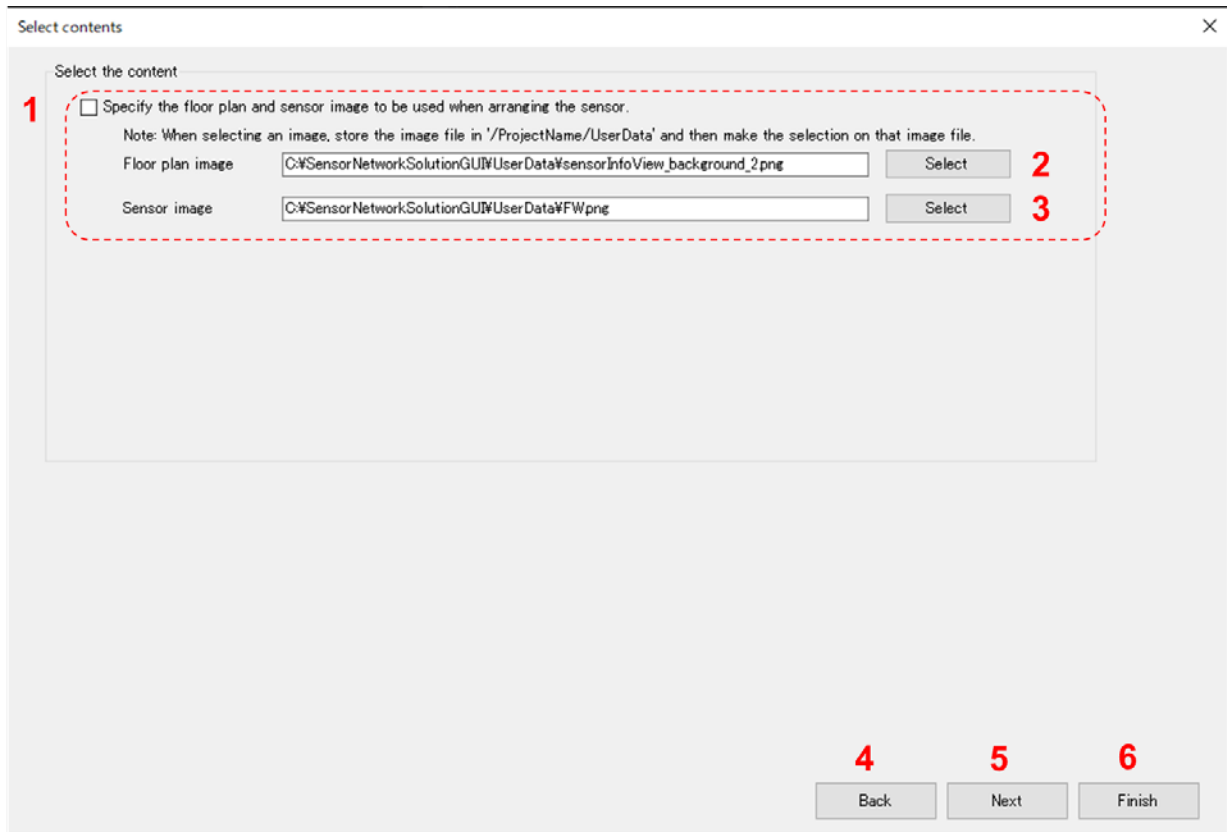

Figure 5-11 Select contents screen

Table 5-5 Select contents screen Feature list

No.	Name	Description
1	"Image selection" area	Select the image to use on the sensor information display screen. You can change the background and device of the image. If you check the check box, the image will not be changed. The size of each image data is specified below. <ul style="list-style-type: none"> · Background image: 726 * 215 pixels · Device image: 40 * 35 pixels · Extension: png When using image data, store it below. ¥ProjectName¥UserData
2	"Floor plan image Select" button	Click the button to display the "Select Image File" dialog box. Select an image in the "Select Image File" dialog box and click the "Open" button to display the image file path in the text box.
3	"Sensor image Select" button	
4	"Back" button	Click the button to return to the previously displayed screen.
5	"Next" button	Click the button to move to the next screen.
6	"Finish" button	Click the button to exit the GUI.

5.5.1.5 GUI operation setting screen

Figure 5-12 shows the screen for setting GUI operation. Some of the settings are saved in an xml file.

Table 5-6 shows the functional details of each area.

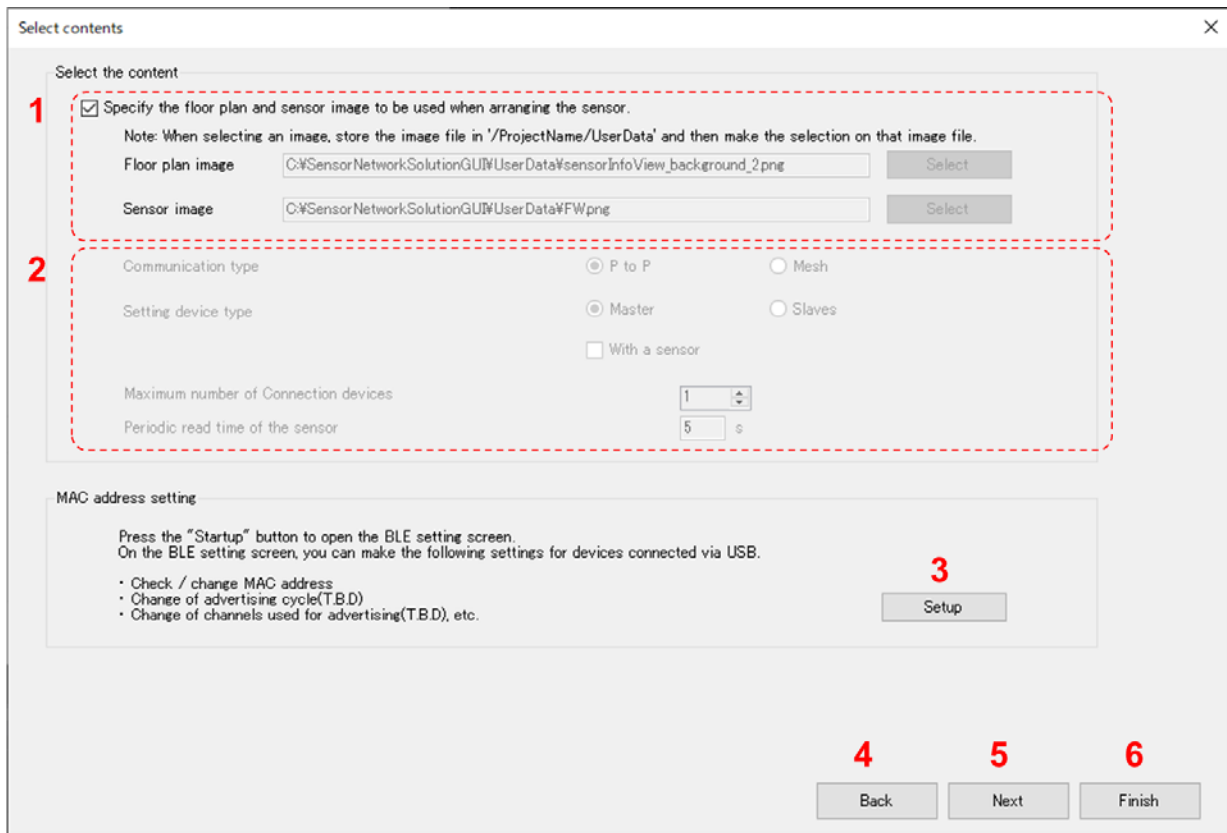

Figure 5-12 GUI operation setting screen

Table 5-6 GUI operation setting screen Feature list

No.	Name	Description
1	"Image selection" area	Select the image to use on the sensor information display screen. You can change the background and device of the image. If you check the check box, the image will not be changed. The size of each image data is specified below. <ul style="list-style-type: none"> · Background image: 726 * 215 pixels · Device image: 40 * 35 pixels · Extension: png When using image data, store it below. ¥ProjectName¥UserData
2	"GUI operation setting" area	Set the operation of this GUI. <ul style="list-style-type: none"> · Communication type: PtoP · Connected device type: Master · Maximum number of connected devices when connecting to BLE: 7 · Periodic reading cycle of sensor information performed by GUI: 10s * · For Master: With or without sensor connection: With connection
3	"Starup" button	Click the button to display the BLE setting screen.
4	"Back" button	Click the button to return to the previously displayed screen.
5	"Next" button	Click the button to move to the next screen.
6	"Finish" button	Click the button to exit the GUI.

Note The shortest cycle time for acquiring the sensor value of the terminal is 2s. Do not set less than 2s.

5.5.1.6 Sensor Information screen

Figure 5-13 shows the screen that displays the sensor information of the device connected to BLE. Table 5-7 shows the functional details of each area.

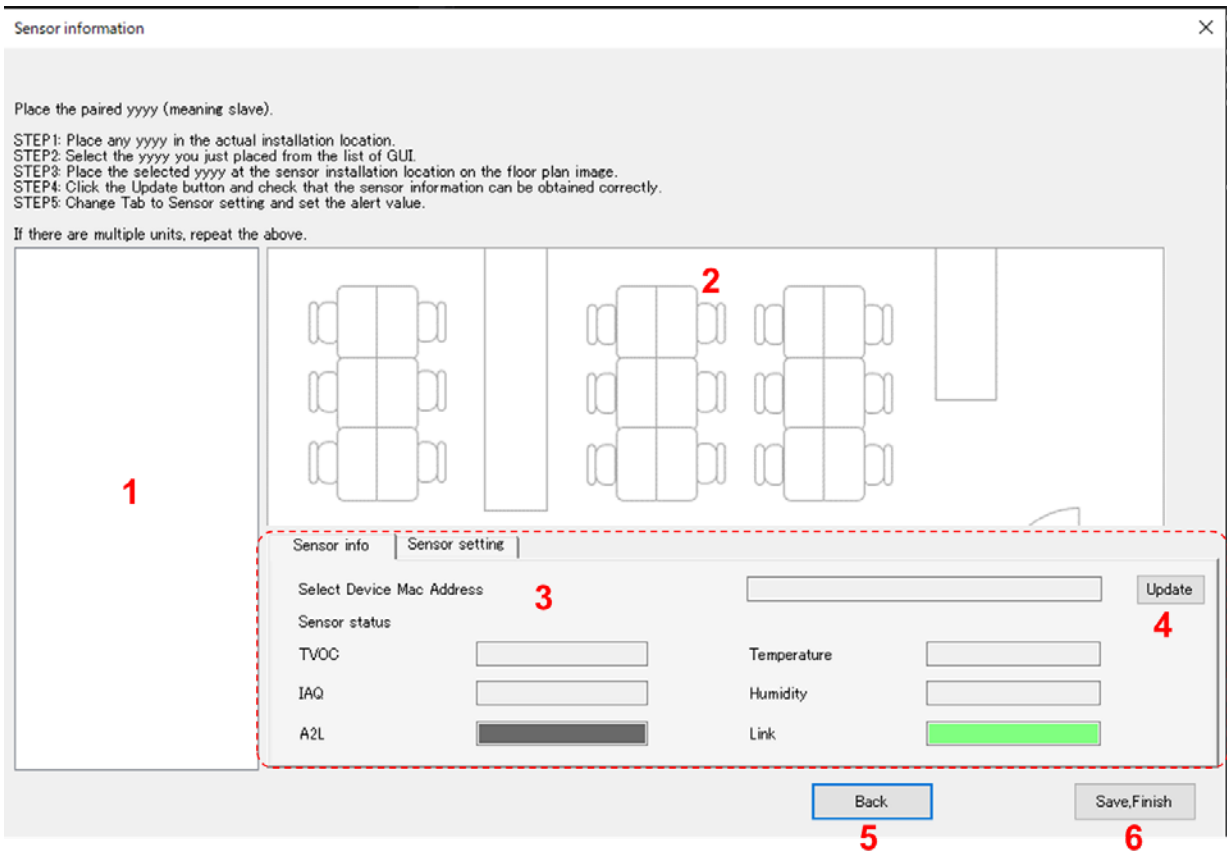

Figure 5-13 Sensor Information screen

Table 5-7 Sensor information screen Feature list

No.	Name	Description
1	"Connected device display" area	Displays the address of the device that made the BLE connection. When you select the address, the sensor information of the selected device is displayed on the "Sensor info" tab.
2	"Layout" area	This is the area where the connected devices are placed on the diagram. As shown in Figure 5-14, the image of the device is displayed for the number of connected devices, and it can be freely placed in the area. Click the placed device to display the sensor information of the selected device on the "Sensor info" tab.
3	"Sensor info" tab	Displays the sensor information of the device selected in the "Connected device display" area or the "Layout" area. The sensor information to be displayed is as follows. <ul style="list-style-type: none"> • address of device (In this version, the device address is displayed.) • TVOC level • IAQ level (• A2L: Not supported in this version.) • Temperature • Humidity • Connection status
4	"Update" button	Click the button to reacquire and display the currently displayed sensor information.
5	"Back" button	Click the button to return to the previously displayed screen.
6	"Save, Finish" button	Click the button to save the BLE connection status and device image placement position in the xml file and exit the GUI.

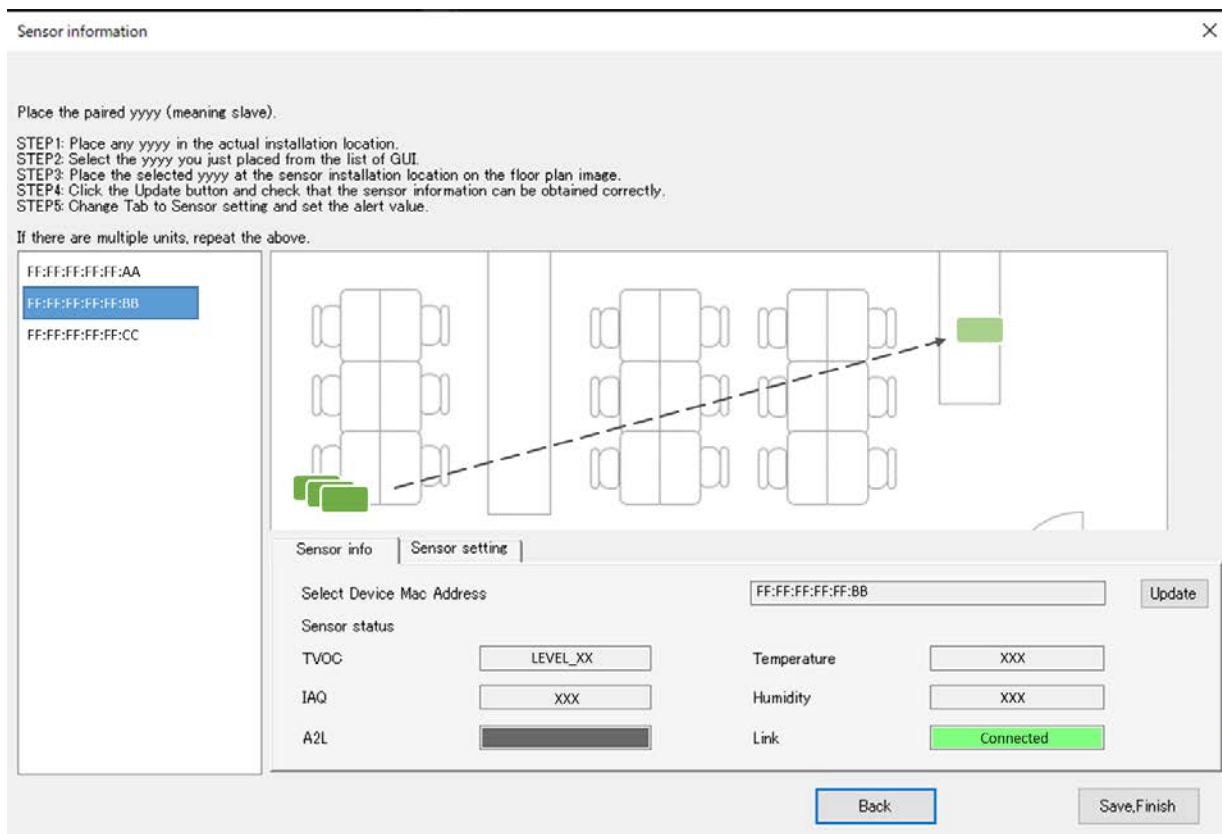

Figure 5-14 Sensor information screen "Layout" area

Table 5-8 shows the features of the sensor level setting screen in Figure 5-15.

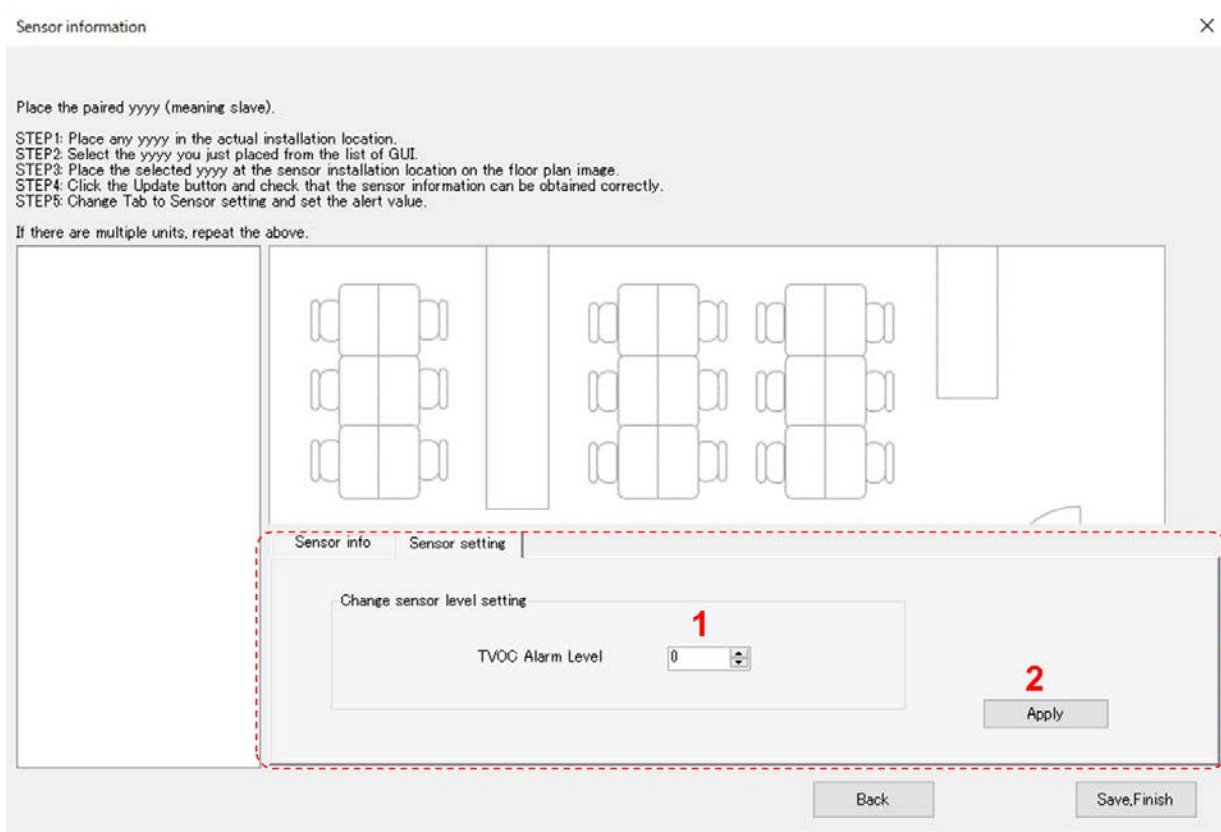

Figure 5-15 Sensor level setting screen

Table 5-8 Sensor level setting screen Feature list

No.	Name	Description
1	"Sensor setting" area	This area is for changing the level setting of the TVOC sensor. The sensor level that can be changed is 1 to 5. See page 10 of the ZMOD4410 data sheet for sensor levels. <ul style="list-style-type: none"> • https://www.renesas.com/us/en/products/sensor-products/gas-sensors/zmod4410-indoor-air-quality-sensor-platform
2	"Apply" button	Sets the settings in the "Sensor setting" area for the selected device.

5.5.2 Demo Mode

5.5.2.1 Screen transition

In demo mode, screen transitions are performed in the following order by clicking on the "Next" button, except for the boot screen.

- 1. Startup screen
- 2. Address setting screen
- 3. BLE connection screen
- 4. Sensor information screen

If you click the "Back" button, the screen will change in the reverse order.

Click the "Finish" button or "Close" button displayed on each screen to exit the GUI.

Figure 5-16 and Figure 5-17 shows the screen transitions when operating in Demo mode. In addition, the operating procedure for each screen is described in Chapter 5.5.2.2.

1

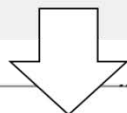
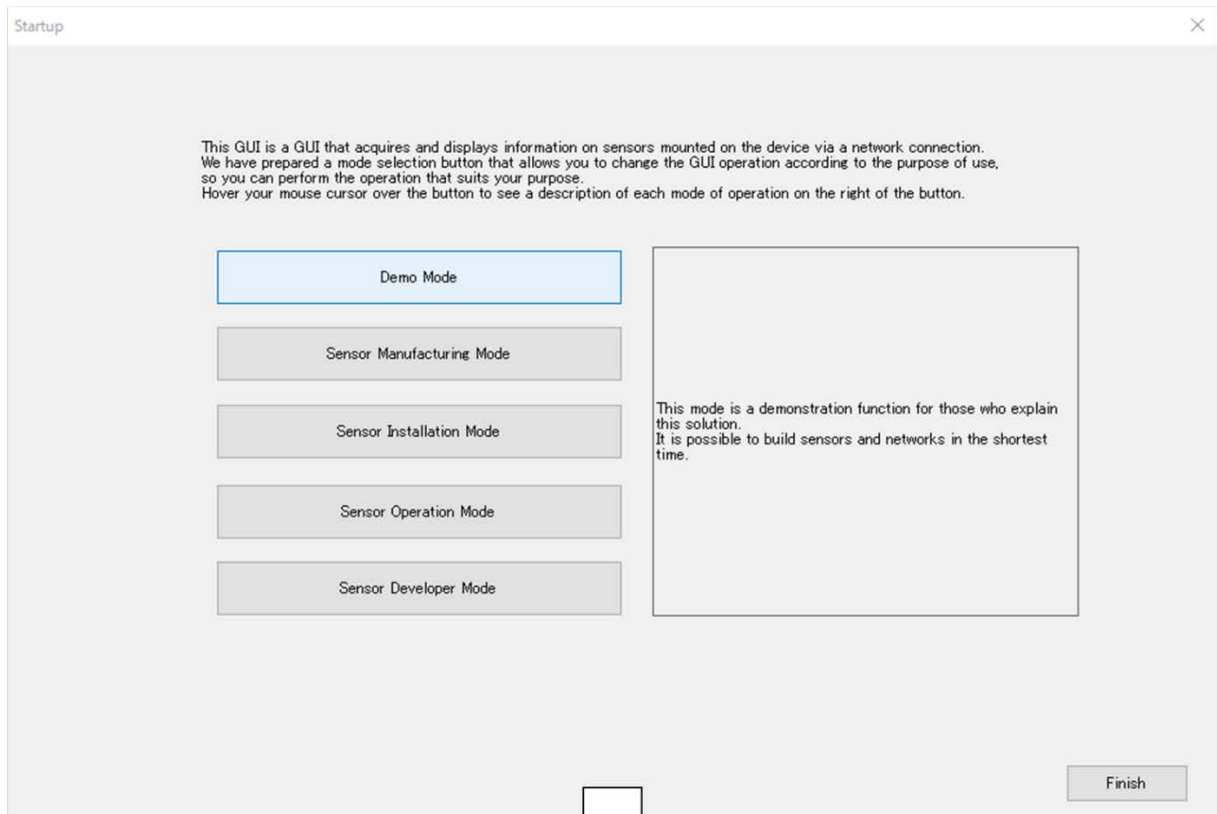

2

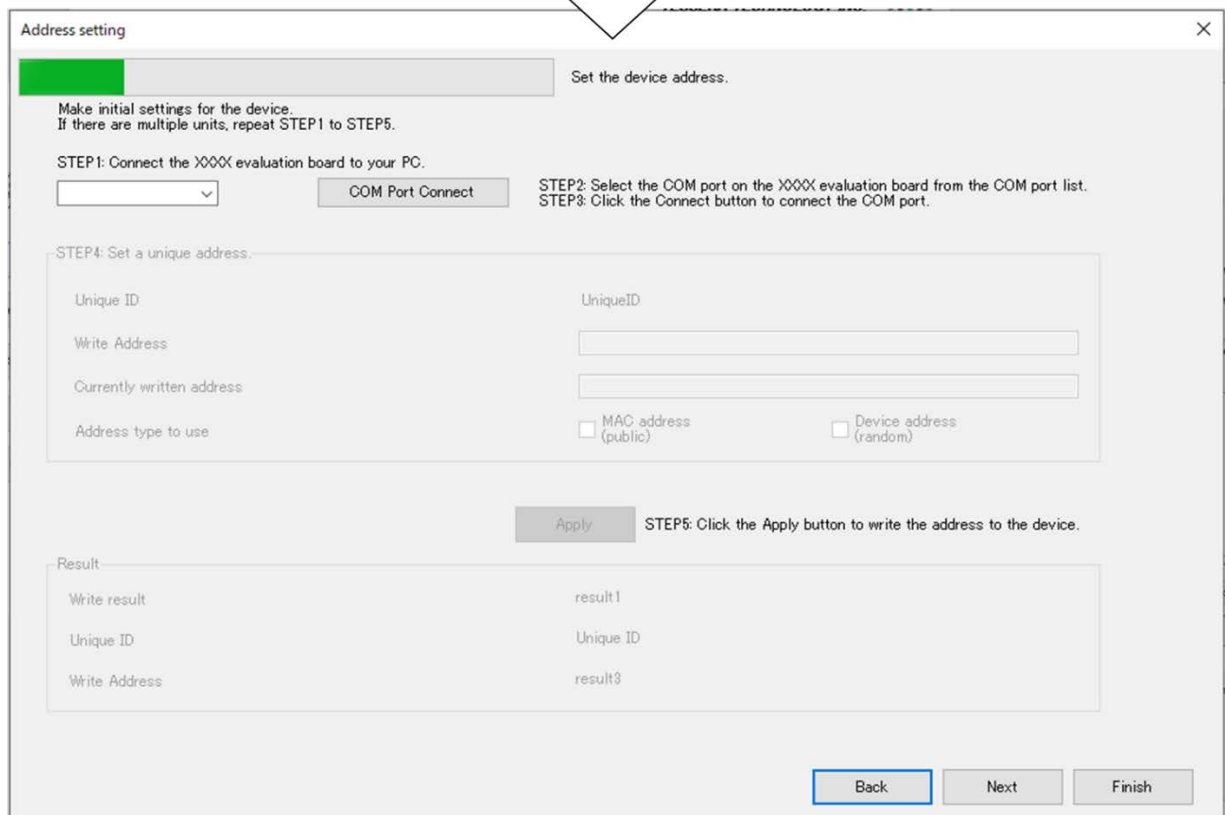

Figure 5-16 Demo Mode screen transition diagram(1/2)

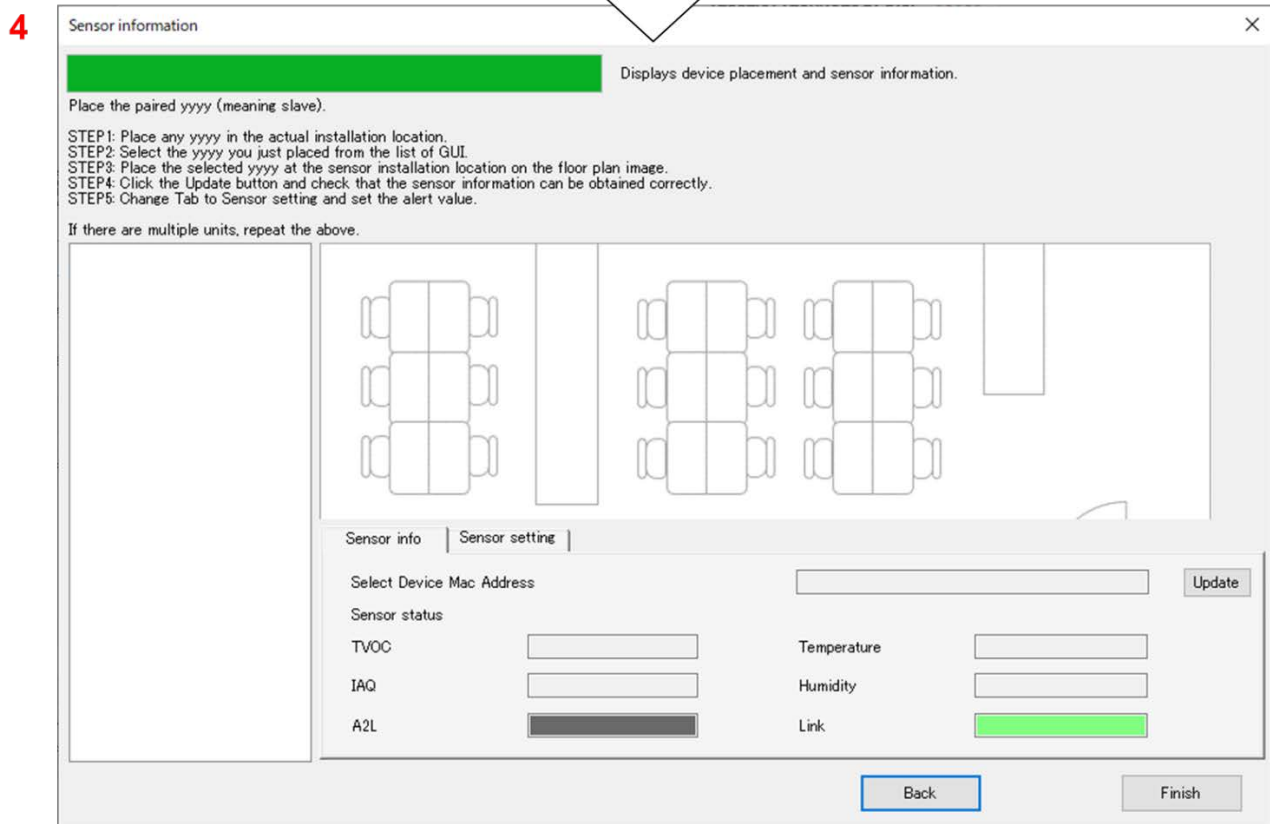
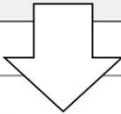
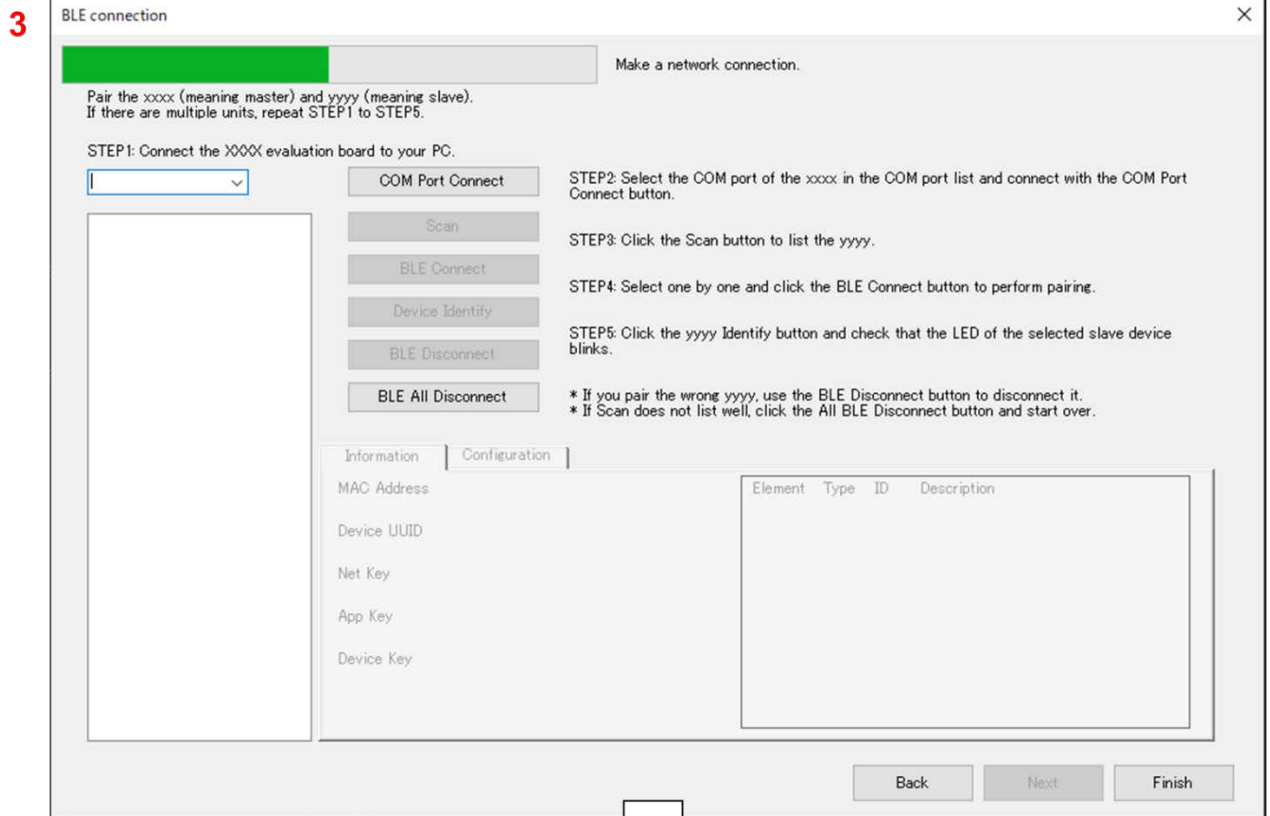

Figure 5-17 Demo Mode screen transition diagram(2/2)

5.5.2.2 Operation

The operation method when operating in the Demo Mode is described in the transition order shown in Figure 5-16 and Figure 5-17.

(1) Startup screen

(1)-1 Click the "Demo Mode" button.

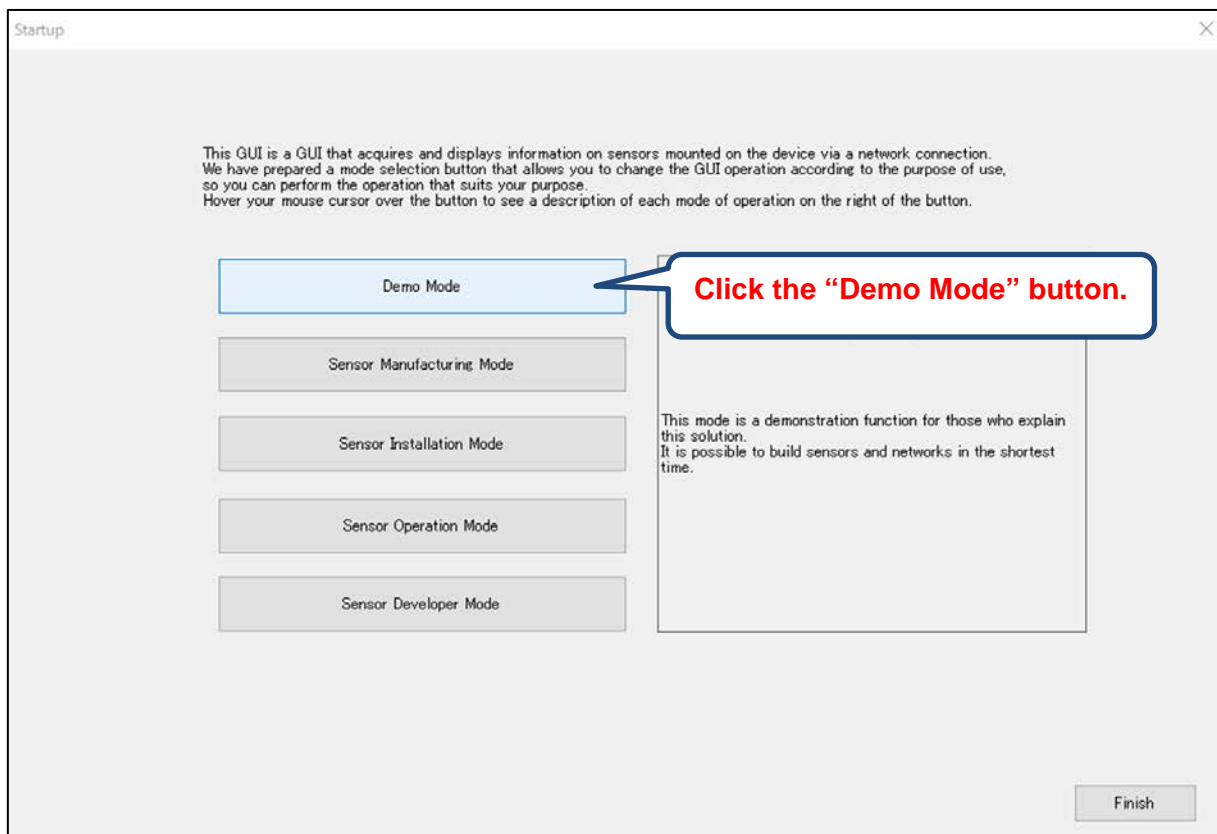

Figure 5-18 Startup screen demo mode operation

(2) Address setting screen

(2)-1 The address setting screen is displayed.

Connect the device that rewrites the address via USB.

Click the drop-down list to display the COM ports you can connect to.

Select the COM port to connect to and click the "COM Port Connect" button.

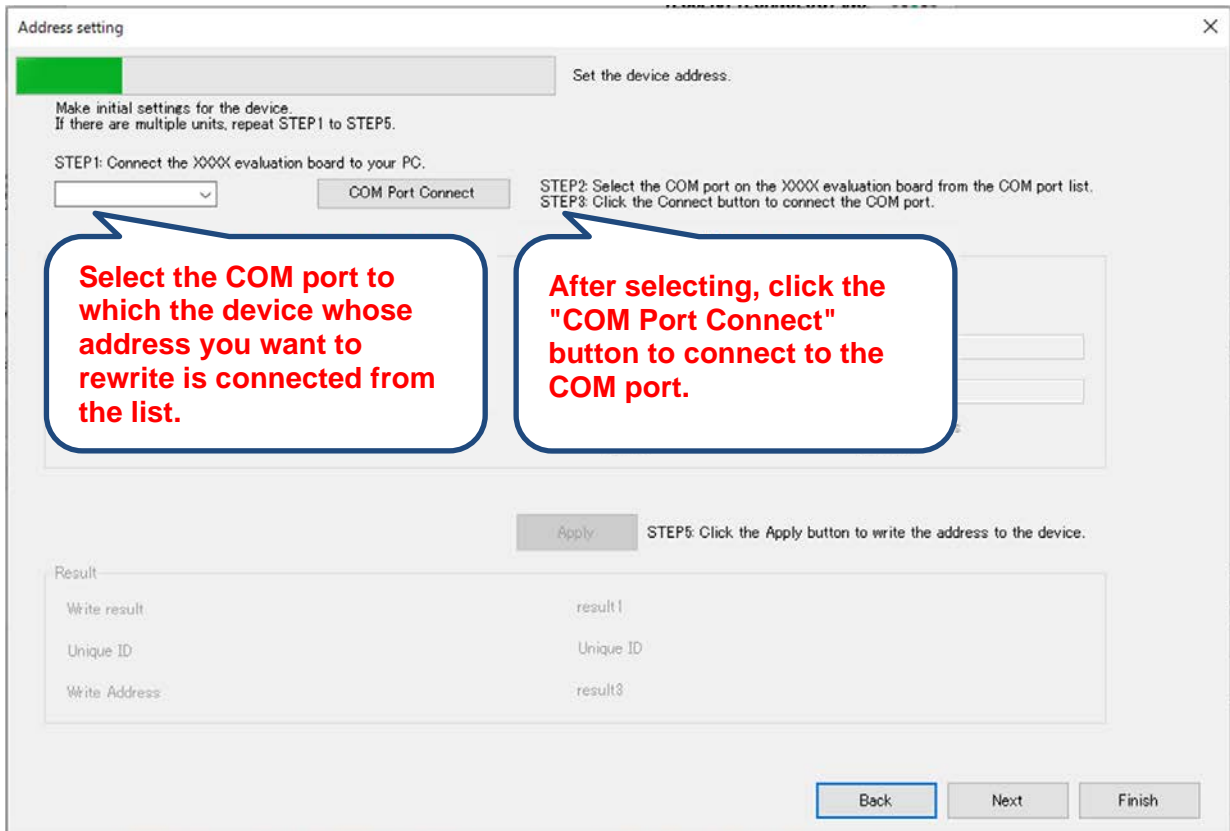

Figure 5-19 Address setting screen operation(1/3)

- (2)-2 "STEP 4: Set a unique address": This area displays the address currently written to the device. Wait until the area is displayed.
- (2)-3 When the "STEP 4: Set a unique address" area is displayed, check the following items.
- Address displayed in "Write Address": The address to write to the device.
 - Address type to use" check box: The address type to be rewritten.
- If you want to write an address that is different from the displayed content, change "Write Address" and "Address type to use" to any content.
- (2)-4 Press the "Apply" button to write.

Address setting

Set the device address.

Make initial settings for the device.
If there are multiple units, repeat STEP1 to STEP5.

STEP1: Connect the XXXX evaluation board to your PC.
COM13 COM Port Disconnect

STEP2: Select the COM port on the XXXX evaluation board from the COM port list.
STEP3: Click the Connect button to

STEP4: Set a unique address.

Unique ID ID:31072B1E3538303128FA3:72797

Write Address 28:95:DF:49:65:67

Currently written address DA:6F:3E:48:8A:0A

Address type to use MAC address (public) Device address (random)

Apply STEP5: Click the Apply button to write the address to the device.

Result

Write result

Write Address

Back Next Finish

Figure 5-20 Address setting screen operation(2/3)

- (2)-5 Wait for the "Result" area to appear.
- (2)-6 When the "Result" area is displayed, check the following.
 - "Write result": Displays the write result. If "Write complete" is displayed, the writing is successful.
- (2)-7 Click "Next" button to move to the next screen.

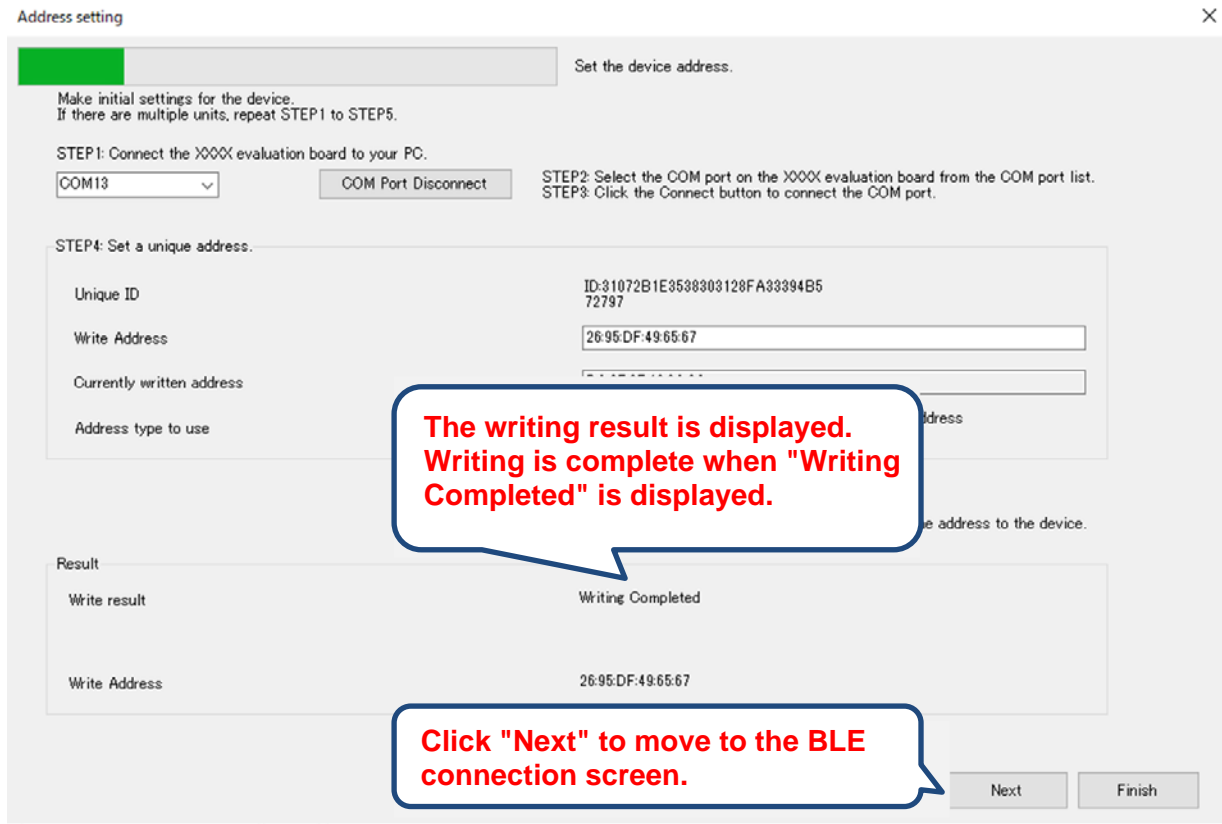

Figure 5-21 Address setting screen operation(3/3)

(3) BLE connection screen

(3)-1 Select the COM port to which the Master device is connected and click "COM Port Connect".

(3)-2 Wait for the "Scan" button to appear.

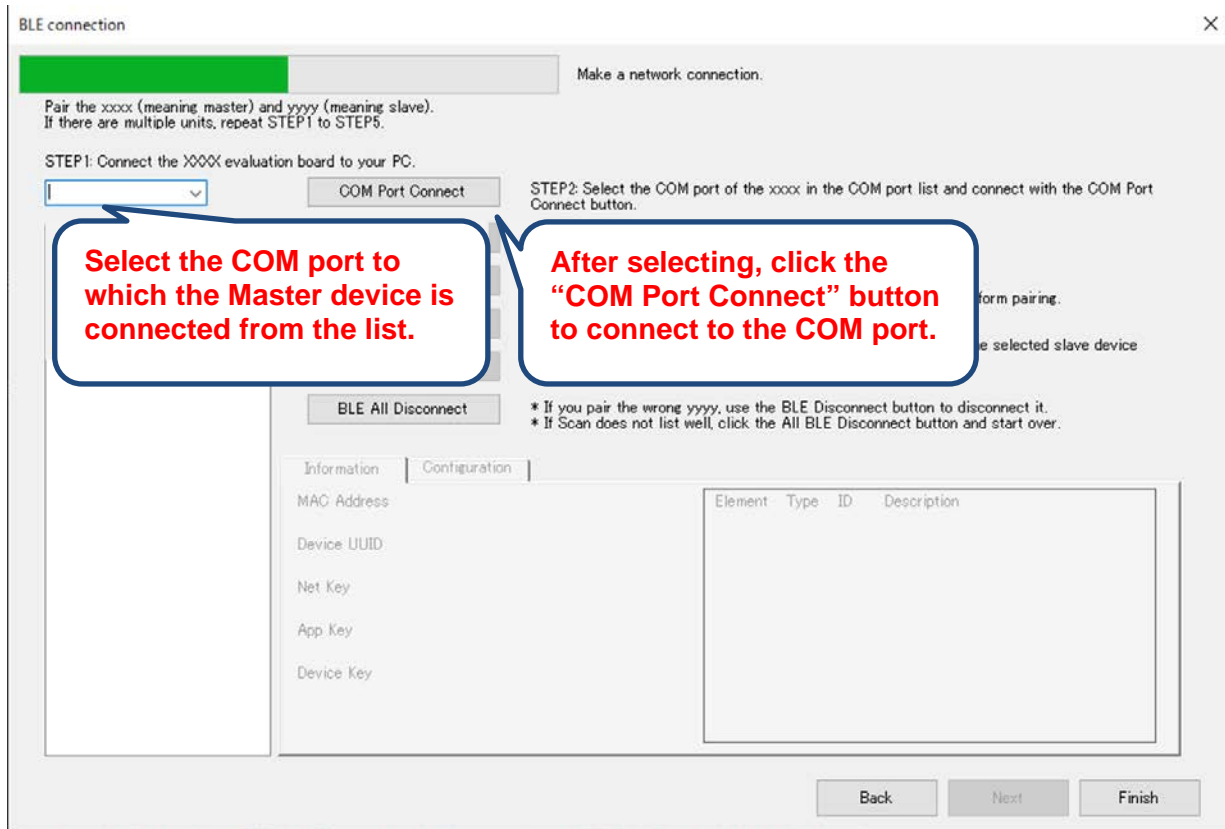

Figure 5-22 BLE connection screen operation(1/3)

- (3)-3 When the "Scan" button appears, click the "Scan" button.
Wait until the BLE connectable address is displayed.
- (3)-4 When the address is displayed, select the address and click the "BLE Connect" button.
When the connection is completed it will be pressed the "Identify" button.

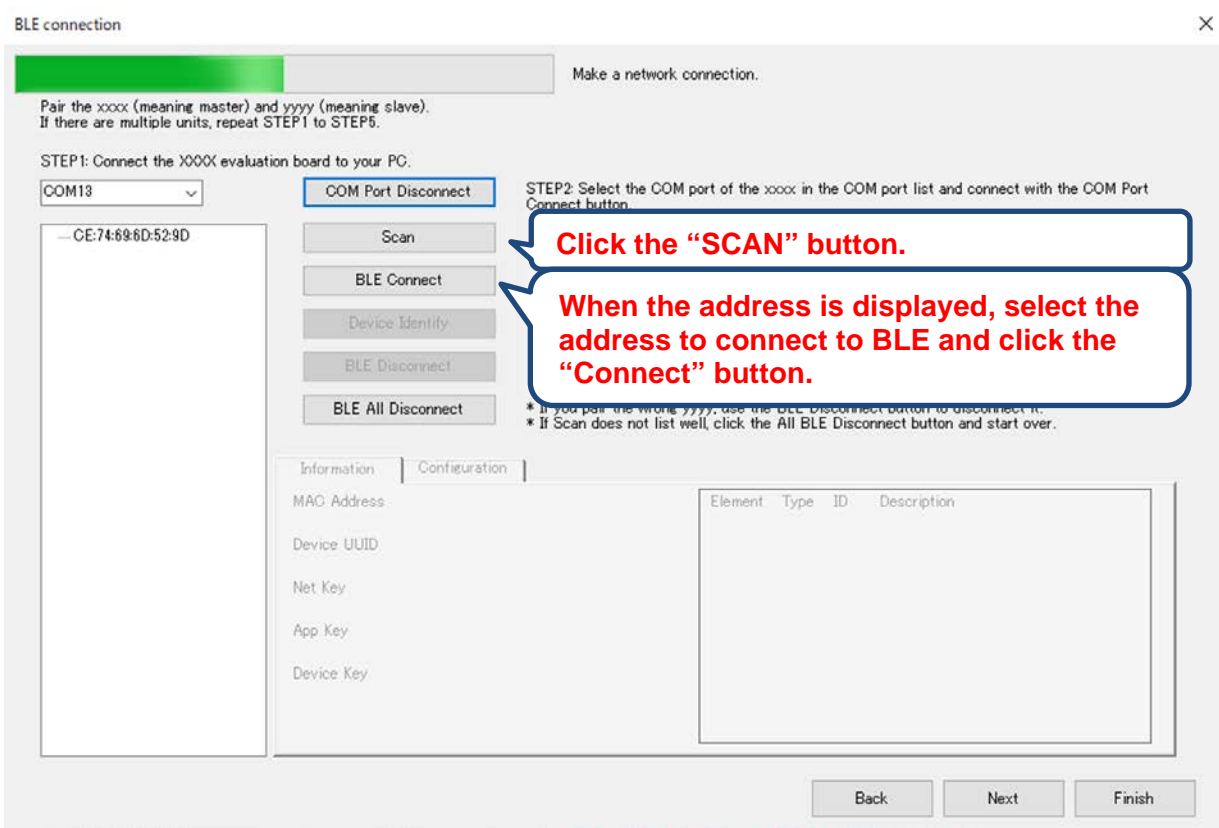

Figure 5-23 BLE connection screen operation(2/3)

- (3)-5 Click the "Identify" button, and when LED0 of the device connected to BLE blinks, the connection is complete.
- (3)-6 Click "Next" button to move to the next screen.

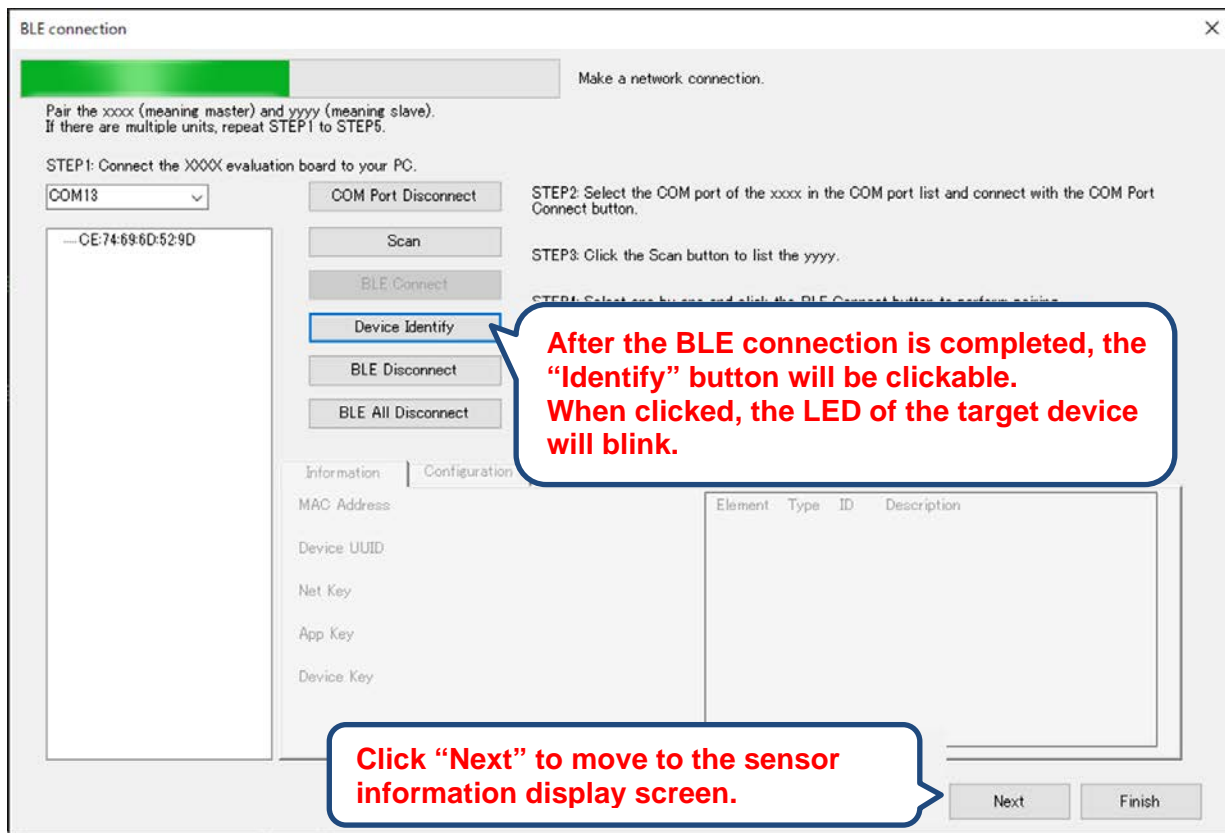

Figure 5-24 BLE connection screen operation(3/3)

(4) Sensor Information screen

(4)-1 The image of the device connected to BLE is displayed in the image display area.
Please rearrange it in any place.

Note It takes about 10 sec to display the image.
If the image is not displayed even after waiting for 10 sec or more and you can confirm that communication is not being performed on the Log View screen, switch the screen with the "Back" button or exit the GUI with the "Close" button ,and Please start again.

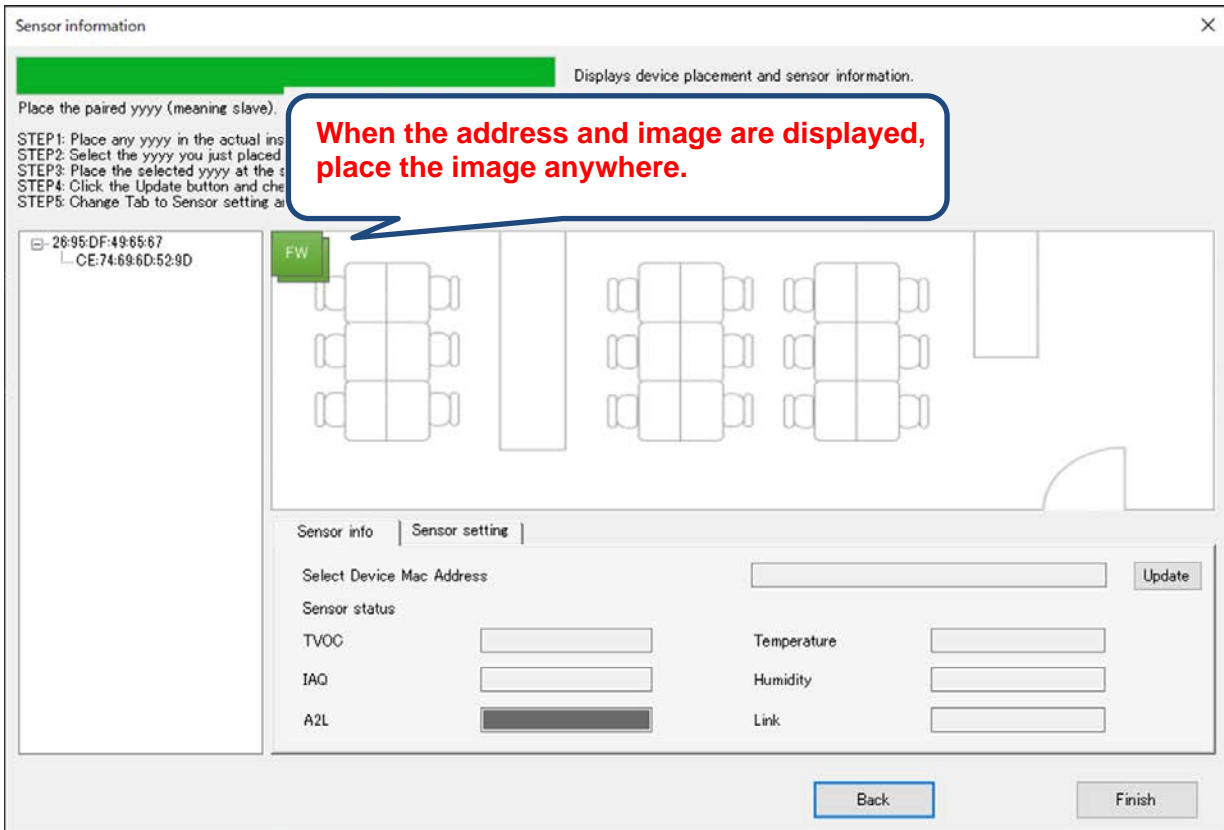

Figure 5-25 Sensor Information screen operation(1/2)

- (4)-2 Clicking on an address or image will display the sensor information for that device in the Sensor info area.
Click the "Update" button to reacquire the sensor information of the device and reflect it in the display.

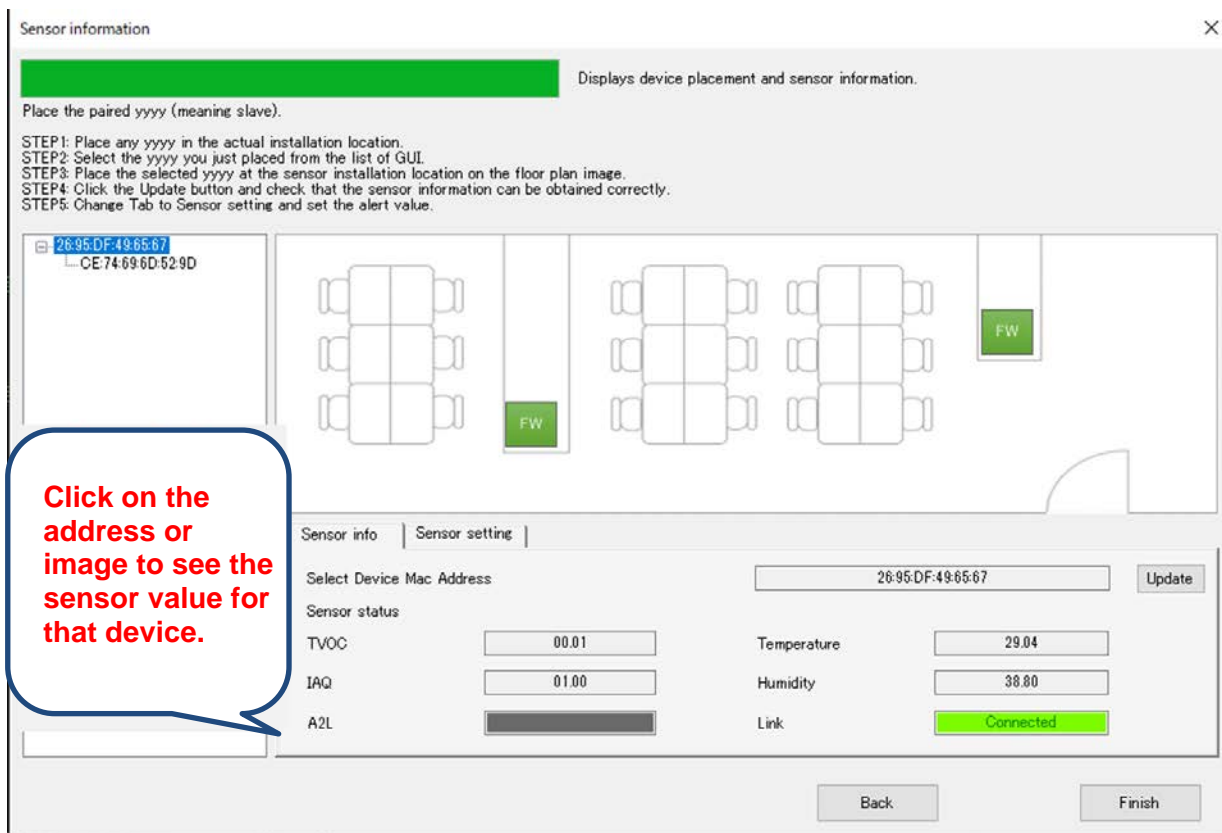

Figure 5-26 Sensor Information screen operation(2/2)

- (4)-3 The "Sensor setting" tab is the area where you can change the TVOC alarm level setting for the currently selected device.
You can change the alarm level by selecting an arbitrary alarm level and clicking the "Apply" button.
- (4)-4 Click the "Finish" button to exit the GUI.
The current BLE connection information and the location of the image are saved in the xml file. The saved contents are used in the Sensor Operation Mode.

Note Please note that if you exit the GUI with the close button, it will not be saved.

5.5.3 Sensor Manufacturing Mode

5.5.3.1 Screen transition

In Sensor Manufacturing mode, screen transitions are performed in the following order by clicking on the "Next" button, except for the boot screen.

- 1. Startup screen
- 2. Address setting screen

If you click the "Back" button, the screen will change in the reverse order.

Click the "Finish" button or "Close" button displayed on each screen to exit the GUI.

Figure 5-27 shows the screen transition when operating in Sensor Manufacturing Mode. In addition, the operating procedure for each screen is described in Chapter 5.5.3.2.

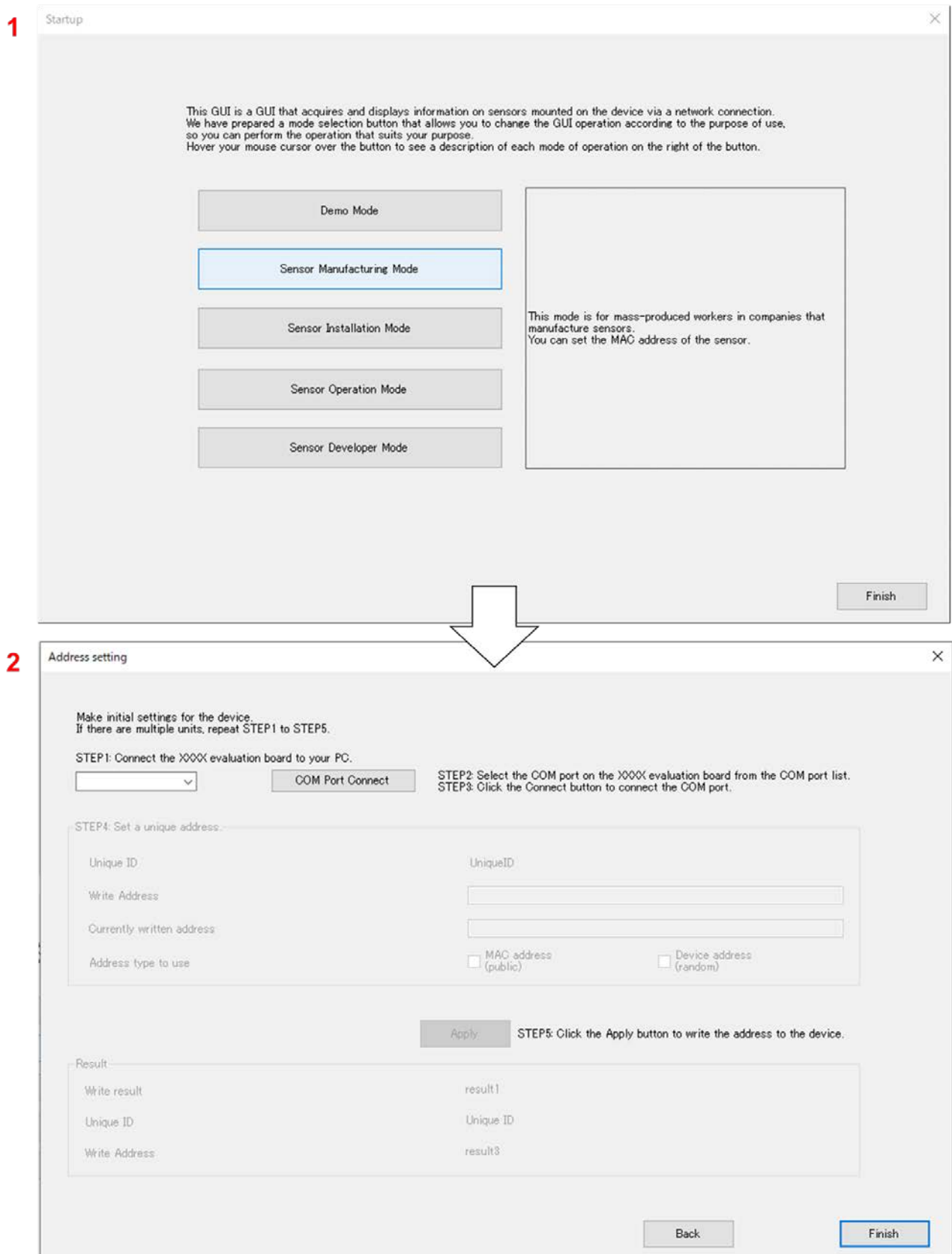

Figure 5-27 Sensor Manufacturing Mode screen transition diagram

5.5.3.2 Operation

The operation method when operating in the Sensor Manufacturing Mode is described in the transition order shown in Figure 5-27.

(1) Startup screen

(1)-1 Click the "Sensor Manufacturing Mode" button.

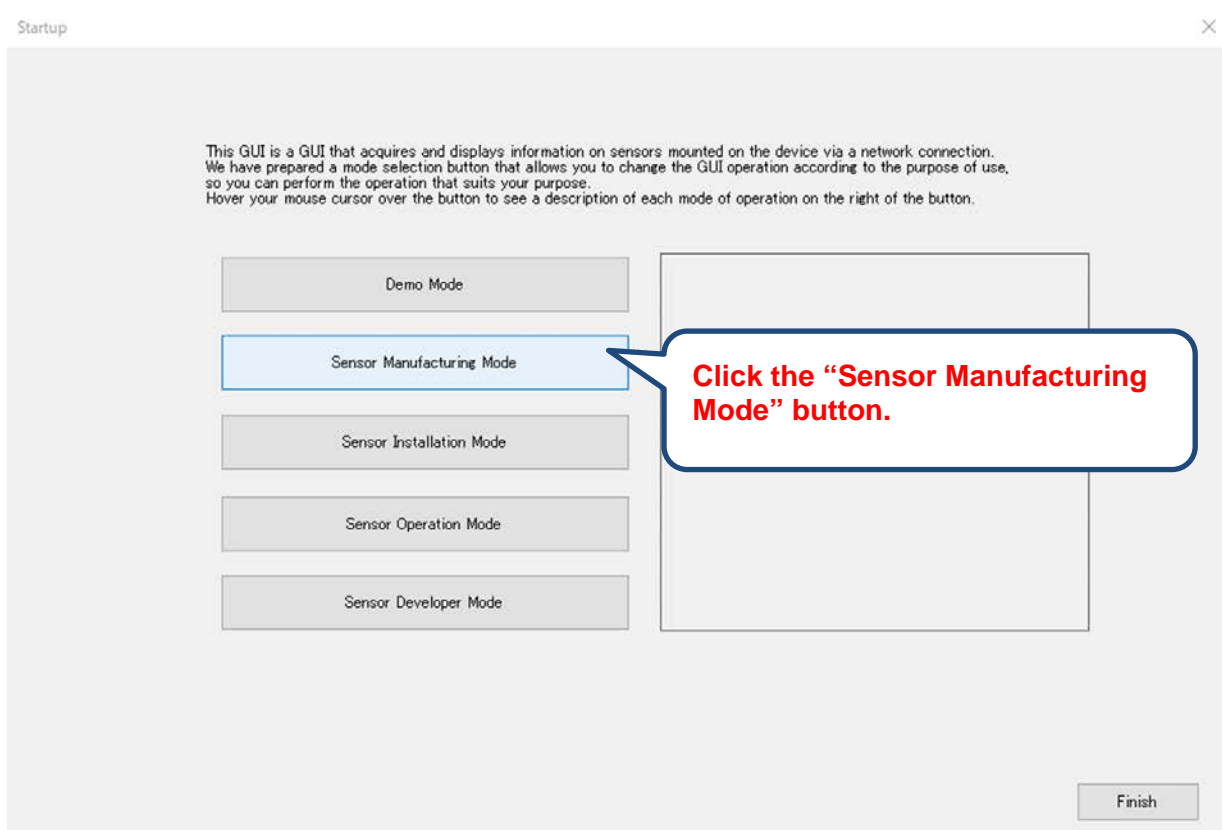

Figure 5-28 Startup screen sensor manufacturing mode operation

(2) Address setting screen

Same as the operation (2)-1 to (2)-6 in Chapter 5.5.2.2(2).

To rewrite the address continuously, click the "COM Port Disconnect" button to end the COM port connection, select another COM port or replace the device, and repeat operations (2)-1 to (2)-6.

5.5.4 Sensor Installation Mode

5.5.4.1 Screen transition

In Sensor Installation mode, screen transitions are performed in the following order by clicking on the "Next" button, except for the boot screen.

- 1. Startup screen
- 2. BLE connection screen
- 3. Select contents screen
- 4. Sensor information screen

If you click the "Back" button, the screen will change in the reverse order.

Click the "Finish" button or "Close" button displayed on each screen to exit the GUI.

Figure 5-29 and Figure 5-30 shows the screen transitions when operating in Sensor Installation mode. In addition, the operating procedure for each screen is described in Chapter 5.5.4.2.

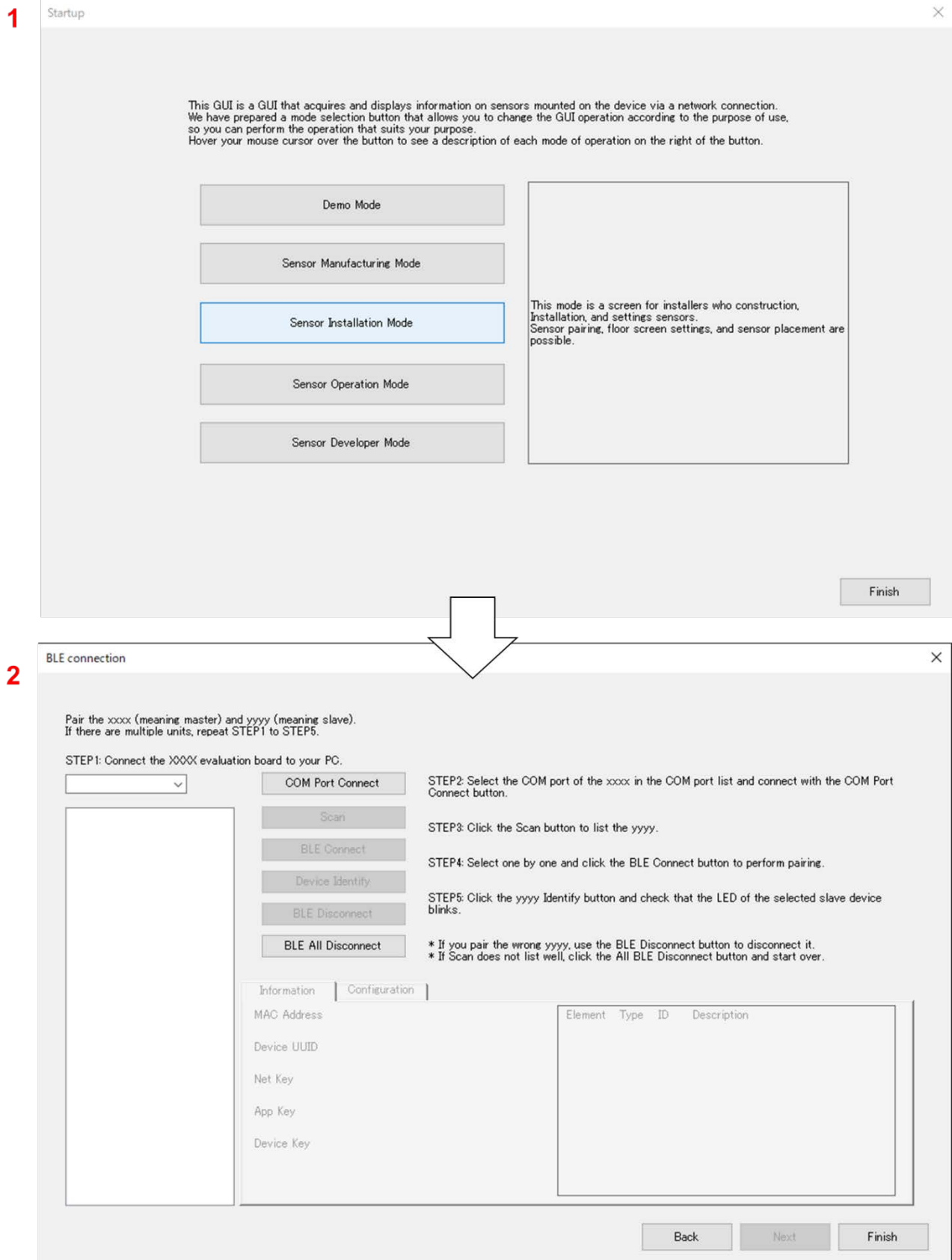

Figure 5-29 Sensor Installation Mode screen transition diagram(1/2)

3

Select contents

Select the content

Specify the floor plan and sensor image to be used when arranging the sensor.

Note: When selecting an image, store the image file in '/ProjectName/UserData' and then make the selection on that image file.

Floor plan image

Sensor image

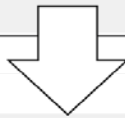

4

Sensor information

Place the paired yyyy (meaning slave).

STEP1: Place any yyyy in the actual installation location.
STEP2: Select the yyyy you just placed from the list of GUI.
STEP3: Place the selected yyyy at the sensor installation location on the floor plan image.
STEP4: Click the Update button and check that the sensor information can be obtained correctly.
STEP5: Change Tab to Sensor setting and set the alert value.

If there are multiple units, repeat the above.

Sensor info | Sensor setting

Select Device Mac Address

Sensor status

TVOC Temperature

IAQ Humidity

A2L Link

Figure 5-30 Sensor Installation Mode screen transition diagram(2/2)

5.5.4.2 Operation

The operation method when operating in the Sensor Installation Mode is described in the transition order shown in Figure 5-29. and Figure 5-30.

(1) Startup screen

(1)-1 Click the "Sensor Installation Mode" button.

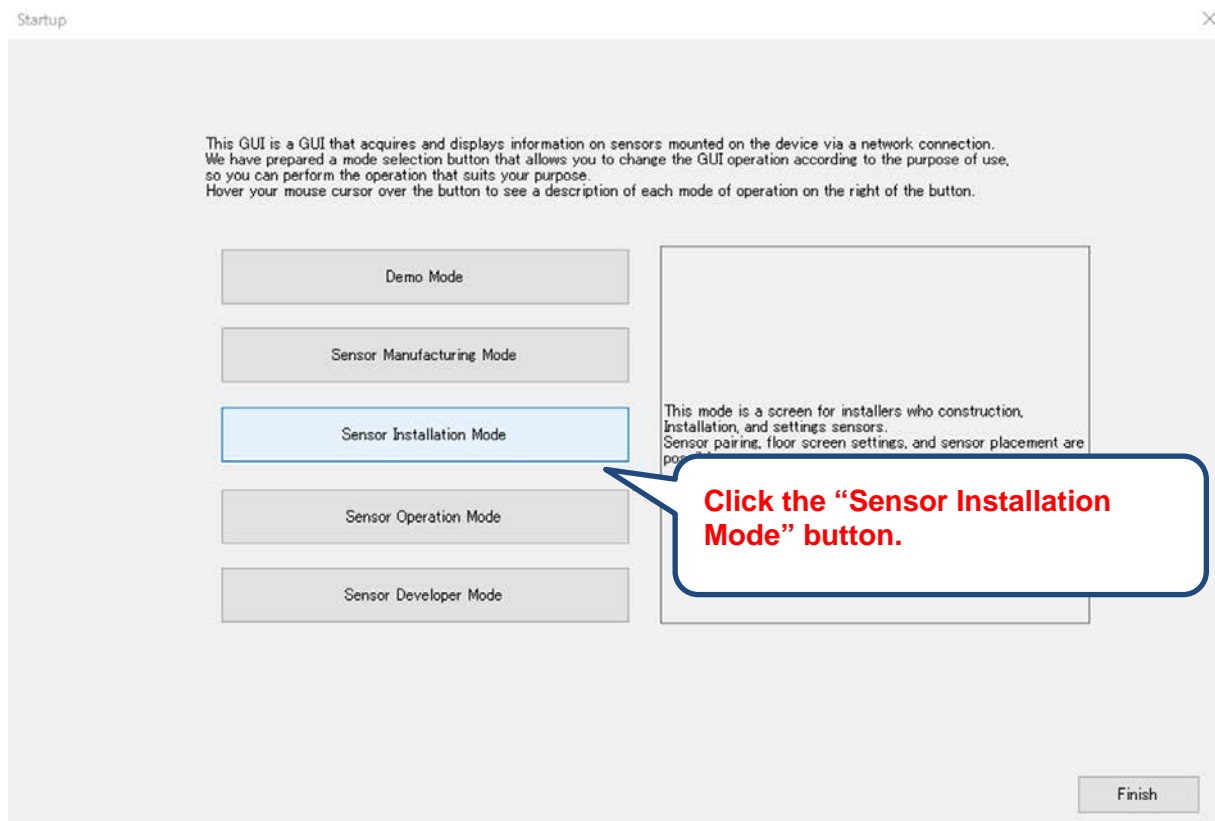

Figure 5-31 Startup screen sensor installation mode operation

(2) BLE connection screen

Same as the operation (3)-1 to (3)-5 in 5.5.2.2(3).

(3) Select contents screen

- (3)-1 Click the "Select" button of "Floor plan image" and the "Select" button of "Sensor image" to display the "Open image file" dialog box. Select any image and click the "Open" button to return to the screen.

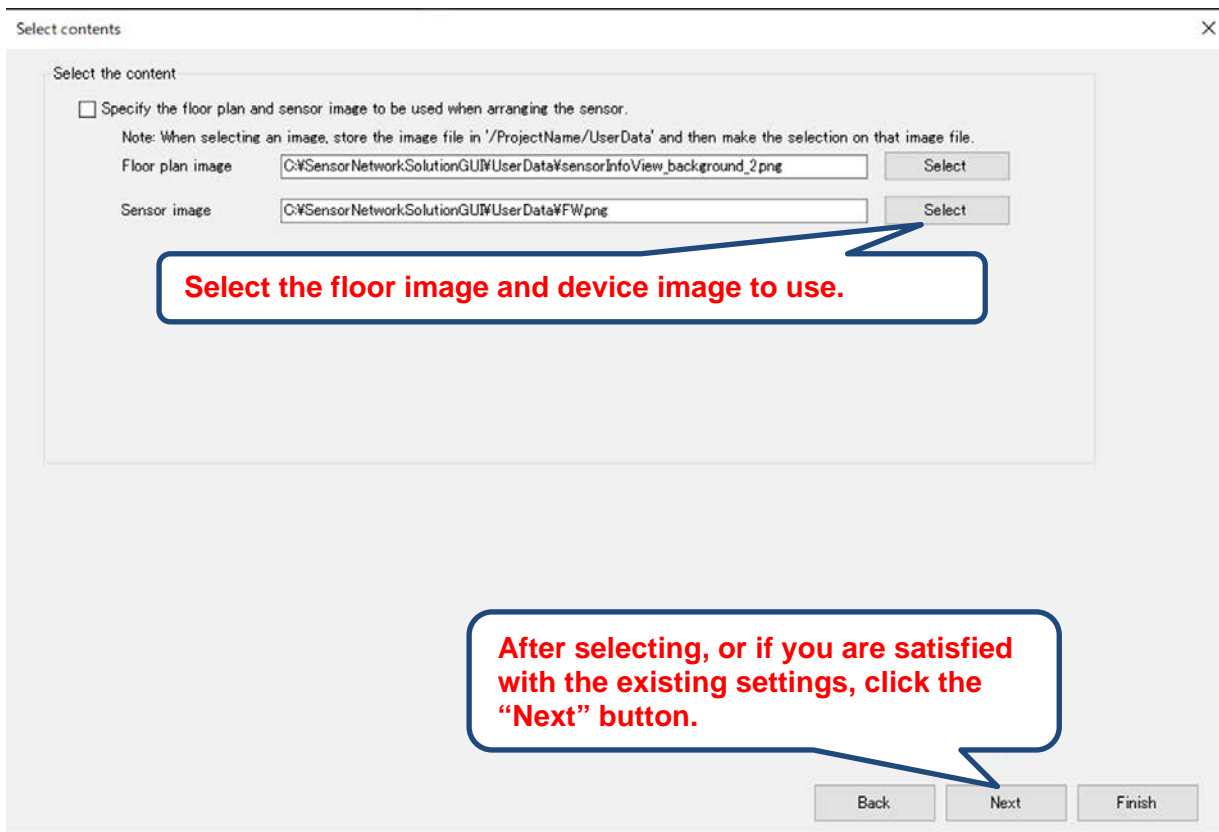

Figure 5-32 Select contents screen operation

(4) Sensor Information screen

Same as the operation in chapter 5.5.2.2(4).

When exiting the GUI, click the "Save, Finish" button to exit the GUI.

The current BLE connection information and the location of the image are saved in the xml file. The saved contents are used in the Sensor Operation Mode.

Note Please note that if you exit the GUI with the close button, it will not be saved.

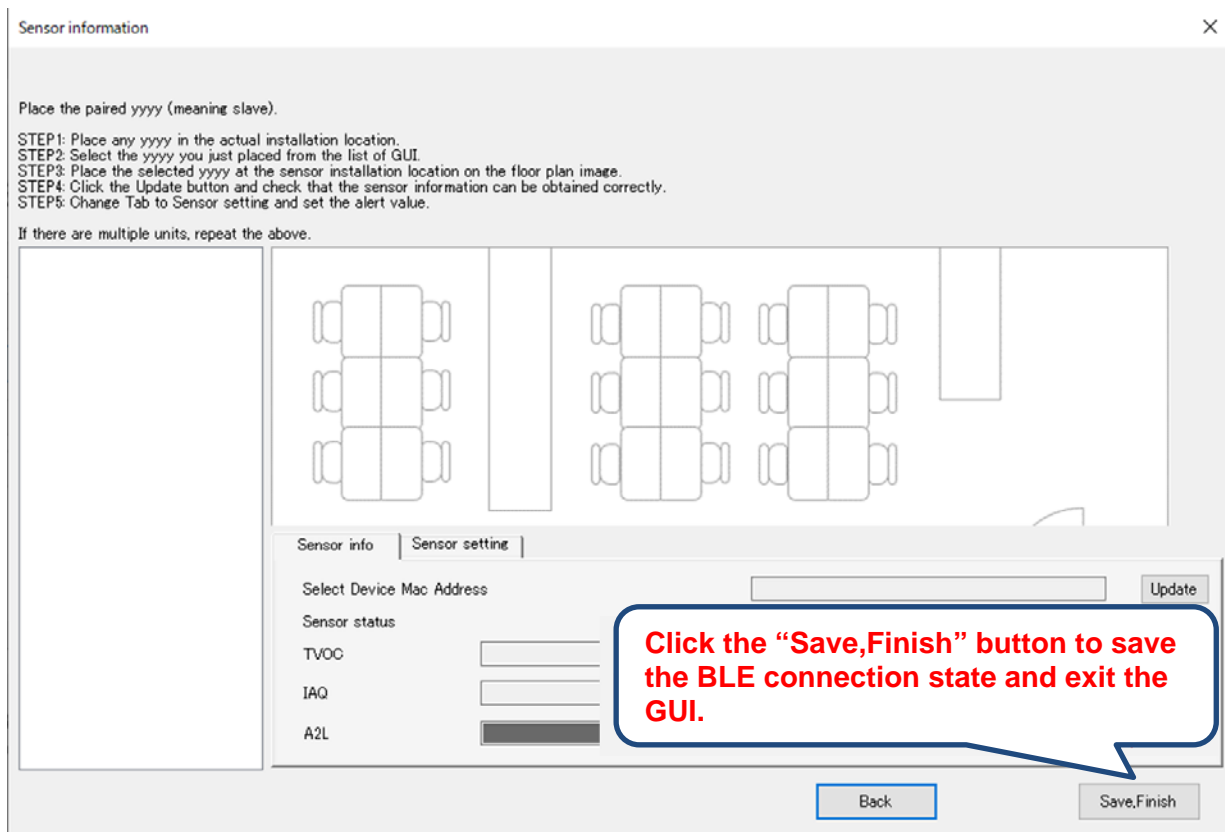

Figure 5-33 Sensor Information screen GUI exit operation

5.5.5 Sensor Operation Mode

5.5.5.1 Screen transition

In Sensor Manufacturing mode, screen transitions are performed in the following order by clicking on the "Next" button, except for the boot screen.

- 1. Startup screen
- 2. Sensor Information screen

If you click the "Back" button, the screen will change in the reverse order.

Click the "Finish" button or "Close" button displayed on each screen to exit the GUI.

Figure 5-34 shows the screen transition when operating in Sensor Operation Mode. In addition, the operating procedure for each screen is described in Chapter 5.5.5.2.

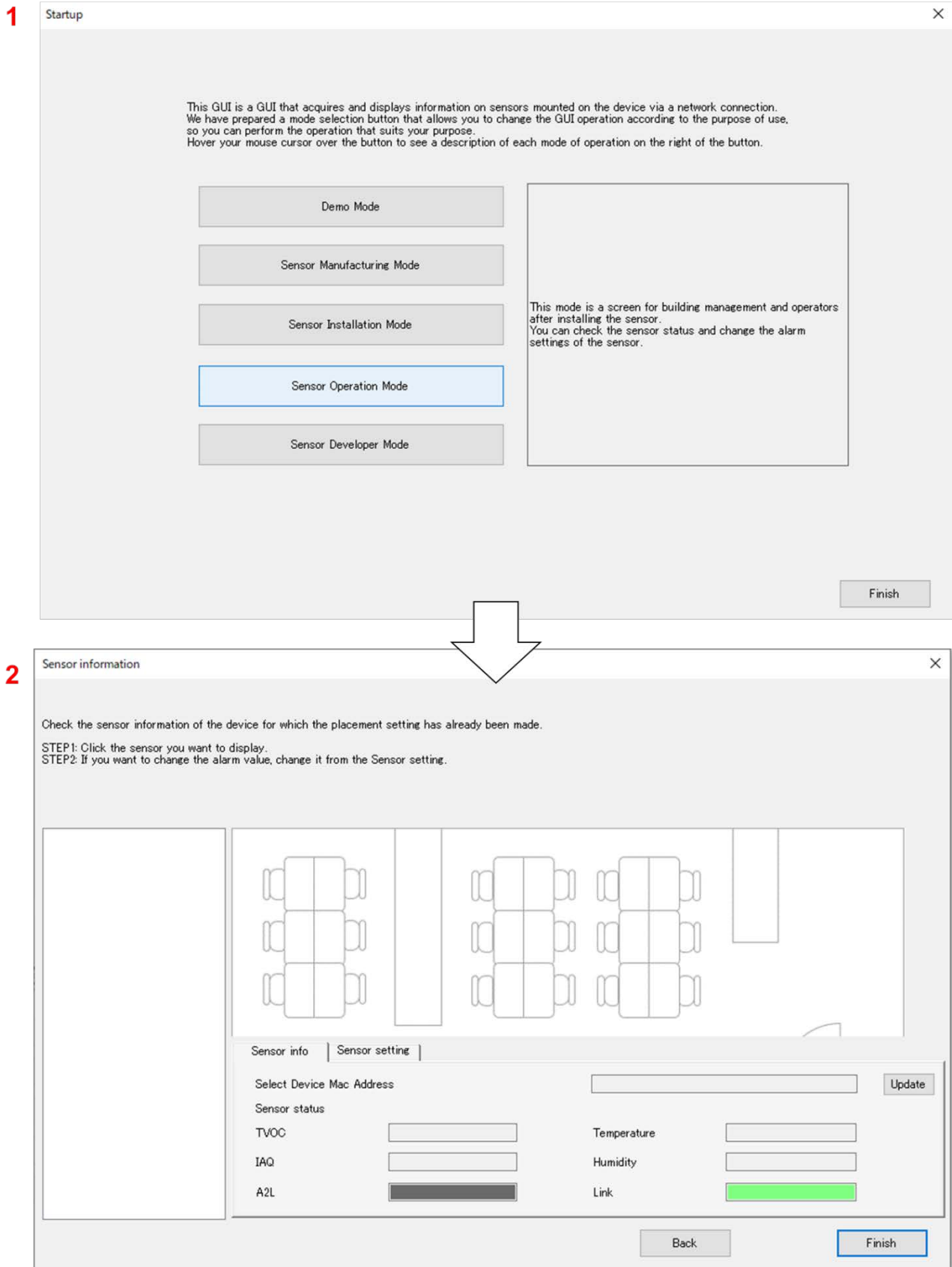

Figure 5-34 Sensor Operation Mode screen transition diagram

5.5.5.2 Operation

The operation method when operating in the Sensor Operation Mode is described in the transition order shown in Figure 5-34.

(1) Startup screen

(1)-1 Click the "Sensor Operation Mode" button.

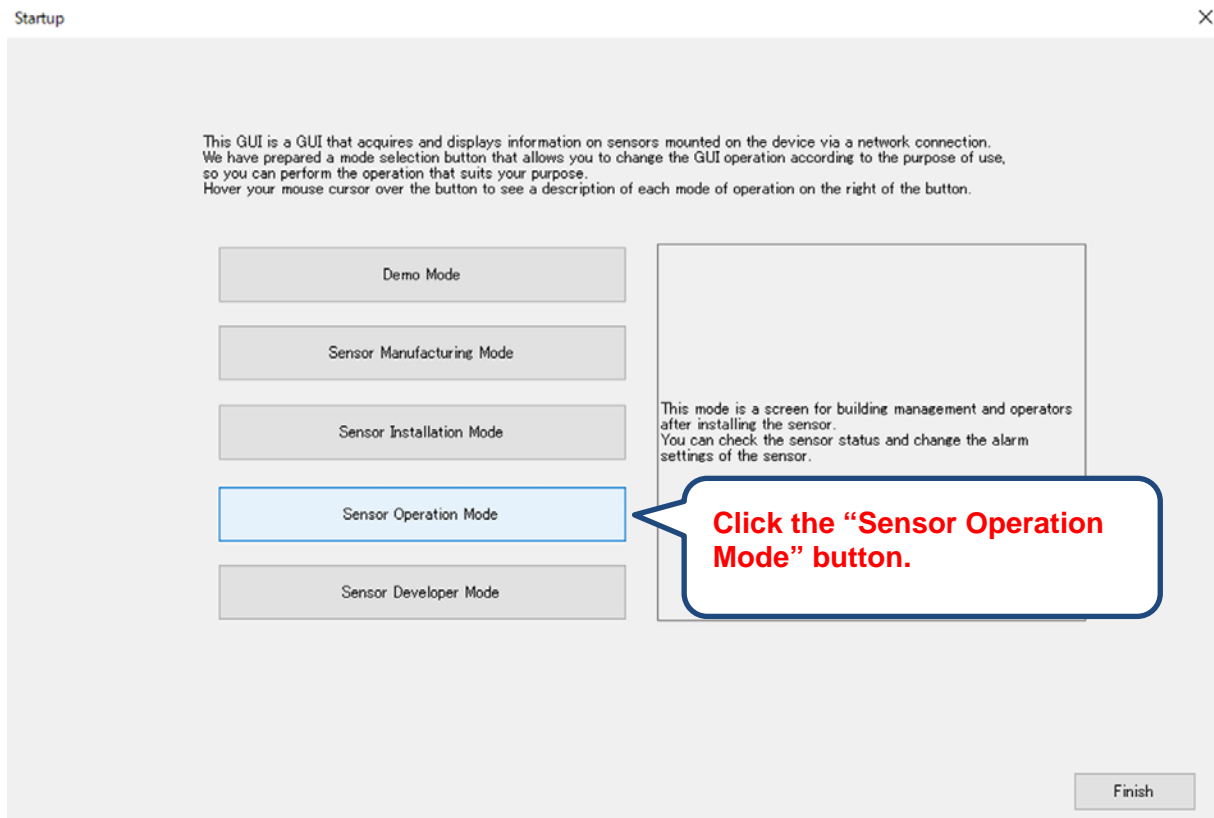

Figure 5-35 Startup screen sensor operation mode operation

(2) Sensor Information screen

Same as the operation in chapter 5.5.2.2(4).

When exiting the GUI, click the " Finish" button to exit the GUI.

Note If you start the Sensor Operation Mode without the BLE connection information according to the Sensor Installation Mode, an error message will be displayed.
If an error message is displayed, perform each operation in the Sensor Installation Mode, save with the "Save,Finish" button, and exit the GUI.

5.5.6 Sensor Developer Mode

5.5.6.1 Screen transition

In Sensor Installation mode, screen transitions are performed in the following order by clicking on the "Next" button, except for the boot screen.

- 1. Startup screen
- 2. BLE connection screen
- 3. GUI operation setting screen
- 4. (Address setting screen)
- 5. Sensor information screen

If you click the "Back" button, the screen will change in the reverse order.

Click the "Setup" button on the GUI operation setting screen to change the 4. Address setting screen, and click the "Back" button to return to the 3. GUI operation setting screen.

Click the "Finish" button or "Close" button displayed on each screen to exit the GUI.

Figure 5-36 and Figure 5-37, Figure 5-38 shows the screen transitions when operating in Sensor Developer mode.

In addition, the operating procedure for each screen is described in Chapter 5.5.6.2.

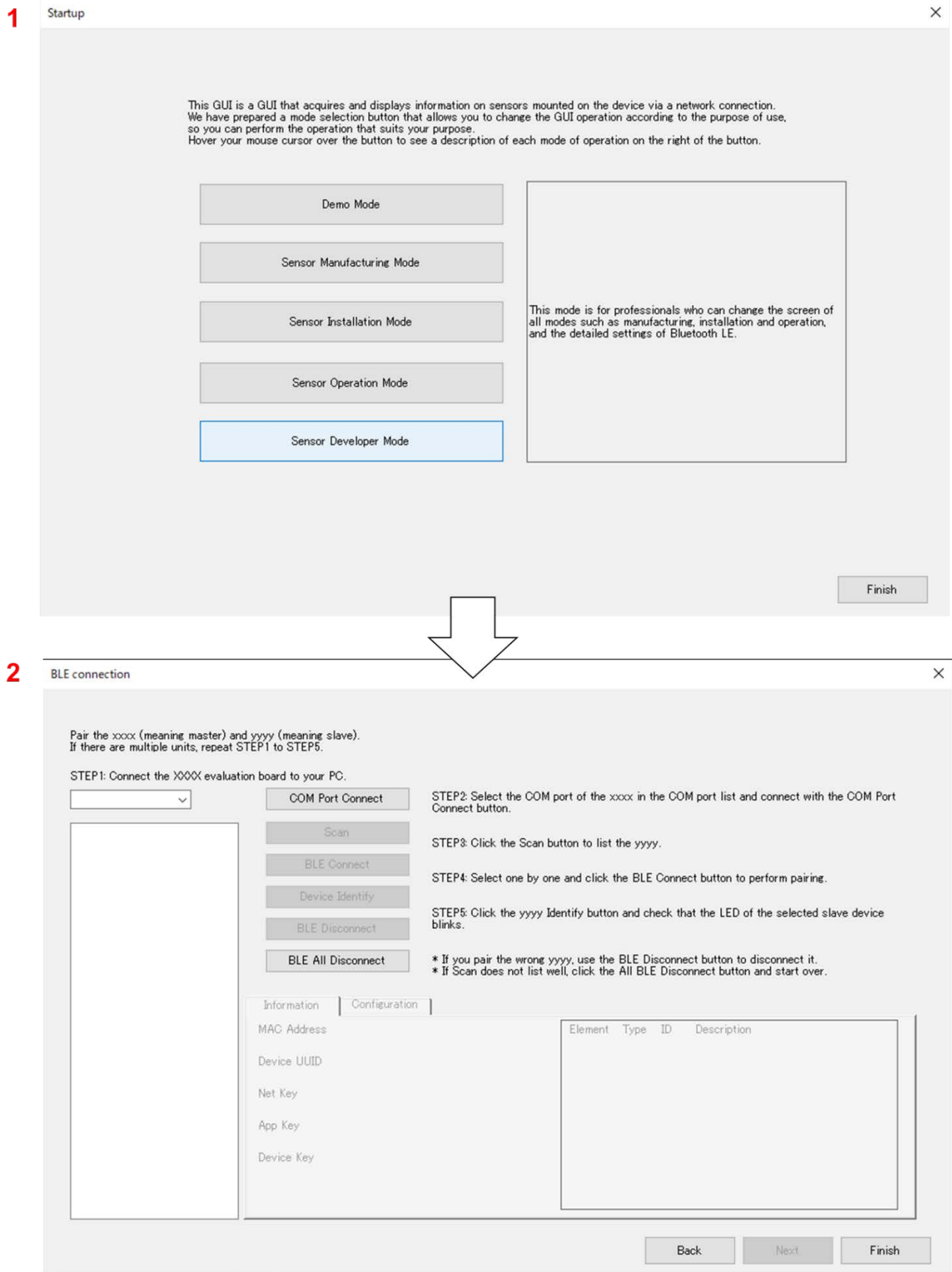

Figure 5-36 Sensor Developer Mode screen transition diagram(1/3)

3

Select contents ✕

Select the content

Specify the floor plan and sensor image to be used when arranging the sensor.
 Note: When selecting an image, store the image file in '/ProjectName/UserData' and then make the selection on that image file.

Floor plan image

Sensor image

Communication type P to P Mesh

Setting device type Master Slaves

With a sensor

Maximum number of Connection devices

Periodic read time of the sensor s

MAC address setting

Press the "Startup" button to open the BLE setting screen.
 On the BLE setting screen, you can make the following settings for devices connected via USB.

- Check / change MAC address
- Change of advertising cycle(T.B.D)
- Change of channels used for advertising(T.B.D), etc.

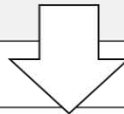

4

Address setting ✕

Make initial settings for the device.
 If there are multiple units, repeat STEP1 to STEP5.

STEP1: Connect the XXXX evaluation board to your PC.

STEP2: Select the COM port on the XXXX evaluation board from the COM port list.
 STEP3: Click the Connect button to connect the COM port.

STEP4: Set a unique address.

Unique ID	<input type="text" value="UniqueID"/>
Write Address	<input type="text"/>
Currently written address	<input type="text"/>
Address type to use	<input type="checkbox"/> MAC address (public) <input type="checkbox"/> Device address (random)

STEP5: Click the Apply button to write the address to the device.

Result

Write result	result1
Unique ID	Unique ID
Write Address	result3

Figure 5-37 Sensor Developer Mode screen transition diagram(2/3)

3

Select contents

Select the content

Specify the floor plan and sensor image to be used when arranging the sensor.
 Note: When selecting an image, store the image file in '/ProjectName/UserData' and then make the selection on that image file.

Floor plan image

Sensor image

Communication type P to P Mesh

Setting device type Master Slaves

With a sensor

Maximum number of Connection devices

Periodic read time of the sensor s

MAC address setting

Press the "Startup" button to open the BLE setting screen.
 On the BLE setting screen, you can make the following settings for devices connected via USB.

- Check / change MAC address
- Change of advertising cycle(T.B.D)
- Change of channels used for advertising(T.B.D), etc.

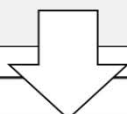

5

Sensor information

Place the paired yyyy (meaning slave).

STEP1: Place any yyyy in the actual installation location.
 STEP2: Select the yyyy you just placed from the list of GUI.
 STEP3: Place the selected yyyy at the sensor installation location on the floor plan image.
 STEP4: Click the Update button and check that the sensor information can be obtained correctly.
 STEP5: Change Tab to Sensor setting and set the alert value.

If there are multiple units, repeat the above.

Sensor info | **Sensor setting**

Select Device Mac Address

Sensor status

TVOC <input type="text"/>	Temperature <input type="text"/>
IAQ <input type="text"/>	Humidity <input type="text"/>
A2L <input type="text"/>	Link <input style="background-color: #90EE90;" type="text"/>

Figure 5-38 Sensor Developer Mode screen transition diagram(3/3)

5.5.6.2 Operation

The operation method when operating in Sensor Developer Mode is described in the transition order shown in Figure 5-36 and Figure 5-37, Figure 5-38.

(1) Startup screen

(1)-1 Click the "Sensor Developer Mode" button.

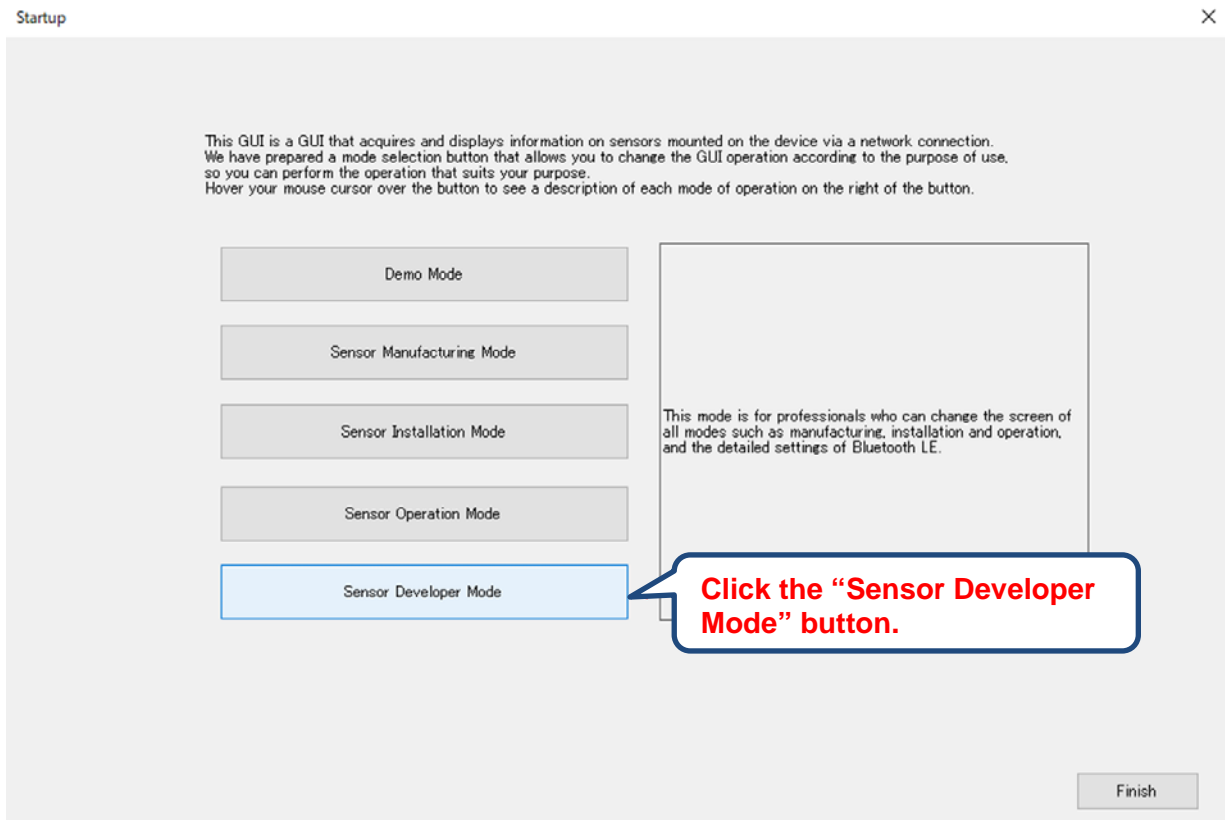

Figure 5-39 Startup screen sensor developer mode operation

(2) BLE connection screen

Same as the operation (3)-1 to (3)-5 in 5.5.2.2(3).

(3) GUI operation setting screen

- (3)-1 If you want to change the image used for the sensor information display screen, uncheck the check box.
- (3)-2 Click the "Select" button of "Floor plan image" to display the "Open image file" dialog box. Select any image and click the "Open" button to return to the screen.
- (3)-3 Click the "Select" button of "Sensor image" to display the "Open image file" dialog box. Select any image and click the "Open" button to return to the screen.

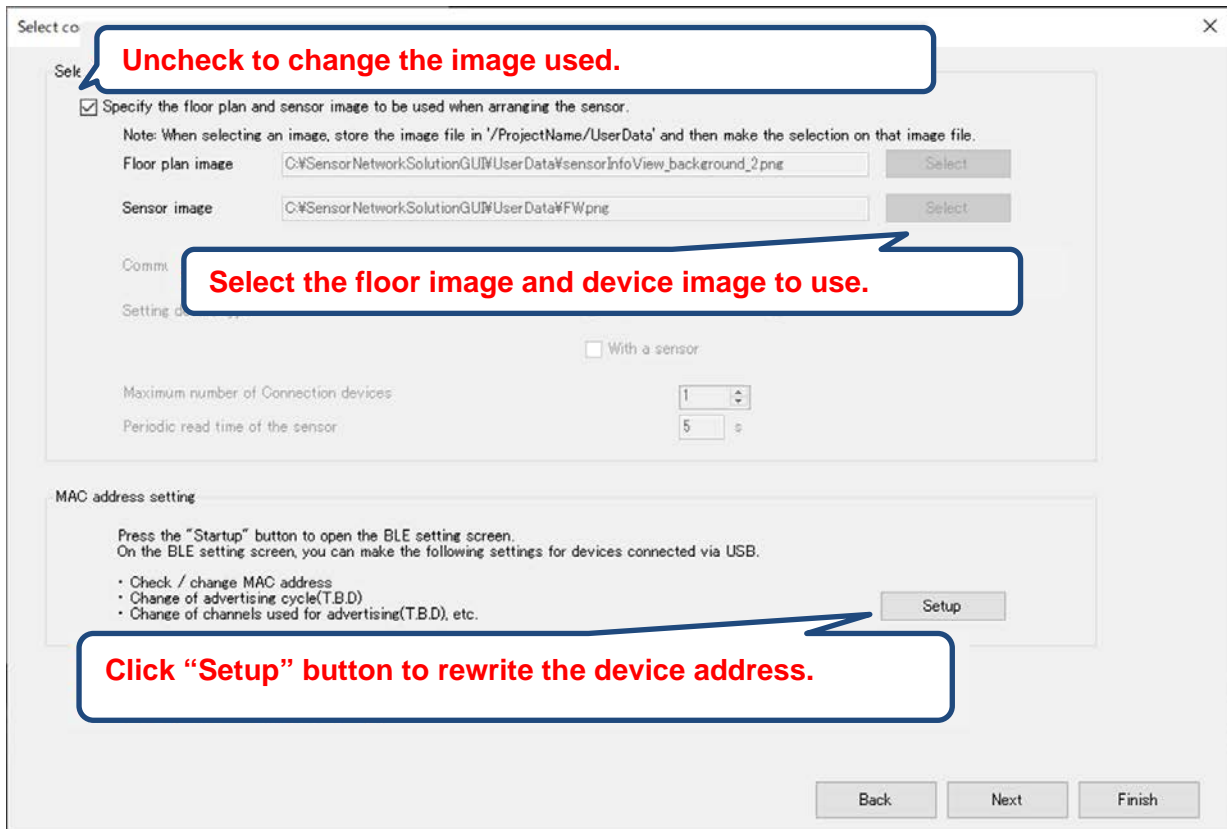

Figure 5-40 GUI operation setting screen operation

(4) Address setting screen

- (4)-1 Click the "Setup" button on the GUI operation setting screen to display the address setting screen.
- (4)-2 The operation of the address setting screen is the same as the operation (2)-1 to (2)-6 in Chapter 5.5.2.2(2).
To rewrite the address continuously, click the "COM Port Disconnect" button to end the COM port connection, select another COM port or replace the device, and repeat operations (2)-1 to (2)-6.
- (4)-3 Click the "Back" button to return to the GUI operation setting screen.

(5) Sensor Information screen

Same as the operation in chapter 5.5.2.2(4).

5.6 RA4W1 independent operation mode

The operation of RA4W1 independent operation mode is described.

- 1. Prepare the EK RA4W1 + sensor board for the master.
- 2. Prepare the EK RA4W1 + sensor board for the slave.
- 3. Use the GUI operation mode to make initial settings for the master and slave in 5.5.3 Sensor Manufacturing Mode and 5.5.4 Sensor Installation Mode.
- 4. Exit the GUI and reset the master and slave.
- 5. Master and slave automatically perform BLE connection and sensor monitoring even if they are not connected to the GUI.
- 6. The master and slave control LED0 and LED1 with the following specifications.
 - If the alarm level of the sensor is lower than the alarm level of its own, LED0 of RA4W1 turns off.
 - For the alarm level of the sensor, if the TVOC value is higher than its own alarm level, LED0 of RA4W1 lights.
 - When the BLE connection between the master and slave is cut off, LED1 of RA4W1 lights up.
 - When the BLE connection is established between the master and slave, LED1 of RA4W1 turns off.
 - Alarm level of the sensor, LED will change when the alarm level is continuously detected twice (The same applies to alarm level notification to GUI)

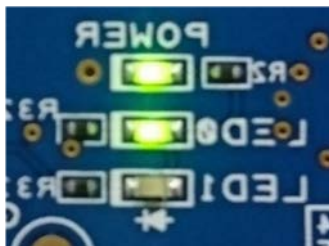

Figure 5-41 LED display image

6. Appendix

6.1 HOST I/F communication specifications

This chapter describes the communication specifications for connecting to the GUI.

6.2 Communication parameters

The communication parameters are listed in Table 6-1.

Table 6-1 Communication parameters

Item	Setting value
Baud rate	115200bps
Data	8 bit
Parity	None
Stop bits	1 bit
Flow Control	none
New-line(Receive)	LF
New-line(Transmit)	CR

6.3 Communication sequence

6.3.1 Basic communication sequence

The basic communication sequence is shown in Figure 6-1.

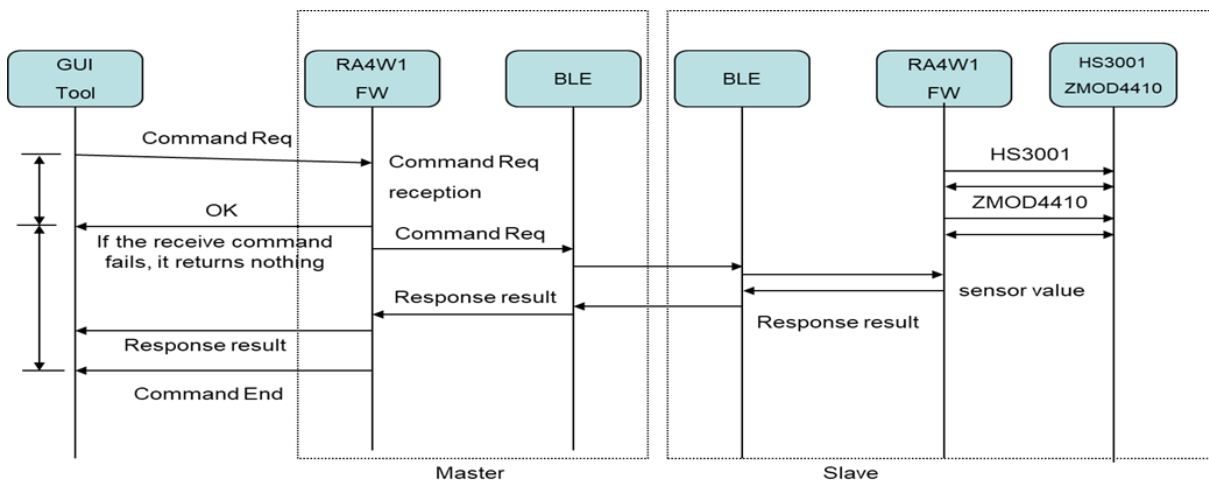

Figure 6-1 Communication sequence

6.4 HOST I/F command specification overview

The HOST I/F command implements the features in Table 6-2.

Table 6-2 HOST I/F command list

Command function	Setting destination	HOST I / F command name		Contents	Master	Slave
BLE network control	BLE	gap	scan	Start Scan	○	-
			scan stop	Stop Scan	○	-
			conn	Connect	○	-
			disconn	Disconnect	○	-
			device	Shows the connected devices	○	-
			auth	Perform pairing / encryption	○	○
Sensor information display (wired connection destination)	RA4W1	rsens_ra4w1	all_sens_val	Get IQA, TVOC, temperature, humidity	○	○
Sensor information display (slave via BLE)	BLE	rsens_ble	all_sens_val	Get IQA, TVOC, temperature, humidity	○	-
Alarm level setting / display (wired)	RA4W1	rsens_ra4w1	zmod4410_notify_level	Alarm level setting	○	-
Alarm level notification permission (wired)	RA4W1	rsens_ra4w1	zmod4410_notify_level_enable	Allow notification of alarm level setting	○	-
Alarm level setting / display (wireless)	BLE	rsens_ble	zmod4410_notify_level	Alarm level setting	○	-
BD address manipulation command	RA4W1 BLE	vs	addr	addr	○	○
Unique ID	RA4W1	vs	fw_info	Read unique ID	○	○
RA4W1 FW returns master or slave				master or slave	○	○
LED blinking command (via wired)	RA4W1	vs	write_led_blink_rate	LED blinking	○	-
LED blinking command (slave via BLE)	BLE	lsc	write_led_blink_rate	LED blinking	○	

6.5 HOST I/F basic command format

The HOST I/F command consists of ASCII characters. It is based on the command line features provided for the RX23W (see r01uw0205jj0101-23wum.pdf in Chapter 5). See below for command sequences, formats, responses, and more.

(1) Command sequence

"gap scan XXXXX" Issue command from GUI or serial console

"\$C1:OK" When accepting command on the RA4W1 side, returns "\$C1:OK "

"\$EV: XXXX" Returns the response to the command on the RA4W1 side

"\$C2:END" After executing the command on the RA4W1 side, notify the completion of the command.

(2) Command issuance format

Specify the "command name argument" with ASCII characters

e.g.) "gap scan XXXXX"

(3) FW response on the RA4W1 side

-1. "\$C1:OK"

If the command is accepted at the first command reception, "\$C1:OK " is returned.

If the command is not accepted, or if an error occurs on the RA4W1 side, no response is returned (RA4W1 could not accept the command).

-2.No response (RA4W1 could not accept command)

-3. "\$EV:XXXX" The response to the command on the RA4W1 side is returned

e.g.) SCAN result

"\$EV: 24:E3:8E:32:02:A4 rnd ff 0000"

-4. "\$C2: END"

After executing the command on the RA4W1 side, notify the completion of the command.

(4) Command example

-1.Start SCAN from GUI

"gap scan"

-2. RA4W1 side accepts commands

"\$C1: OK"

- Response to command

"\$EV: 24:E3:8E:32:02:A4 rnd ff 0000"

-4. "\$C2: END"

Command completion after command execution

6.6 HOST I/F command specifications

The command specifications of HOST I/F are shown below.

6.6.1 BLE network control

(1) Scan command

scan command	
Format	gap scan (filter_ad_type) (filter_data)
	Start scan. To stop scan, enter "scan stop" or [ctrl] + [c].
Parameters:	(filter_ad_type) Specify the AD type to filter. Refer to "Assigned numbers of GAP" for the definition of AD type. Optional if not filtered.
	(filter_data) Specify the Data to filter. Specify the data of AD type specified by filter_ad_type. Optional if not filtered. If filter_ad_type is not used, this parameter cannot be used.
	stop Stop SCAN
Example of use:	<p>"gap scan" Start scan. "gap scan 2 0x01,0x29"</p> <p>Search for advertising reports for services with AD Type: Incomplete List of 16-bit Service Class UUIDs (0x02) and UUID: 0x2901.</p> <p>"gap scan stop" Stop scan.</p>

(2) Connect command

conn command		
Format	gap conn [addr] [addr_type]	
	Send a connection request.	
Parameters:	[addr]	Specify the address of the remote device.
	[addr_type]	Specify one of the following as the address type of the remote device. pub: public address rnd: random address
Example of use:	gap conn 74:90:50:00:95:a8 pub Send a connection request to a remote device with public address of 74:90:50:00:95:a8.	

(3) Disconnect command

disconn command		
Format	gap disconn [conn_hdl]	
	Disconnect the connection.	
Parameters:	[conn_hdl]	Specify the connection handle for the connection to disconnect.
Example of use:	gap disconn 0x0020 Disconnect connection handle: 0x0020.	

(4) Security command

auth command		
Format	gap auth [operation] {params, ...}	
	Perform security operations.	
Parameters:	[operation]	Specify the following as a security operation. start: Start pairing or encryption. del: Delete the key associated with pairing.
	{params,...}	[operation] : When "start" is specified Parameter 1 : Specify the connection handle that indicates the connection to start pairing or encryption.
		[operation] : When "del all" is specified Delete the keys on all remote devices.
Example of use:	gap auth start 0x0026 Start pairing or encryption of the connection handle : 0x0026. gap auth del all Delete the keys on all remote devices.	

6.6.2 Sensor information display

(1) All sensor value acquisition command (wired connection)

all_sens_val	
Format	rsens_ra4w1 all_sens_val
	Get the values of all sensors ZMOD4410, HS3001
Parameters:	None
Example of use:	rsens_ra4w1 all_sens_val “ \$EV:TVOC :XX.XX IAQ:XX.XX TEMP:XX.XX RH:XX.XX”
	TVOC is an ASCII character with an integer (2 digits) and a decimal point (2 digits). IAQ is an ASCII character with an integer (2 digits) and a decimal point (2 digits). TEMP is an ASCII character with a sign ('none' or '-'), an integer (2 digits), and a decimal point (2 digits). RH is an ASCII character with an integer (2 digits) and a decimal point (2 digits).

(2) All sensor value acquisition command (BLE connection)

all_sens_val	
Format	rsens_ble all_sens_val
	Get the values of all sensors ZMOD4410, HS3001
Parameters:	None
Example of use:	rsens_ble all_sens_val “ \$EV:TVOC :XX.XX IAQ:XX.XX TEMP:XX.XX RH:XX.XX”
	TVOC is an ASCII character with an integer (2 digits) and a decimal point (2 digits). IAQ is an ASCII character with an integer (2 digits) and a decimal point (2 digits). TEMP is an ASCII character with a sign ('none' or '-'), an integer (2 digits), and a decimal point (2 digits). RH is an ASCII character with an integer (2 digits) and a decimal point (2 digits).

6.6.3 Alarm Level setting / display

(1) Alarm Level setting / display (Wired)

ZMOD4410_notify_level		
Format	rsens_ra4w1 ZMOD4410_notify_level [level]	
	Set or get the Alarm level	
Parameters:	None	Read the Alarm level
	[level]	Set the Alarm level level:"01"-“05” 2-digit hexadecimal ASCII character
Example of use:	Read: rsens_ra4w1 ZMOD4410_notify_level “\$EV:RA4W1 ALARM LEVEL READ:03” Alarm level setting is 3 Write: rsens_ra4w1 ZMOD4410_notify_level “03” Set Alarm level setting to 3 “\$EV:RA4W1 ALARM LEVEL WRITE:03”	

(2) Alarm Level notification enabled (wired)

ZMOD4410_notify_level_enable		
Format	rsens_ra4w1 ZMOD4410_notify_level_enable [enable]	
	Set or get Alarm level notification enable setting. This is a command for the master. The master notifies the serial console of Alarm level detection from the slave when this setting is enabled.	
Parameters:	None	Read Alarm level notification settings
	[enable]	Allow Alarm level notifications enable:"00"-“01” 2-digit hexadecimal ASCII character
Example of use:	Read: rsens_ra4w1 ZMOD4410_notify_level_enable “\$EV:RA4W1 ALARM LEVEL ENABLE READ: 01” Alarm level notification permission setting is 1 Write: rsens_ra4w1 ZMOD4410_notify_level_enable “01” Set Alarm level notification to allow “\$EV:RA4W1 ALARM LEVEL ENABLE WRITE: 01”	

(3) Alarm level setting / display (BLE)

ZMOD4410_notify_level	
Format	rsens_ble ZMOD4410_notify_level [conn_hdl] Set or get Alarm level via BLE
Parameters:	[conn_hdl] Specify the slave's connection handle.
	None Read the Alarm level
	[level] Set the Alarm level level:"01"-"05" 2-digit hexadecimal ASCII character
Example of use:	<p>Read: rsens_ra4w1 ZMOD4410_notify_level 0x0020 "\$EV:RA4W1 ALARM LEVEL READ:03" The Alarm level setting for conn_hdl (0x0020) is 3.</p> <p>Write: rsens_ra4w1 ZMOD4410_notify_level 0x0020 "03" Set the Alarm level setting for conn_hdl (0x0020) to 3. "\$EV:RA4W1 ALARM LEVEL WRITE:03"</p>

(4) Alarm occurrence notification to GUI (wired)

Alarm occurrence notification (wired)	
Alarm occurrence notification	<p>Alarm occurrence notification to GUI is notified in the following format. "\$EV:ALARM LEVEL:XX TVOC:XX.XX IAQ:XX.XX" LEVEL is an ASCII character with an integer (2 digits). TVOC is an ASCII character with an integer (2 digits) and a decimal point (2 digits). IAQ is an ASCII character with an integer (2 digits) and a decimal point (2 digits).</p>

6.6.4 Configuration command

(1) BD (Bluetooth Device) address operation command

addr command	
Format	vs addr [operation] [area] {params,...} Operate the address of the local device.
Parameters:	[operation] Specify one of the following as the operation for the address of the local device. set: Set the address of the local device. Specify address type, address in {params, ...}. If "df" is specified for [area], the address set after reset will be valid. get: Get the address of the local device. Specify the address type in {params, ...}.
	[area] Specify the location where the address is stored. curr : The temporary address storage location that is currently in use. df: The location where the addresses in Data Flash are stored.
	{params,...} [operation] : When "set" is specified Parameter 1 : Specify the type of address to set. pub: public address rnd: random address Parameter 2 : Specify the address to set. [operation] : When "get" is specified Parameter 1 : Specify the type of address to get. pub: public address rnd: random address
Example of use:	vs addr set df pub 78:90:50:00:95:a8 Set the Data Flash to the public address 78:90:50:00:95:a8. To reflect the setting is necessary to reset the MCU. It is saved in FLASH and the value will be reflected from the next startup. vs addr get curr pub Get the public address currently in use.

(2) Acquisition of individual information for RA4W1

Acquisition of individual information for RA4W1	
Format	vs fw_info Return the unique ID, whether the RA4W1 FW is master or slave
Parameters:	None
Example of use:	vs fw_info "\$EV:ID:XXXXXXX Mode:0" Return the unique ID in ASCII characters RA4W1 FW returns master (0), slave (1)

6.6.5 LED blinking command

(1) LED blinking command (Via wired)

LED blinking command (Via wired)	
Format	vs write_led_blink_rate [rate] EK-RA4W1 board LED0 blinking (Blink off for 10 seconds after receiving a command)
Parameters:	[rate] 1~100 [*100ms] Blink LED0 at rate x 100ms intervals
Example of use:	vs write_led_blink_rate 10 EK-RA4W1 board LED0 blinks in 1 second. After receiving the command, it blinks for 10 seconds and turns off.

(2) LED blinking command (For slave via BLE)

LED blinking command (For slave via BLE)	
Format	lsc write_led_blink_rate [conn_hdl] [rate] Slave EK-RA4W1 board LED0 blinks via BLE (Blinks off for 10 seconds after receiving a command)
Parameters:	[conn_hdl] specify a valid connection handle during the connection. [rate] 1~100 [*100ms] Blink LED0 at rate x 100ms intervals
Example of use:	vs write_led_blink_rate 0020 10 conn_hdl:0x200 The slave EK-RA4W1 board LED0 blinks in 1 second. After receiving the command, it blinks for 10 seconds and turns off. * Master EK-RA4W1 board LED0 does not blink.

Revision History

Rev.	Date	Description	
		Page	Summary
1.0	Feb.10.21	-	First release

General Precautions in the Handling of Microprocessing Unit and Microcontroller Unit Products

The following usage notes are applicable to all Microprocessing unit and Microcontroller unit products from Renesas. For detailed usage notes on the products covered by this document, refer to the relevant sections of the document as well as any technical updates that have been issued for the products.

1. Precaution against Electrostatic Discharge (ESD)

A strong electrical field, when exposed to a CMOS device, can cause destruction of the gate oxide and ultimately degrade the device operation. Steps must be taken to stop the generation of static electricity as much as possible, and quickly dissipate it when it occurs. Environmental control must be adequate. When it is dry, a humidifier should be used. This is recommended to avoid using insulators that can easily build up static electricity.

Semiconductor devices must be stored and transported in an anti-static container, static shielding bag or conductive material. All test and measurement tools including work benches and floors must be grounded. The operator must also be grounded using a wrist strap. Semiconductor devices must not be touched with bare hands. Similar precautions must be taken for printed circuit boards with mounted semiconductor devices.

2. Processing at power-on

The state of the product is undefined at the time when power is supplied. The states of internal circuits in the LSI are indeterminate and the states of register settings and pins are undefined at the time when power is supplied. In a finished product where the reset signal is applied to the external reset pin, the states of pins are not guaranteed from the time when power is supplied until the reset process is completed. In a similar way, the states of pins in a product that is reset by an on-chip power-on reset function are not guaranteed from the time when power is supplied until the power reaches the level at which resetting is specified.

3. Input of signal during power-off state

Do not input signals or an I/O pull-up power supply while the device is powered off. The current injection that results from input of such a signal or I/O pull-up power supply may cause malfunction and the abnormal current that passes in the device at this time may cause degradation of internal elements. Follow the guideline for input signal during power-off state as described in your product documentation.

4. Handling of unused pins

Handle unused pins in accordance with the directions given under handling of unused pins in the manual. The input pins of CMOS products are generally in the high-impedance state. In operation with an unused pin in the open-circuit state, extra electromagnetic noise is induced in the vicinity of the LSI, an associated shoot-through current flows internally, and malfunctions occur due to the false recognition of the pin state as an input signal become possible.

5. Clock signals

After applying a reset, only release the reset line after the operating clock signal becomes stable. When switching the clock signal during program execution, wait until the target clock signal is stabilized. When the clock signal is generated with an external resonator or from an external oscillator during a reset, ensure that the reset line is only released after full stabilization of the clock signal. Additionally, when switching to a clock signal produced with an external resonator or by an external oscillator while program execution is in progress, wait until the target clock signal is stable.

6. Voltage application waveform at input pin

Waveform distortion due to input noise or a reflected wave may cause malfunction. If the input of the CMOS device stays in the area between V_{IL} (Max.) and V_{IH} (Min.) due to noise, for example, the device may malfunction. Take care to prevent chattering noise from entering the device when the input level is fixed, and also in the transition period when the input level passes through the area between V_{IL} (Max.) and V_{IH} (Min.).

7. Prohibition of access to reserved addresses

Access to reserved addresses is prohibited. The reserved addresses are provided for possible future expansion of functions. Do not access these addresses as the correct operation of the LSI is not guaranteed.

8. Differences between products

Before changing from one product to another, for example to a product with a different part number, confirm that the change will not lead to problems. The characteristics of a microprocessing unit or microcontroller unit products in the same group but having a different part number might differ in terms of internal memory capacity, layout pattern, and other factors, which can affect the ranges of electrical characteristics, such as characteristic values, operating margins, immunity to noise, and amount of radiated noise. When changing to a product with a different part number, implement a system-evaluation test for the given product.

Notice

1. Descriptions of circuits, software and other related information in this document are provided only to illustrate the operation of semiconductor products and application examples. You are fully responsible for the incorporation or any other use of the circuits, software, and information in the design of your product or system. Renesas Electronics disclaims any and all liability for any losses and damages incurred by you or third parties arising from the use of these circuits, software, or information.
2. Renesas Electronics hereby expressly disclaims any warranties against and liability for infringement or any other claims involving patents, copyrights, or other intellectual property rights of third parties, by or arising from the use of Renesas Electronics products or technical information described in this document, including but not limited to, the product data, drawings, charts, programs, algorithms, and application examples.
3. No license, express, implied or otherwise, is granted hereby under any patents, copyrights or other intellectual property rights of Renesas Electronics or others.
4. You shall be responsible for determining what licenses are required from any third parties, and obtaining such licenses for the lawful import, export, manufacture, sales, utilization, distribution or other disposal of any products incorporating Renesas Electronics products, if required.
5. You shall not alter, modify, copy, or reverse engineer any Renesas Electronics product, whether in whole or in part. Renesas Electronics disclaims any and all liability for any losses or damages incurred by you or third parties arising from such alteration, modification, copying or reverse engineering.
6. Renesas Electronics products are classified according to the following two quality grades: "Standard" and "High Quality". The intended applications for each Renesas Electronics product depends on the product's quality grade, as indicated below.
 - "Standard": Computers; office equipment; communications equipment; test and measurement equipment; audio and visual equipment; home electronic appliances; machine tools; personal electronic equipment; industrial robots; etc.
 - "High Quality": Transportation equipment (automobiles, trains, ships, etc.); traffic control (traffic lights); large-scale communication equipment; key financial terminal systems; safety control equipment; etc.Unless expressly designated as a high reliability product or a product for harsh environments in a Renesas Electronics data sheet or other Renesas Electronics document, Renesas Electronics products are not intended or authorized for use in products or systems that may pose a direct threat to human life or bodily injury (artificial life support devices or systems; surgical implantations; etc.), or may cause serious property damage (space system; undersea repeaters; nuclear power control systems; aircraft control systems; key plant systems; military equipment; etc.). Renesas Electronics disclaims any and all liability for any damages or losses incurred by you or any third parties arising from the use of any Renesas Electronics product that is inconsistent with any Renesas Electronics data sheet, user's manual or other Renesas Electronics document.
7. No semiconductor product is absolutely secure. Notwithstanding any security measures or features that may be implemented in Renesas Electronics hardware or software products, Renesas Electronics shall have absolutely no liability arising out of any vulnerability or security breach, including but not limited to any unauthorized access to or use of a Renesas Electronics product or a system that uses a Renesas Electronics product. RENESAS ELECTRONICS DOES NOT WARRANT OR GUARANTEE THAT RENESAS ELECTRONICS PRODUCTS, OR ANY SYSTEMS CREATED USING RENESAS ELECTRONICS PRODUCTS WILL BE INVULNERABLE OR FREE FROM CORRUPTION, ATTACK, VIRUSES, INTERFERENCE, HACKING, DATA LOSS OR THEFT, OR OTHER SECURITY INTRUSION ("Vulnerability Issues"). RENESAS ELECTRONICS DISCLAIMS ANY AND ALL RESPONSIBILITY OR LIABILITY ARISING FROM OR RELATED TO ANY VULNERABILITY ISSUES. FURTHERMORE, TO THE EXTENT PERMITTED BY APPLICABLE LAW, RENESAS ELECTRONICS DISCLAIMS ANY AND ALL WARRANTIES, EXPRESS OR IMPLIED, WITH RESPECT TO THIS DOCUMENT AND ANY RELATED OR ACCOMPANYING SOFTWARE OR HARDWARE, INCLUDING BUT NOT LIMITED TO THE IMPLIED WARRANTIES OF MERCHANTABILITY, OR FITNESS FOR A PARTICULAR PURPOSE.
8. When using Renesas Electronics products, refer to the latest product information (data sheets, user's manuals, application notes, "General Notes for Handling and Using Semiconductor Devices" in the reliability handbook, etc.), and ensure that usage conditions are within the ranges specified by Renesas Electronics with respect to maximum ratings, operating power supply voltage range, heat dissipation characteristics, installation, etc. Renesas Electronics disclaims any and all liability for any malfunctions, failure or accident arising out of the use of Renesas Electronics products outside of such specified ranges.
9. Although Renesas Electronics endeavors to improve the quality and reliability of Renesas Electronics products, semiconductor products have specific characteristics, such as the occurrence of failure at a certain rate and malfunctions under certain use conditions. Unless designated as a high reliability product or a product for harsh environments in a Renesas Electronics data sheet or other Renesas Electronics document, Renesas Electronics products are not subject to radiation resistance design. You are responsible for implementing safety measures to guard against the possibility of bodily injury, injury or damage caused by fire, and/or danger to the public in the event of a failure or malfunction of Renesas Electronics products, such as safety design for hardware and software, including but not limited to redundancy, fire control and malfunction prevention, appropriate treatment for aging degradation or any other appropriate measures. Because the evaluation of microcomputer software alone is very difficult and impractical, you are responsible for evaluating the safety of the final products or systems manufactured by you.
10. Please contact a Renesas Electronics sales office for details as to environmental matters such as the environmental compatibility of each Renesas Electronics product. You are responsible for carefully and sufficiently investigating applicable laws and regulations that regulate the inclusion or use of controlled substances, including without limitation, the EU RoHS Directive, and using Renesas Electronics products in compliance with all these applicable laws and regulations. Renesas Electronics disclaims any and all liability for damages or losses occurring as a result of your noncompliance with applicable laws and regulations.
11. Renesas Electronics products and technologies shall not be used for or incorporated into any products or systems whose manufacture, use, or sale is prohibited under any applicable domestic or foreign laws or regulations. You shall comply with any applicable export control laws and regulations promulgated and administered by the governments of any countries asserting jurisdiction over the parties or transactions.
12. It is the responsibility of the buyer or distributor of Renesas Electronics products, or any other party who distributes, disposes of, or otherwise sells or transfers the product to a third party, to notify such third party in advance of the contents and conditions set forth in this document.
13. This document shall not be reprinted, reproduced or duplicated in any form, in whole or in part, without prior written consent of Renesas Electronics.
14. Please contact a Renesas Electronics sales office if you have any questions regarding the information contained in this document or Renesas Electronics products.

(Note1) "Renesas Electronics" as used in this document means Renesas Electronics Corporation and also includes its directly or indirectly controlled subsidiaries.

(Note2) "Renesas Electronics product(s)" means any product developed or manufactured by or for Renesas Electronics.

(Rev.5.0-1 October 2020)

Corporate Headquarters

TOYOSU FORESIA, 3-2-24 Toyosu,
Koto-ku, Tokyo 135-0061, Japan
www.renesas.com

Trademarks

Renesas and the Renesas logo are trademarks of Renesas Electronics Corporation. All trademarks and registered trademarks are the property of their respective owners.

Contact information

For further information on a product, technology, the most up-to-date version of a document, or your nearest sales office, please visit:
www.renesas.com/contact/.