

---

## RA2A1 Group

### QE for AFE[RA] Analog Front End Tuning Guide

---

#### Introduction

This document is an operation manual of “QE for AFE [RA]” (call QE for AFE below) that is connected to Evaluation Kit for RA2A1 MCU Group (EK-RA2A1 board) for operation. For details of the MCU, refer to “RA2A1 Group User’s Manual: Hardware”.

The QE for AFE is used in combination with “RA2A1 Group Board Control Program for QE for AFE” which is included in the QE for AFE.

#### Target Device

RA2A (R7FA2A1AB3CFM)

#### Board to Be Operated

Evaluation Kit for RA2A1 Microcontroller Group: EK-RA2A1

## Contents

1. Overview .....	4
1.1 System Overview.....	4
1.2 Operating Environment .....	5
1.3 References .....	5
2. Preparation.....	6
2.1 Installation of the QE for AFE.....	6
2.1.1 Update of the QE for AFE .....	7
2.1.2 Uninstall of the QE for AFE .....	7
2.2 Programming of the board control program for the QE for AFE .....	7
2.3 Settings of the target board .....	7
2.3.1 Set the operating mode to “Single-chip mode”.....	7
2.3.2 Reference voltage pin connection setting when using ADC16 .....	7
3. Connection .....	8
3.1 Precautions when connecting UART.....	9
3.1.1 Do not use power supply function of USB-UART adapter .....	9
3.1.2 Baud-rate changing procedure.....	9
4. Evaluation Examples .....	10
4.1 Evaluation Procedure .....	10
4.1.1 Preparation.....	11
4.1.2 Connect host PC to the target board.....	11
4.1.3 Connect the QE for AFE and the target board.....	11
4.1.4 Import the register setting file.....	12
4.1.5 Configuration of DAC8 .....	13
4.1.6 Configuration of OPAMP .....	14
4.1.7 Configuration of ADC16 .....	15
4.1.8 Confirmation of connection.....	16
4.1.9 Reflection to RA2A1 .....	17
4.1.10 Start tuning .....	18
4.1.11 Display of the graph .....	19
4.2 Evaluation example of SDADC24 .....	20
4.3 Evaluation example of ADC16 .....	22
4.4 Evaluation example of ACMPHS.....	24
4.5 Evaluation example of ACMPLP .....	27
5. Explanation of Functions .....	30
5.1 AFE Connection .....	31
5.1.1 Common Functions .....	31
5.1.2 Connection tab .....	34

---

5.1.3	SDADC24 tab .....	35
5.1.4	ADC16 tab .....	37
5.1.5	OPAMP tab.....	39
5.1.6	DAC8 tab .....	41
5.1.7	DAC12 tab .....	43
5.1.8	ACMPHS tab .....	45
5.1.9	ACMPLP tab.....	47
5.2	Monitor.....	49
5.2.1	Common functions .....	49
5.2.2	Display of the waveform .....	52
5.2.3	Display of the histogram.....	53
5.2.4	Display of raw data .....	54
5.3	Filter.....	55
5.3.1	Frequency characteristics of SINC3.....	56
5.4	Calibration .....	57
	Revision History.....	58

# 1. Overview

## 1.1 System Overview

The QE for AFE is a development assistance tool that supports the development of embedded systems that perform highly accurate sensing using microcontrollers with a built-in AFE. The QE for AFE perform serial communication with the EK-RA2A1 board (called target board below) via USB connection to set the registers of the AFE, control operation of the AFE, and obtain and display A/D conversion values as a graph. The QE for AFE is a stand-alone tool (.exe) that runs on your local PC.

The main functions are listed below.

- (1) Perform the following operations with serial communication through the target board by USB connection.
  - Checks the connection with the target board.
  - Obtains and sets RA2A1 register values.
  - Requests the target board to start and stop A/D conversion and comparator operation.
  - Obtains A/D conversion values / comparator output (A/D conversion performs the continuous scan mode).
- (2) Analyzes and displays the obtained A/D conversion values / comparator output as follows.
  - Displays a waveform of the A/D conversion values or comparator output.
  - Analyzes and displays a histogram of the A/D conversion values.
  - Displays various measurement results.
- (3) Obtains and sets AFE register setting values.
  - Selects and specifies register parameters in a block diagram.
  - Displays the register setting values for parameter.
  - Displays a SINC3 filter frequency-gain characteristic graph based on register setting value.

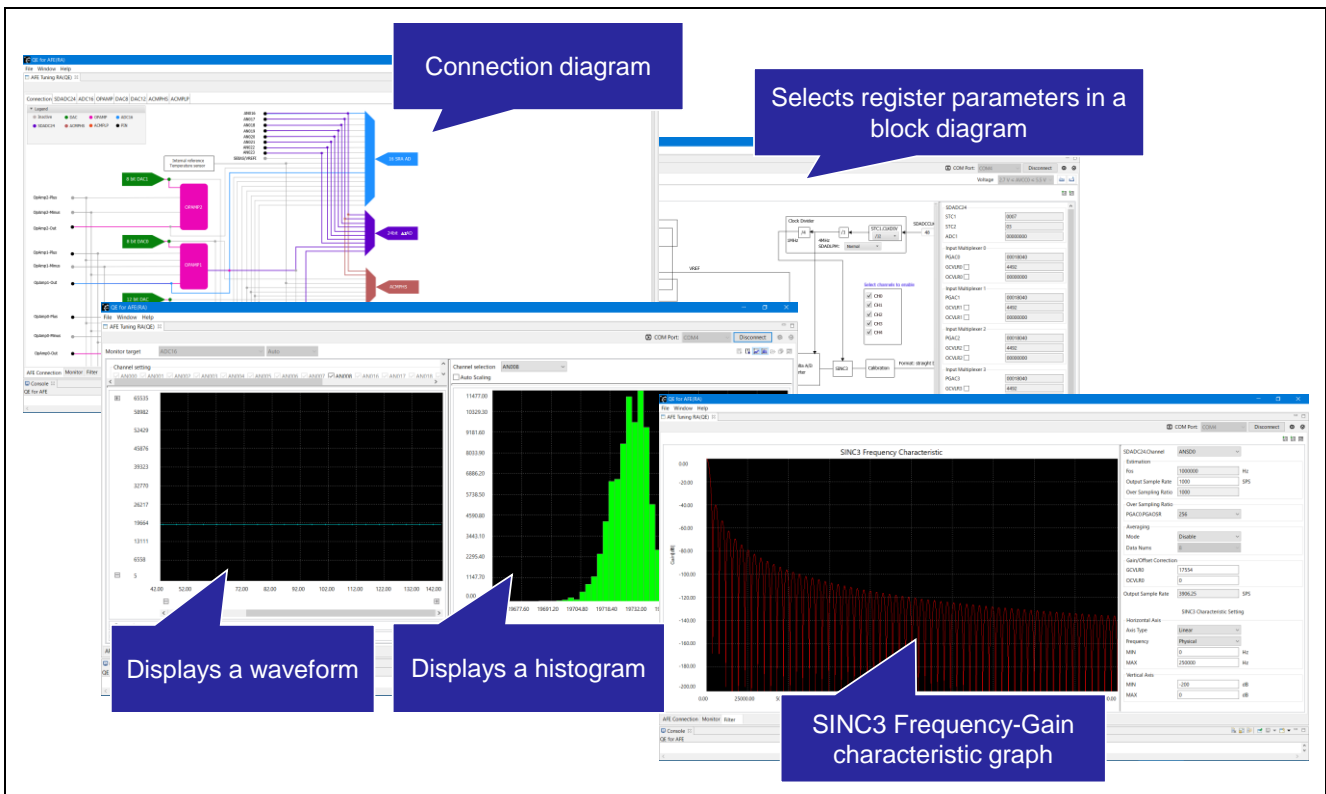


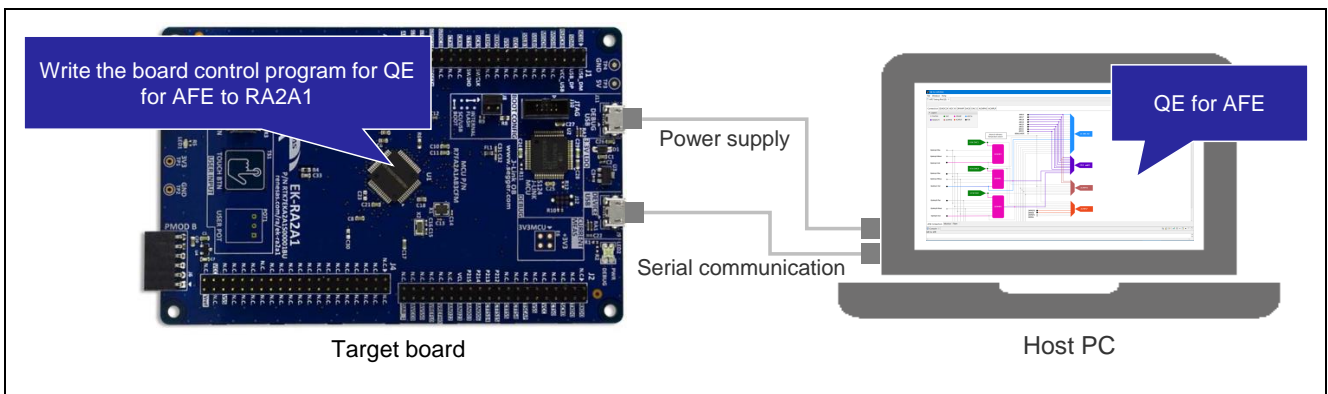
Figure 1-1 Main functions of the QE for AFE

### 1.2 Operating Environment

The operating environment of the QE for AFE is as follows.

**Table 1-1 Conditions for operation**

Item	Details	Remark
OS of host PC	Windows10 (64bit)	-
Target board	EK-RA2A1 board	-
QE for AFE	QE for AFE[RA] V1.10	-
Board control program for the QE for AFE	QE_for_AFE_uart QE_for_AFE_usb	Please refer to R01AN5795 Application Note: RA2A1 Group Board Control Program for QE for AFE



**Figure 1-2 Operating environment of the QE for AFE**

### 1.3 References

- R01UH0888 RA2A1 Group User’s Manual: Hardware
- R01AN5795 Application Note: RA2A1 Group Board Control Program for QE for AFE
- R20UT4580 Evaluation Kit for RA2A1 Microcontroller Group EK-RA2A1 User’s Manual

## 2. Preparation

The necessary preparations to use the QE for AFE are as follows.

- Installation of the QE for AFE
- Programming of the board control program for the QE for AFE
- Settings of the target board

### 2.1 Installation of the QE for AFE

The QE for AFE is provided in a zip package. The procedure how to use the QE for AFE is as follows.

(1) Unzip the zip file anywhere on your PC.

Unzip the zip file in a shallow folder hierarchy.

Note: Do not place it under the OS program folder (C:\Program Files).

(2) Double-click “\eclipse\qe-afe.exe” and start the QE for AFE.

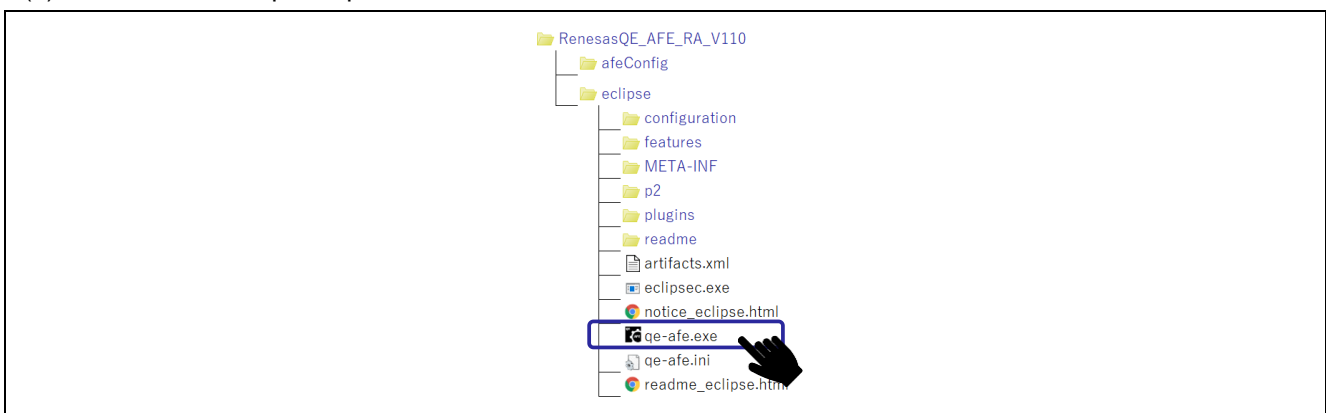


Figure 2-1 EXE file of the QE for AFE

(3) The license dialog is displayed when the QE for AFE is started for the first time. Check the contents of the license and select “Agree” or “Disagree”.

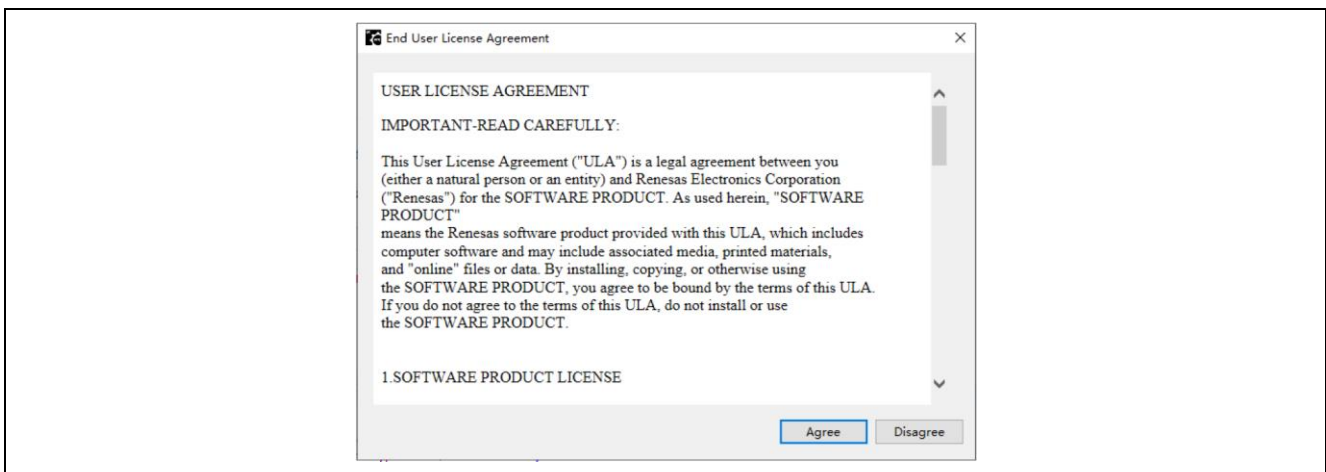


Figure 2-2 License agreement dialog

(4) If you select “Agree” in the above step, the QE for AFE will be launched and ready to use. If you select “Disagree”, the QE for AFE will not start and you will not be able to use it.

### 2.1.1 Update of the QE for AFE

If you want to update the QE for AFE, you can update using the same procedure as installation.

### 2.1.2 Uninstall of the QE for AFE

If you want to uninstall the QE for AFE, delete the folder where you unzipped the zip file.

## 2.2 Programming of the board control program for the QE for AFE

For the method of programming the board control program to RA2A1 on the target board, please refer to the application note: "RA2A1 Group Board Control Program for the QE for AFE".

## 2.3 Settings of the target board

### 2.3.1 Set the operating mode to "Single-chip mode"

Set "J8" jumper pin on the target board to "INTERNAL FLASH".



Figure 2-3 "INTERNAL FLASH" mode setting

### 2.3.2 Reference voltage pin connection setting when using ADC16

The reference voltage pins for ADC16 is as follows.

- Positive reference voltage: Reference voltage pin (VREFH0) or Internal reference voltage (VREFADC)
- Negative reference voltage: Reference ground pin (VREFL0)

On the EK-RA2A1 board, VREFH0 and VREFL0 are open. Therefore, when using ADC16, it is necessary to supply reference voltage to these pins.

Pin 34 (VREFL0) and pin 36 (AVSS0) of "J2" on EK-RA2A1 board are adjacent pins, and can be easily connected using jumper as shown below.

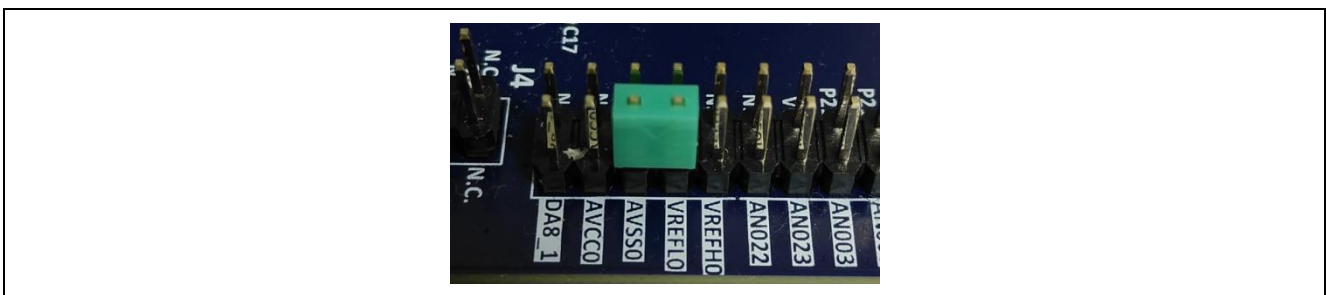


Figure 2-4 VREFL0 connection example when using ADC16

### 3. Connection

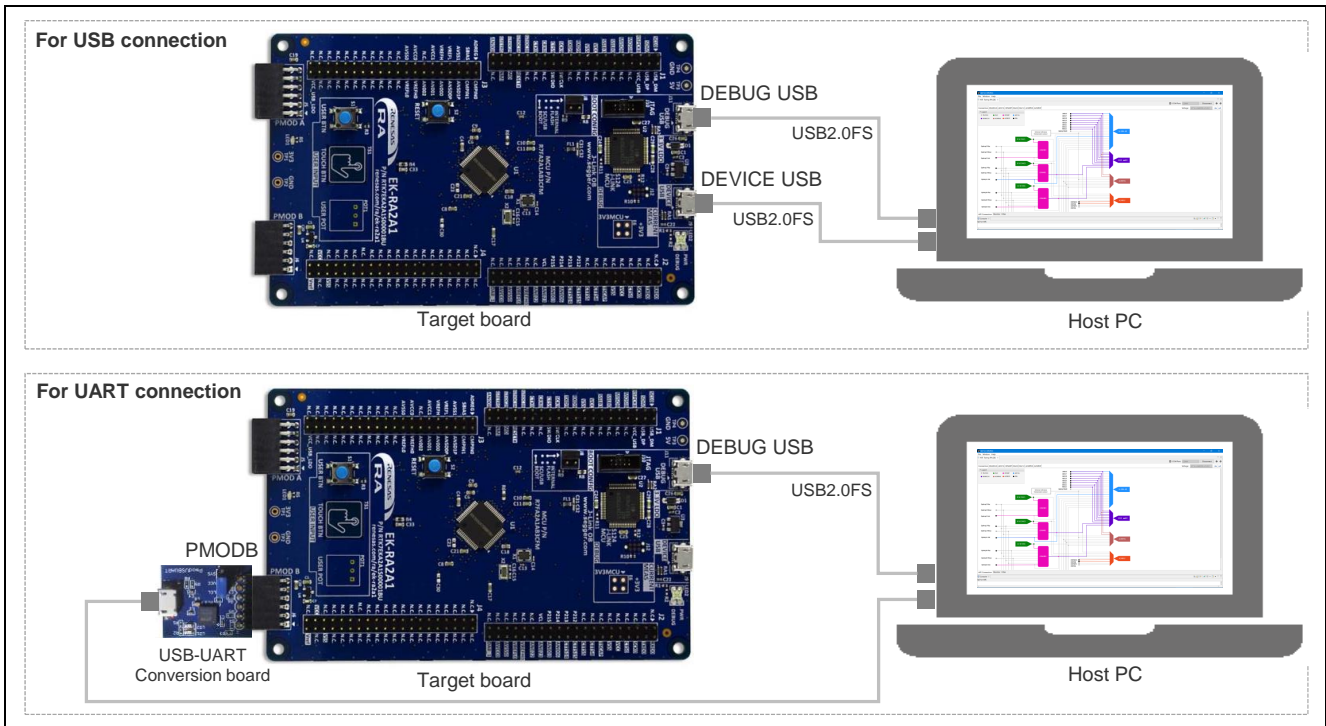
Before connecting the host PC and the target board, refer to “2. Preparation” to complete the preparation.

Follow the procedure below to establish a connection in order to operate RA2A1 on the target board from the QE for AFE.

- (1) Connect the host PC and the target board with a USB cable.

The communication between the host PC and the target board can be selected from USB PCDC or SCI UART. “Board control program for the QE for AFE” corresponding to each communication is included in the QE for AFE package. Either communication to be used is depends on the “board control program for QE for AFE” which is programmed to RA2A1 on the target board.

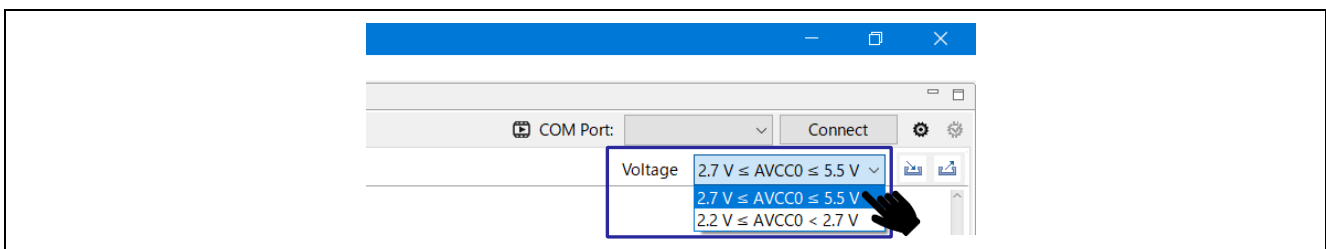
Figure 3-1 shows the connection diagram between the host PC and the target board.



**Figure 3-1 System connection diagram**

For details on the target board, refer to “RA2A1 Group Evaluation Kit for RA2A1 Microcontroller Group EK-RA2A1 User’s Manual”.

- (2) Start the QE for AFE  
Start the QE for AFE on host PC.
- (3) Select of AVCC0 voltage  
Select the voltage range to provide AVCC0.



**Figure 3-2 Selection of AVCC0 voltage**



(4) COM port selection and connection with the target board

Confirm “COM Port” of “USB Serial Device” from Device Manager on host PC, and set it in the QE for AFE. After setting of “COM Port”, connect the QE for AFE to the target board.

Figure 3-3 shows the selection of the “COM Port” and connection control with the target board.

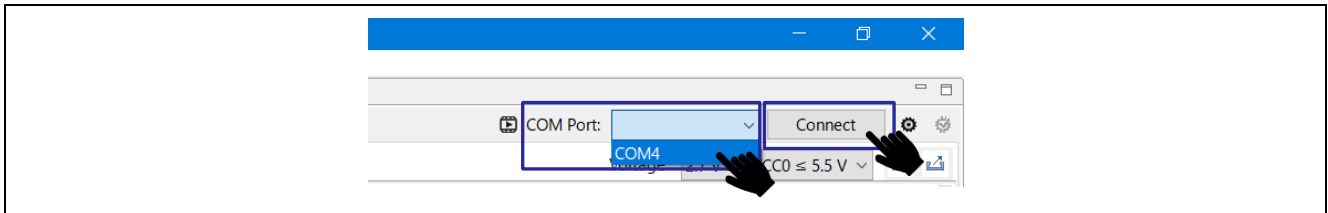


Figure 3-3 COM port selection and connection control

### 3.1 Precautions when connecting UART

#### 3.1.1 Do not use power supply function of USB-UART adapter

Some USB-UART adapter can supply 3.3V. To prevent supplying different voltage to the EK-RA2A1 board from different power source, do not use 3.3V supply function from USB-UART adapter.

#### 3.1.2 Baud-rate changing procedure

After reset the target board, connect with the default baud-rate of 1,000,000bps. Once connected, the baud-rate can be changed by clicking the icon below.

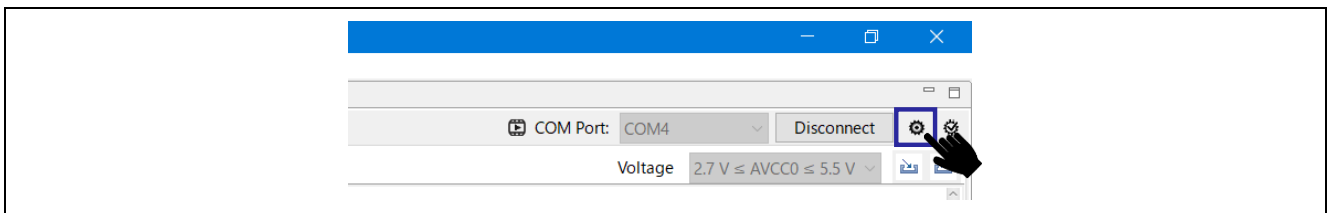


Figure 3-4 UART baud-rate setting

The baud-rate can be selected from the pull-down menu, or can be entered directly as shown below.

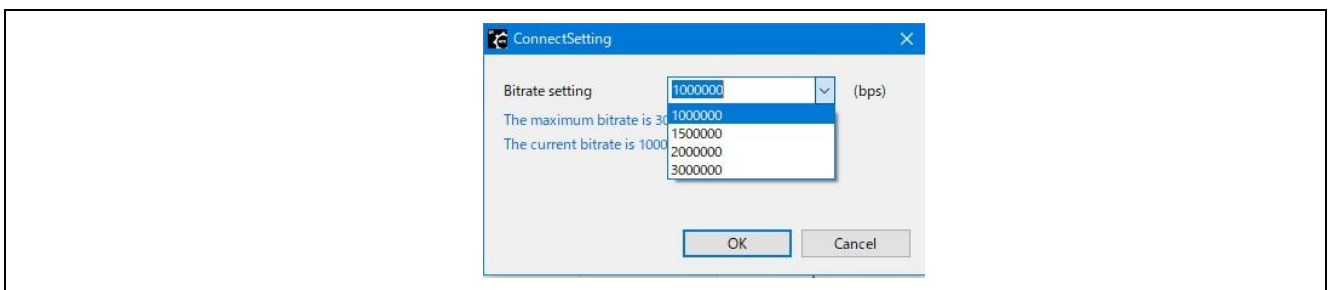


Figure 3-5 UART baud-rate selection

### 4. Evaluation Examples

This application note provides a register setting file that can be imported into the QE for AFE. This chapter describes the procedure to import the register setting file and evaluation. Table 4-1 lists the register setting files.

The detailed evaluation procedure is explained in “4.1 Evaluation Procedure”, and the setting example of each function is show in “4.2 SDADC24 Evaluation Example” and later.

**Table 4-1 List of the register setting file**

Register setting file name	Descriptions	Reference
qe_afe_sample_dac8_adc16.2a1	The output of DAC8 is used for the input of ADC16 via OPAMP for A/D conversion. This register setting file is for checking the operation of the QE for AFE. You can check the operation without using external analog signal.	4.1
qe_afe_sample_sdadc24.2a1	The analog signals from AN022 pin and AN023 pin are used for SDADC24 A/D conversion.	4.2
qe_afe_sample_adc16.2a1	The analog signal from AN008 pin is used for ADC16 A/D conversion.	4.3
qe_afe_sample_acmphs.2a1	ACMPHS comparator compares the analog signal from AN000 pin with the DAC12 output voltage.	4.4
qe_afe_sample_acmplp.2a1	Two ACMLP comparators operate as “window comparator” which compare the analog signal from CMPIN1 pin with the two DAC8 output voltages.	4.5

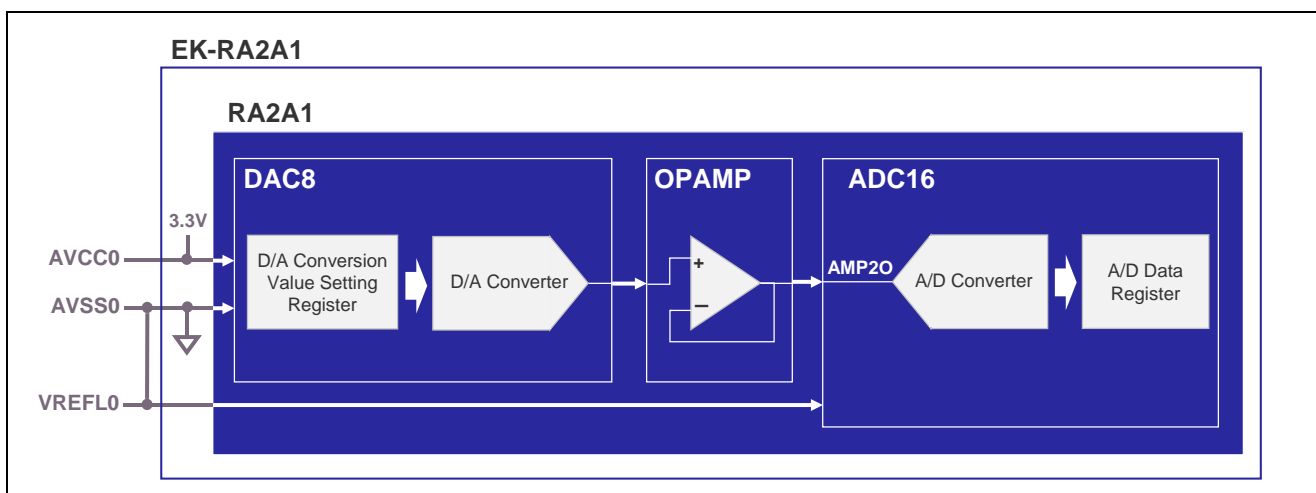
#### 4.1 Evaluation Procedure

This chapter describes the evaluation procedure when the output of DAC8 is used for the input of ADC16 via OPAMP for A/D conversion.

- Register setting file: qe\_afe\_sample\_dac8\_adc16.2a1

In this example, it is not necessary to supply reference voltage and input signal from outside of the target board. Therefore, it is easy to check how to use the QE for AFE.

USB PCDC is used for the communication between the QE for AFE and the target board.



**Figure 4-1 Evaluation Procedure: AFE connection**

### 4.1.1 Preparation

Follow “2 Preparation” to prepare for using the QE for AFE.

- Installation of the QE for AFE
- Programming of the board control program for the QE for AFE
- Settings of the target board
  - Set “J8” jumper pin on the target board to “INTERNAL FLASH”.
  - Short “VREFLO” pin and “AVSS0” pin to use ADC16.

### 4.1.2 Connect host PC to the target board

Connect host PC and the target board as shown below.

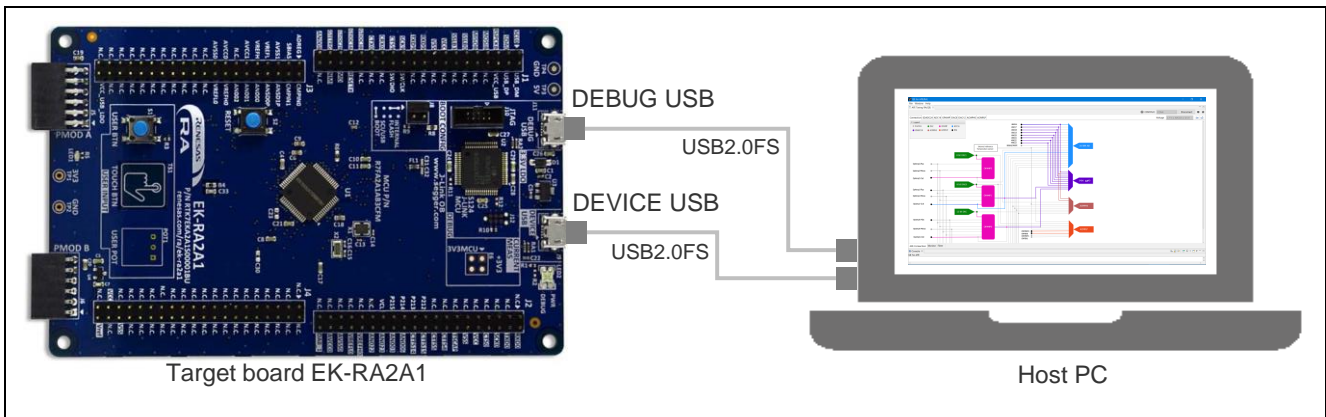


Figure 4-2 Evaluation Procedure: Connect host PC and the target board

### 4.1.3 Connect the QE for AFE and the target board

Start the QE for AFE.

3.3V is supplied to AVCC0 of the target board. Select the voltage range to provide AVCC0 as shown below.

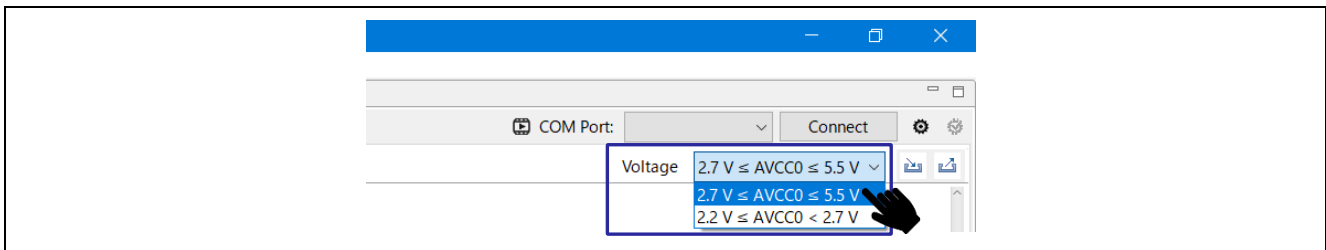


Figure 4-3 Evaluation Procedure: Selection of AVCC0 voltage

Select “COM Port”, and click “Connect”.

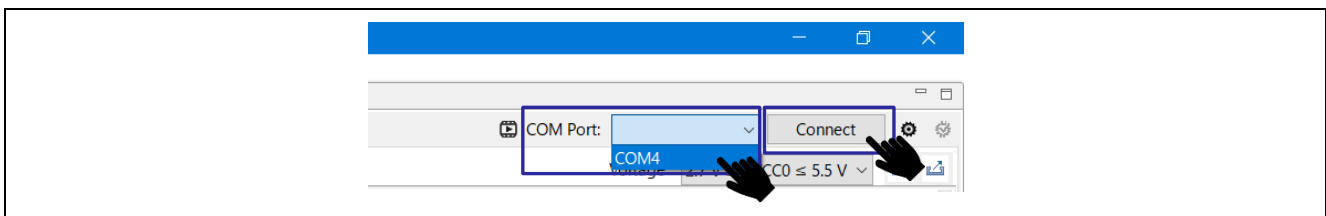


Figure 4-4 Evaluation Procedure: COM port selection and connection control

In the QE for AFE console, verify that the connection was successful. If the connection is successful, the register value is also automatically written to the target board.

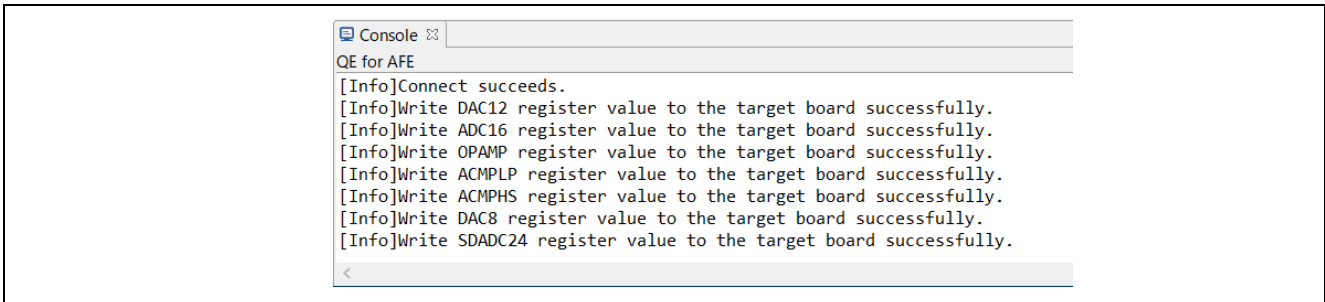


Figure 4-5 Evaluation Procedure: Successful connection

#### 4.1.4 Import the register setting file

Select "AFE Connection" tab, and display the setting.



Figure 4-6 Evaluation Procedure: AFE Connection tab

Click the icon as shown below, import the register setting file.

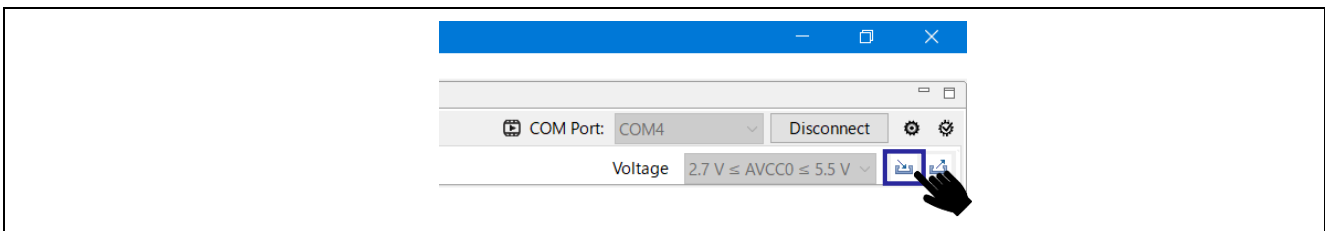


Figure 4-7 Evaluation Procedure: Import icon

Once select the register setting file, the window as shown below will be displayed. Make sure all functions are checked, and click "OK".

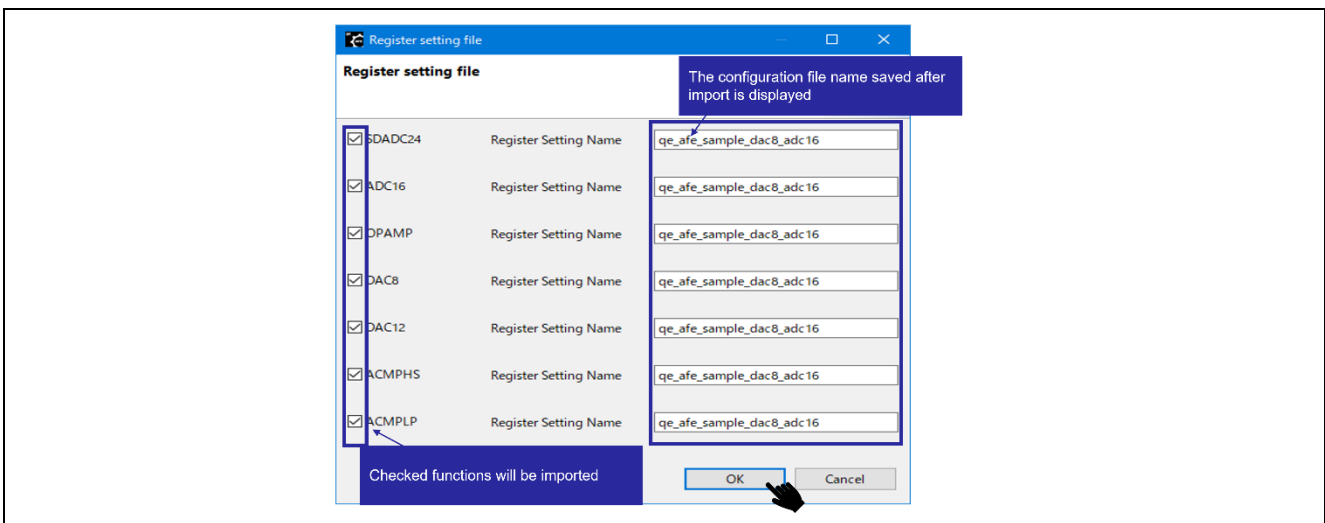


Figure 4-8 Evaluation Procedure: Selection of the register setting file

### 4.1.5 Configuration of DAC8

In the register setting file, DAC8 Channel1 is used to perform D/A conversion of 0x73 to generate an analog signal (about 1.5V).

Select “DAC8” tab, and display the setting.

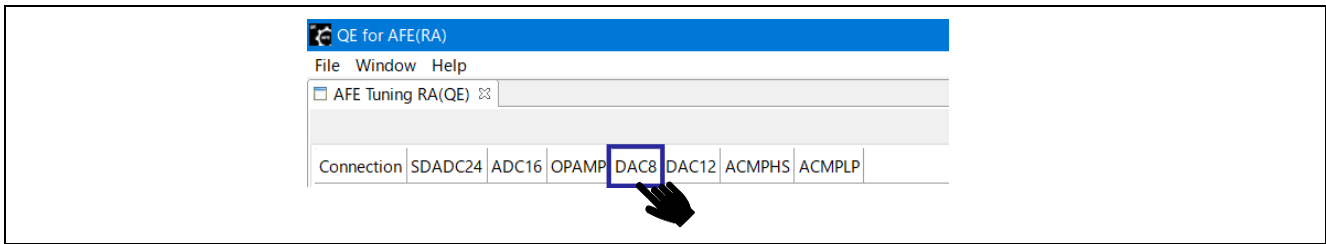


Figure 4-9 Evaluation Procedure; DAC8 tab

DAC8 is configured as shown below.

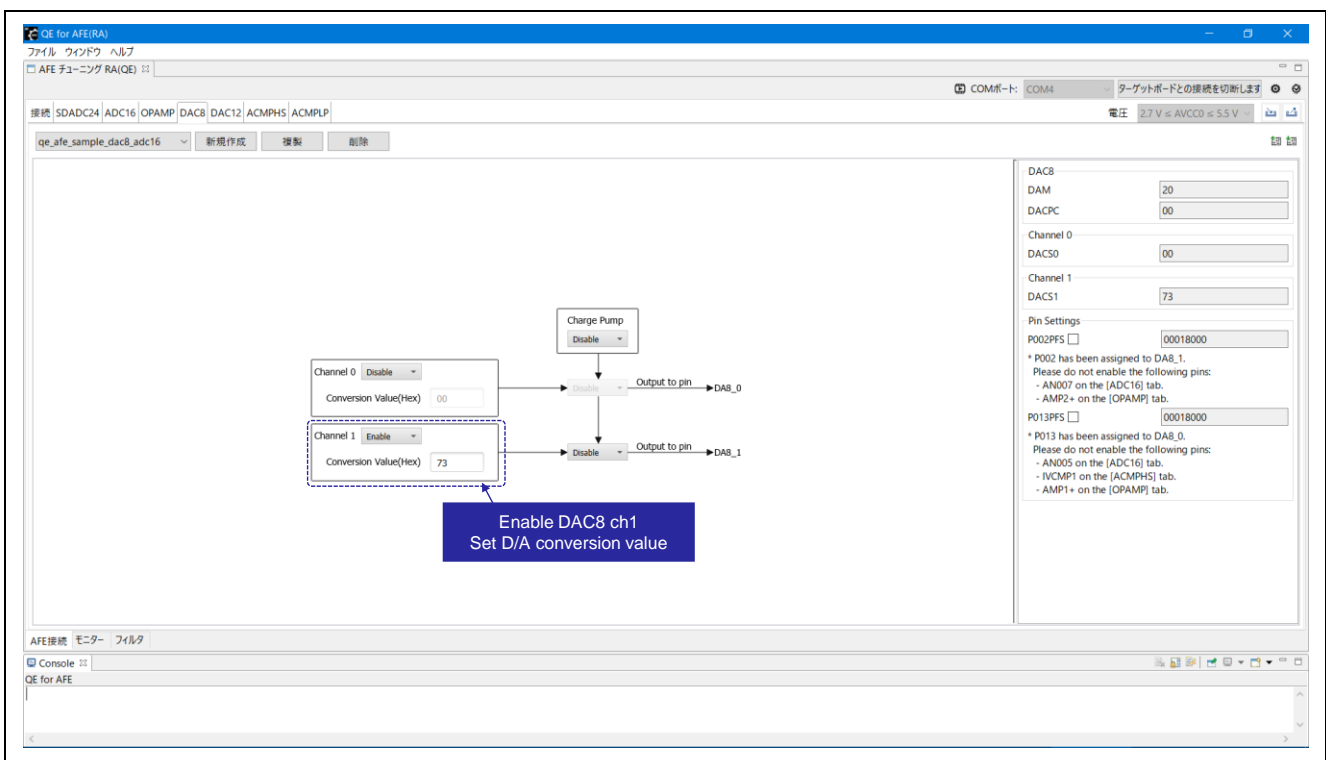


Figure 4-10 Evaluation Procedure: Configuration of DAC8

### 4.1.6 Configuration of OPAMP

In the register setting file, OPAMP2 is used and select the output from DAC8 channel 1 as input signal. Select “OPAMP” tab, and display the setting.

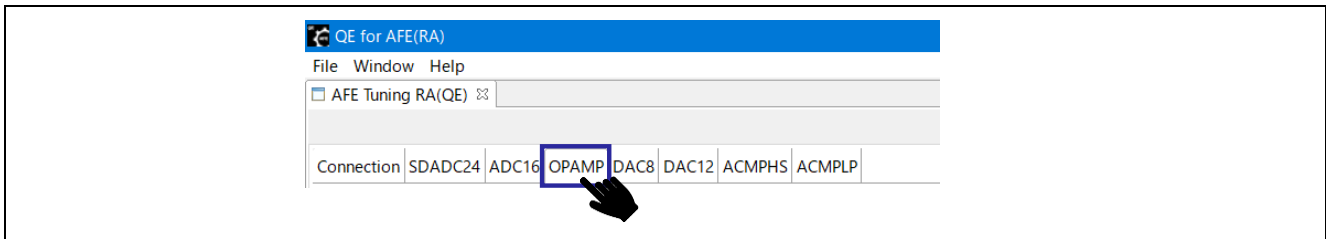


Figure 4-11 Evaluation Procedure: OPAMP tab

OPAMP is configured as shown below.

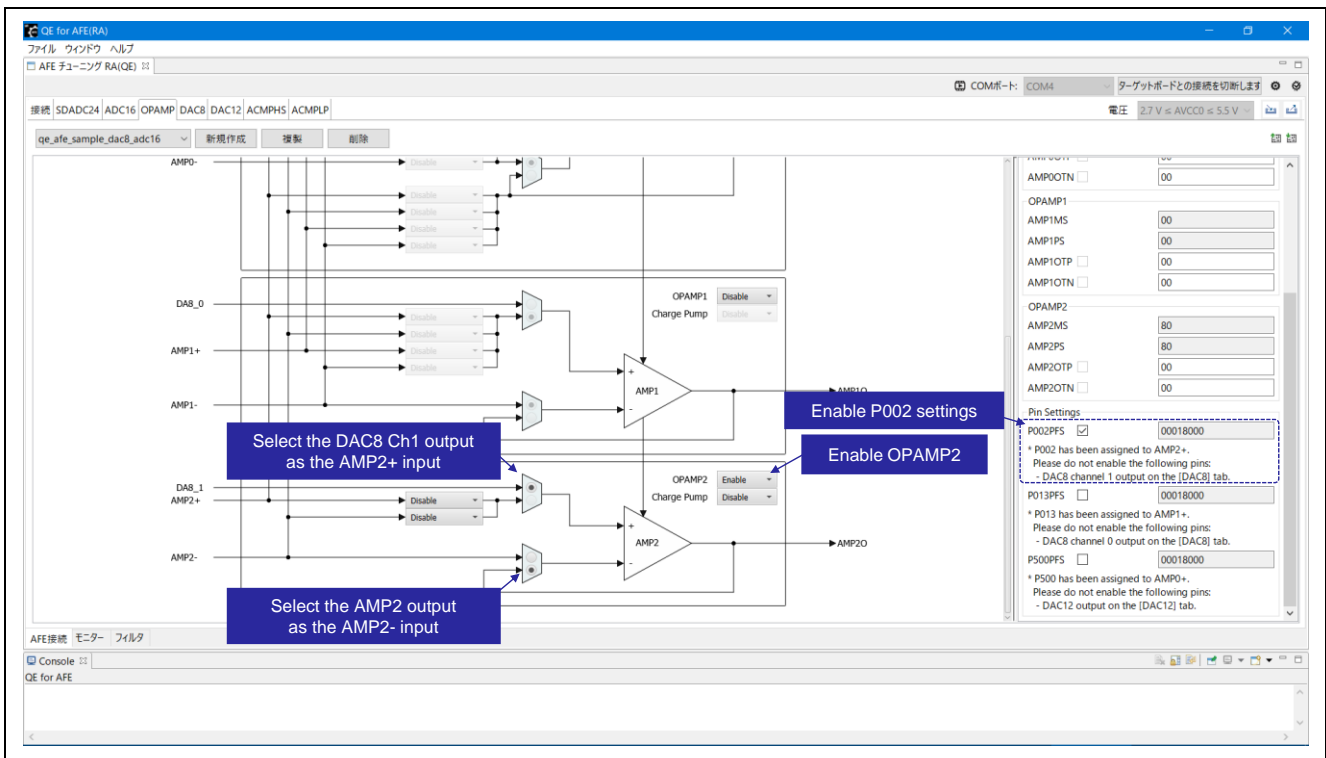


Figure 4-12 Evaluation Procedure: Configuration of OPAMP

### 4.1.7 Configuration of ADC16

In the register setting file, ADC16 sets the OPAMP2 output to the input signal, and set the A/D conversion cycle to 0.40625 $\mu$ s.

Select “ADC16” tab as shown below, display the setting.

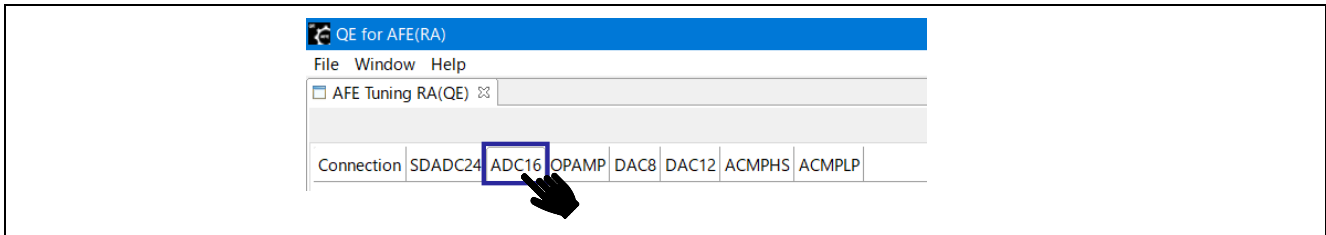


Figure 4-13 Evaluation Procedure: ADC16 tab

ADC16 is configured as shown below.

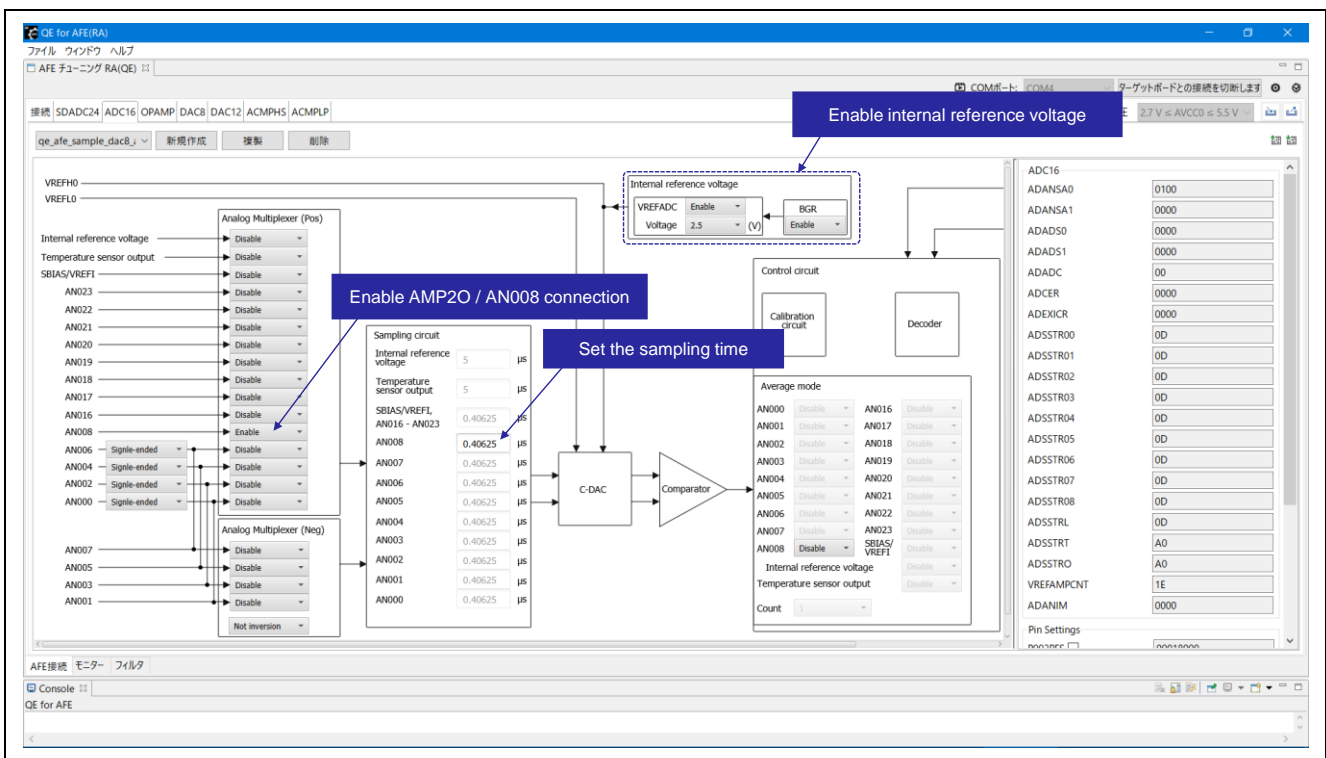


Figure 4-14 Evaluation Procedure: Configuration of ADC16

### 4.1.8 Confirmation of connection

Select the "Connection" tab as shown below, and confirm the connection.

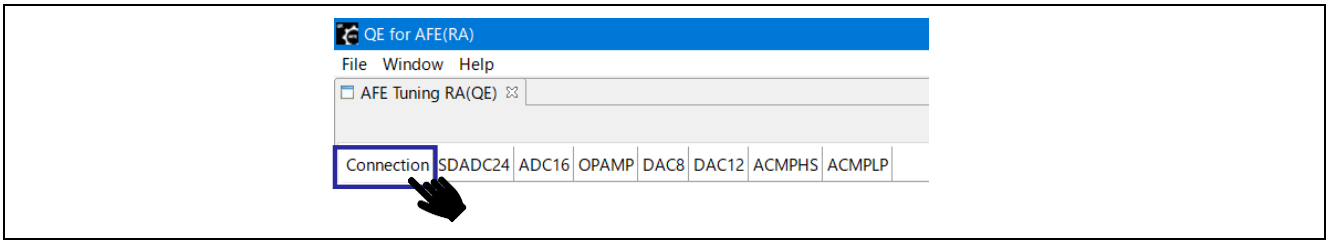


Figure 4-15 Evaluation Procedure: Connection tab

The settings of DAC8, OPAMP, and ADC16 are reflected in the connection diagram.

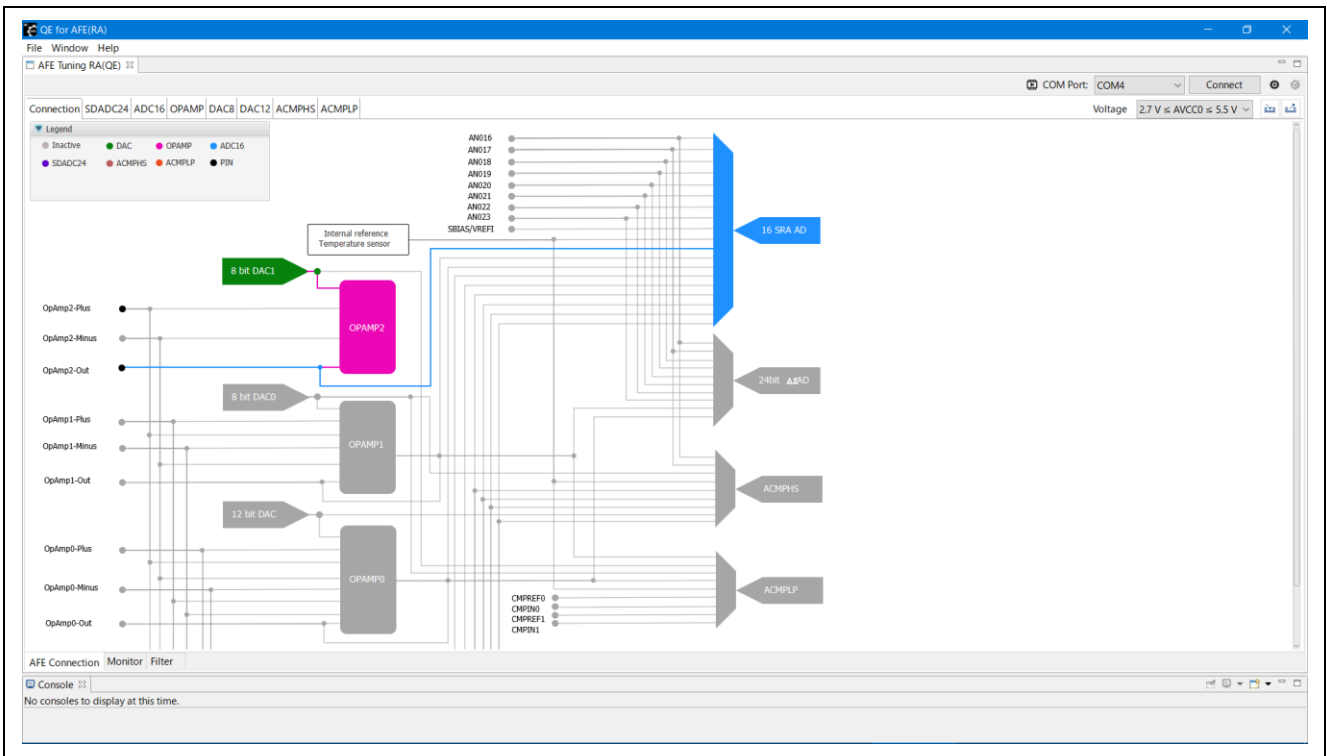


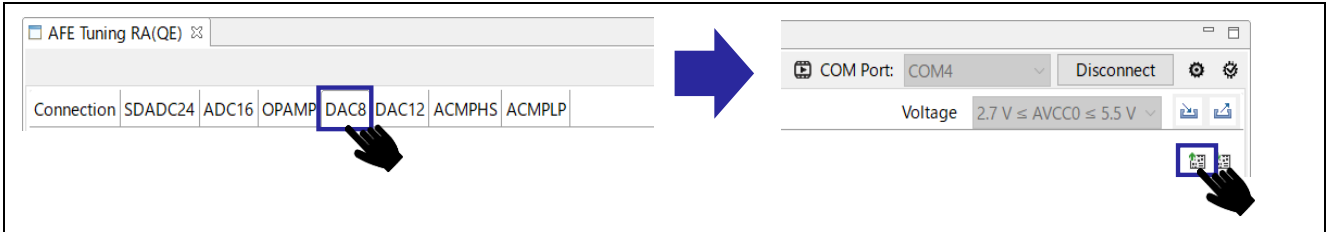
Figure 4-16 Evaluation Procedure: Connection diagram



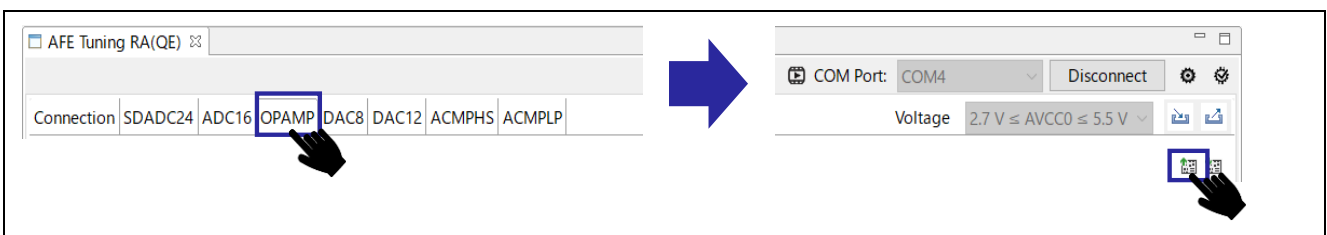
**4.1.9 Reflection to RA2A1**

For each setting of “DAC8”, “OPAMP”, and “ADC16”, once the icon as shown below is clicked, the register setting value of each function will be reflected to RA2A1 on the target board.

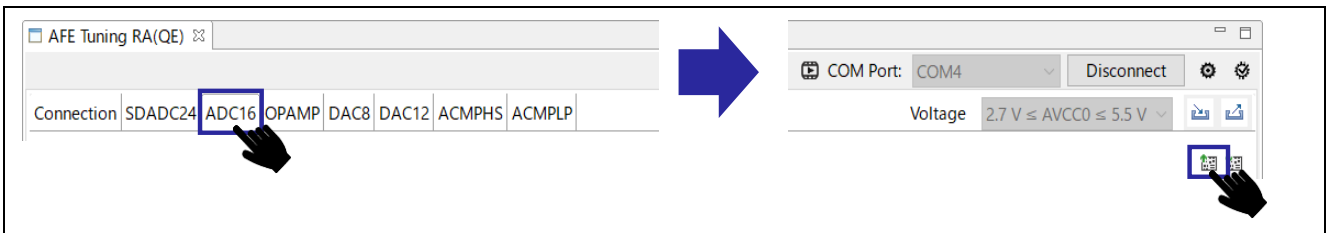
If the value other than the initial value has been set to the register of the functions other than these three functions before importing the register setting file, make sure to write to the functions for which the value other than the initial value has been set, in the same way.



**Figure 4-17 Evaluation Procedure: Reflection of DAC8 register value**

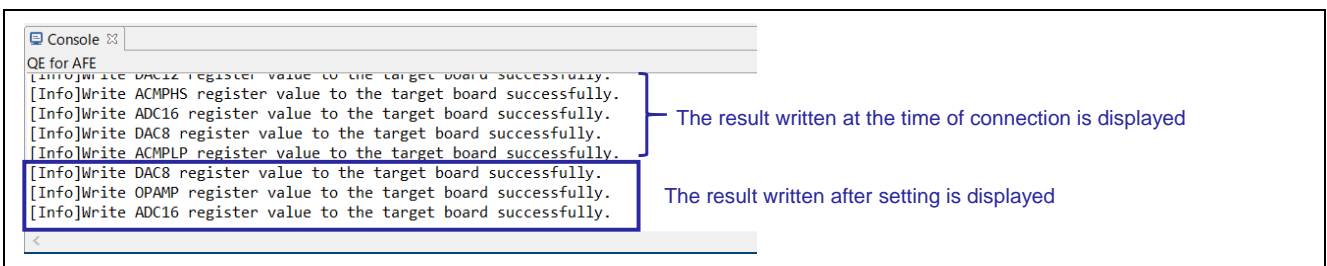


**Figure 4-18 Evaluation Procedure: Reflection of OPAMP register value**



**Figure 4-19 Evaluation Procedure: Reflection of ADC16 register value**

In the QE for AFE console, verify that the register values of all related functions are reflected to RA2A1.



**Figure 4-20 Evaluation Procedure: Successfully reflected**

### 4.1.10 Start tuning

Select "Monitor" tab, and switch the display.

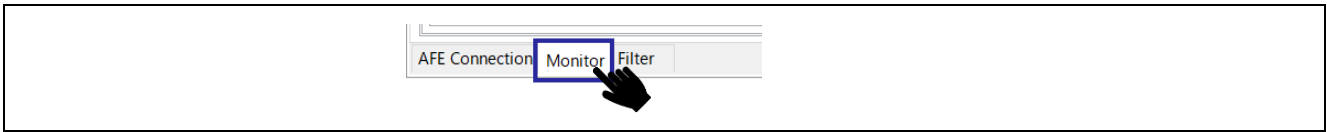


Figure 4-21 Evaluation Procedure: Monitor tab

Select ADC16 to be monitored from the pull-down menu as shown below, and select "Auto" mode. The mode can only be selected if ADC16 is selected for monitoring.

The selection of monitoring function is made while AFE tuning is stopped.

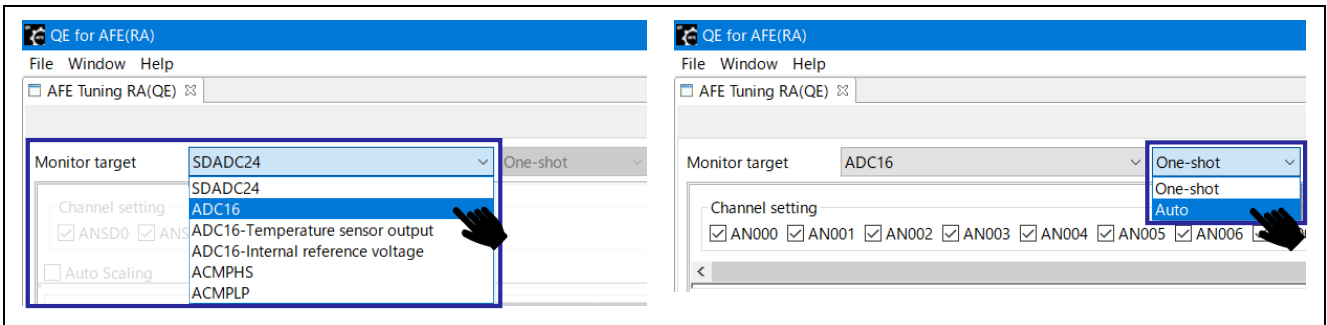


Figure 4-22 Evaluation Procedure: Selection of monitoring function

Click the icon as shown below, start AFE tuning.

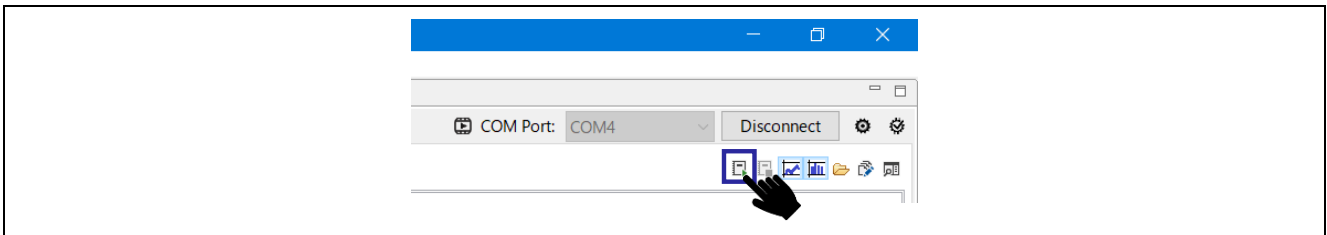


Figure 4-23 Evaluation Procedure: Start AFE tuning

In the QE for AFE console, verify that the AFE tuning is started.

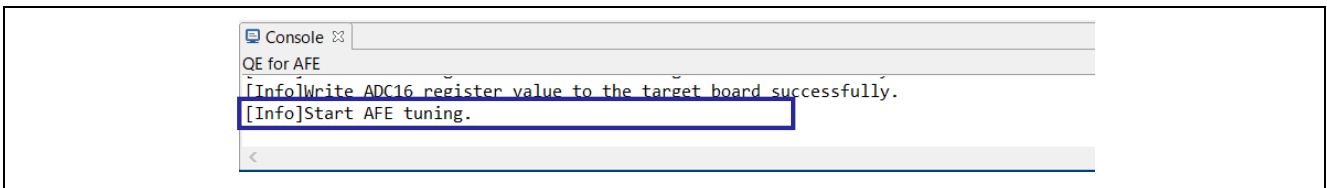


Figure 4-24 Evaluation Procedure: Tuning is started

4.1.11 Display of the graph

In the initial state, the waveform is displayed on the left side of the screen and the histogram is displayed on the right screen. If the waveform is not displayed, click the icon below to display the waveform.

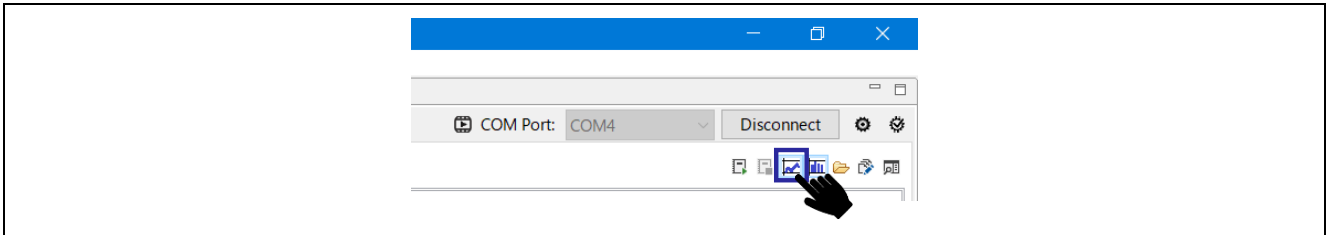


Figure 4-25 Evaluation Procedure: The icon to display the waveform

If the histogram is not displayed, click the icon below to display the histogram.

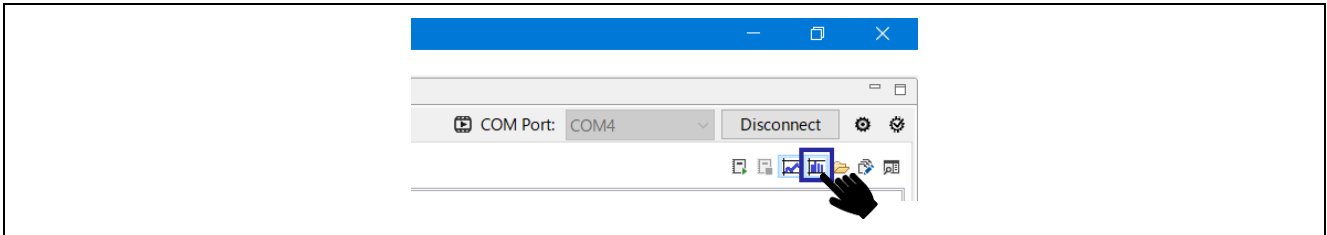


Figure 4-26 Evaluation Procedure: The icon to display the histogram

The value of the ADC16 conversion result register is displayed graphically. It is possible to change both X-axis and Y-axis range of the graph as shown below.

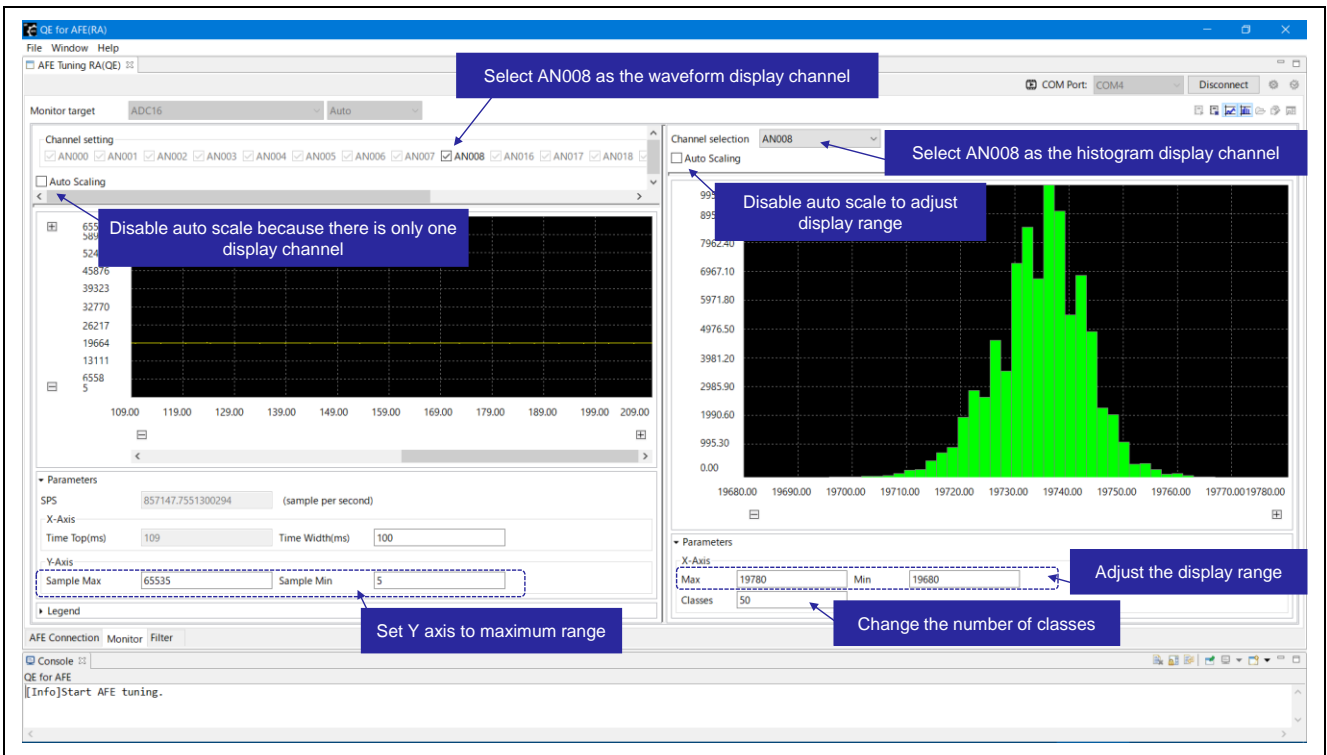


Figure 4-27 Evaluation Procedure: Graph settings

### 4.2 Evaluation example of SDADC24

This chapter shows an example of acquiring the result of SDADC24 A/D conversion of the input signal from AN022 pin and AN023 pin as shown in Figure 4-28.

For details of the evaluation procedure, refer to “4.1 Evaluation Procedure”.

- Register setting file: qe\_afe\_sample\_sdadc24.2a1

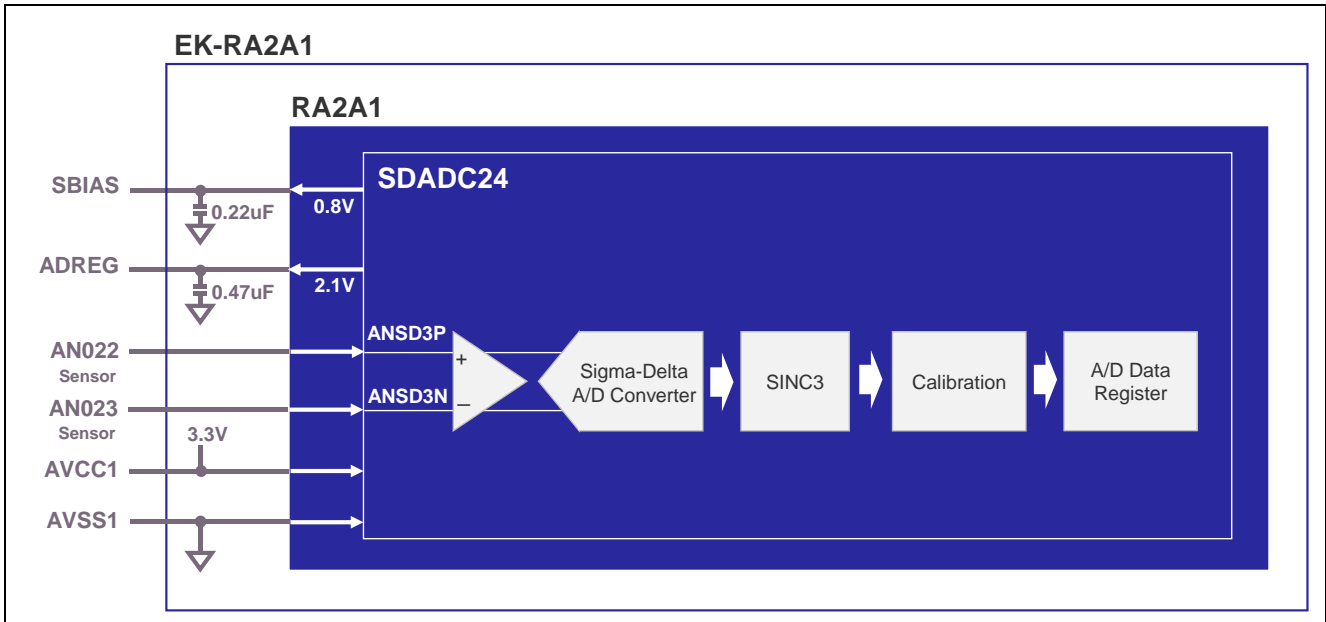


Figure 4-28 Evaluation example of SDADC24: AFE connection

Once the register setting file is imported, the settings will become as shown in Figure 4-29 and Figure 4-30.

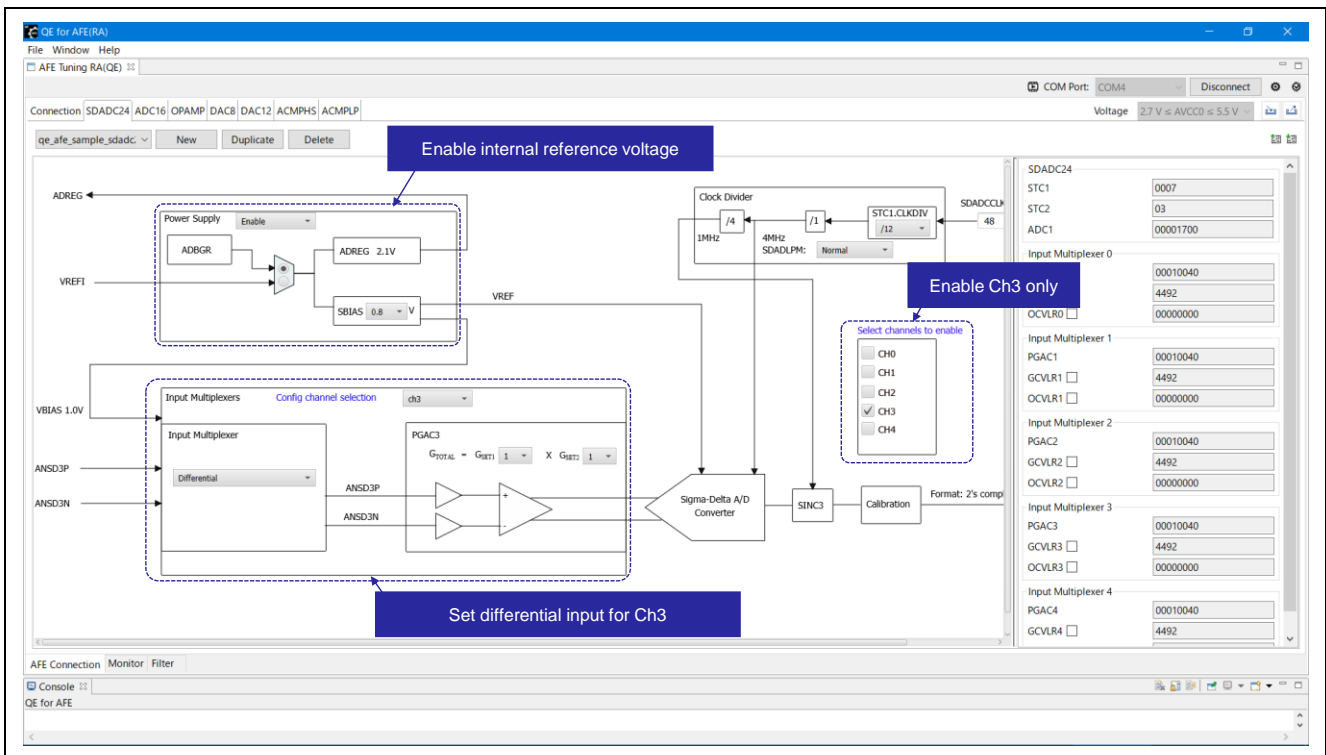


Figure 4-29 Evaluation example of SDADC24: SDADC24 settings

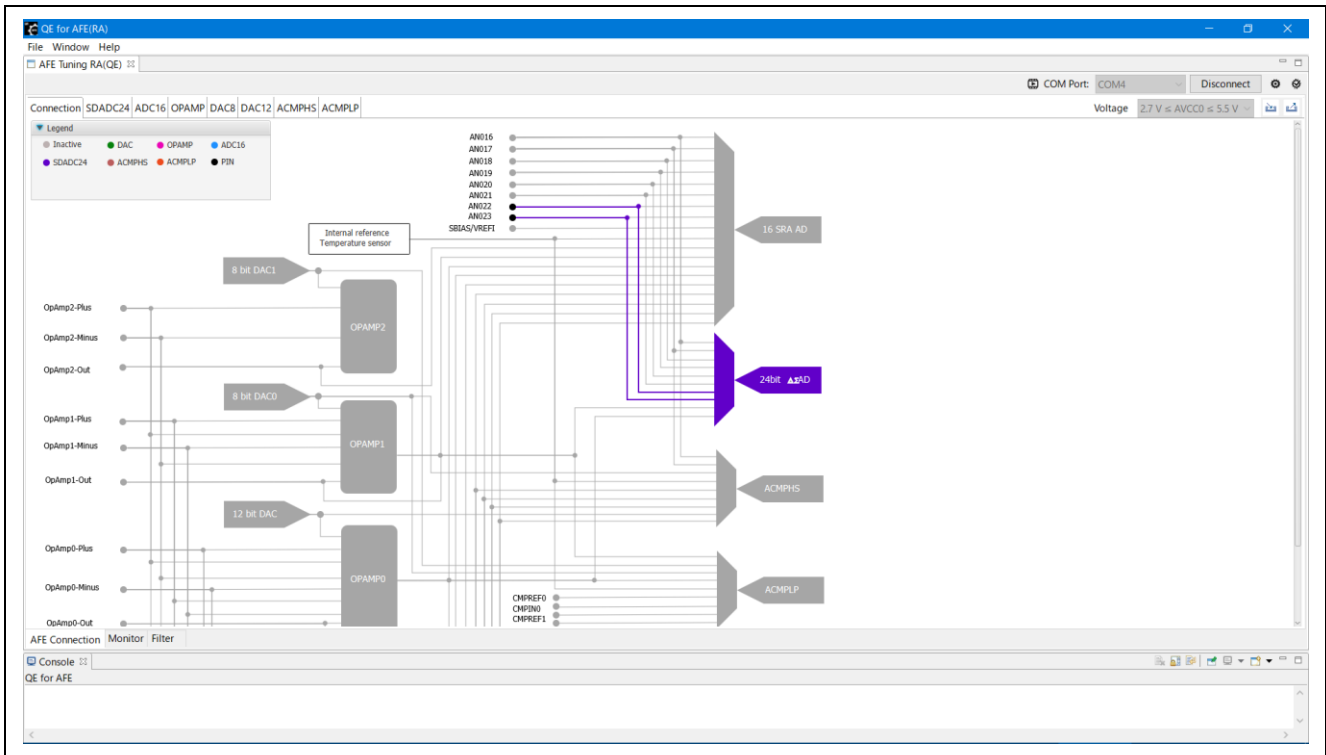


Figure 4-30 Evaluation example of SDADC24: Connection diagram

The A/D conversion result when the analog signals are input from the AN022 pin and AN023 pin is displayed as a graph as shown below.

Figure 4-31 shows only the waveform.

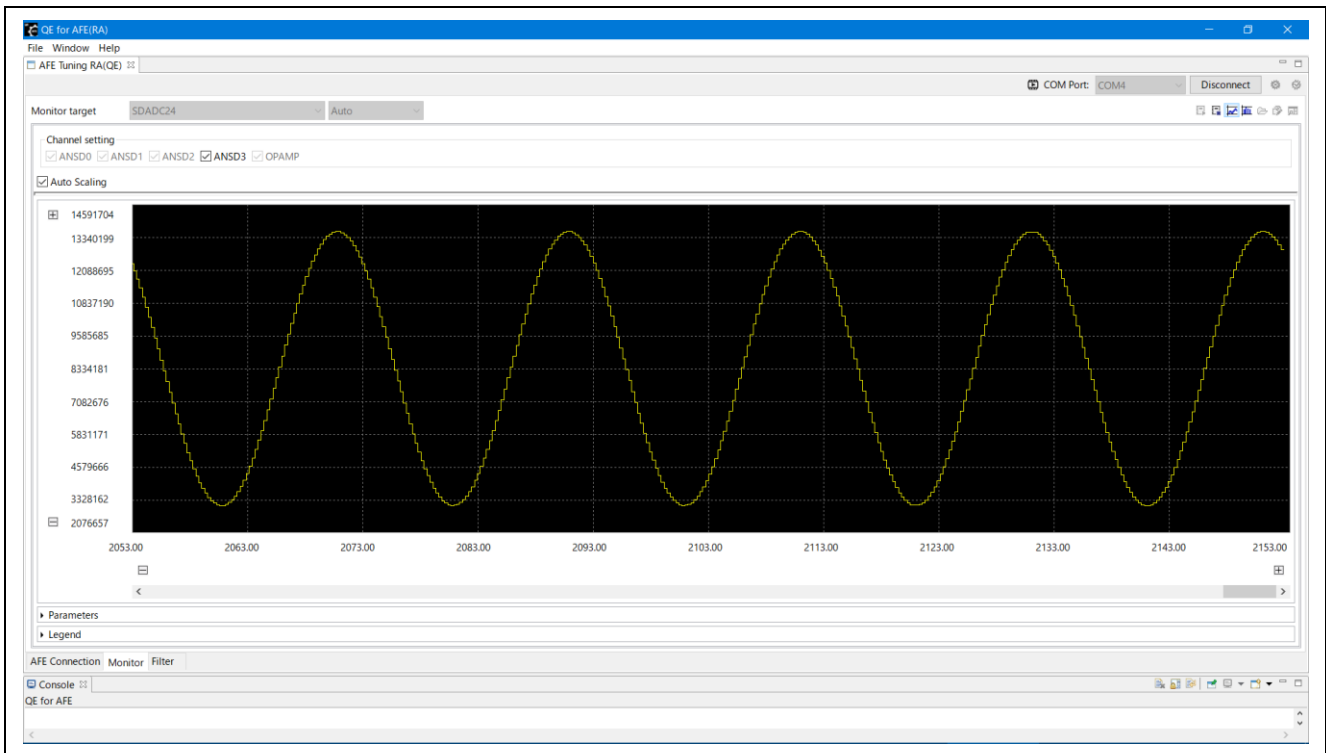


Figure 4-31 Evaluation example of SDADC24: Display of the waveform

### 4.3 Evaluation example of ADC16

This chapter shows an example of acquiring the result of ADC16 A/D conversion of the input signal from AN008 pin as shown in Figure 4-32.

For details of the evaluation procedure, refer to “4.1 Evaluation Procedure”.

- Register setting file: qe\_afe\_sample\_adc16.2a1

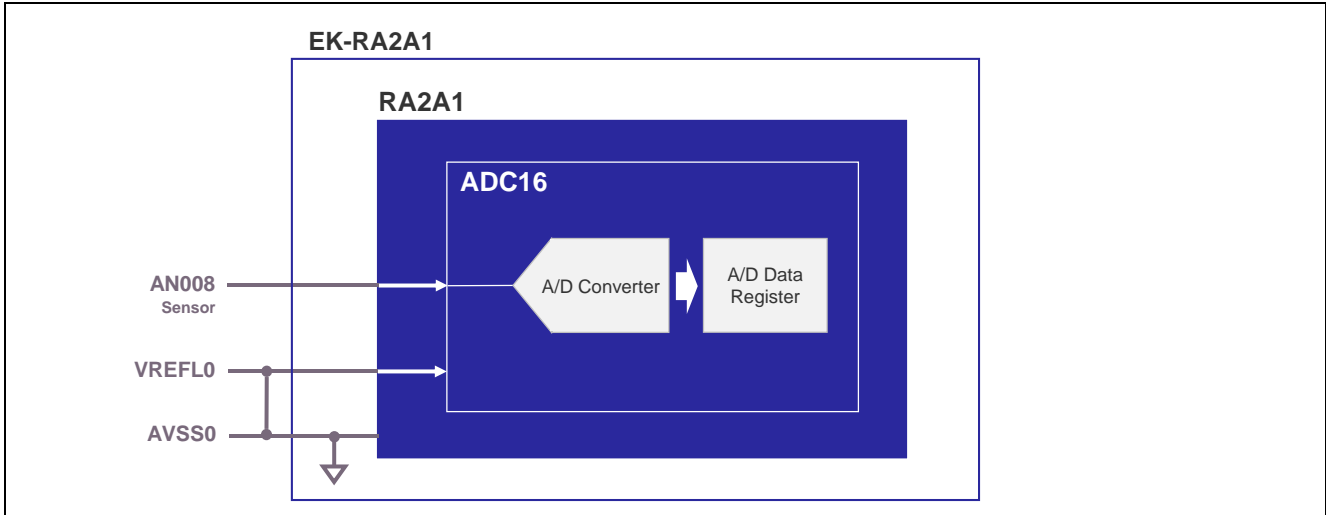


Figure 4-32 Evaluation example of ADC16: AFE connection

Once the register setting file is imported, the settings will become as shown in Figure 4-33 and Figure 4-34.

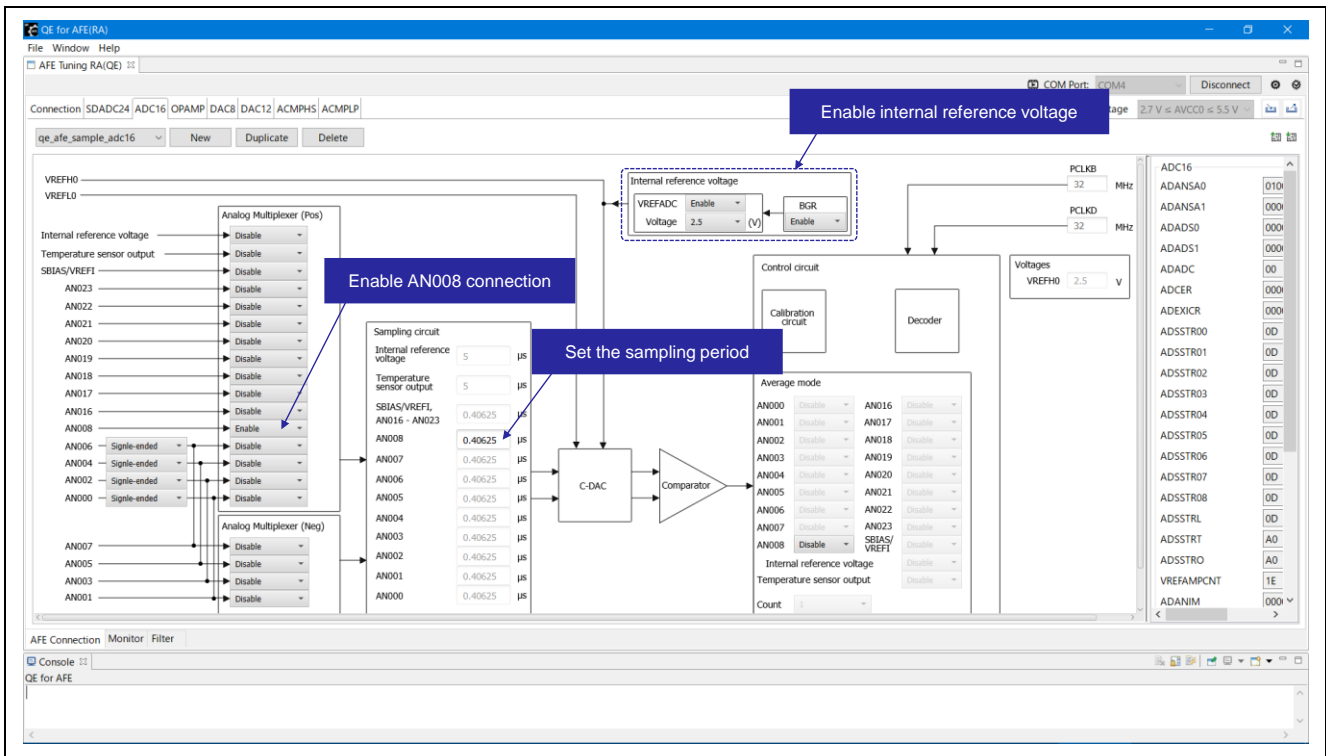


Figure 4-33 Evaluation example of ADC16: ADC16 settings

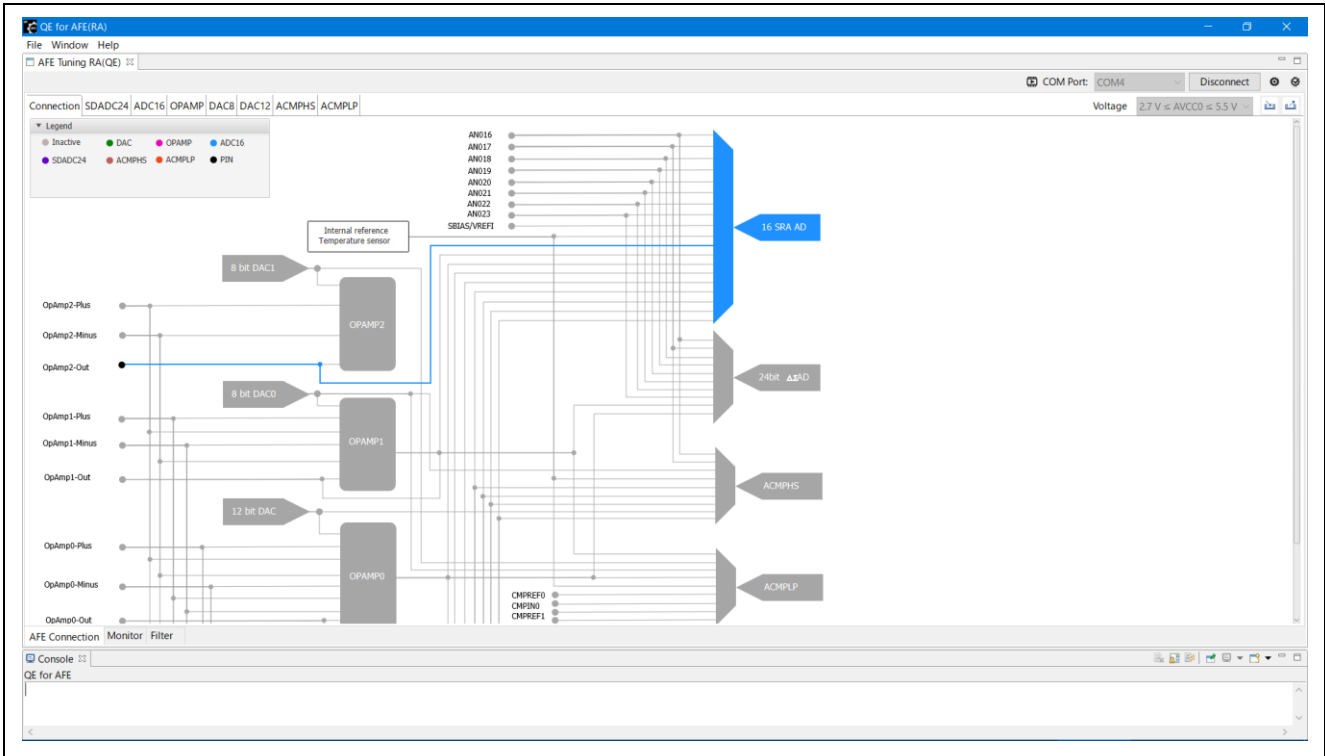


Figure 4-34 Evaluation example of ADC16: Connection diagram

The A/D conversion result when the constant voltage signal is input from the AN008 pin is displayed as a graph as shown below.

Figure 4-35 shows the waveform and the histogram.

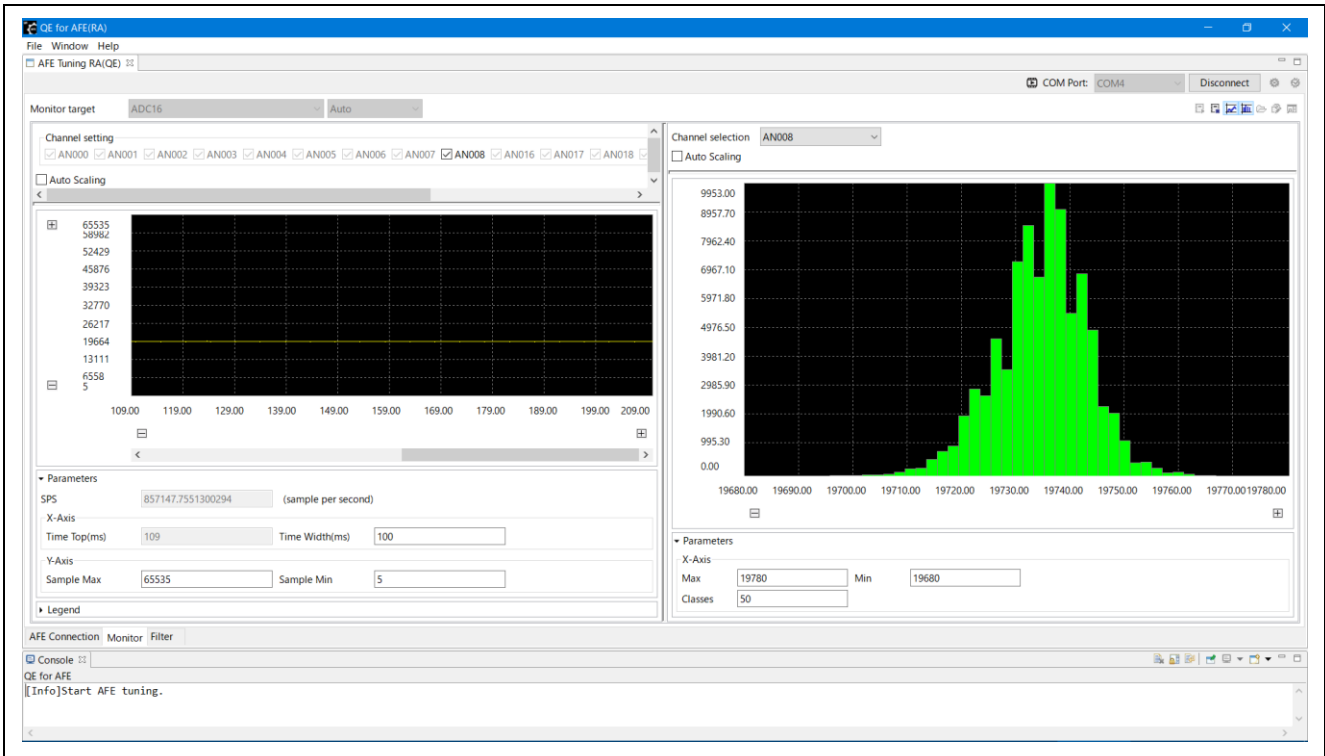


Figure 4-35 Evaluation example of ADC16: Display of the graph

### 4.4 Evaluation example of ACOMPNS

This chapter shows an example of ACOMPNS operation as a comparator by comparing the analog signal input from AN000 pin with DAC12 output as shown in Figure 4-36.

For details of the evaluation procedure, refer to “4.1 Evaluation Procedure”.

- Register setting file: qe\_afe\_sample\_acmpns.2a1

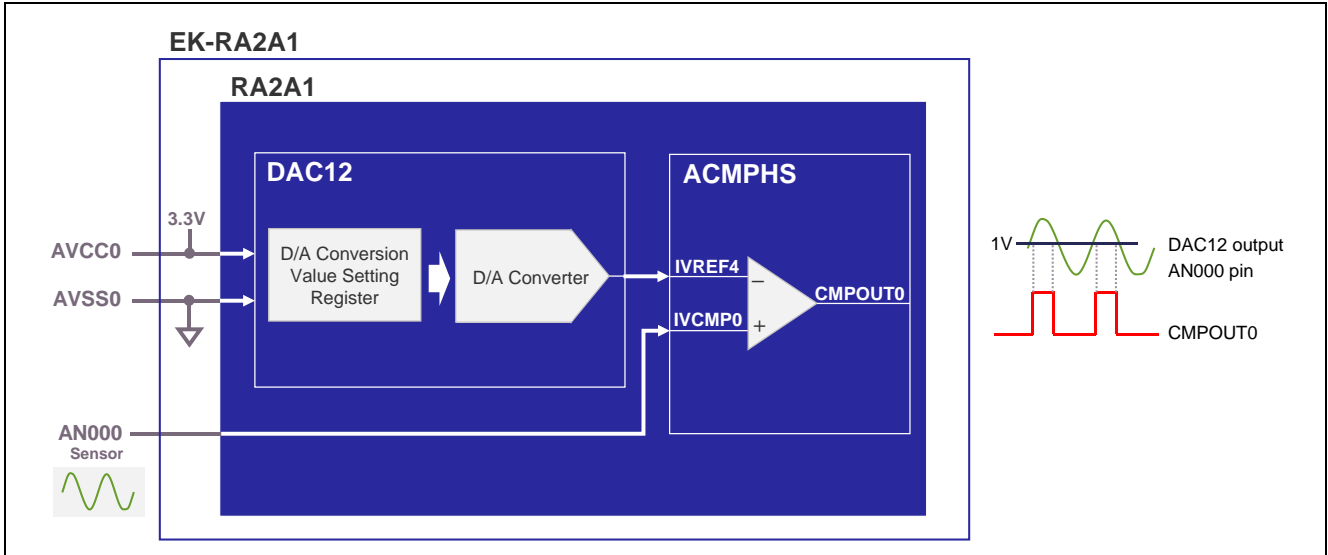


Figure 4-36 Evaluation example of ACOMPNS: AFE connection

Once the register setting file is imported, the settings will become as shown in Figure 4-37, Figure 4-38, and Figure 4-39.

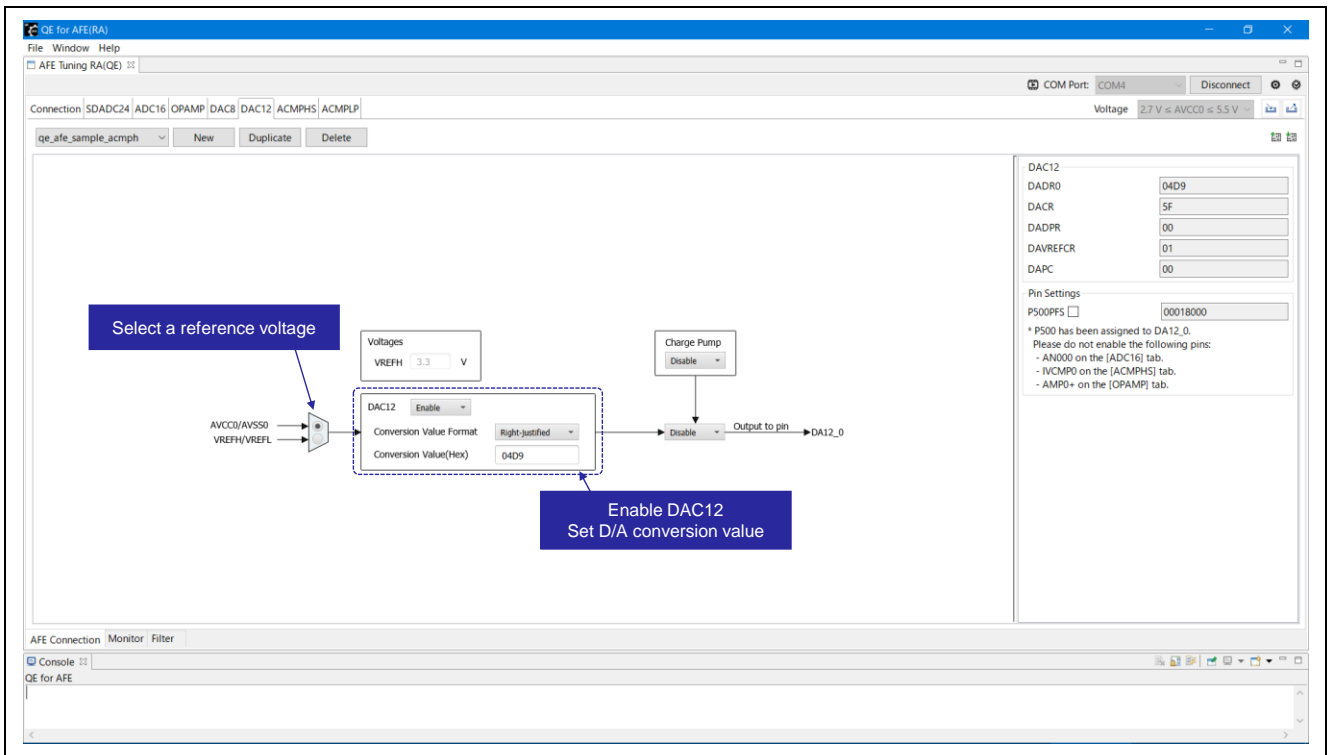


Figure 4-37 Evaluation example of ACOMPNS: DAC12 settings



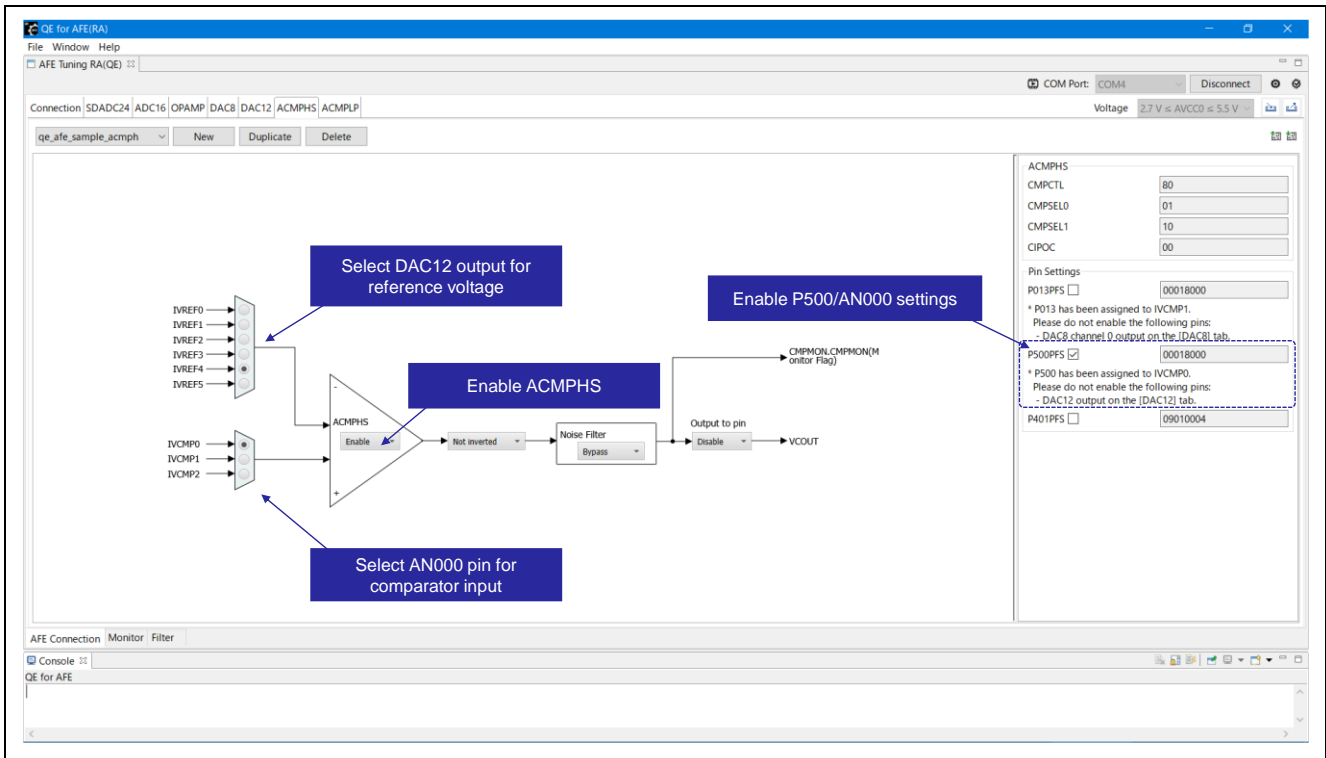


Figure 4-38 Evaluation example of ACMPHS: ACMPHS settings

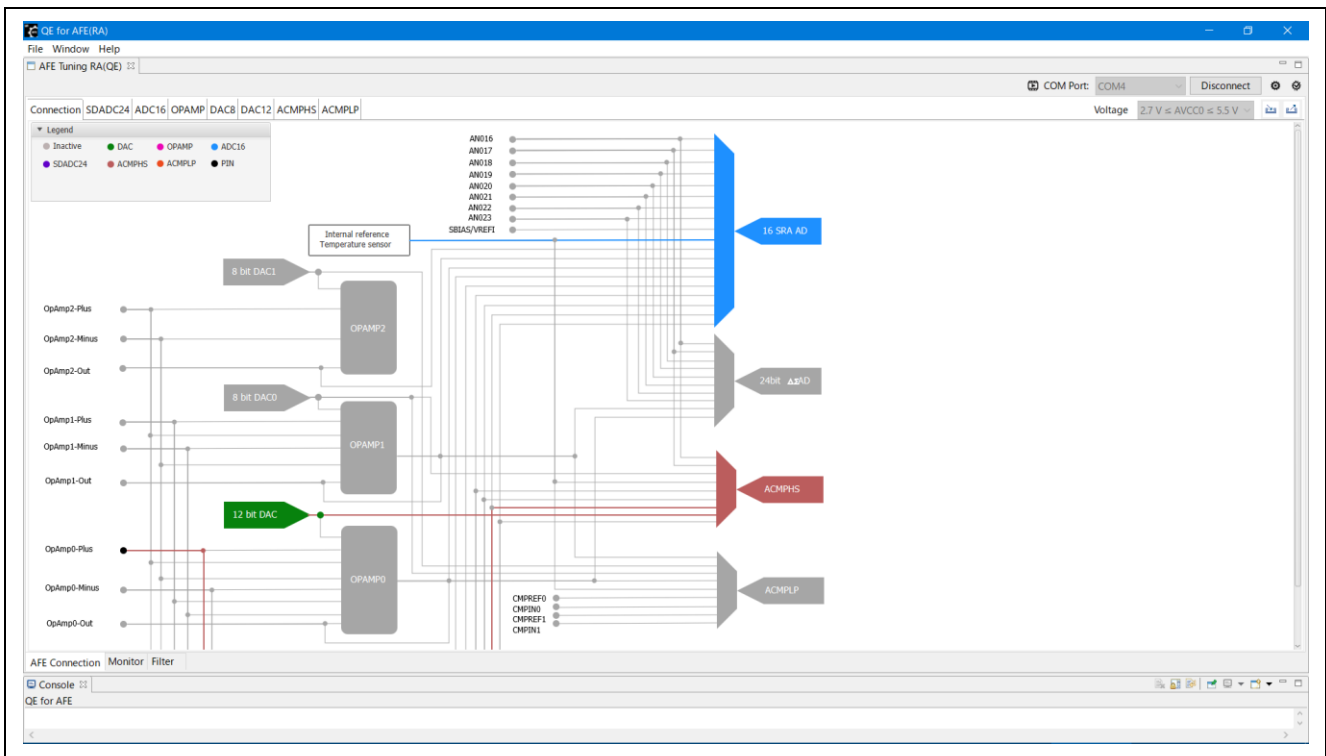


Figure 4-39 Evaluation example of ACMPHS: Connection diagram

The comparator output when the analog signal is input from AN000 pin is displayed in a waveform as shown below.

In case that ACMPHS is selected to be monitored, only the waveform is displayed.

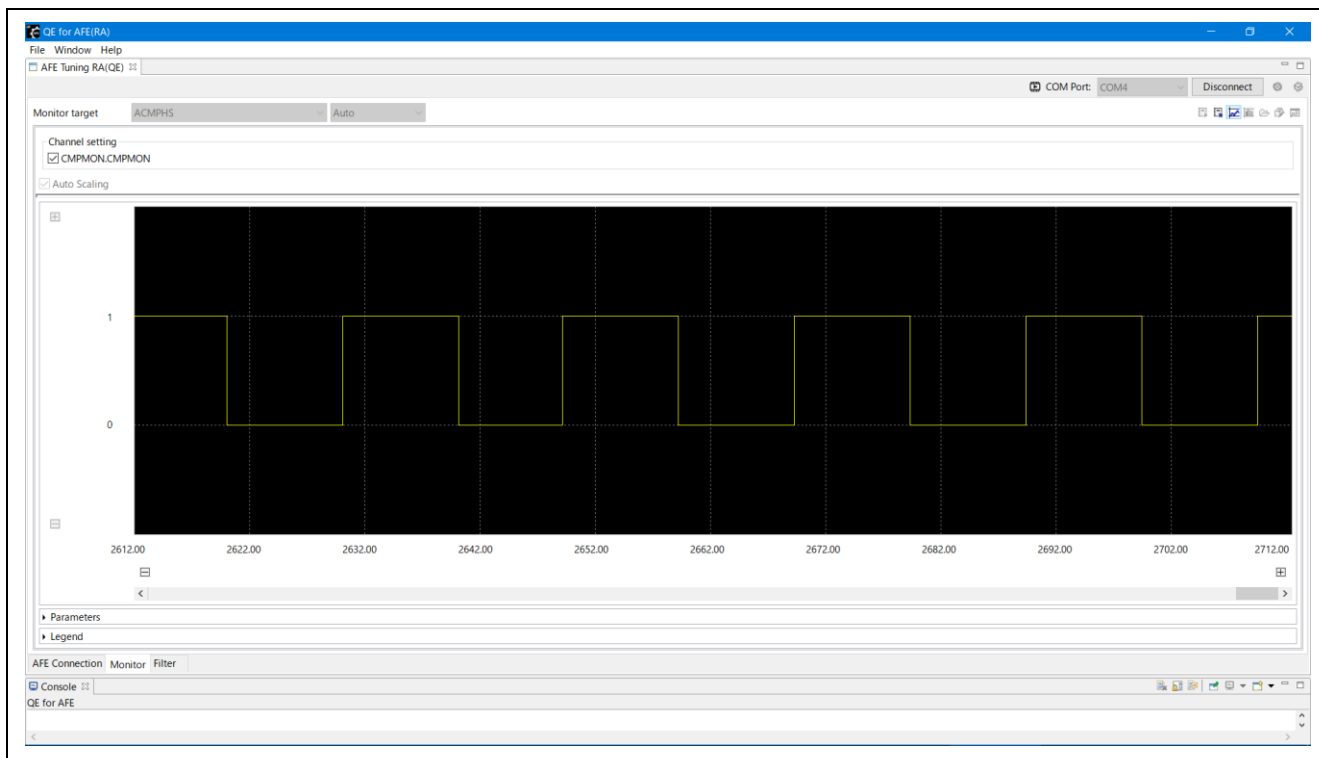


Figure 4-40 Evaluation example of ACMPHS: Display of the waveform

### 4.5 Evaluation example of ACMPLP

This chapter shows an example of two ACMPLP operation as a “window comparator” by comparing the analog signal input from CMPIN1 pin with two DAC8 output as shown in Figure 4-41.

For details of the evaluation procedure, refer to “4.1 Evaluation Procedure”.

- Register setting file: qe\_afe\_sample\_acmplp.2a1

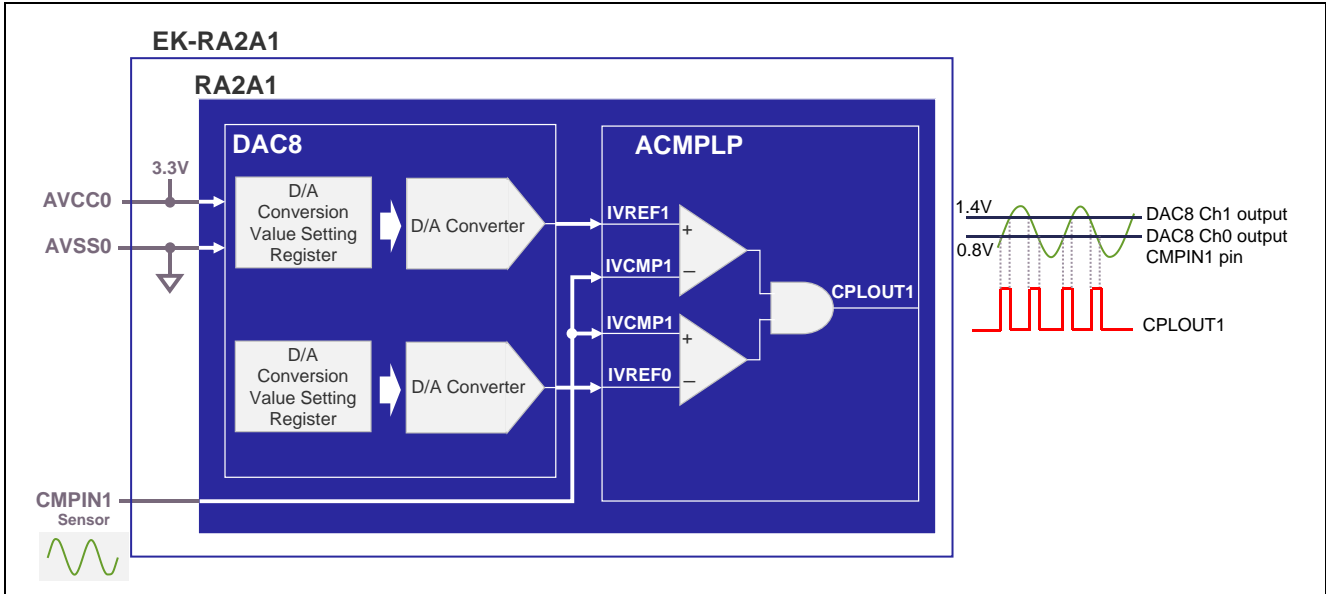


Figure 4-41 Evaluation example of ACMPLP: AFE connection

Once the register setting file is imported, the settings will become as shown in Figure 4-42, Figure 4-43, and Figure 4-44.

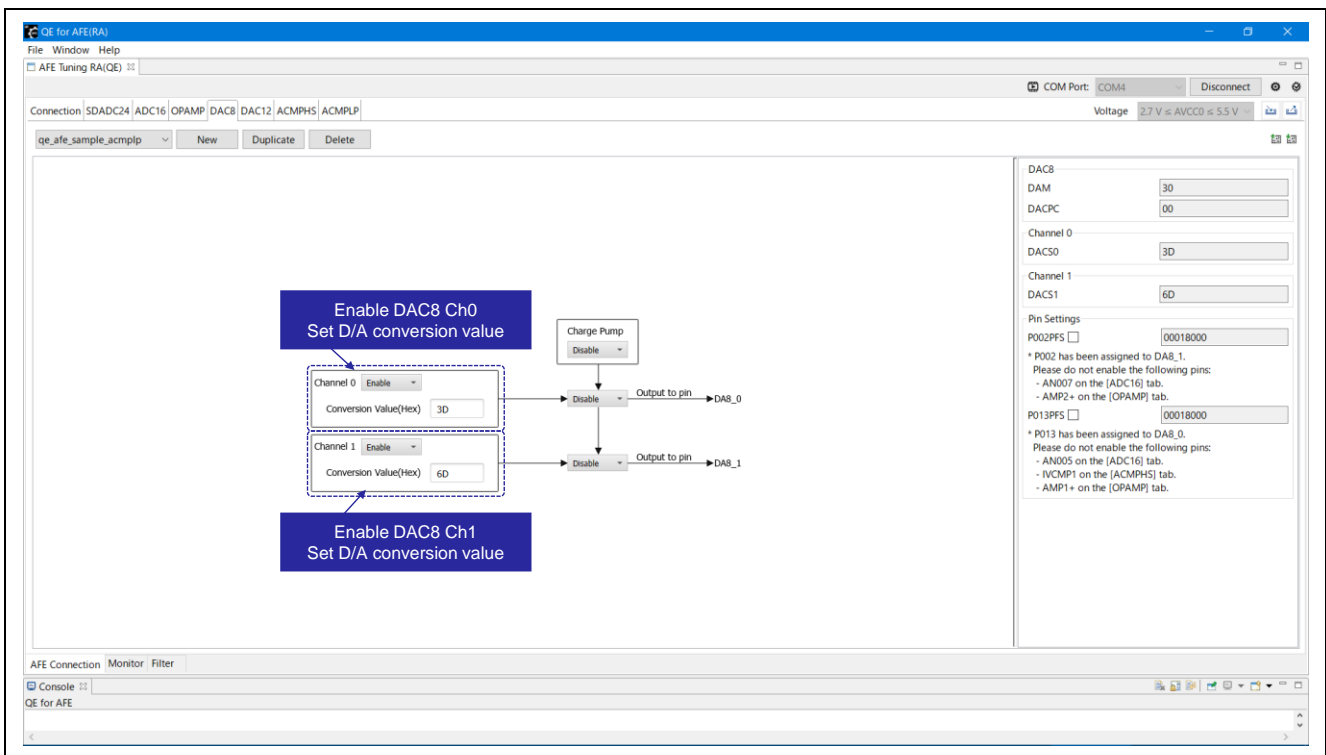


Figure 4-42 Evaluation example of ACMPLP: DAC8 settings

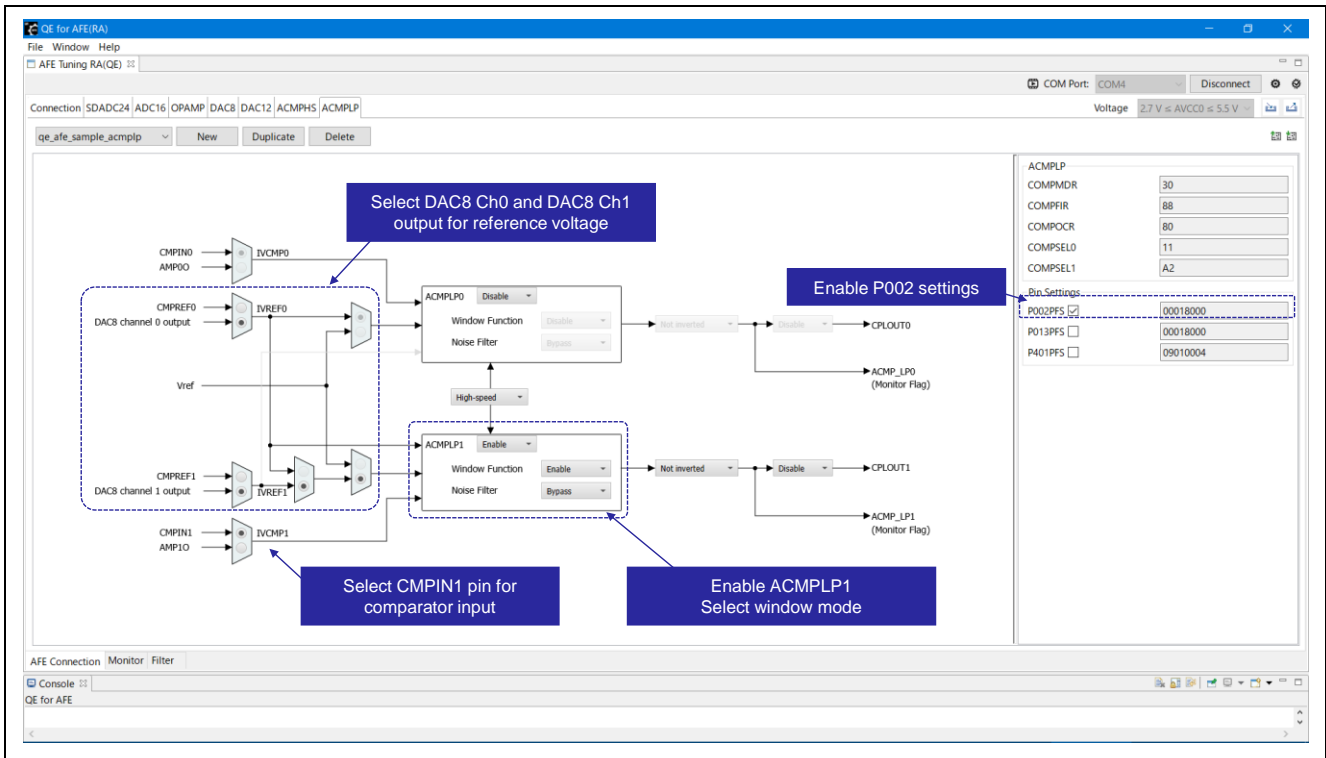


Figure 4-43 Evaluation example of ACMLP: ACMLP settings

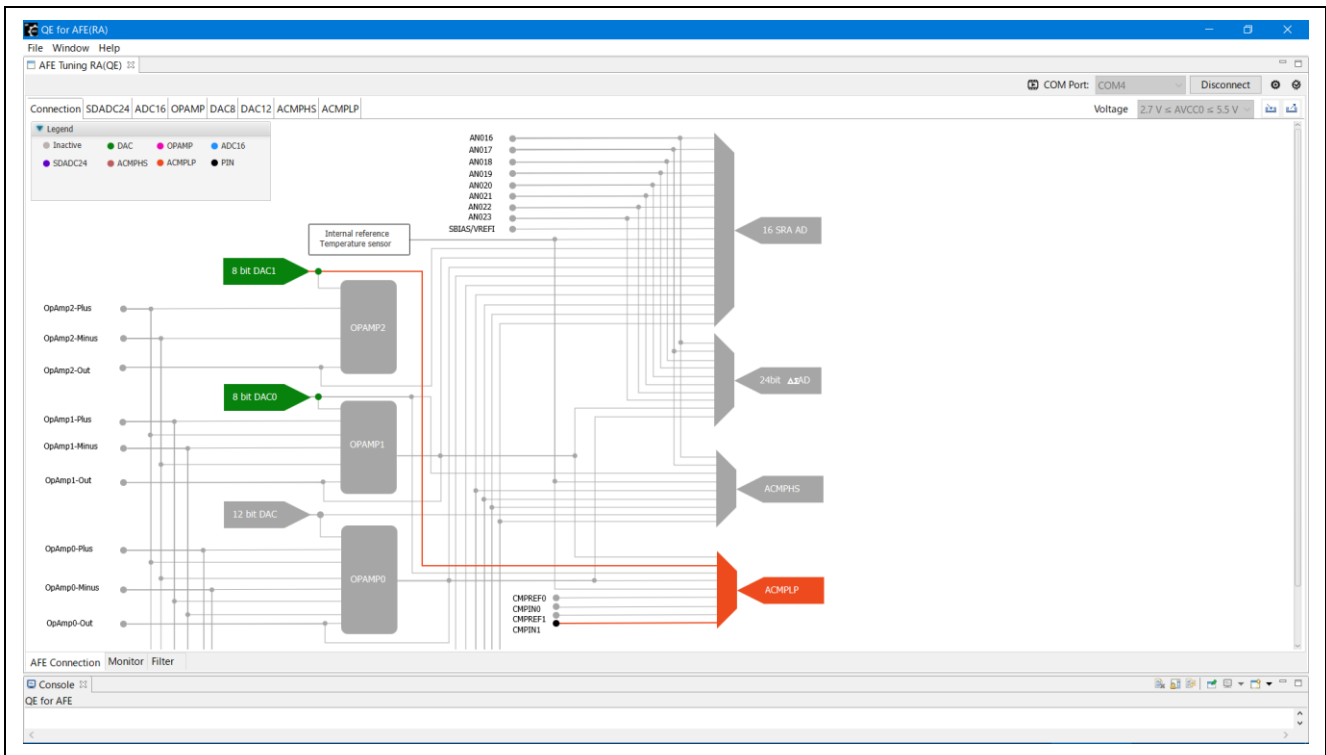


Figure 4-44 Evaluation example of ACMLP: Connection diagram

The comparator output when the analog signal is input from CMPIN1 pin is displayed in a waveform as shown below.

In case that ACMPLP is selected to be monitored, only the waveform is displayed.

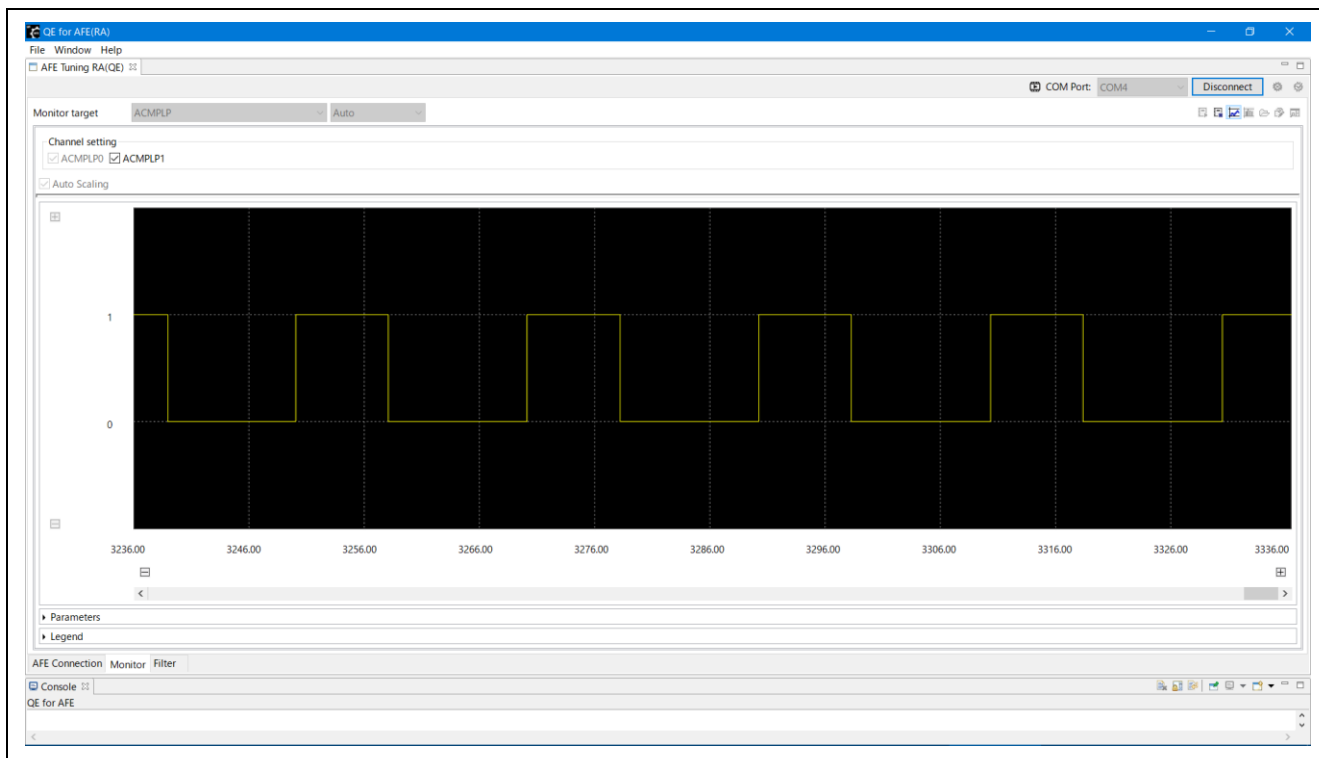


Figure 4-45 Evaluation example of ACMPLP: Display of the waveform

### 5. Explanation of Functions

The QE for AFE has three main functions. Each function can be selected on the tabs at the bottom of the QE for AFE.

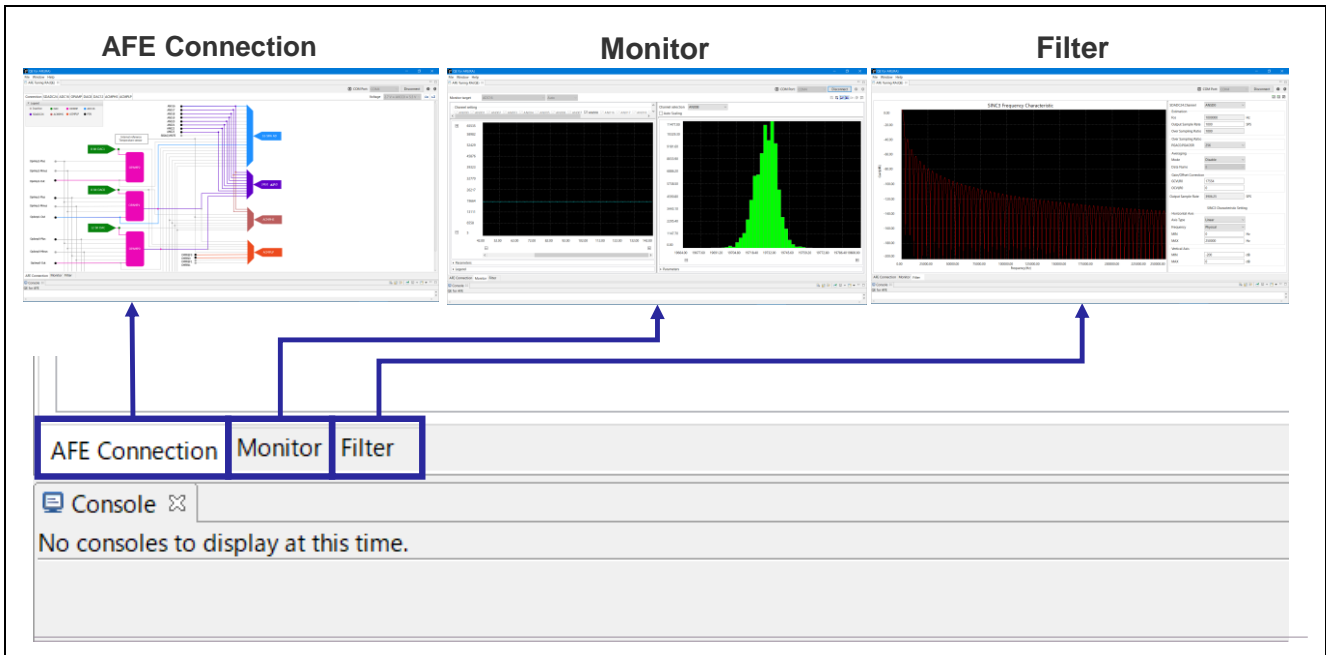


Figure 5-1 Functions of the QE for AFE

Table 5-1 Function tabs of the QE for AFE

Tab name	Description
<b>AFE Connection</b>	The block diagram of the analog functions of RA2A1 is displayed, and each analog function can be set on the GUI. The register setting value based on this setting can be reflected to the RA2A1 on the target board. It also displays the entire connection diagram based on the settings for each function.
<b>Monitor</b>	Obtains the A/D conversion value from the target board, and displays the waveform and histogram. Output signal from the comparator can also be displayed as waveform in here.
<b>Filter</b>	SINC3 filter-related registers can be set. The register setting value can be reflected to the RA2A1 on the target board. SINC3 filter frequency-Gain characteristic graph is also displayed based on the settings.

### 5.1 AFE Connection

By selecting the “AFE Connection” tab, it is possible to set the analog functions on the block diagram.



Figure 5-2 “AFE Connection” tab

The register value based on this setting can be reflected to the RA2A1 on the target board. It also displays the entire connection diagram based on the settings for each function.

Each setting can be saved to the file. And it is also possible to reflect the saved setting to the QE for AFE by reading the file.

For details on each analog function and register value, refer to “RA2A1 Group User’s Manual: Hardware”.

#### 5.1.1 Common Functions

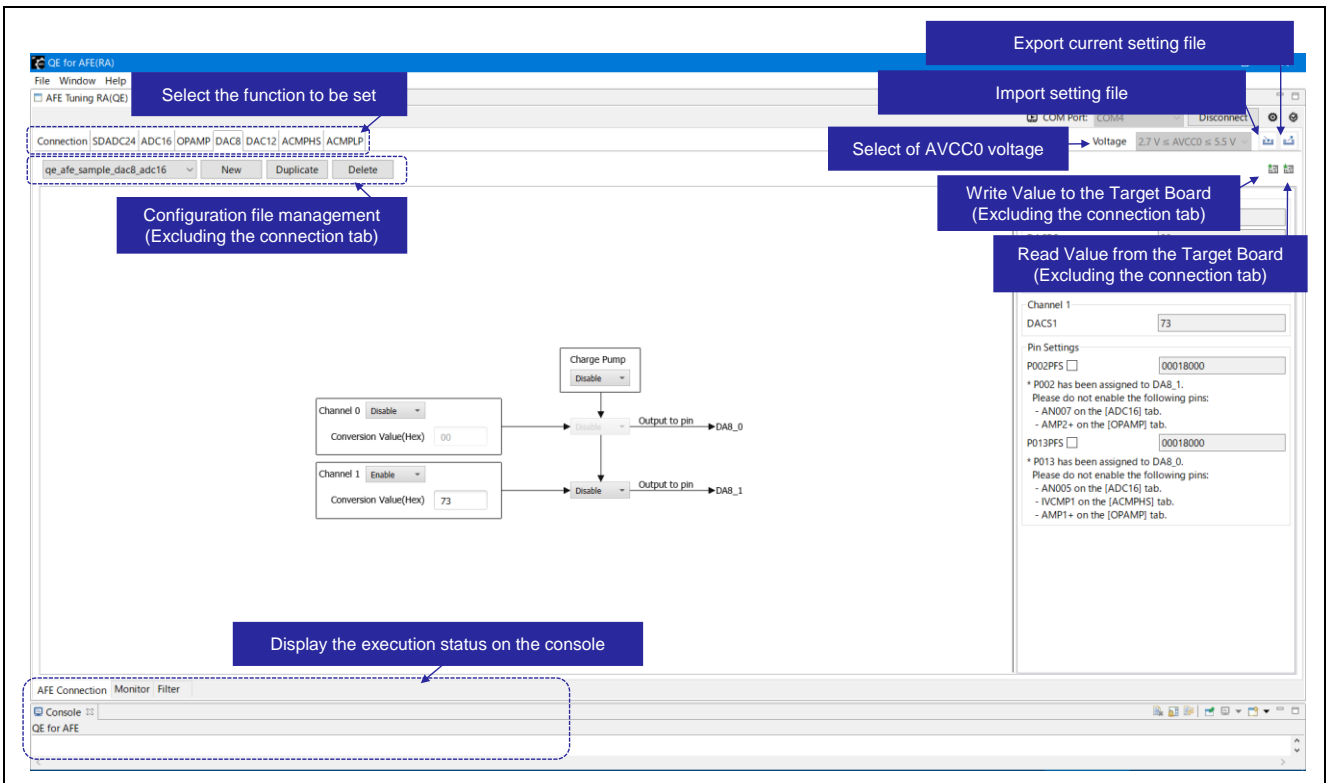
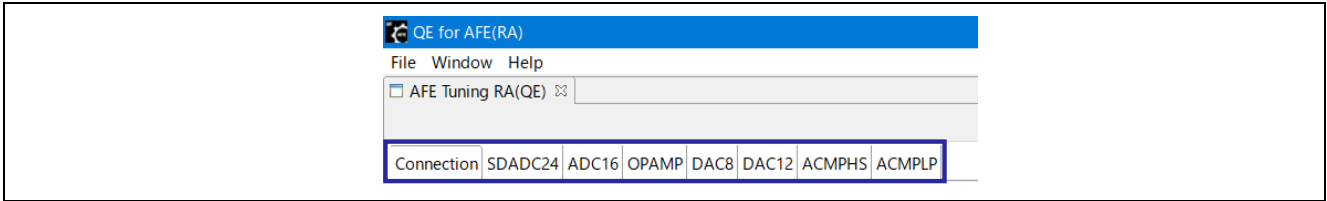


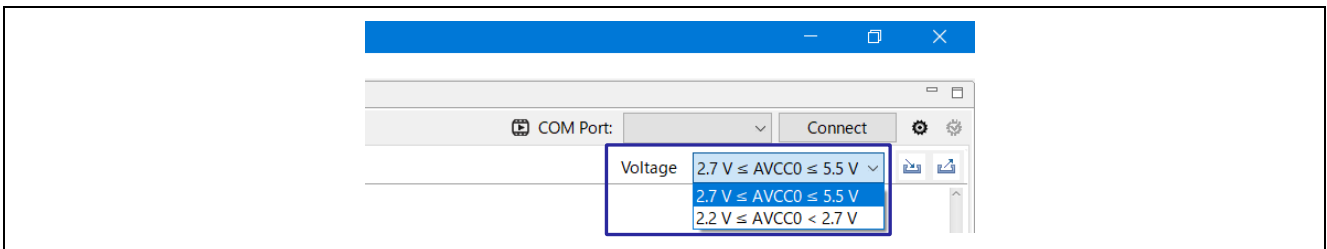
Figure 5-3 AFE Connection: Common functions

- Selecting of function to be set  
 The analog function to be set can be selected from the tabs. For details of each tab will be explained in the following chapters.



**Figure 5-4 AFE Connection: Selecting of function to be set**





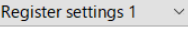
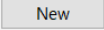
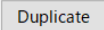

- Selecting of AVCC0 voltage  
 The AVCC0 voltage to be supplied to the target board can be selected from the pull-down menu as shown below. It cannot be changed while connecting the QE for AFE and the target board.



**Figure 5-5 AFE Connection: Selecting of AVCC0 voltage**



Table 5-2 AFE Connection: Common functions

Icon	Description	Condition		
		Before connection	After connection <sup>Note</sup>	
			Stop	Running
	Import the register settings from the file, and reflect to the QE for AFE. The function to be imported is selectable. The extension of the import file is ".2a1", and the file can be saved to any location.	✓	✓	
	Export the register settings of the QE for AFE to the file. The function to be exported is selectable. The extension of the export file is ".2a1", and the file can be saved to any location	✓	✓	
	Reflect the register value of the QE for AFE to RA2A1. This operation will be done only for the function which is selected.		✓	
	Reflect the register value of RA2A1 to the QE for AFE. This operation will be done only for the function which is selected.		✓	
	The currently selected configuration file name is displayed. It is also possible to change to another configuration file from the pull-down menu. In case to change the configuration file, the configuration file before the change will be automatically saved. The configuration file is saved by each function in the "afeConfig" folder in the folder where the QE for AFE is unzipped. The import operation will be done for multiple functions, while this configuration file operation will be done only for the selected function. The extension of the configuration file is ".cn".	✓	✓	✓
	The register settings of the QE for AFE will be reset to the initial value of RA2A1, and create another configuration file with a different name. The register settings before this operation will be automatically saved in the configuration file.	✓	✓	✓
	The configuration file will be duplicated with a different name.	✓	✓	✓
	The selected configuration file will be deleted.	✓	✓	✓

Note. After connecting the QE for AFE and the target board, the condition when AFE tuning is stopped and when AFE tuning is running is different.

### 5.1.2 Connection tab

By selecting the “Connection” tab, the entire connection diagram based on each analog function setting is displayed.

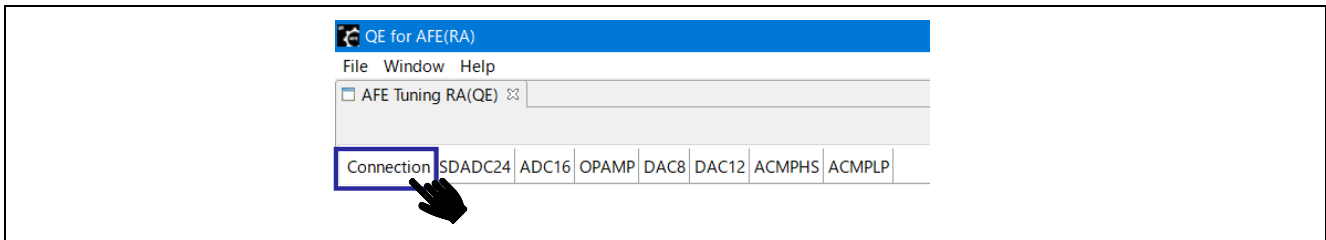


Figure 5-6 AFE Connection: Connection tab

You can check the connection status of the analog function on this screen. There are no items to set on this screen.

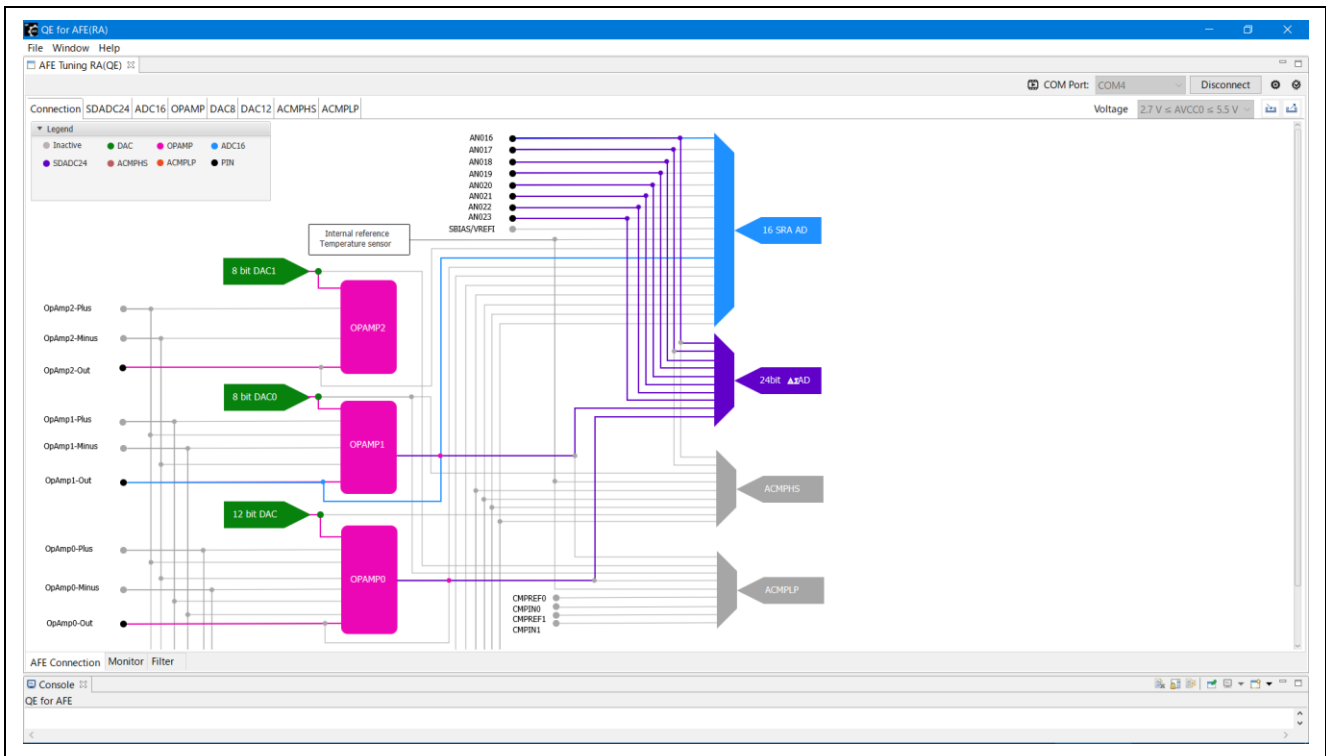


Figure 5-7 AFE connection diagram

5.1.3 SDADC24 tab

By selecting the “SDADC24” tab, the block diagram and register value of the 24-bit delta-sigma A/D converter (SDADC24) is displayed.

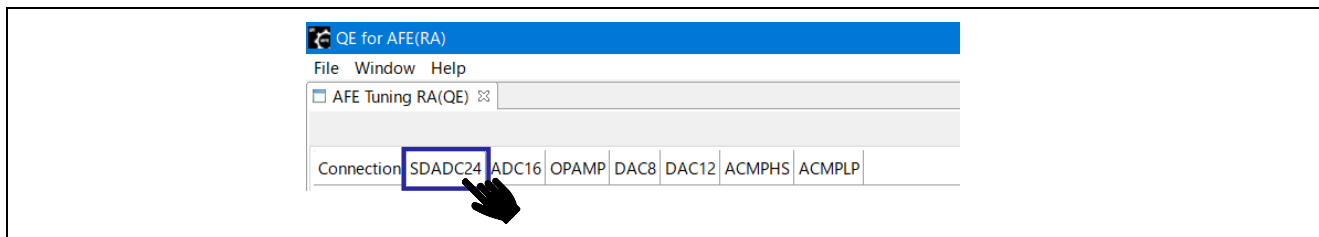


Figure 5-8 AFE Connection: SDADC24 tab

Each function of SDADC24 can be set on the block diagram. Figure 5-9 ~ Figure 5-11 show the related register names for each function.

For SINC3, refer to “5.3.1 Frequency characteristics of SINC3”, and for calibration, refer to “5.4 Calibration”.

The frequency of the source clock of SDADCCLK SRC of SDADC24 is obtained from the target board and reflected on the block diagram. When setting SDADC24, connect the QE for AFE to the target board.

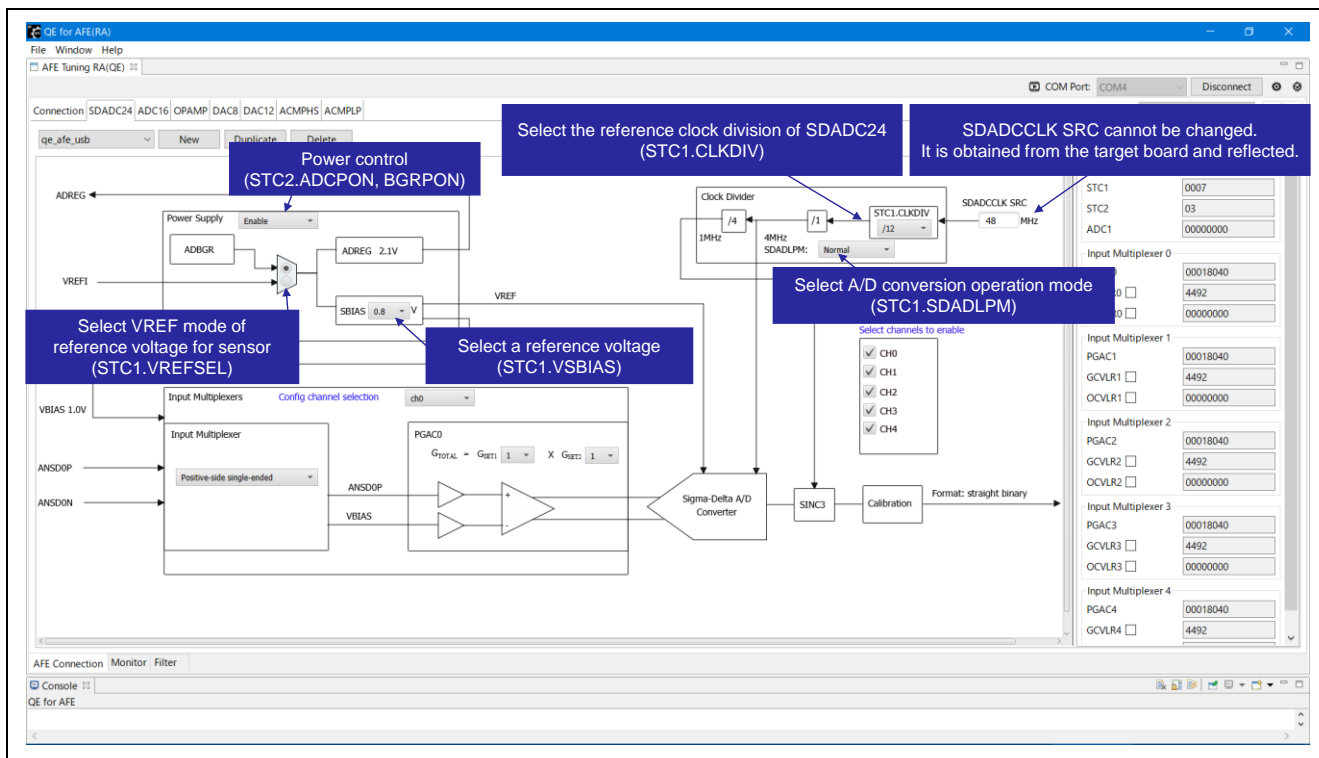


Figure 5-9 AFE Connection: SDADC24 voltage reference and clock settings

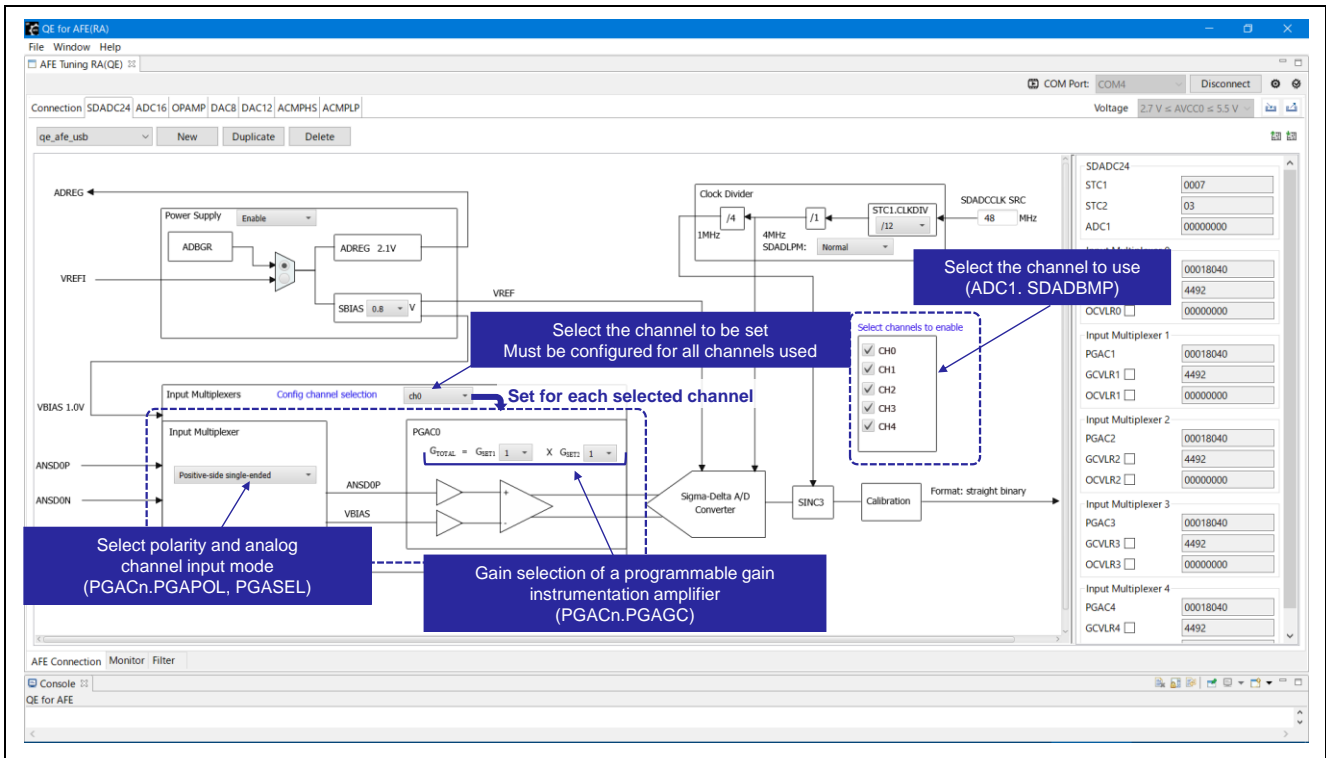


Figure 5-10 AFE Connection: SDADC24 channel settings

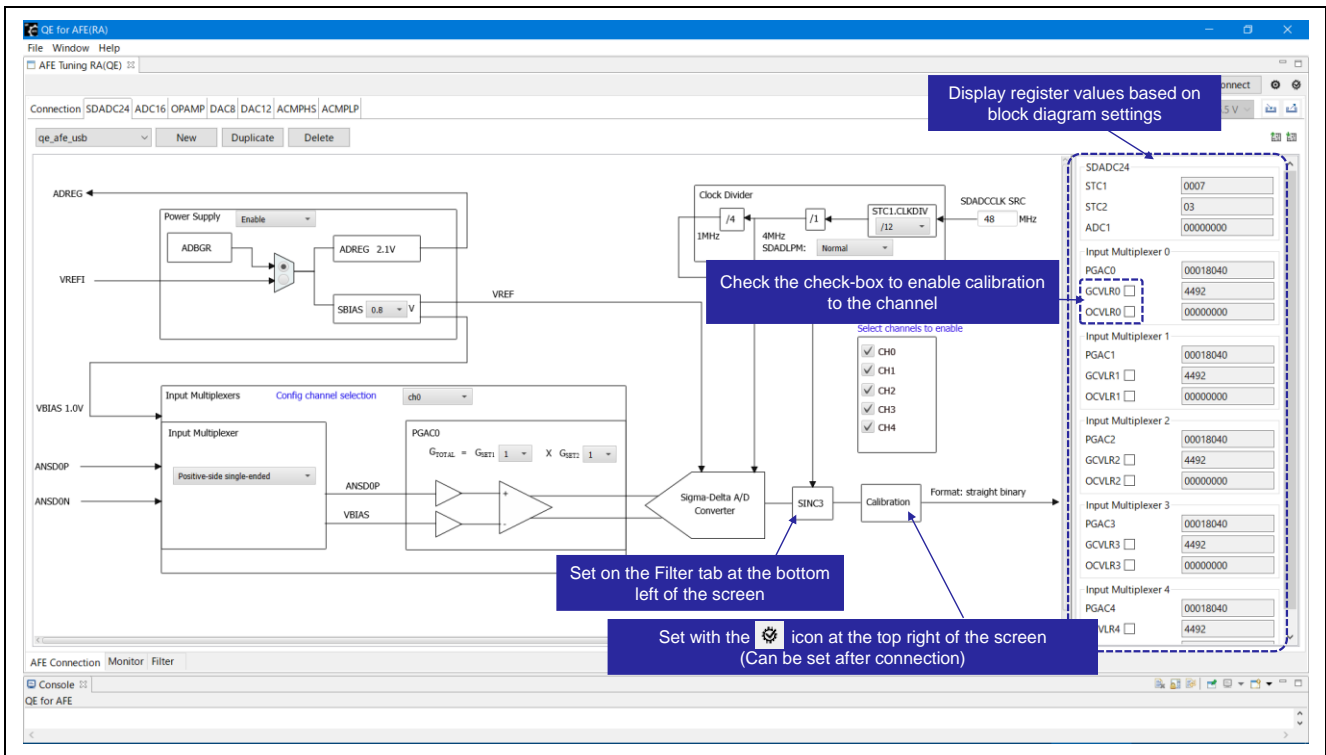


Figure 5-11 AFE Connection: SDADC24 register settings

5.1.4 ADC16 tab

By selecting the “ADC16” tab, the block diagram and register value of the 16-bit A/D converter (ADC16) is displayed.

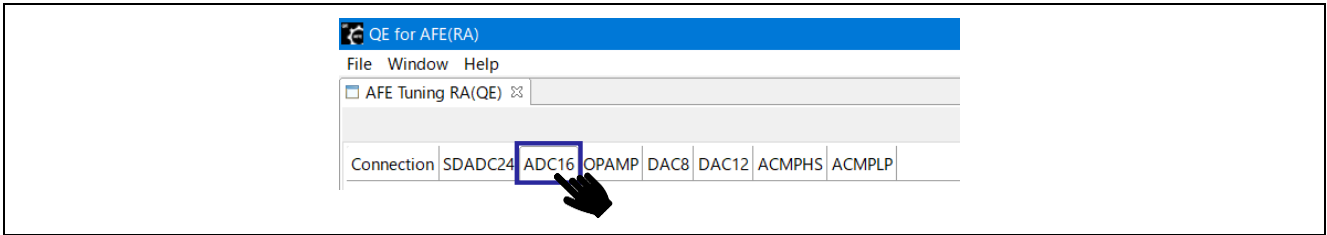


Figure 5-12 AFE Connection: ADC16 tab

Each function of ADC16 can be set on the block diagram. Figure 5-13 ~ Figure 5-15 show the related register names for each function.

The frequency of the ADC16 peripheral module clock PCLKB and the A/D conversion clock PCLKD are obtained from the target board and reflected on the block diagram. When setting ADC16, connect the QE for AFE to the target board.

On the EK-RA2A1 board, VREFH0 and VREFL0 are open. Refer to “2.3.2 Reference voltage pin connection setting when using ADC16” and connect the reference voltage to the pin to be used.

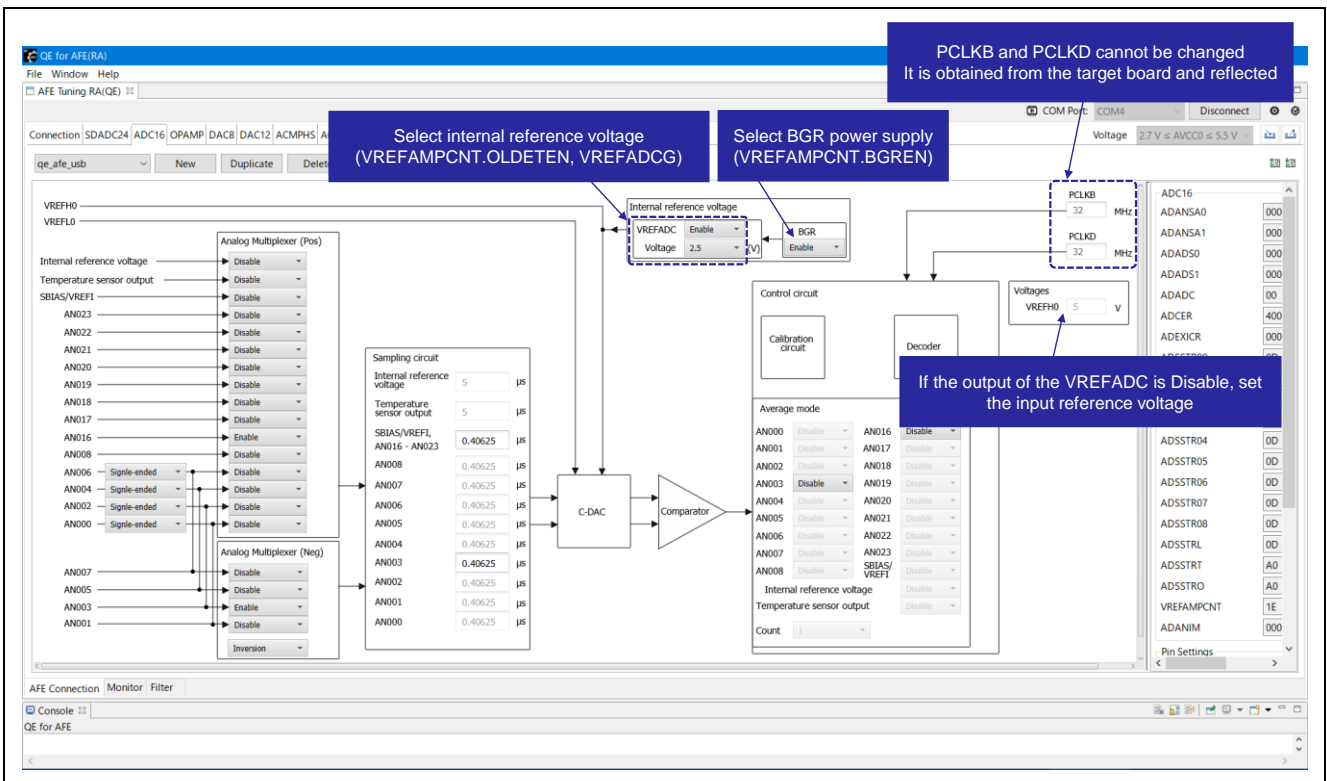


Figure 5-13 AFE Connection: ADC16 voltage reference and clock settings

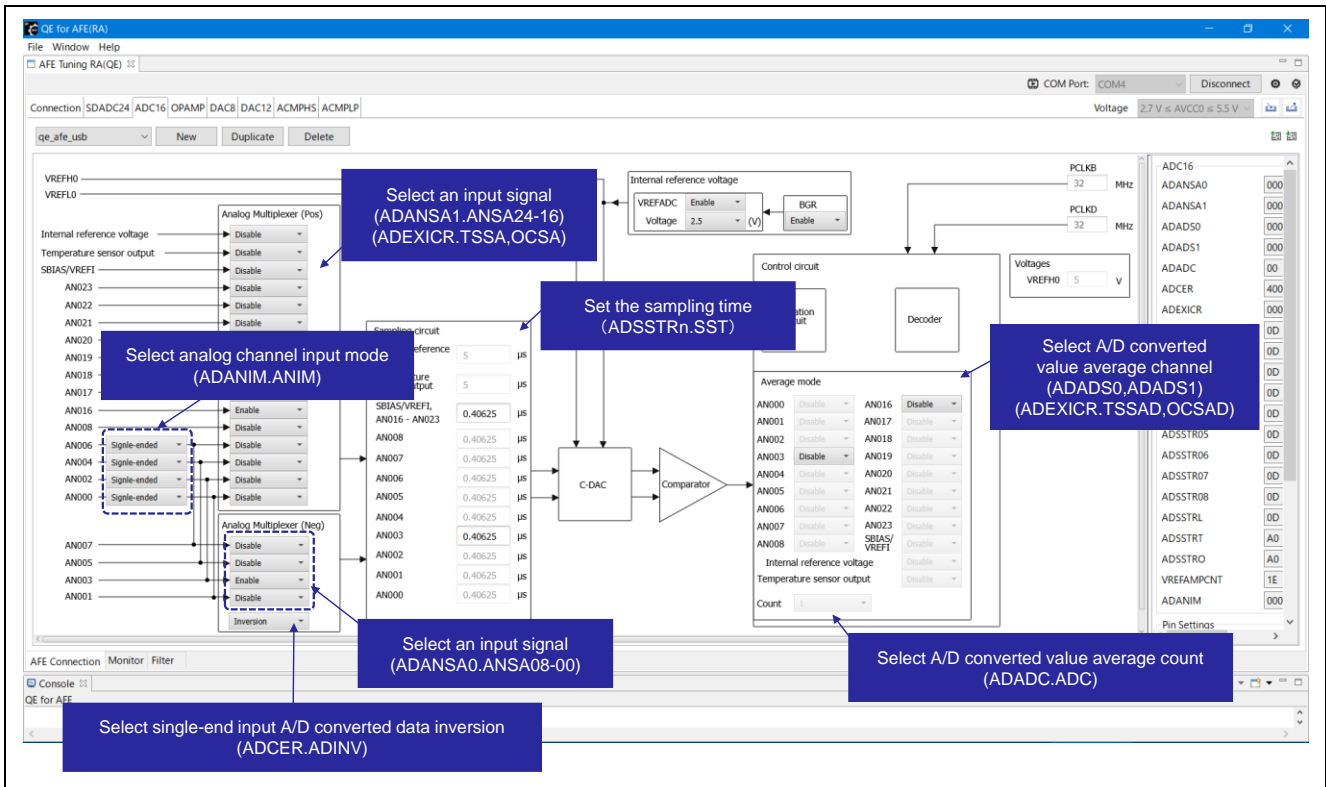


Figure 5-14 AFE Connection: ADC16 Input / Output settings

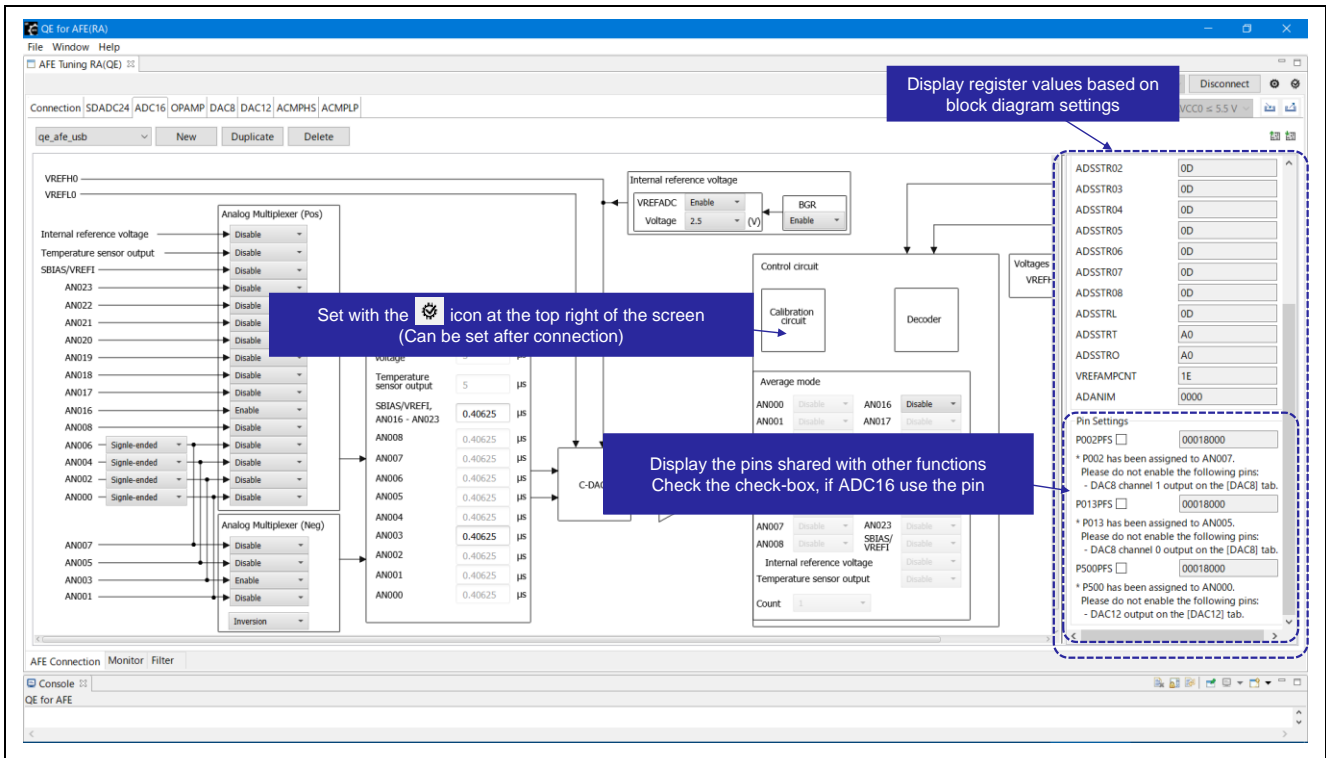


Figure 5-15 AFE Connection: ADC16 register settings

5.1.5 OPAMP tab

By selecting the “OPAMP” tab, the block diagram and register value of the operational amplifier (OPAMP) is displayed.

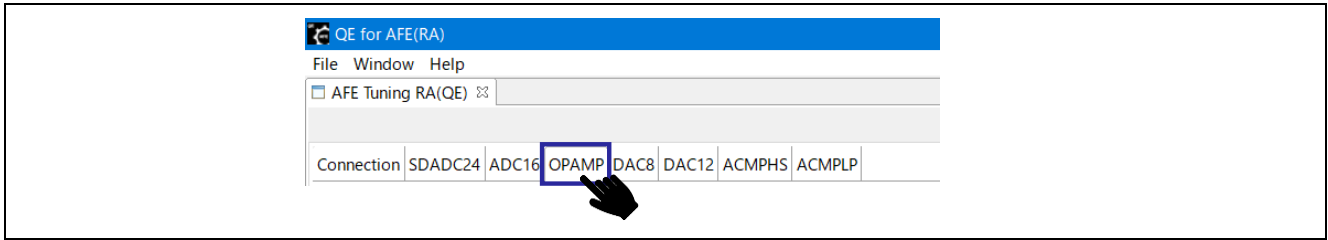


Figure 5-16 AFE Connection: OPAMP tag

Each function of OPAMP can be set on the block diagram. Figure 5-17 and Figure 5-18 show the related register names for each function.

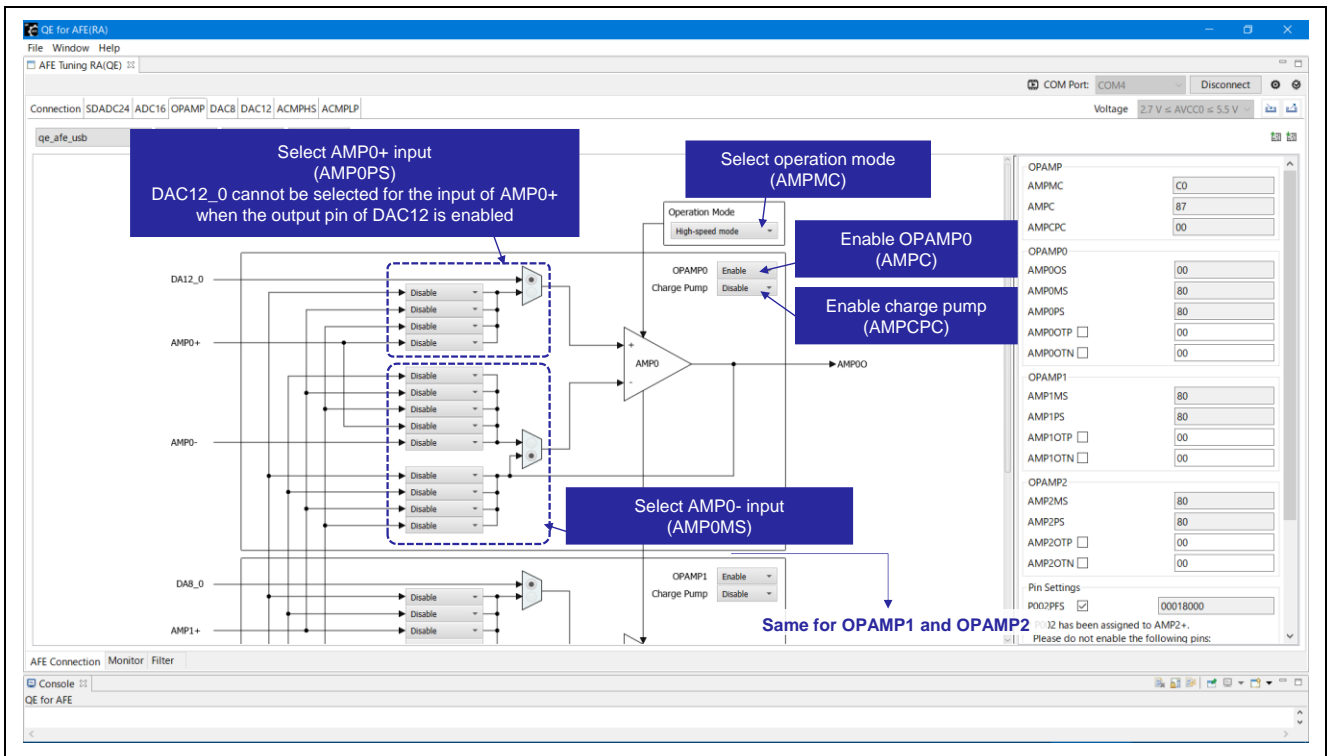


Figure 5-17 AFE Connection: OPAMP settings

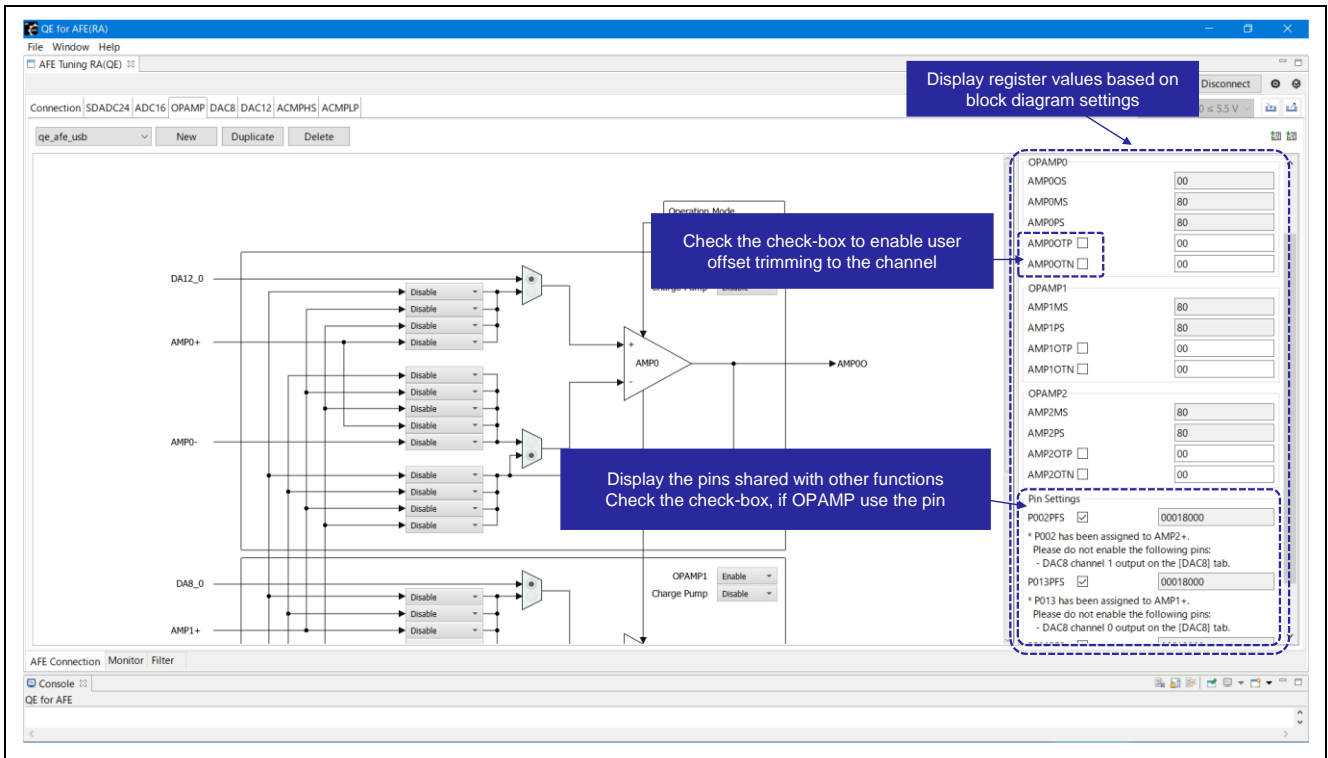


Figure 5-18 AFE Connection: OPAMP register settings



### 5.1.6 DAC8 tab

By selecting the “DAC8” tab, the block diagram and register value of the 8-bit D/A converter (DAC8) is displayed.

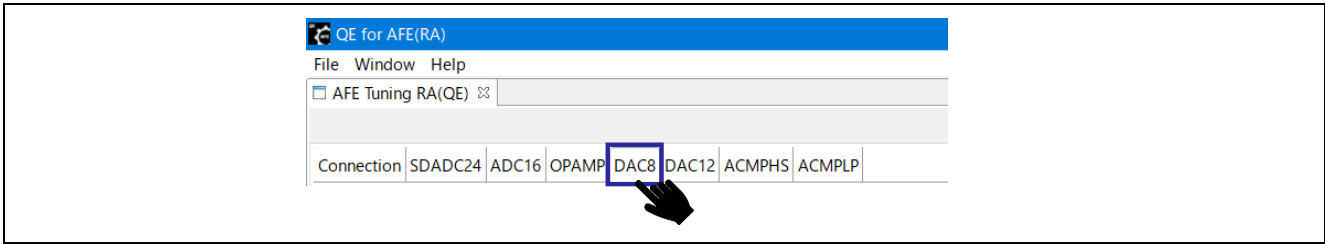


Figure 5-19 AFE connection: DAC8 tab

Each function of DAC8 can be set on the block diagram. Figure 5-20 and Figure 5-21 show the related register names for each function.

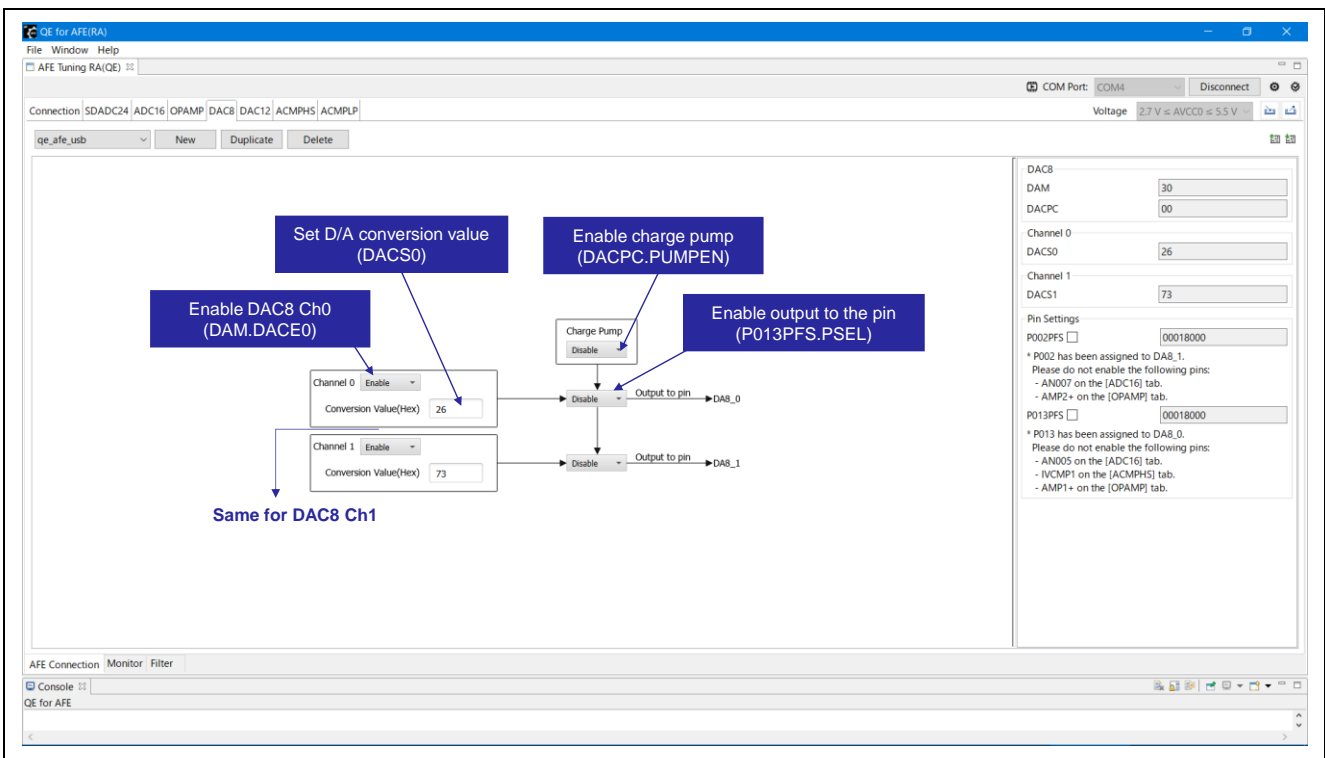


Figure 5-20 AFE Connection: DAC8 Input / Output settings

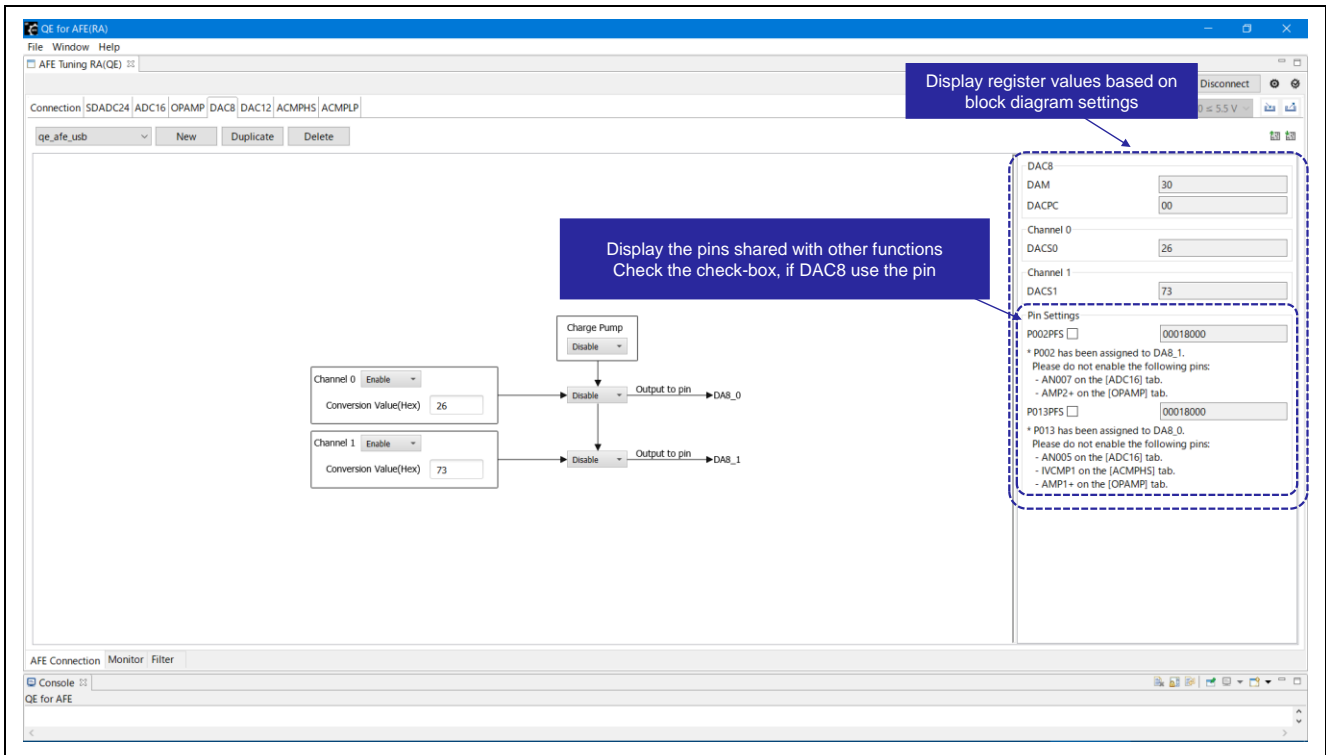


Figure 5-21 AFE Connection: DAC8 register settings

### 5.1.7 DAC12 tab

By selecting the “DAC12” tab, the block diagram and register value of the 12-bit D/A converter (DAC12) is displayed.

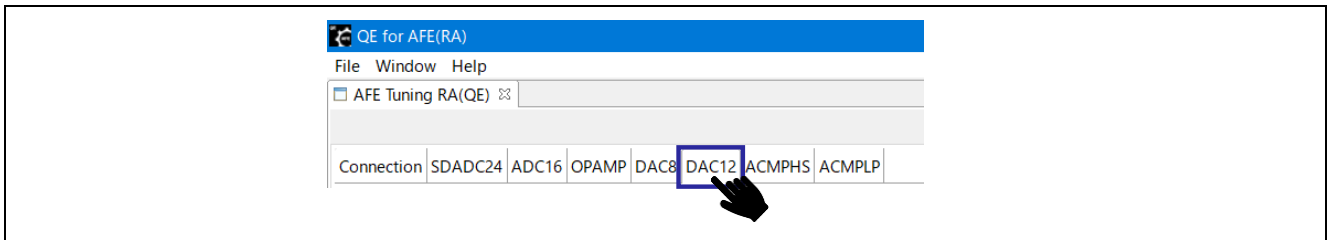


Figure 5-22 AFE connection: DAC12 tab

Each function of DAC12 can be set on the block diagram. Figure 5-23 ~ Figure 5-25 show the related register names for each function.

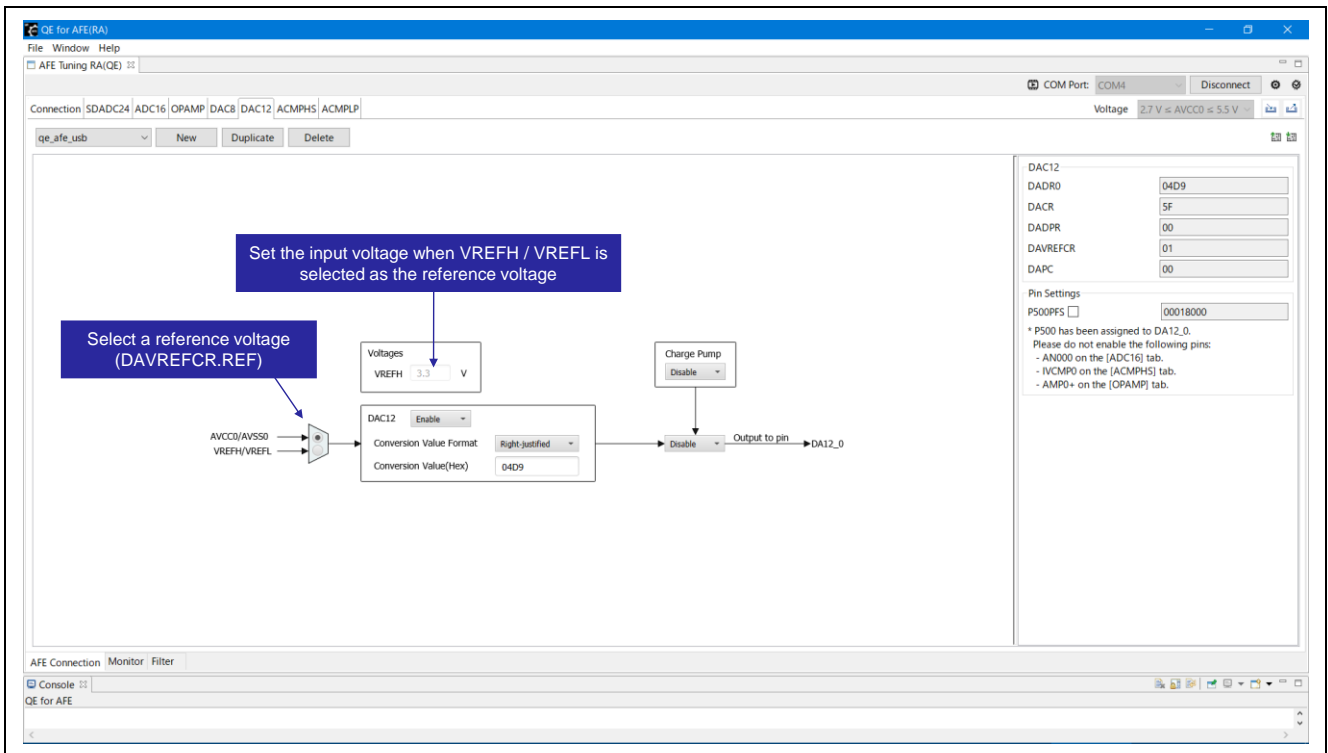


Figure 5-23 AFE Connection: DAC12 voltage reference settings

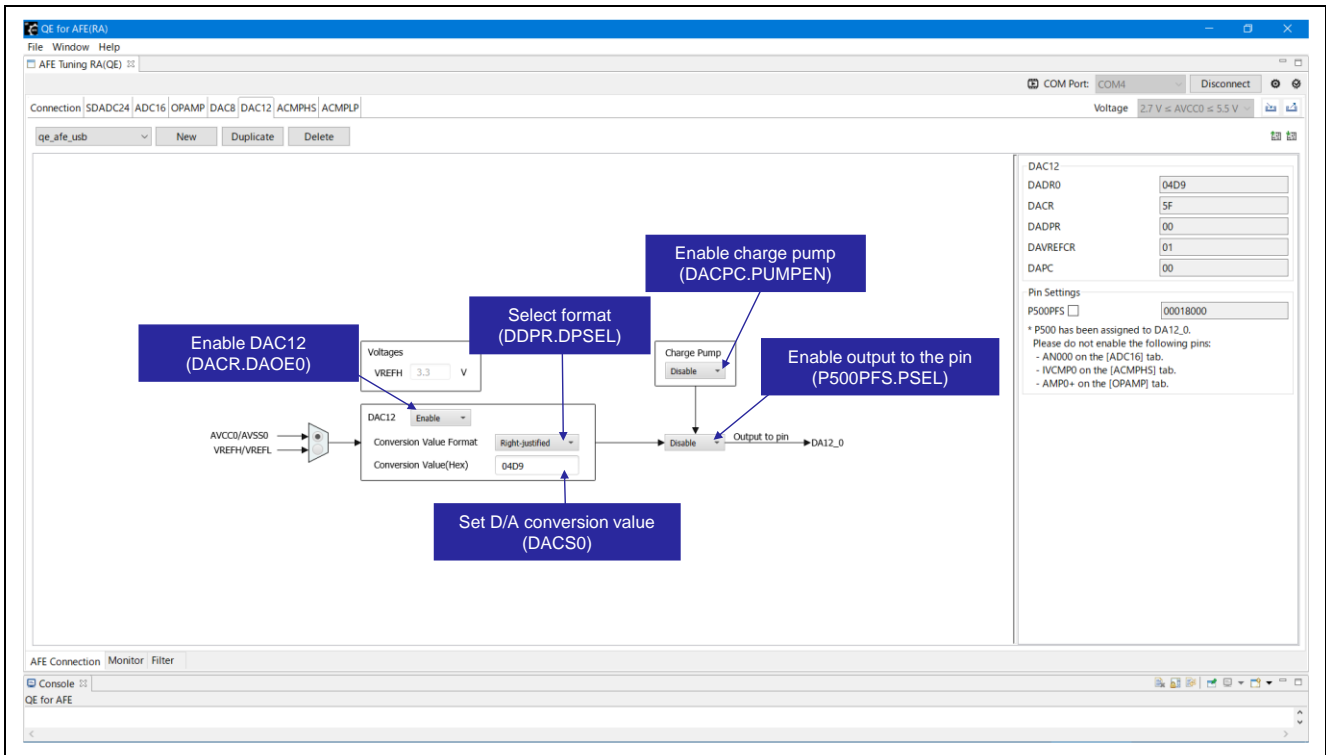


Figure 5-24 AFE Connection: DAC12 Input / Output settings

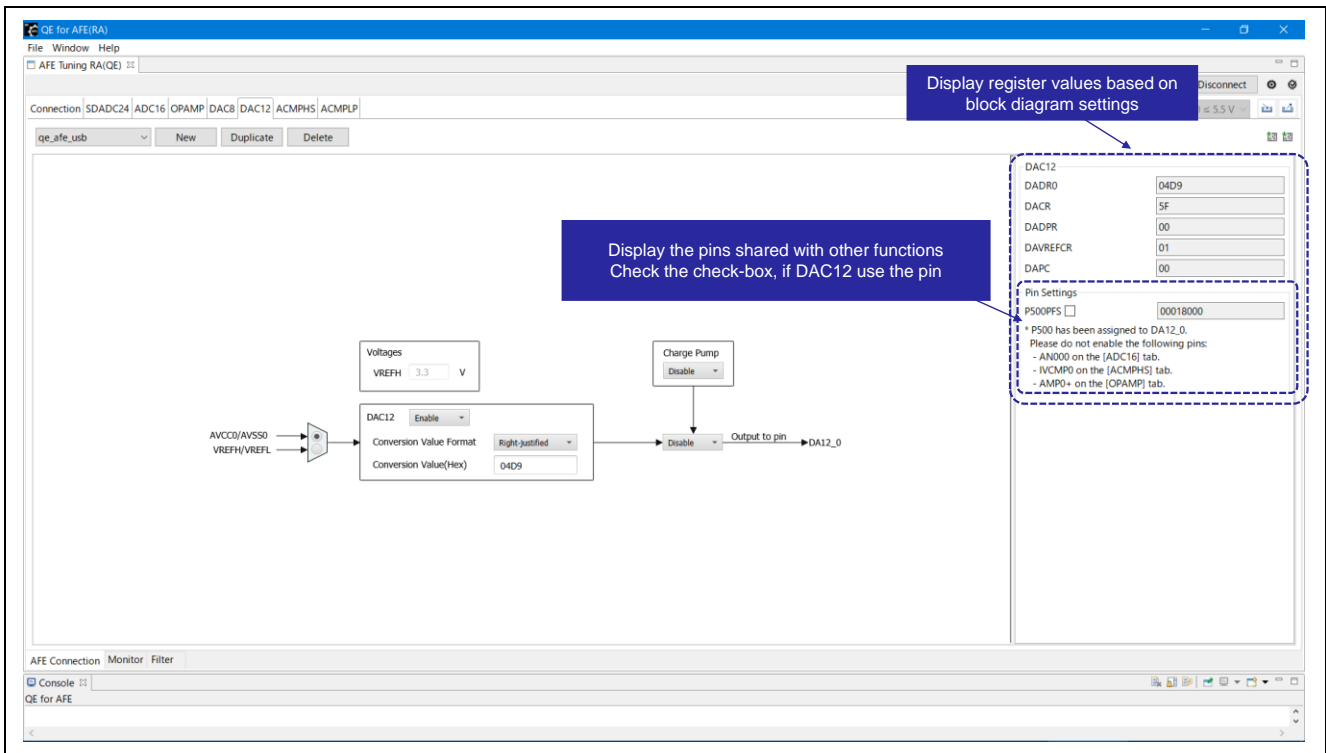


Figure 5-25 AFE Connection: DAC12 register settings

5.1.8 ACPHNS tab

By selecting the “ACMPHNS” tab, the block diagram and register value of the high-speed analog comparator (ACMPHNS) is displayed.

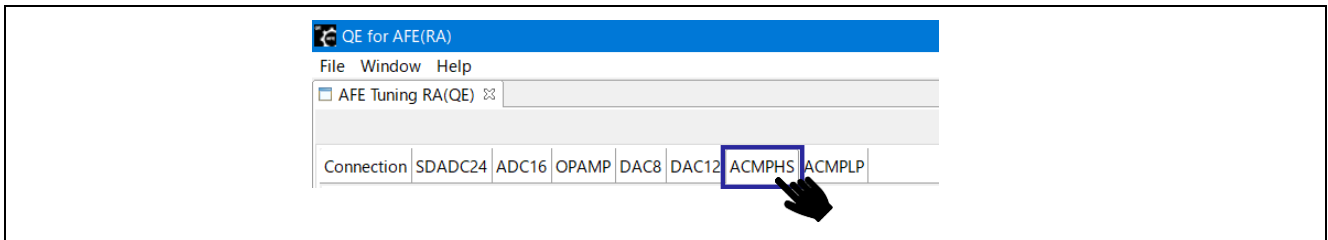


Figure 5-26 AFE connection: ACPHNS tab

Each function of ACPHNS can be set on the block diagram. Figure 5-27 and Figure 5-28 show the related register names for each function.

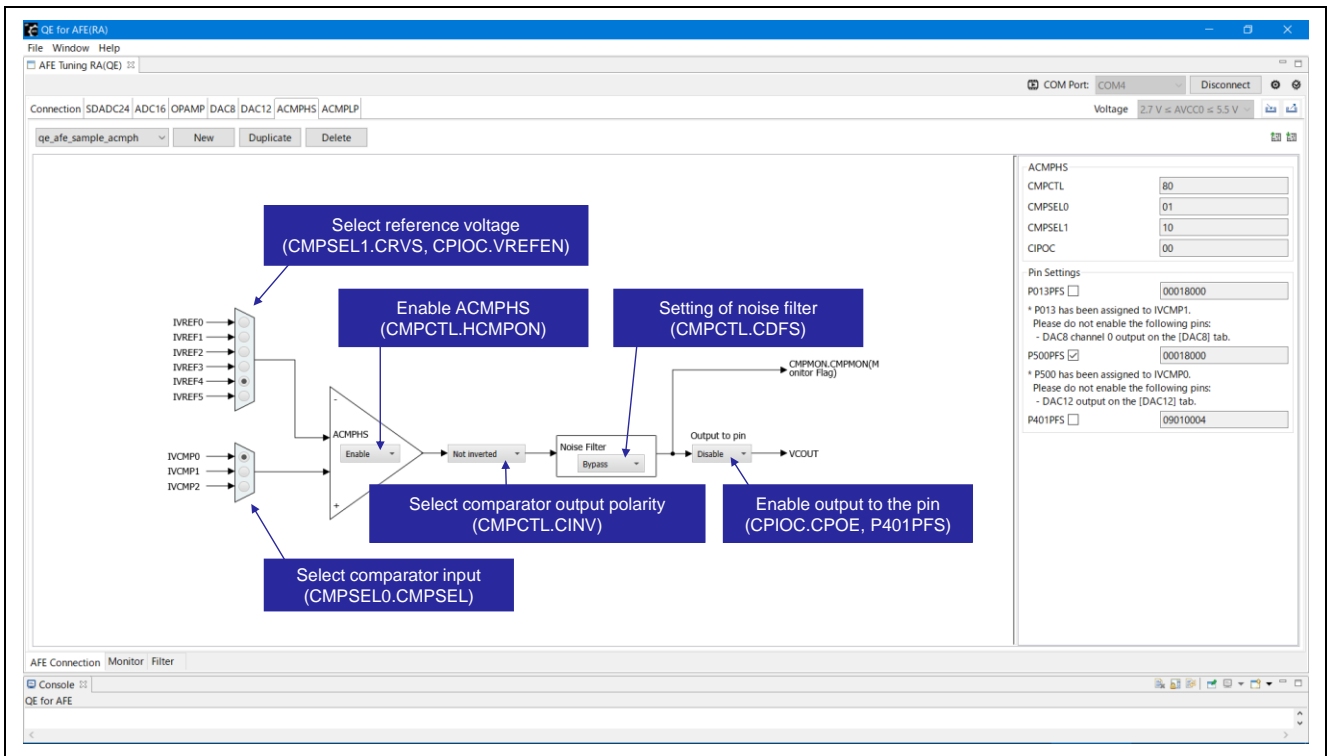


Figure 5-27 AFE Connection: ACPHNS settings

The screenshot shows the 'QE for AFE(RA)' software interface. The main window displays a block diagram of the ACMPHS voltage reference circuit. The circuit includes several input pins (IVREF0-5 and IVCMP0-2), an ACMPHS block with an 'Enable' dropdown, a 'Not inverted' dropdown, a 'Noise Filter' block with a 'Bypass' dropdown, and an 'Output to pin' dropdown leading to 'VCOUT'. The settings panel on the right shows the following values:

ACMPHS	
CMPCTL	80
CMPSEL0	01
CMPSEL1	10
CIPOC	00
Pin Settings	
P013PFS	<input type="checkbox"/> 00018000
P013 has been assigned to IVCMP1. Please do not enable the following pins: - DAC8 channel 0 output on the [DAC8] tab.	
P500PFS	<input checked="" type="checkbox"/> 00018000
P500 has been assigned to IVCMP0. Please do not enable the following pins: - DAC12 output on the [DAC12] tab.	
P401PFS	<input type="checkbox"/> 09010004

Annotations in the image include:

- 'Display register values based on block diagram settings' pointing to the settings panel.
- 'Display the pins shared with other functions Check the check-box, if ACMPHS use the pin' pointing to the pin settings section.

Figure 5-28 AFE Connection: ACMPHS voltage reference and register settings

### 5.1.9 ACMLP tab

By selecting the “ACMLP” tab, the block diagram and register value of the low-power analog comparator (ACMLP) is displayed.

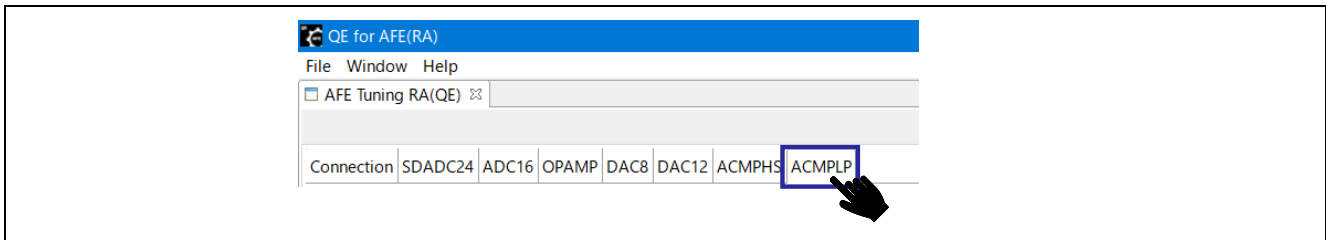


Figure 5-29 AFE connection: ACMLP tab

Each function of ACMLP can be set on the block diagram. Figure 5-30 ~ Figure 5-32 show the related register names for each function.

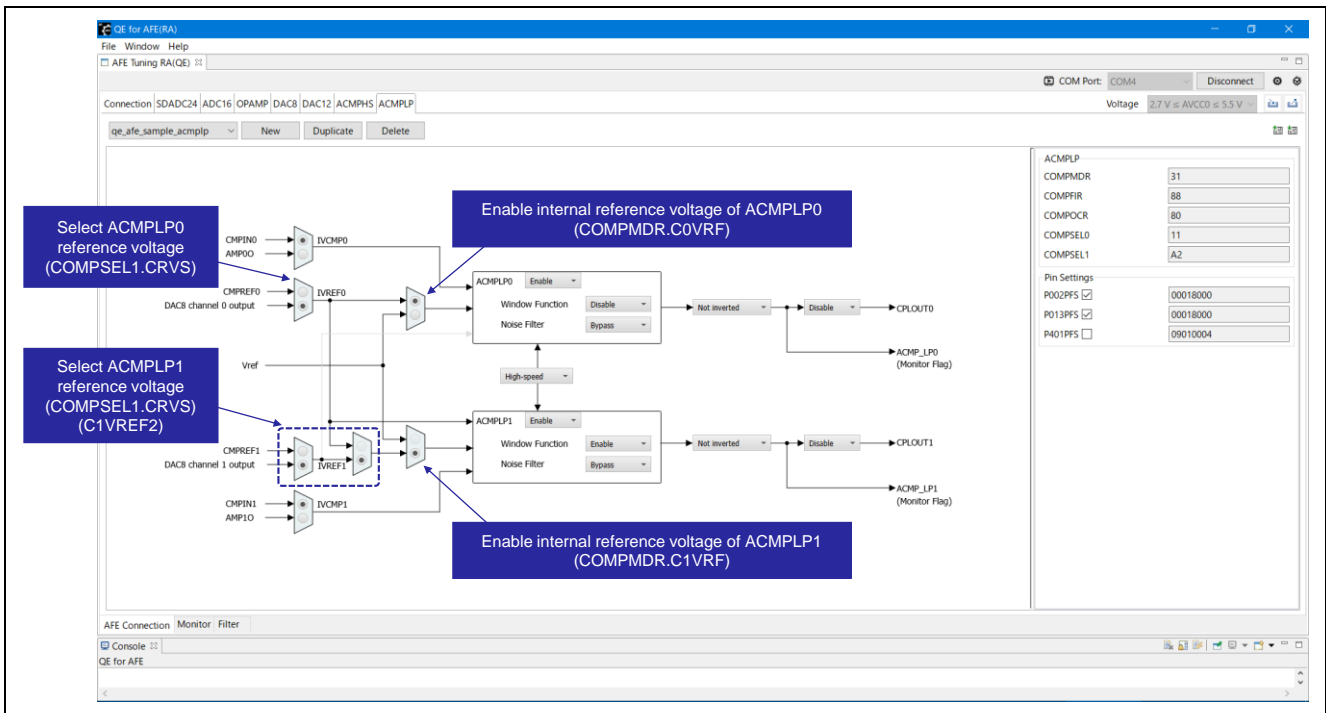


Figure 5-30 AFE Connection: ACMLP voltage reference settings

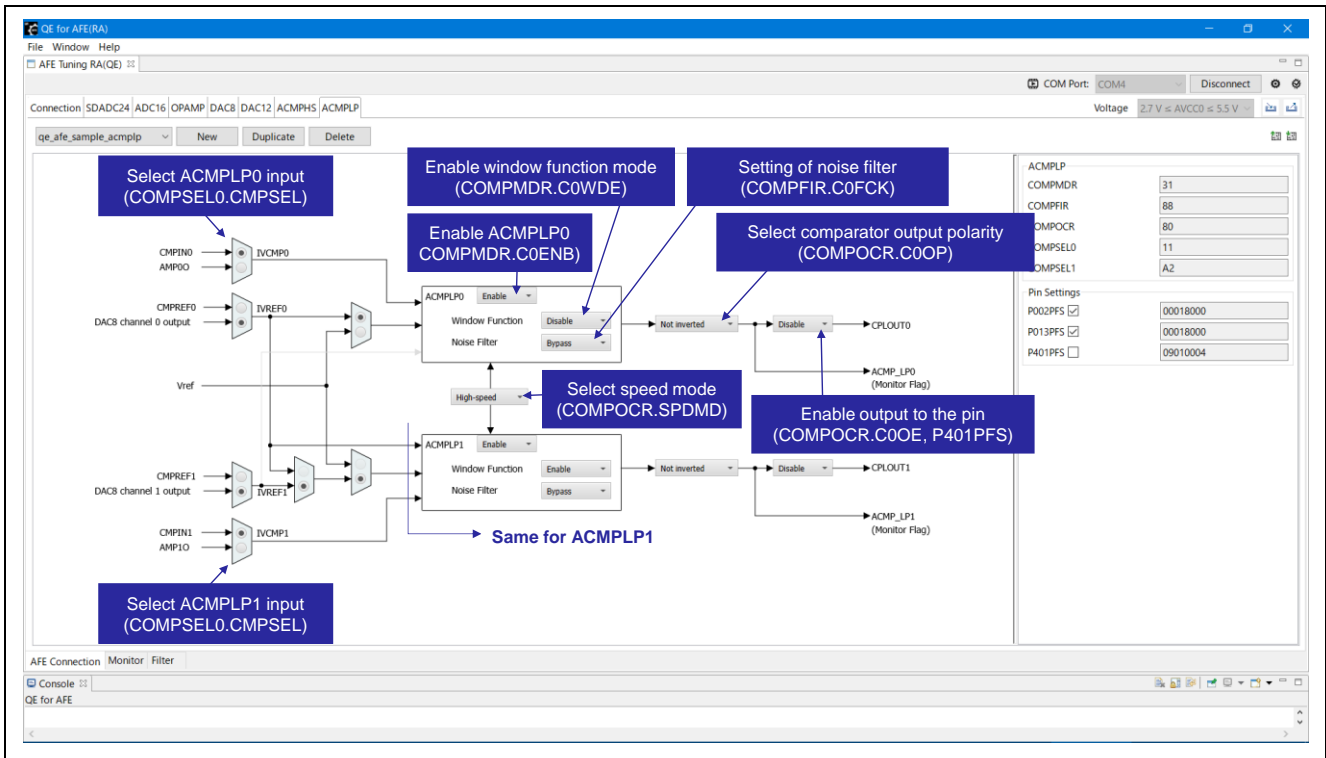


Figure 5-31 AFE Connection: ACMLP Input / Output settings

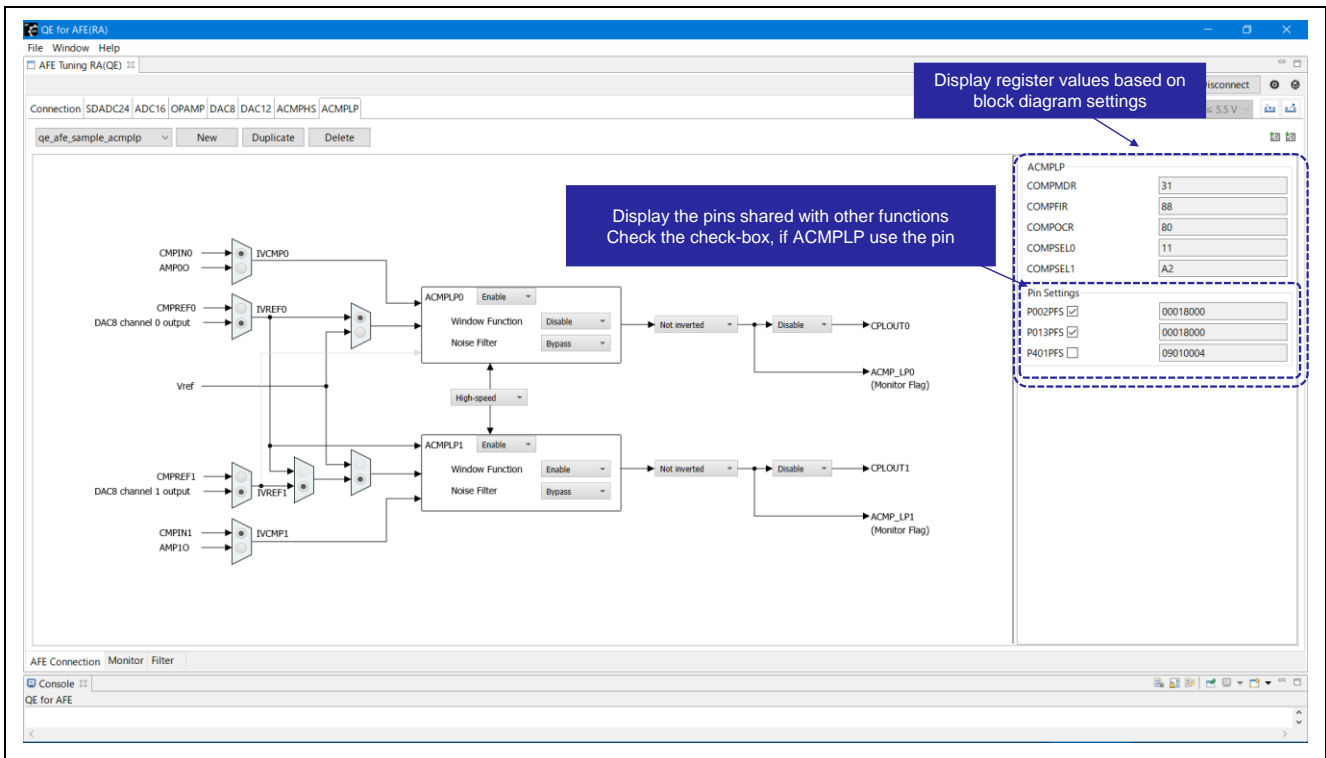


Figure 5-32 AFE Connection: ACMLP register settings



## 5.2 Monitor

By selecting the “Monitor” tab at the bottom of the QE for AFE, it is possible to obtain the A/D conversion value from the target board, and displays the waveform and histogram. Output signal from the comparator can also be displayed as waveform in here.

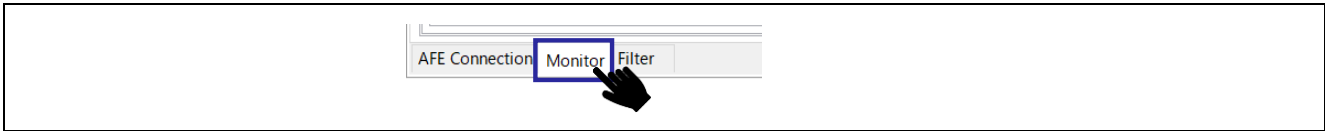


Figure 5-33 Selecting of “Monitor” tab

### 5.2.1 Common functions

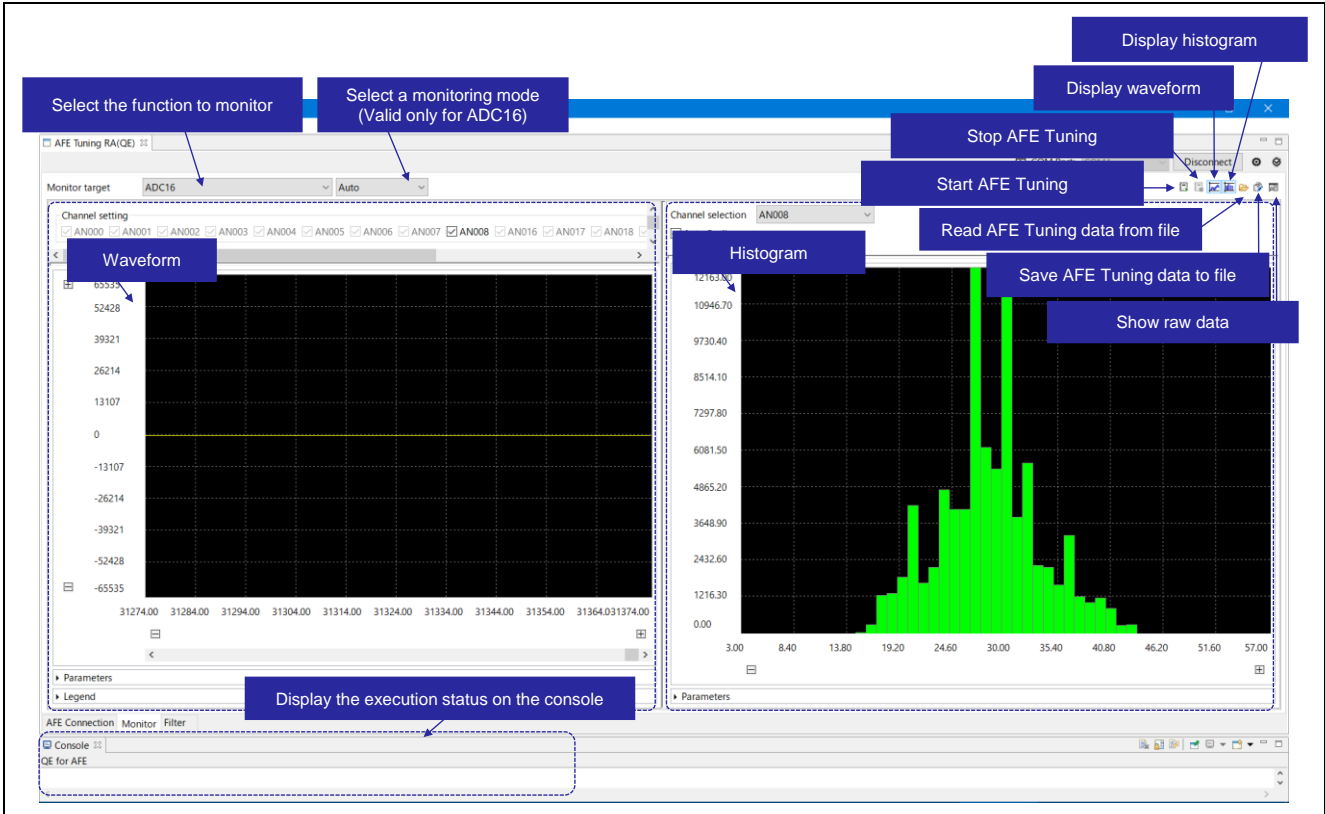
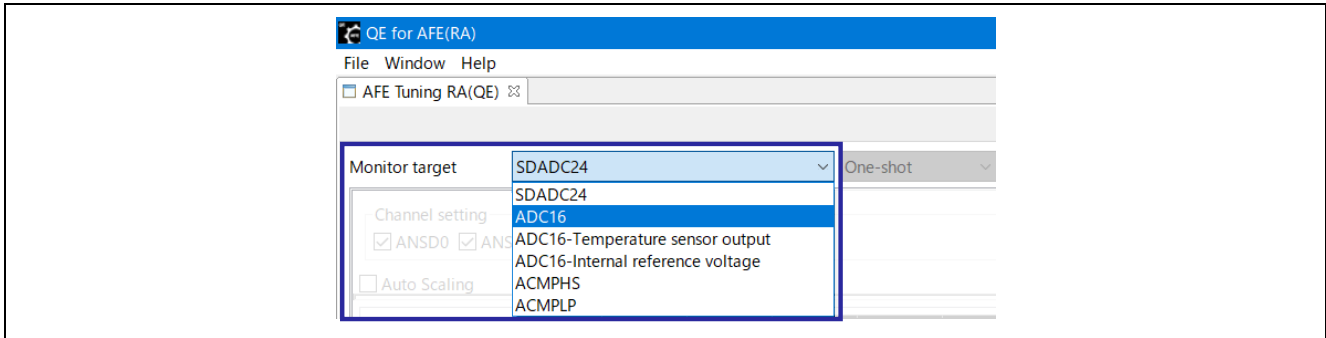


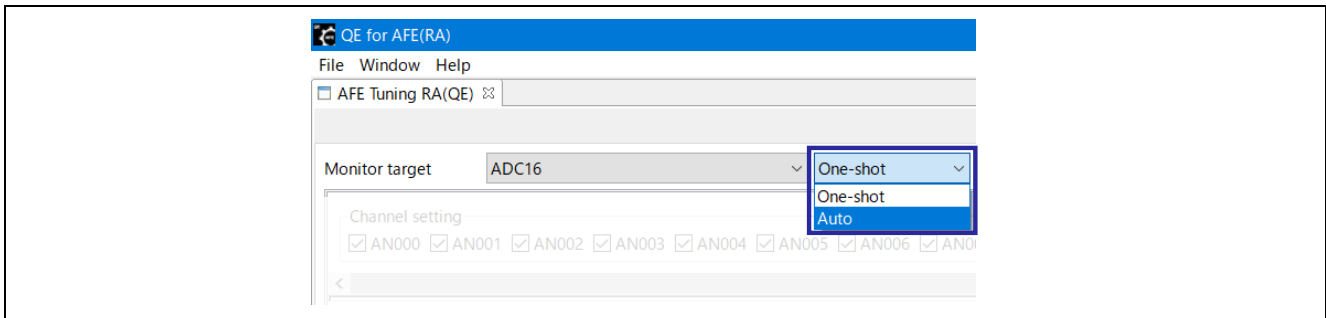
Figure 5-34 Monitor: Common functions

- Selecting of function to be monitored  
Select the analog function to be monitored from the pull-down menu as follows.



**Figure 5-35 Monitor: selecting of function to be monitored**








- Selecting of the monitoring mode  
When selecting ADC16 as monitoring function, the monitoring mode can be selected from pull-down menu as follows.



**Figure 5-36 Monitor: selecting of the monitoring mode**

- One-shot : AFE tuning will stop when the buffer on the target board is full. This mode can be selected only for ADC16.
- Auto : AFE tuning will continuously perform up to 1 hour. Except for ADC16, it always operates in this mode.

Table 5-3 Monitor: Common functions

Icons	Description	Condition		
		Before connection	After connection	
			STOP	Running
	Start AFE tuning. The maximum tuning time is 1 hour.		✓	
	Stop AFE tuning.			✓
	Obtains the AFE tuning result from the target board and displays the waveform. To stop the waveform display, click this icon again. For the waveform, refer to "5.2.2 Display of the waveform".	✓	✓	✓
	Obtains the AFE tuning result from the target board and displays the histogram with the A/D conversion value as the population. To stop the histogram display, click this icon again. For the histogram, refer to "5.2.3 Display of the histogram".	✓	✓	✓
	Read the saved AFE tuning data file. The AFE tuning data before reading the saved data will be discarded by this operation. The extension of the AFE tuning data file is ".dat", and the file can be saved to any location.	✓	✓	
	Save the retained AFE tuning data to the file as binary data. The extension of the AFE tuning data file is ".dat", and the file can be saved to any location.	✓	✓	
	List the raw data. The channel to be displayed in the list can be switched. To exit the list to display, click the "x" at the top right of the window. For the display of the list, refer to "5.2.4 Display of raw data"	✓	✓	

### 5.2.2 Display of the waveform

By clicking the icon below, the A/D conversion value can be displayed as a waveform.

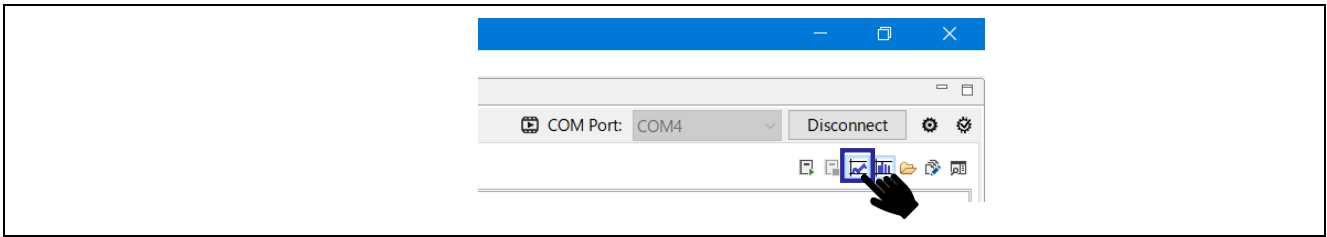


Figure 5-37 Monitor: Waveform display icon

The X-axis shows the time, and Y-axis shows the conversion value. The display range can be set with parameters for both the X-axis and Y-axis.

A/D conversion values can be listed as raw data. For the display of the list, refer to “5.2.4 Display of raw data”.

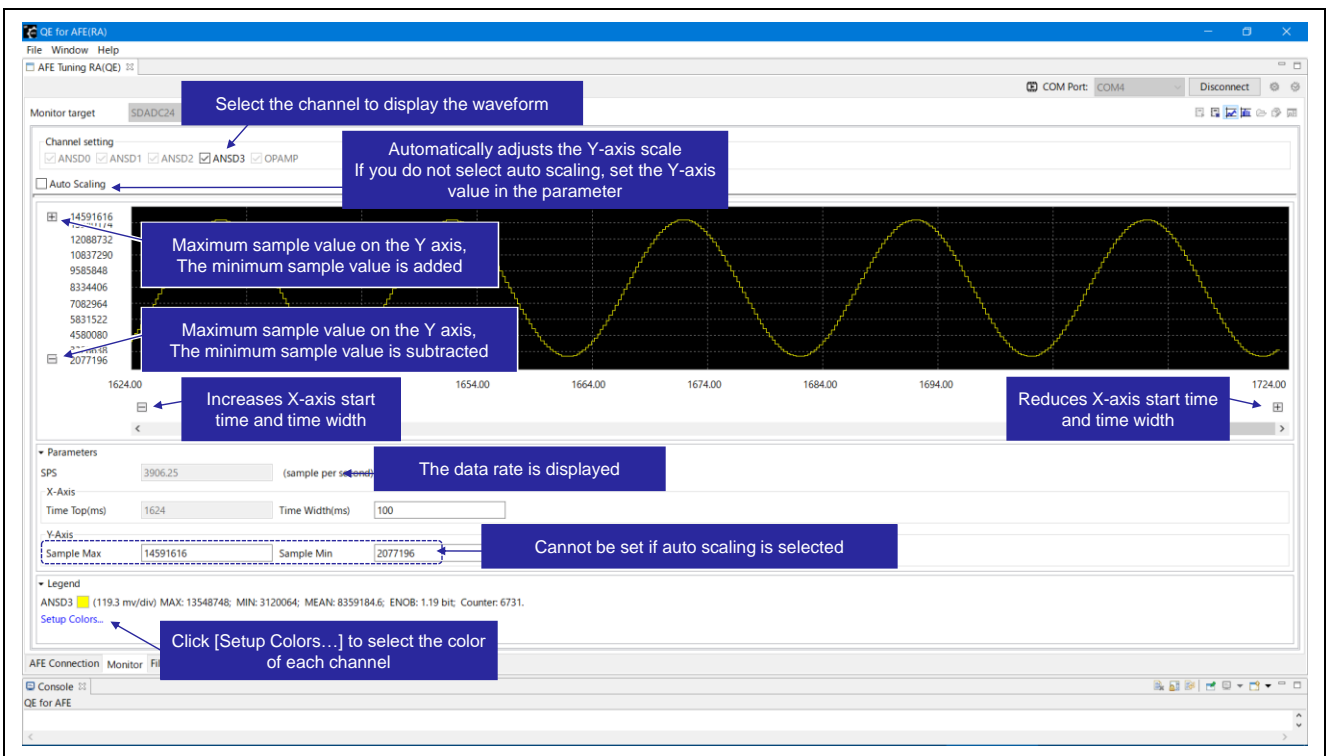


Figure 5-38 Monitor: Display of waveform

### 5.2.3 Display of the histogram

By clicking the icon below, a histogram with the A/D conversion value of the selected channel as the population.

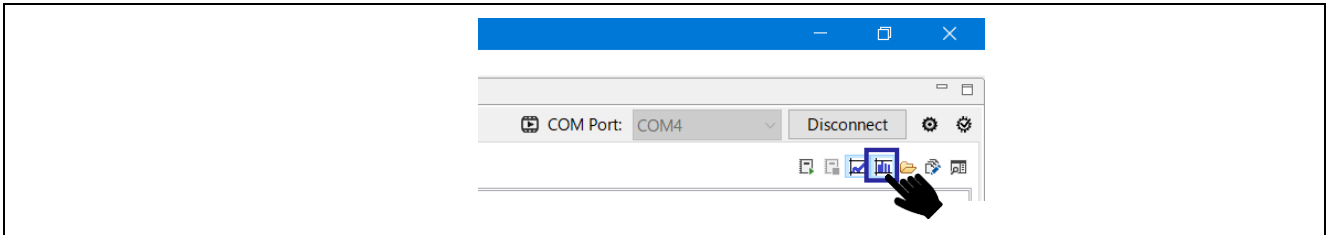


Figure 5-39 Monitor: Histogram display icon

The X-axis shows the A/D conversion value and the Y-axis shows the frequency. The display range of the X-axis can be set with parameters. The Y-axis is displayed in the range from 0 to maximum frequency.

The values for each class can be listed as raw data. For the list display, refer to "5.2.4 Display of raw data".

By clicking both waveform display icon and histogram display icon, it is possible to display both waveform and histogram at the same time. See Figure 5-34 for the image of display.

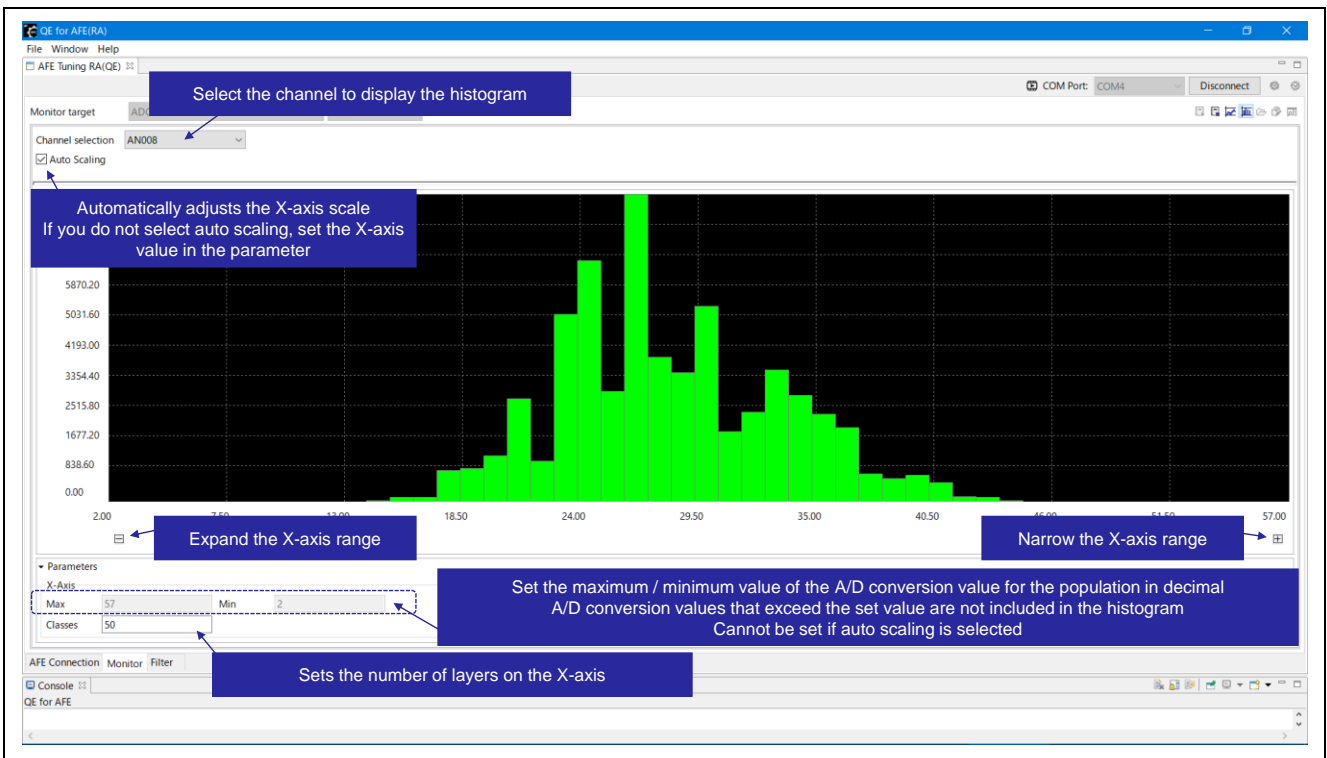
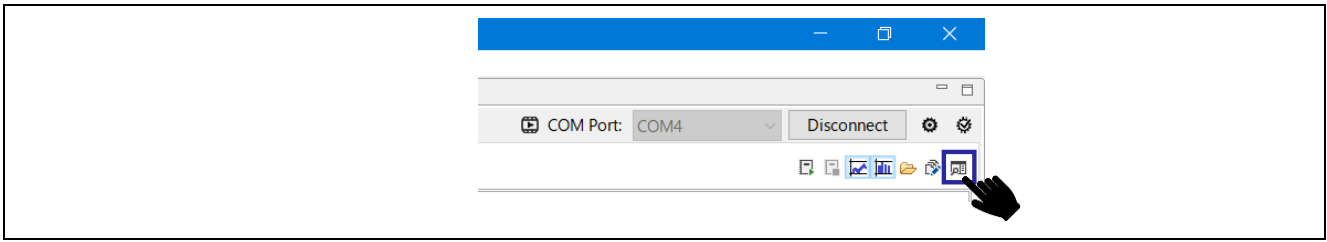


Figure 5-40 Monitor: Display of histogram

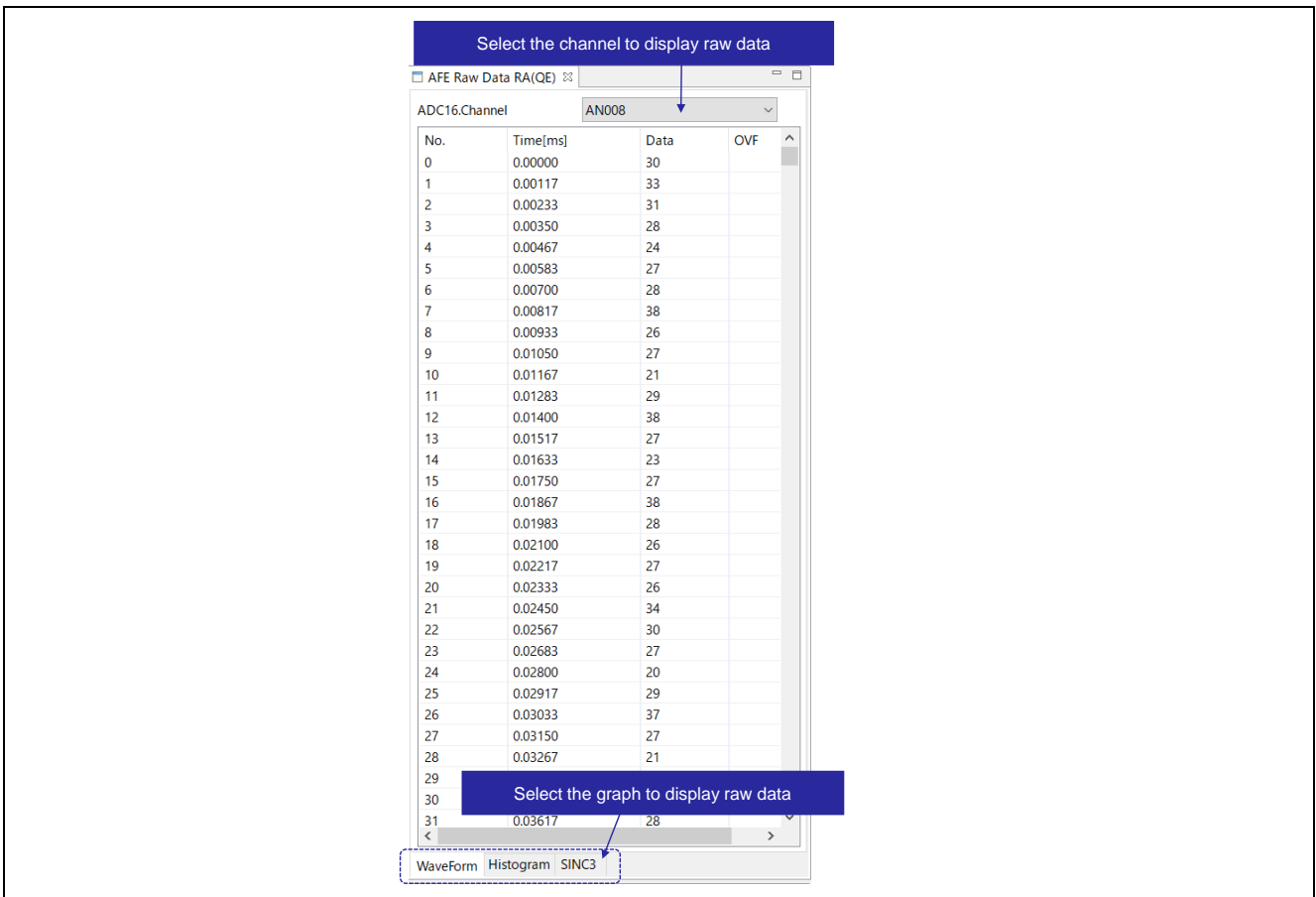
**5.2.4 Display of raw data**

By clicking the icon below, the values of the graph can be listed.



**Figure 5-41 Monitor: Raw data listing icon**

The list can be selected in a range and copied in CSV format. The copy can be done with “CTRL+C”.



**Figure 5-42 Monitor: Display of raw data**

### 5.3 Filter

By selecting the “Filter” tab, the auxiliary settings for AFE connections can be configured.



Figure 5-43 Selecting of “Filter” tab

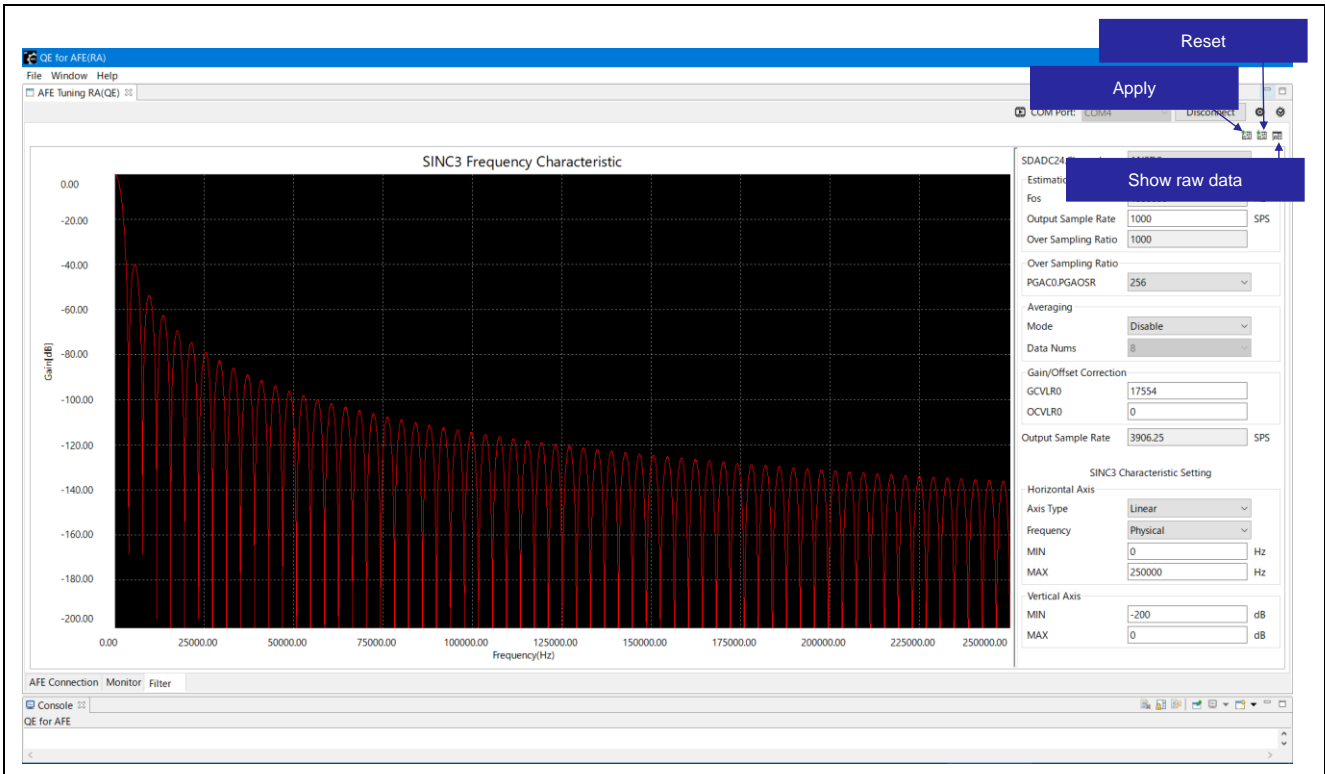


Figure 5-44 Filter: Screen of display

Table 5-4 Filter functions

Icons	Description	Condition		
		Before connection	After connection	
			STOP	Running
	Apply each parameter of the filter to the register value on the AFE Connection tab.	✓	✓	
	Reset each parameter of the filter to the setting based on the register value on the AFE Connection tab.	✓	✓	
	Gain for each frequency can be listed as raw data. For the display of the list, refer to “5.2.4 Display of raw data”.	✓	✓	✓

### 5.3.1 Frequency characteristics of SINC3

It is possible to set the SINC3 filter related register, and to display the frequency-gain characteristic graph based on the settings.

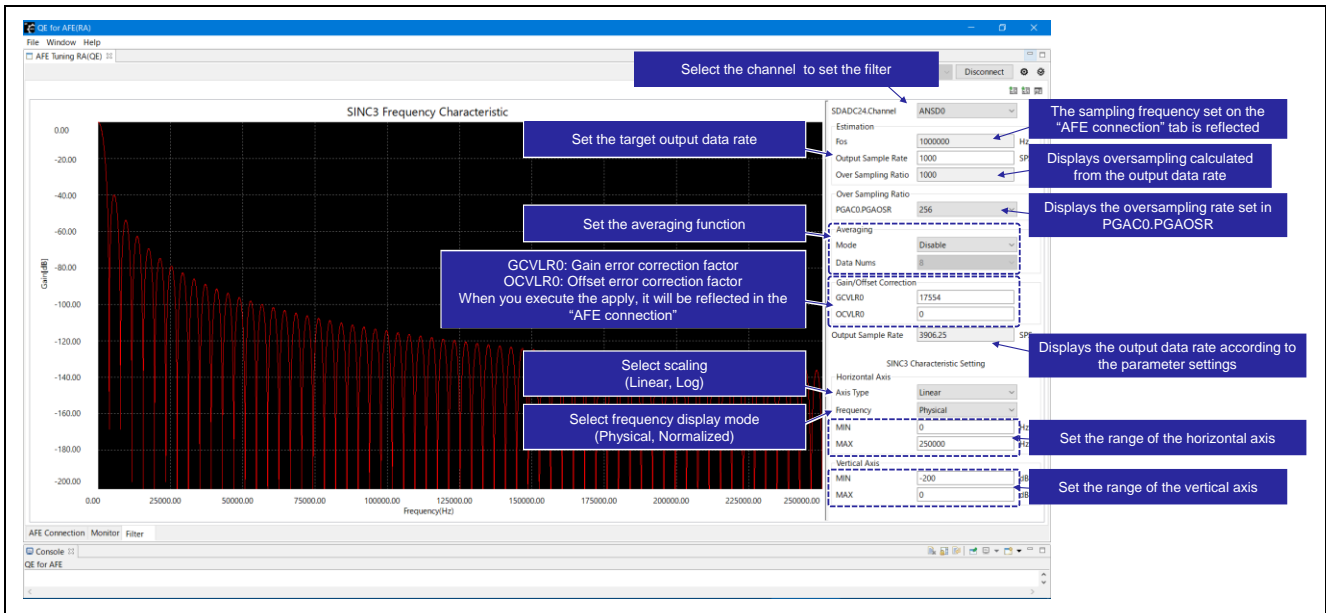
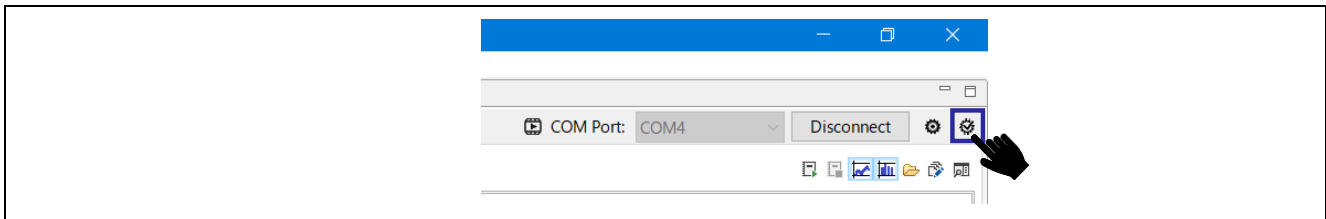


Figure 5-45 Filter: Frequency characteristics of SINC3



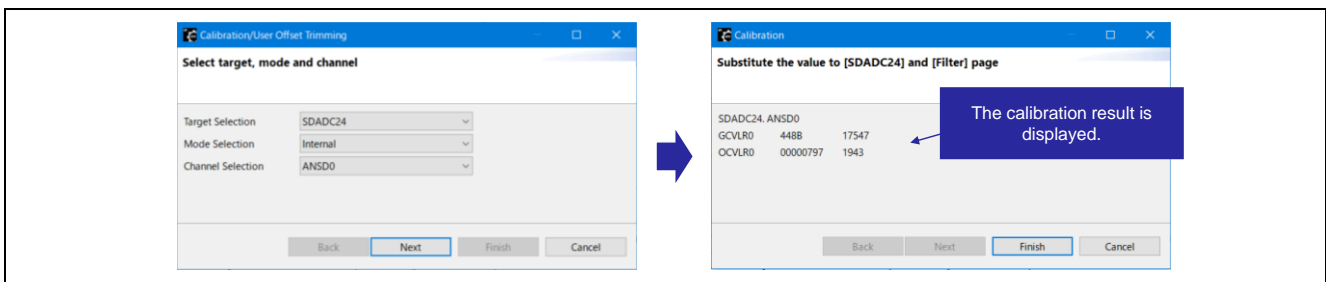
### 5.4 Calibration

After connecting the QE for AFE to the target board, by clicking the icon below, the calibration of analog characteristic can be done.



**Figure 5-46 Calibration icon**

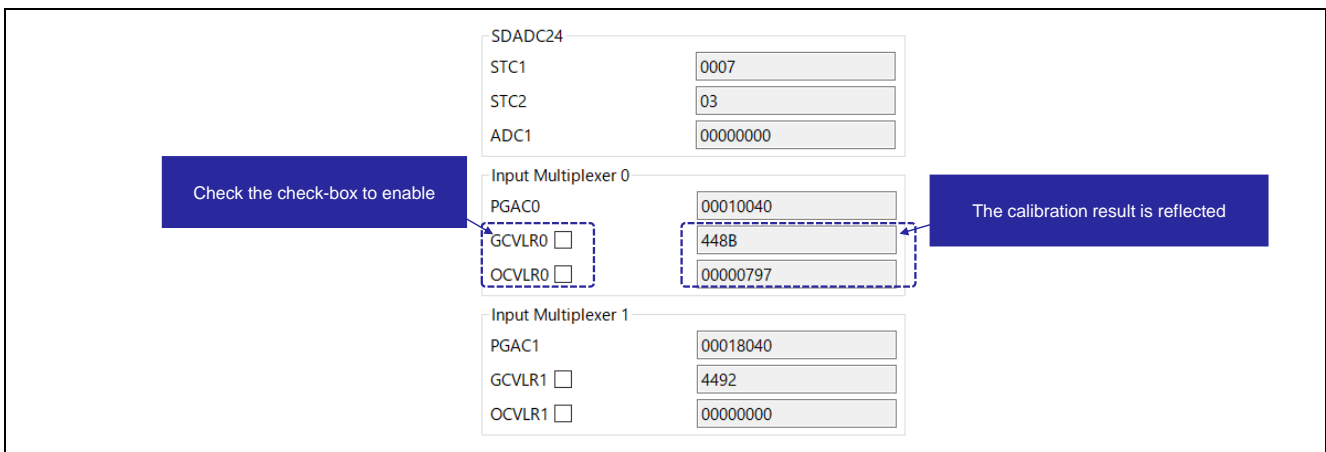
The calibration can be done for each channel. After selecting the function and channel to perform calibration, click “Next” to display the calibration result as shown below.



**Figure 5-47 Display of calibration result**

Click “Finish” to reflect the register values in SINC3 and AFE Connections.

To reflect the calibration result to related registers, check the checkbox of the register to be calibrated in “AFE connection”, and make sure to write to RA2A1 on the target board.



**Figure 5-48 Calibration: Reflection to the AFE connection register value**

**Revision History**

Rev.	Date	Description	
		Page	Summary
1.00	Aug.20.21	-	First edition

## General Precautions in the Handling of Microprocessing Unit and Microcontroller Unit Products

The following usage notes are applicable to all Microprocessing unit and Microcontroller unit products from Renesas. For detailed usage notes on the products covered by this document, refer to the relevant sections of the document as well as any technical updates that have been issued for the products.

### 1. Precaution against Electrostatic Discharge (ESD)

A strong electrical field, when exposed to a CMOS device, can cause destruction of the gate oxide and ultimately degrade the device operation. Steps must be taken to stop the generation of static electricity as much as possible, and quickly dissipate it when it occurs. Environmental control must be adequate. When it is dry, a humidifier should be used. This is recommended to avoid using insulators that can easily build up static electricity.

Semiconductor devices must be stored and transported in an anti-static container, static shielding bag or conductive material. All test and measurement tools including work benches and floors must be grounded. The operator must also be grounded using a wrist strap. Semiconductor devices must not be touched with bare hands. Similar precautions must be taken for printed circuit boards with mounted semiconductor devices.

### 2. Processing at power-on

The state of the product is undefined at the time when power is supplied. The states of internal circuits in the LSI are indeterminate and the states of register settings and pins are undefined at the time when power is supplied. In a finished product where the reset signal is applied to the external reset pin, the states of pins are not guaranteed from the time when power is supplied until the reset process is completed. In a similar way, the states of pins in a product that is reset by an on-chip power-on reset function are not guaranteed from the time when power is supplied until the power reaches the level at which resetting is specified.

### 3. Input of signal during power-off state

Do not input signals or an I/O pull-up power supply while the device is powered off. The current injection that results from input of such a signal or I/O pull-up power supply may cause malfunction and the abnormal current that passes in the device at this time may cause degradation of internal elements. Follow the guideline for input signal during power-off state as described in your product documentation.

### 4. Handling of unused pins

Handle unused pins in accordance with the directions given under handling of unused pins in the manual. The input pins of CMOS products are generally in the high-impedance state. In operation with an unused pin in the open-circuit state, extra electromagnetic noise is induced in the vicinity of the LSI, an associated shoot-through current flows internally, and malfunctions occur due to the false recognition of the pin state as an input signal become possible.

### 5. Clock signals

After applying a reset, only release the reset line after the operating clock signal becomes stable. When switching the clock signal during program execution, wait until the target clock signal is stabilized. When the clock signal is generated with an external resonator or from an external oscillator during a reset, ensure that the reset line is only released after full stabilization of the clock signal. Additionally, when switching to a clock signal produced with an external resonator or by an external oscillator while program execution is in progress, wait until the target clock signal is stable.

### 6. Voltage application waveform at input pin

Waveform distortion due to input noise or a reflected wave may cause malfunction. If the input of the CMOS device stays in the area between  $V_{IL}$  (Max.) and  $V_{IH}$  (Min.) due to noise, for example, the device may malfunction. Take care to prevent chattering noise from entering the device when the input level is fixed, and also in the transition period when the input level passes through the area between  $V_{IL}$  (Max.) and  $V_{IH}$  (Min.).

### 7. Prohibition of access to reserved addresses

Access to reserved addresses is prohibited. The reserved addresses are provided for possible future expansion of functions. Do not access these addresses as the correct operation of the LSI is not guaranteed.

### 8. Differences between products

Before changing from one product to another, for example to a product with a different part number, confirm that the change will not lead to problems. The characteristics of a microprocessing unit or microcontroller unit products in the same group but having a different part number might differ in terms of internal memory capacity, layout pattern, and other factors, which can affect the ranges of electrical characteristics, such as characteristic values, operating margins, immunity to noise, and amount of radiated noise. When changing to a product with a different part number, implement a system-evaluation test for the given product.

## Notice

1. Descriptions of circuits, software and other related information in this document are provided only to illustrate the operation of semiconductor products and application examples. You are fully responsible for the incorporation or any other use of the circuits, software, and information in the design of your product or system. Renesas Electronics disclaims any and all liability for any losses and damages incurred by you or third parties arising from the use of these circuits, software, or information.
2. Renesas Electronics hereby expressly disclaims any warranties against and liability for infringement or any other claims involving patents, copyrights, or other intellectual property rights of third parties, by or arising from the use of Renesas Electronics products or technical information described in this document, including but not limited to, the product data, drawings, charts, programs, algorithms, and application examples.
3. No license, express, implied or otherwise, is granted hereby under any patents, copyrights or other intellectual property rights of Renesas Electronics or others.
4. You shall be responsible for determining what licenses are required from any third parties, and obtaining such licenses for the lawful import, export, manufacture, sales, utilization, distribution or other disposal of any products incorporating Renesas Electronics products, if required.
5. You shall not alter, modify, copy, or reverse engineer any Renesas Electronics product, whether in whole or in part. Renesas Electronics disclaims any and all liability for any losses or damages incurred by you or third parties arising from such alteration, modification, copying or reverse engineering.
6. Renesas Electronics products are classified according to the following two quality grades: "Standard" and "High Quality". The intended applications for each Renesas Electronics product depends on the product's quality grade, as indicated below.
  - "Standard": Computers; office equipment; communications equipment; test and measurement equipment; audio and visual equipment; home electronic appliances; machine tools; personal electronic equipment; industrial robots; etc.
  - "High Quality": Transportation equipment (automobiles, trains, ships, etc.); traffic control (traffic lights); large-scale communication equipment; key financial terminal systems; safety control equipment; etc.Unless expressly designated as a high reliability product or a product for harsh environments in a Renesas Electronics data sheet or other Renesas Electronics document, Renesas Electronics products are not intended or authorized for use in products or systems that may pose a direct threat to human life or bodily injury (artificial life support devices or systems; surgical implantations; etc.), or may cause serious property damage (space system; undersea repeaters; nuclear power control systems; aircraft control systems; key plant systems; military equipment; etc.). Renesas Electronics disclaims any and all liability for any damages or losses incurred by you or any third parties arising from the use of any Renesas Electronics product that is inconsistent with any Renesas Electronics data sheet, user's manual or other Renesas Electronics document.
7. No semiconductor product is absolutely secure. Notwithstanding any security measures or features that may be implemented in Renesas Electronics hardware or software products, Renesas Electronics shall have absolutely no liability arising out of any vulnerability or security breach, including but not limited to any unauthorized access to or use of a Renesas Electronics product or a system that uses a Renesas Electronics product. RENESAS ELECTRONICS DOES NOT WARRANT OR GUARANTEE THAT RENESAS ELECTRONICS PRODUCTS, OR ANY SYSTEMS CREATED USING RENESAS ELECTRONICS PRODUCTS WILL BE INVULNERABLE OR FREE FROM CORRUPTION, ATTACK, VIRUSES, INTERFERENCE, HACKING, DATA LOSS OR THEFT, OR OTHER SECURITY INTRUSION ("Vulnerability Issues"). RENESAS ELECTRONICS DISCLAIMS ANY AND ALL RESPONSIBILITY OR LIABILITY ARISING FROM OR RELATED TO ANY VULNERABILITY ISSUES. FURTHERMORE, TO THE EXTENT PERMITTED BY APPLICABLE LAW, RENESAS ELECTRONICS DISCLAIMS ANY AND ALL WARRANTIES, EXPRESS OR IMPLIED, WITH RESPECT TO THIS DOCUMENT AND ANY RELATED OR ACCOMPANYING SOFTWARE OR HARDWARE, INCLUDING BUT NOT LIMITED TO THE IMPLIED WARRANTIES OF MERCHANTABILITY, OR FITNESS FOR A PARTICULAR PURPOSE.
8. When using Renesas Electronics products, refer to the latest product information (data sheets, user's manuals, application notes, "General Notes for Handling and Using Semiconductor Devices" in the reliability handbook, etc.), and ensure that usage conditions are within the ranges specified by Renesas Electronics with respect to maximum ratings, operating power supply voltage range, heat dissipation characteristics, installation, etc. Renesas Electronics disclaims any and all liability for any malfunctions, failure or accident arising out of the use of Renesas Electronics products outside of such specified ranges.
9. Although Renesas Electronics endeavors to improve the quality and reliability of Renesas Electronics products, semiconductor products have specific characteristics, such as the occurrence of failure at a certain rate and malfunctions under certain use conditions. Unless designated as a high reliability product or a product for harsh environments in a Renesas Electronics data sheet or other Renesas Electronics document, Renesas Electronics products are not subject to radiation resistance design. You are responsible for implementing safety measures to guard against the possibility of bodily injury, injury or damage caused by fire, and/or danger to the public in the event of a failure or malfunction of Renesas Electronics products, such as safety design for hardware and software, including but not limited to redundancy, fire control and malfunction prevention, appropriate treatment for aging degradation or any other appropriate measures. Because the evaluation of microcomputer software alone is very difficult and impractical, you are responsible for evaluating the safety of the final products or systems manufactured by you.
10. Please contact a Renesas Electronics sales office for details as to environmental matters such as the environmental compatibility of each Renesas Electronics product. You are responsible for carefully and sufficiently investigating applicable laws and regulations that regulate the inclusion or use of controlled substances, including without limitation, the EU RoHS Directive, and using Renesas Electronics products in compliance with all these applicable laws and regulations. Renesas Electronics disclaims any and all liability for damages or losses occurring as a result of your noncompliance with applicable laws and regulations.
11. Renesas Electronics products and technologies shall not be used for or incorporated into any products or systems whose manufacture, use, or sale is prohibited under any applicable domestic or foreign laws or regulations. You shall comply with any applicable export control laws and regulations promulgated and administered by the governments of any countries asserting jurisdiction over the parties or transactions.
12. It is the responsibility of the buyer or distributor of Renesas Electronics products, or any other party who distributes, disposes of, or otherwise sells or transfers the product to a third party, to notify such third party in advance of the contents and conditions set forth in this document.
13. This document shall not be reprinted, reproduced or duplicated in any form, in whole or in part, without prior written consent of Renesas Electronics.
14. Please contact a Renesas Electronics sales office if you have any questions regarding the information contained in this document or Renesas Electronics products.

(Note1) "Renesas Electronics" as used in this document means Renesas Electronics Corporation and also includes its directly or indirectly controlled subsidiaries.

(Note2) "Renesas Electronics product(s)" means any product developed or manufactured by or for Renesas Electronics.

(Rev.5.0-1 October 2020)

## Corporate Headquarters

TOYOSU FORESIA, 3-2-24 Toyosu,  
Koto-ku, Tokyo 135-0061, Japan  
[www.renesas.com](http://www.renesas.com)

## Trademarks

Renesas and the Renesas logo are trademarks of Renesas Electronics Corporation. All trademarks and registered trademarks are the property of their respective owners.

## Contact information

For further information on a product, technology, the most up-to-date version of a document, or your nearest sales office, please visit:  
[www.renesas.com/contact/](http://www.renesas.com/contact/).