

BCR12CM-16LB

800V - 12A - Triac

Medium Power Use

R07DS0976EJ0300

Rev.3.00

Feb. 1, 2019

Features

- $I_T (RMS)$: 12 A
- V_{DRM} : 800 V
- I_{FGT} , I_{RGT} , $I_{RGT III}$: 30 mA
- T_j : 150°C
- Non-insulated Type
- Planar Passivation Type

Outline

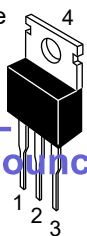
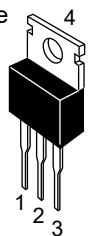
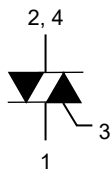
<p>RENESAS Package code: PRSS0004AG-A (Package name: TO-220AB) Ordering code #BB0</p>  <p>EOL announced</p>	<p>RENESAS Package code: PRSS0004AT-A (Package name: TO-220ABA) Ordering code #BH0</p> 	 <p>1. T₁ Terminal 2. T₂ Terminal 3. Gate Terminal 4. T₂ Terminal</p>
---	--	---

Application

Power supply, motor control, heater control and other general purpose AC control applications.

Maximum Ratings

Parameter	Symbol	Voltage class	
		16	Unit
Repetitive peak off-state voltage ^{Note1}	V_{DRM}	800	V
Non-repetitive peak off-state voltage ^{Note1}	V_{DSM}	960	V

Parameter	Symbol	Ratings	Unit	Conditions
RMS on-state current	$I_T (RMS)$	12	A	Commercial frequency, sine full wave 360° conduction, $T_c = 123^\circ C$ ^{Note3}
Surge on-state current	I_{TSM}	120	A	60 Hz sinewave 1 full cycle, peak value, non-repetitive
I^2t for fusion	I^2t	60	A ² s	Value corresponding to 1 cycle of half wave 60 Hz, surge on-state current
Peak gate power dissipation	P_{GM}	5	W	
Average gate power dissipation	$P_{G(AV)}$	0.5	W	
Peak gate voltage	V_{GM}	10	V	
Peak gate current	I_{GM}	2	A	
Junction Temperature	T_j	-40 to +150	°C	
Storage temperature	T_{stg}	-40 to +150	°C	

Electrical Characteristics

Parameter	Symbol	Min.	Typ.	Max.	Unit	Test conditions
Repetitive peak off-state current	I_{DRM}	—	—	2.0	mA	$T_j = 150^\circ\text{C}$, V_{DRM} applied
On-state voltage	V_{TM}	—	—	1.6	V	$T_c = 25^\circ\text{C}$, $I_{TM} = 20\text{ A}$, instantaneous measurement
Gate trigger voltage ^{Note2}	I	V_{FGTI}	—	—	1.5	$T_j = 25^\circ\text{C}$, $V_D = 6\text{ V}$, $R_L = 6\ \Omega$, $R_G = 330\ \Omega$
	II	V_{RGTI}	—	—	1.5	
	III	V_{RGTIII}	—	—	1.5	
Gate trigger current ^{Note2}	I	I_{FGTI}	—	—	30	$T_j = 25^\circ\text{C}$, $V_D = 6\text{ V}$, $R_L = 6\ \Omega$, $R_G = 330\ \Omega$
	II	I_{RGTI}	—	—	30	
	III	I_{RGTIII}	—	—	30	
Gate non-trigger voltage	V_{GD}	0.2	—	—	V	$T_j = 125^\circ\text{C}$, $V_D = 1/2 V_{DRM}$
		0.1	—	—	V	$T_j = 150^\circ\text{C}$, $V_D = 1/2 V_{DRM}$
Thermal resistance	$R_{th(j-c)}$	—	—	1.8	$^\circ\text{C/W}$	Junction to case ^{Note3 Note4}
Critical-rate of rise of off-state commutation voltage ^{Note5}	$(dv/dt)_c$	10	—	—	$\text{V}/\mu\text{s}$	$T_j = 125^\circ\text{C}$
		1	—	—	$\text{V}/\mu\text{s}$	$T_j = 150^\circ\text{C}$

Notes: 1. Gate open.

2. Measurement using the gate trigger characteristics measurement circuit.

3. Case temperature is measured at the T_2 tab 1.5 mm away from the molded case.

4. The contact thermal resistance $R_{th(c-f)}$ in case of greasing is 1.0°C/W .

5. Test conditions of the critical-rate of rise of off-state commutation voltage is shown in the table below.

Test conditions	Commutating voltage and current waveforms (inductive load)
1. Junction temperature $T_j = 125^\circ\text{C}/150^\circ\text{C}$ 2. Rate of decay of on-state commutating current $(di/dt)_c = -6\text{ A/ms}$ 3. Peak off-state voltage $V_D = 400\text{ V}$	

Performance Curves

Maximum On-State Characteristics

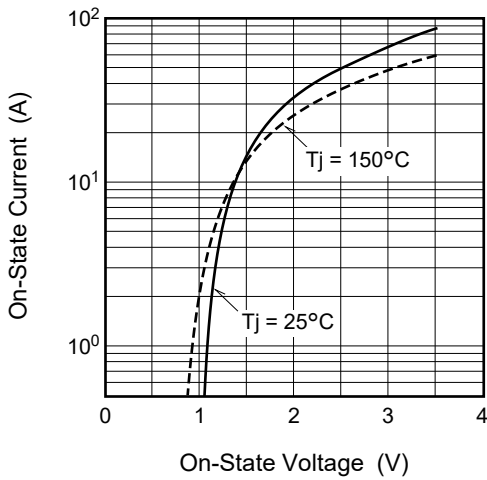

Rated Surge On-State Current

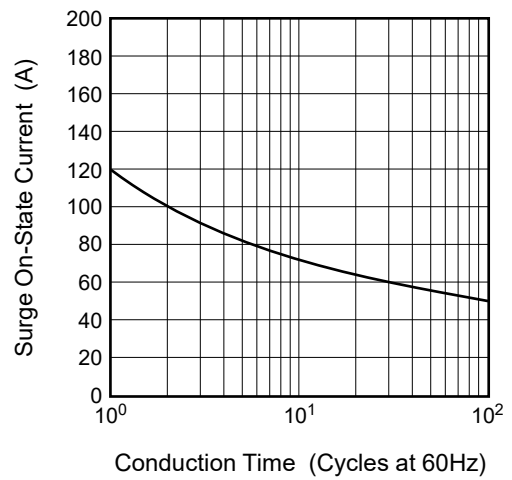

Gate Characteristics (I, II and III)

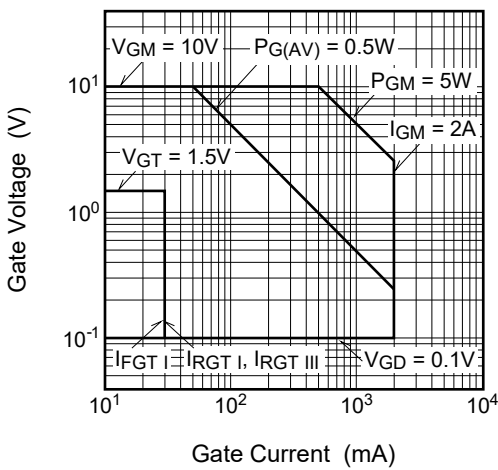

Gate Trigger Current vs. Junction Temperature

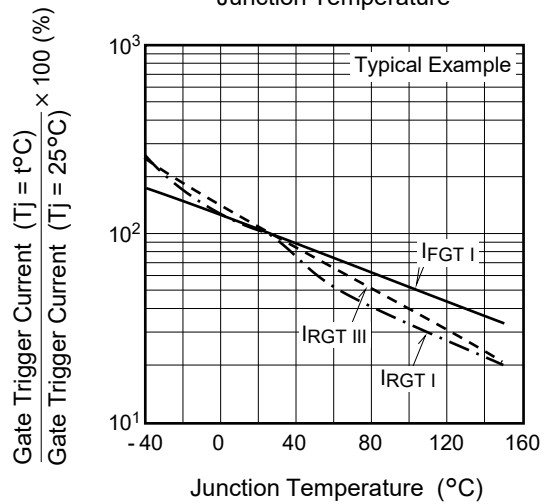

Gate Trigger Voltage vs. Junction Temperature

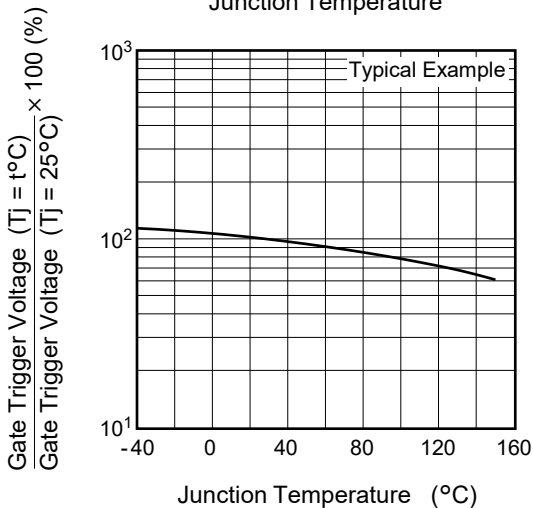

Gate Trigger Current vs. Gate Current Pulse Width

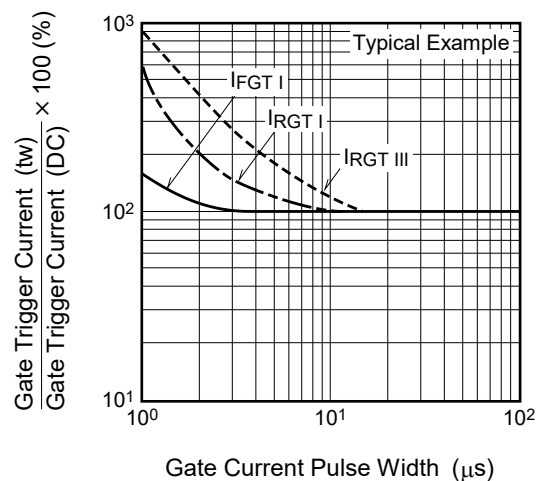

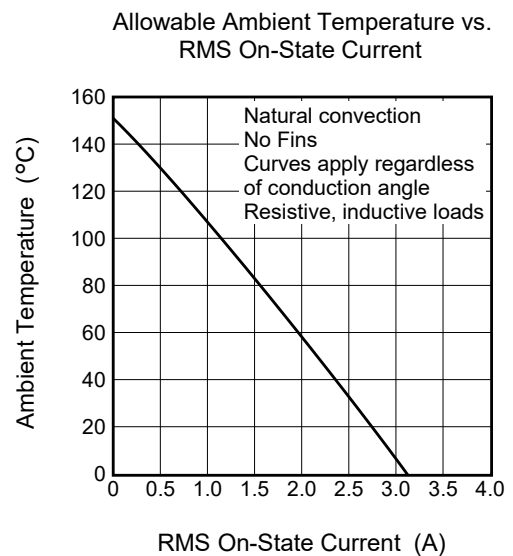
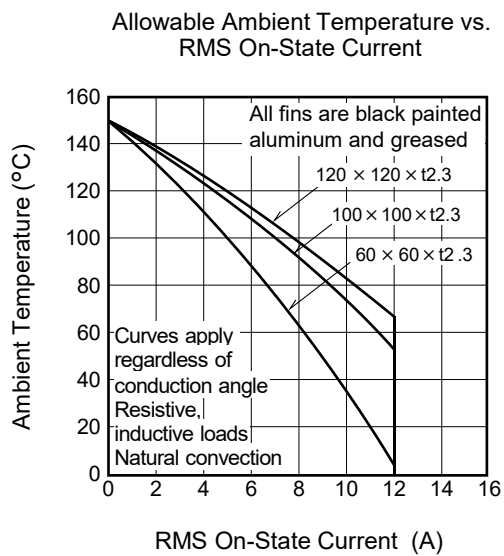
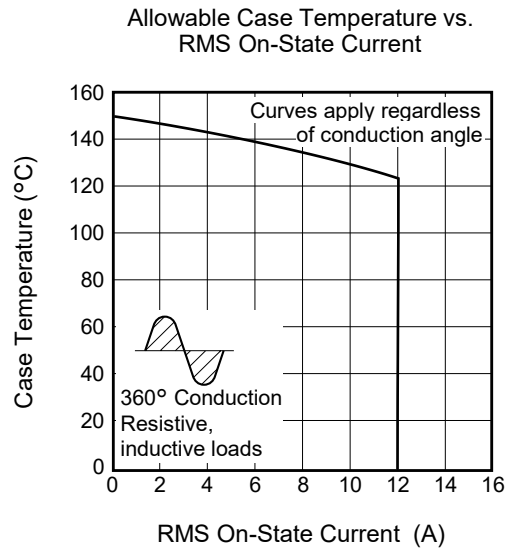
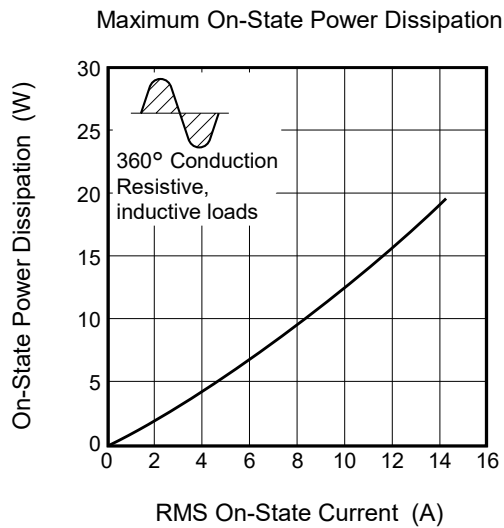
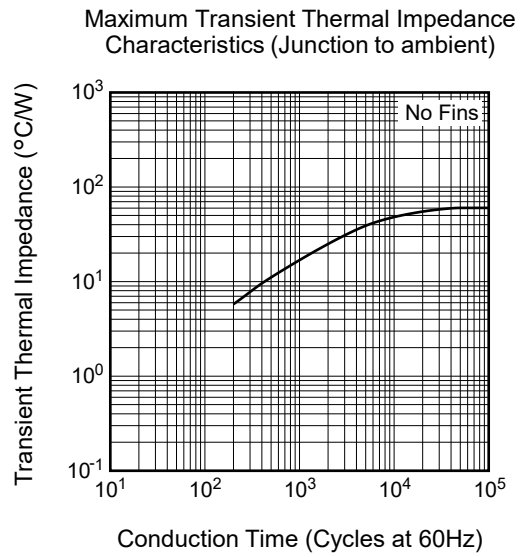
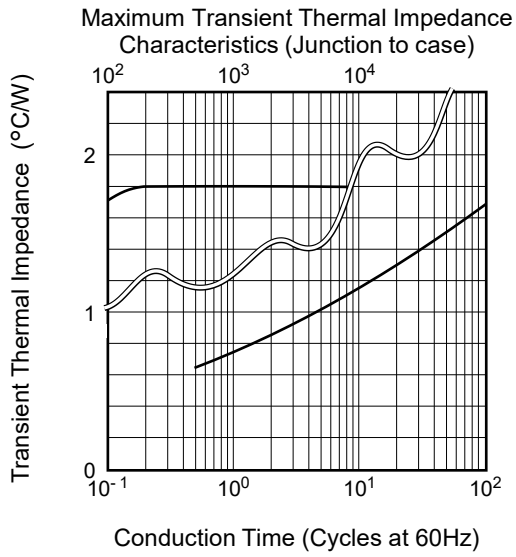

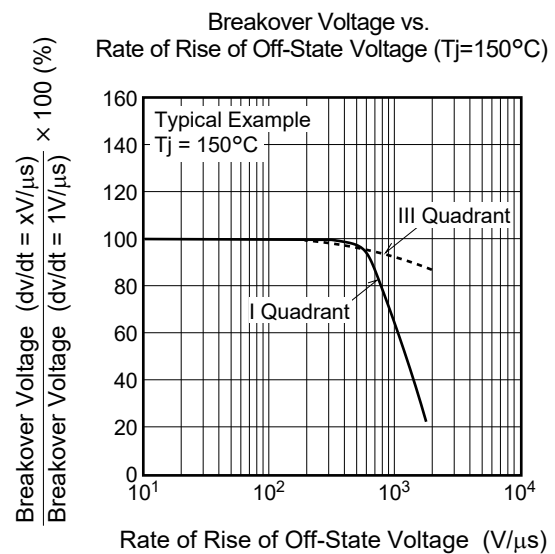
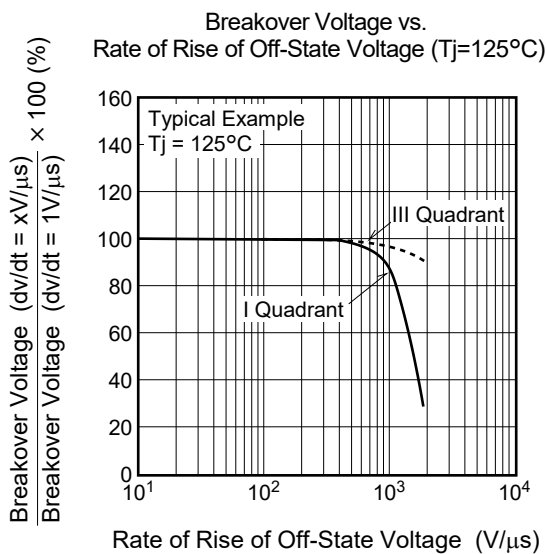
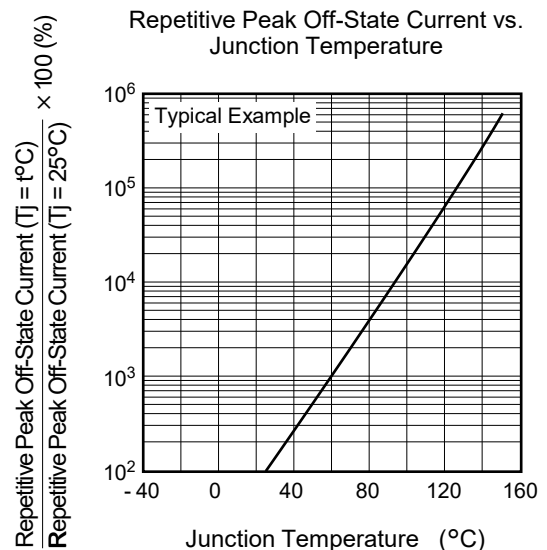
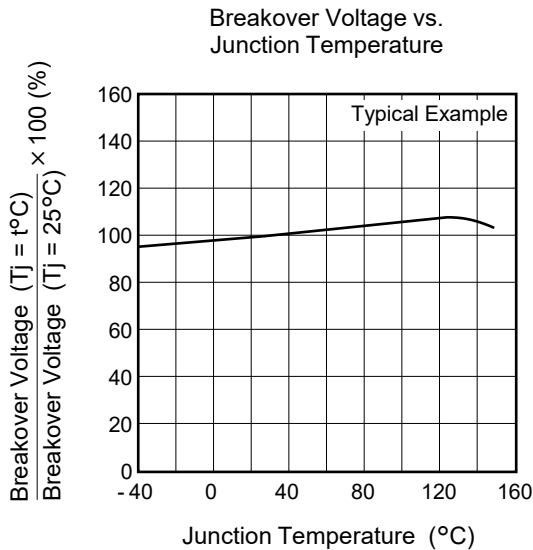
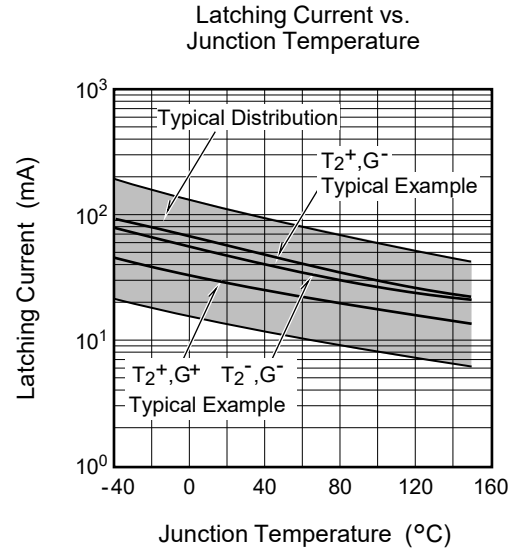
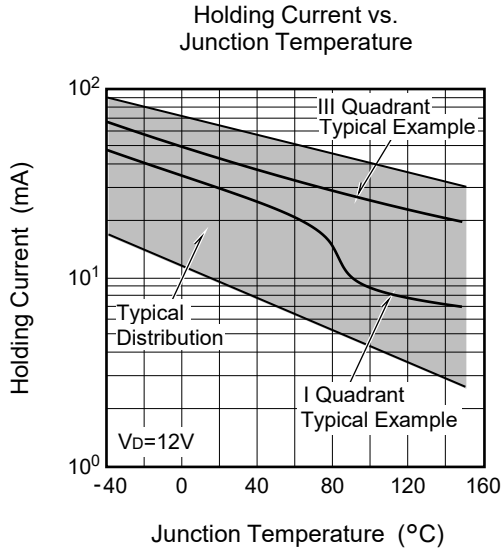

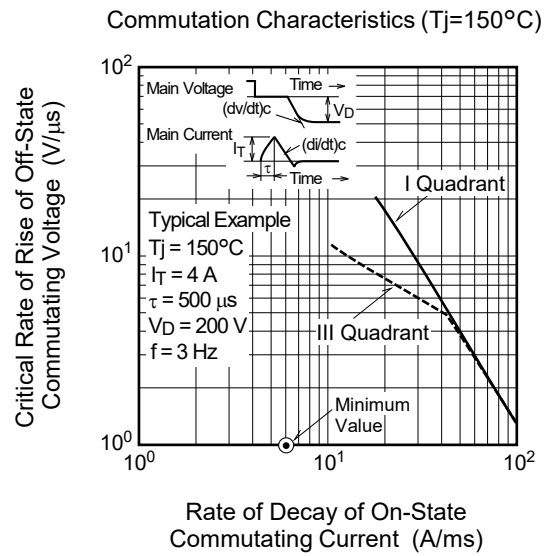
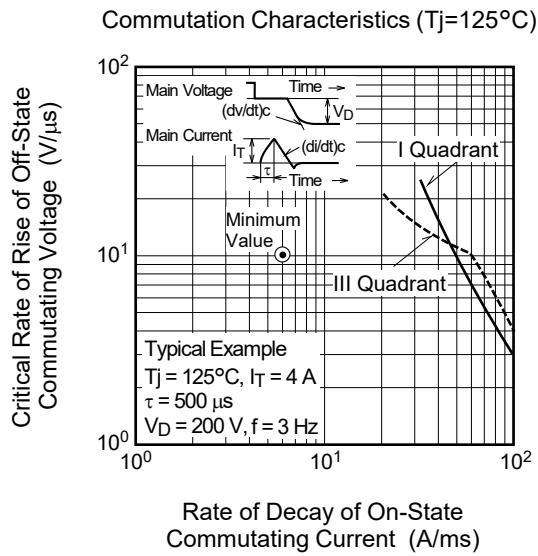

Gate Trigger Characteristics Test Circuits

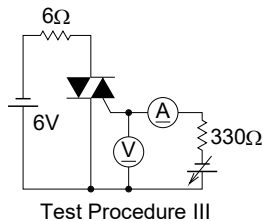
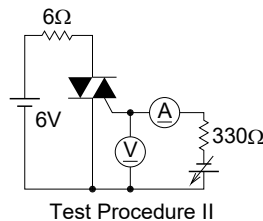
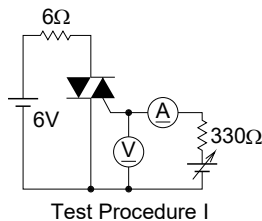

Recommended peripheral components for Triac

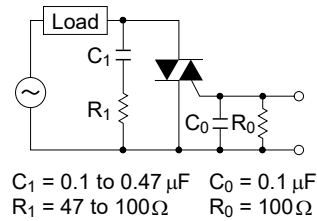

Package Dimensions

Ordering code: #BH0

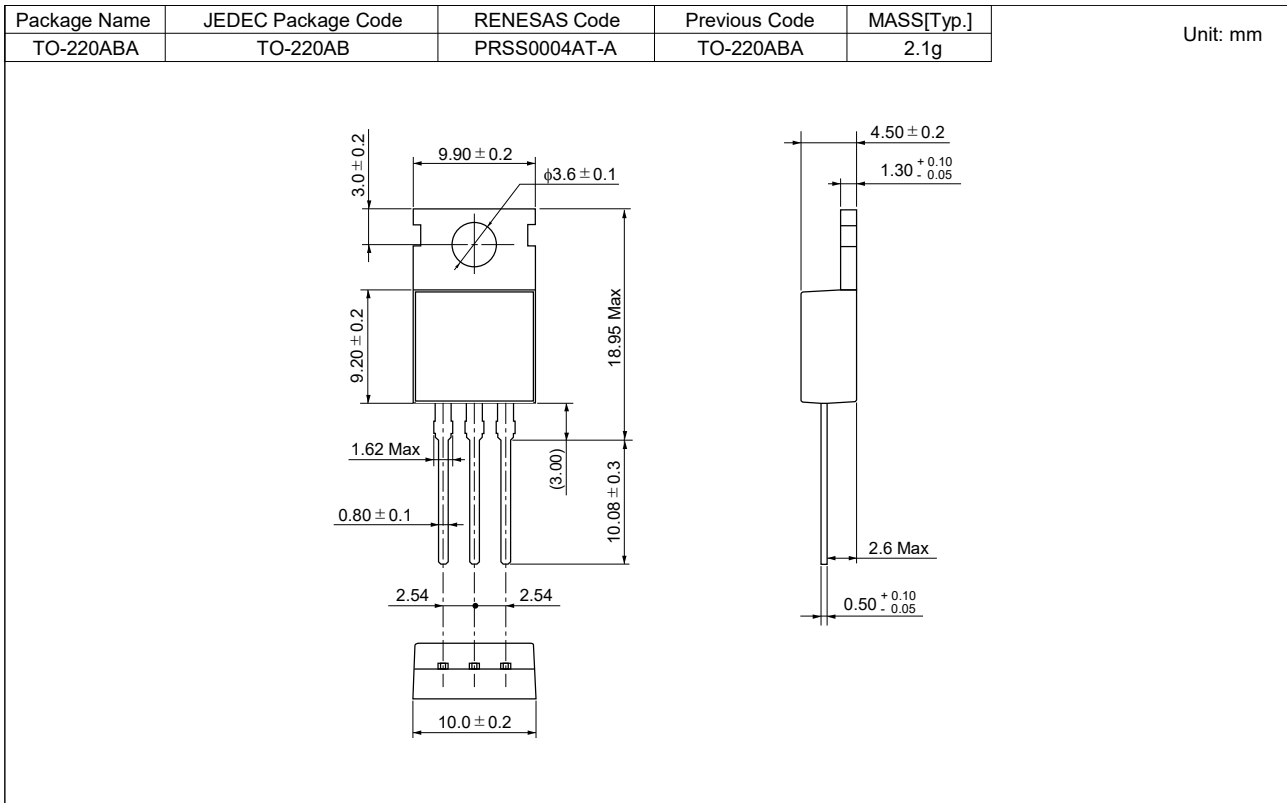

Ordering code: #BB0

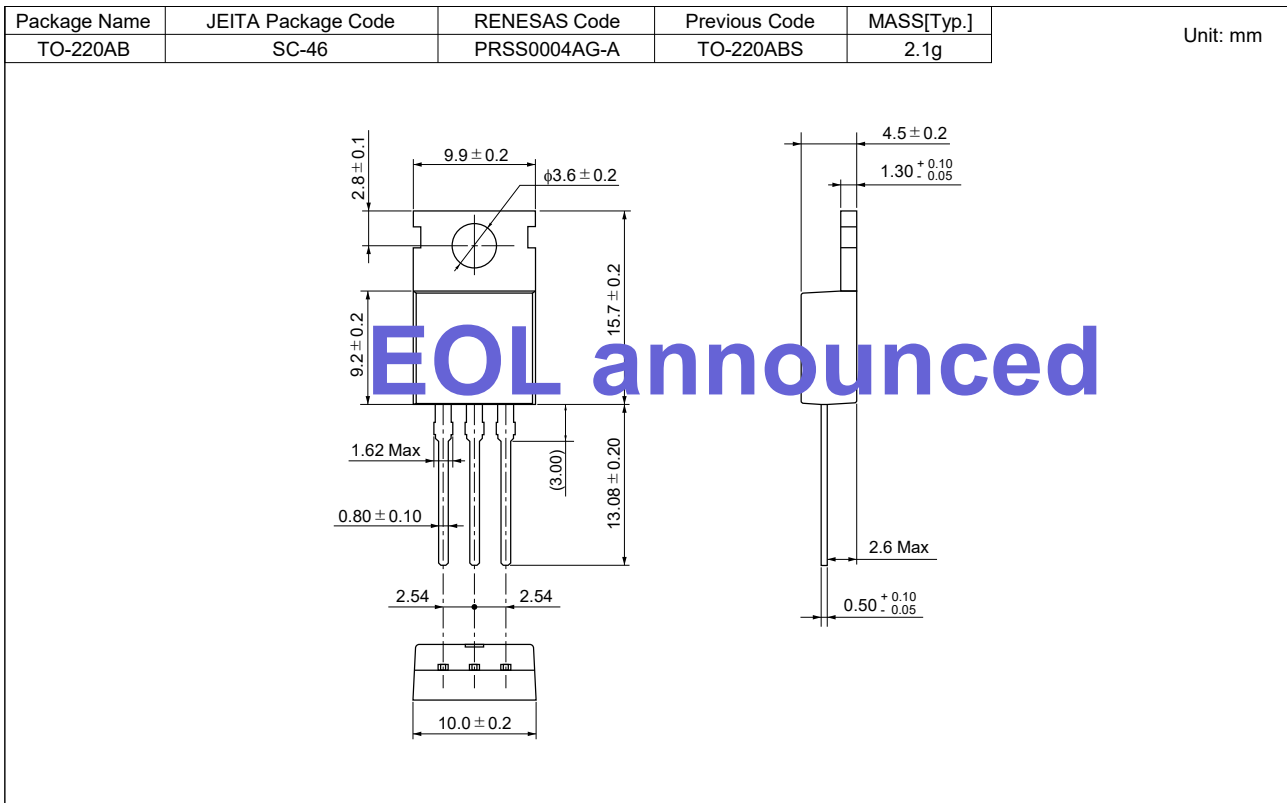

Ordering Information

Orderable Part Number	Package	Quantity ^{Note6}	Remark	Status
BCR12CM-16LB#BH0	TO-220ABA	50 pcs./ tube	Straight type	Mass Production
BCR12CM-16LB#BB0	TO-220ABS	50 pcs./ tube	Straight type	EOL announced

Notes: 6. Please confirm the specification about the shipping in detail.

Notice

1. Descriptions of circuits, software and other related information in this document are provided only to illustrate the operation of semiconductor products and application examples. You are fully responsible for the incorporation or any other use of the circuits, software, and information in the design of your product or system. Renesas Electronics disclaims any and all liability for any losses and damages incurred by you or third parties arising from the use of these circuits, software, or information.
2. Renesas Electronics hereby expressly disclaims any warranties against and liability for infringement or any other claims involving patents, copyrights, or other intellectual property rights of third parties, by or arising from the use of Renesas Electronics products or technical information described in this document, including but not limited to, the product data, drawings, charts, programs, algorithms, and application examples.
3. No license, express, implied or otherwise, is granted hereby under any patents, copyrights or other intellectual property rights of Renesas Electronics or others.
4. You shall not alter, modify, copy, or reverse engineer any Renesas Electronics product, whether in whole or in part. Renesas Electronics disclaims any and all liability for any losses or damages incurred by you or third parties arising from such alteration, modification, copying or reverse engineering.
5. Renesas Electronics products are classified according to the following two quality grades: "Standard" and "High Quality". The intended applications for each Renesas Electronics product depends on the product's quality grade, as indicated below.
"Standard": Computers; office equipment; communications equipment; test and measurement equipment; audio and visual equipment; home electronic appliances; machine tools; personal electronic equipment; industrial robots; etc.
"High Quality": Transportation equipment (automobiles, trains, ships, etc.); traffic control (traffic lights); large-scale communication equipment; key financial terminal systems; safety control equipment; etc.
Unless expressly designated as a high reliability product or a product for harsh environments in a Renesas Electronics data sheet or other Renesas Electronics document, Renesas Electronics products are not intended or authorized for use in products or systems that may pose a direct threat to human life or bodily injury (artificial life support devices or systems; surgical implantations; etc.), or may cause serious property damage (space system; undersea repeaters; nuclear power control systems; aircraft control systems; key plant systems; military equipment; etc.). Renesas Electronics disclaims any and all liability for any damages or losses incurred by you or any third parties arising from the use of any Renesas Electronics product that is inconsistent with any Renesas Electronics data sheet, user's manual or other Renesas Electronics document.
6. When using Renesas Electronics products, refer to the latest product information (data sheets, user's manuals, application notes, "General Notes for Handling and Using Semiconductor Devices" in the reliability handbook, etc.), and ensure that usage conditions are within the ranges specified by Renesas Electronics with respect to maximum ratings, operating power supply voltage range, heat dissipation characteristics, installation, etc. Renesas Electronics disclaims any and all liability for any malfunctions, failure or accident arising out of the use of Renesas Electronics products outside of such specified ranges.
7. Although Renesas Electronics endeavors to improve the quality and reliability of Renesas Electronics products, semiconductor products have specific characteristics, such as the occurrence of failure at a certain rate and malfunctions under certain use conditions. Unless designated as a high reliability product or a product for harsh environments in a Renesas Electronics data sheet or other Renesas Electronics document, Renesas Electronics products are not subject to radiation resistance design. You are responsible for implementing safety measures to guard against the possibility of bodily injury, injury or damage caused by fire, and/or danger to the public in the event of a failure or malfunction of Renesas Electronics products, such as safety design for hardware and software, including but not limited to redundancy, fire control and malfunction prevention, appropriate treatment for aging degradation or any other appropriate measures. Because the evaluation of microcomputer software alone is very difficult and impractical, you are responsible for evaluating the safety of the final products or systems manufactured by you.
8. Please contact a Renesas Electronics sales office for details as to environmental matters such as the environmental compatibility of each Renesas Electronics product. You are responsible for carefully and sufficiently investigating applicable laws and regulations that regulate the inclusion or use of controlled substances, including without limitation, the EU RoHS Directive, and using Renesas Electronics products in compliance with all these applicable laws and regulations. Renesas Electronics disclaims any and all liability for damages or losses occurring as a result of your noncompliance with applicable laws and regulations.
9. Renesas Electronics products and technologies shall not be used for or incorporated into any products or systems whose manufacture, use, or sale is prohibited under any applicable domestic or foreign laws or regulations. You shall comply with any applicable export control laws and regulations promulgated and administered by the governments of any countries asserting jurisdiction over the parties or transactions.
10. It is the responsibility of the buyer or distributor of Renesas Electronics products, or any other party who distributes, disposes of, or otherwise sells or transfers the product to a third party, to notify such third party in advance of the contents and conditions set forth in this document.
11. This document shall not be reprinted, reproduced or duplicated in any form, in whole or in part, without prior written consent of Renesas Electronics.
12. Please contact a Renesas Electronics sales office if you have any questions regarding the information contained in this document or Renesas Electronics products.
(Note 1) "Renesas Electronics" as used in this document means Renesas Electronics Corporation and also includes its directly or indirectly controlled subsidiaries.
(Note 2) "Renesas Electronics product(s)" means any product developed or manufactured by or for Renesas Electronics.

(Rev.4.0-1 November 2017)



SALES OFFICES

Renesas Electronics Corporation

<http://www.renesas.com>

Refer to "<http://www.renesas.com/>" for the latest and detailed information.

Renesas Electronics Corporation
TOYOSU FORESIA, 3-2-24 Toyosu, Koto-ku, Tokyo 135-0061, Japan

Renesas Electronics America Inc.
1001 Murphy Ranch Road, Milpitas, CA 95035, U.S.A.
Tel: +1-408-432-8888, Fax: +1-408-434-5351

Renesas Electronics Canada Limited
9251 Yonge Street, Suite 8309 Richmond Hill, Ontario Canada L4C 9T3
Tel: +1-905-237-2004

Renesas Electronics Europe Limited
Dukes Meadow, Millboard Road, Bourne End, Buckinghamshire, SL8 5FH, U.K
Tel: +44-1628-651-700

Renesas Electronics Europe GmbH
Arcadiastrasse 10, 40472 Düsseldorf, Germany
Tel: +49-211-6503-0, Fax: +49-211-6503-1327

Renesas Electronics (China) Co., Ltd.
Room 1709 Quantum Plaza, No.27 ZhichunLu, Haidian District, Beijing, 100191 P. R. China
Tel: +86-10-8235-1155, Fax: +86-10-8235-7679

Renesas Electronics (Shanghai) Co., Ltd.
Unit 301, Tower A, Central Towers, 555 Langao Road, Putuo District, Shanghai, 200333 P. R. China
Tel: +86-21-2226-0888, Fax: +86-21-2226-0999

Renesas Electronics Hong Kong Limited
Unit 1601-1611, 16/F., Tower 2, Grand Century Place, 193 Prince Edward Road West, Mongkok, Kowloon, Hong Kong
Tel: +852-2265-6688, Fax: +852 2886-9022

Renesas Electronics Taiwan Co., Ltd.
13F, No. 363, Fu Shing North Road, Taipei 10543, Taiwan
Tel: +886-2-8175-9600, Fax: +886 2-8175-9670

Renesas Electronics Singapore Pte. Ltd.
80 Bendemeer Road, Unit #06-02 Hyflux Innovation Centre, Singapore 339949
Tel: +65-6213-0200, Fax: +65-6213-0300

Renesas Electronics Malaysia Sdn.Bhd.
Unit 1207, Block B, Menara Amcorp, Amcorp Trade Centre, No. 18, Jln Persiaran Barat, 46050 Petaling Jaya, Selangor Darul Ehsan, Malaysia
Tel: +60-3-7955-9390, Fax: +60-3-7955-9510

Renesas Electronics India Pvt. Ltd.
No.777C, 100 Feet Road, HAL 2nd Stage, Indiranagar, Bangalore 560 038, India
Tel: +91-80-67208700, Fax: +91-80-67208777

Renesas Electronics Korea Co., Ltd.
17F, KAMCO Yangjae Tower, 262, Gangnam-daero, Gangnam-gu, Seoul, 06265 Korea
Tel: +82-2-558-3737, Fax: +82-2-558-5338