

# INDUCTIVE POSITION SENSOR (IPS) DESIGN GUIDELINES

2021-03-08

RENESAS ELECTRONICS CORPORATION

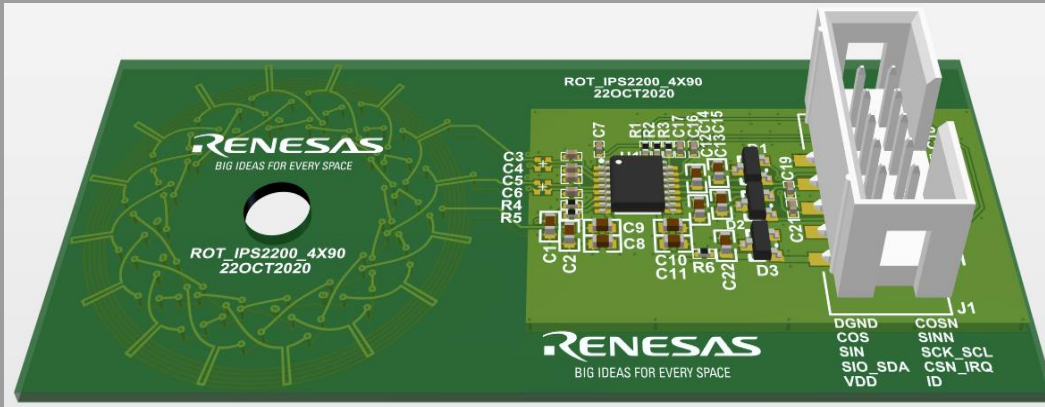

# CONTENTS

---

- Introduction
  - What is an IPS design?
  - Tools for design generation
- Working with custom generated coils (ICOT)
  - How to import and adjust Gerber data?
  - How to export Gerber to PCB?
  - Design hints - Altium Designer
- Working with templates
  - How to obtain the templates?
  - How to connect the sensor coils?
  - Basic EMC recommendations
  - PCB Target design

# WHAT IS AN IPS DESIGN?

PCB = Printed Circuit Board

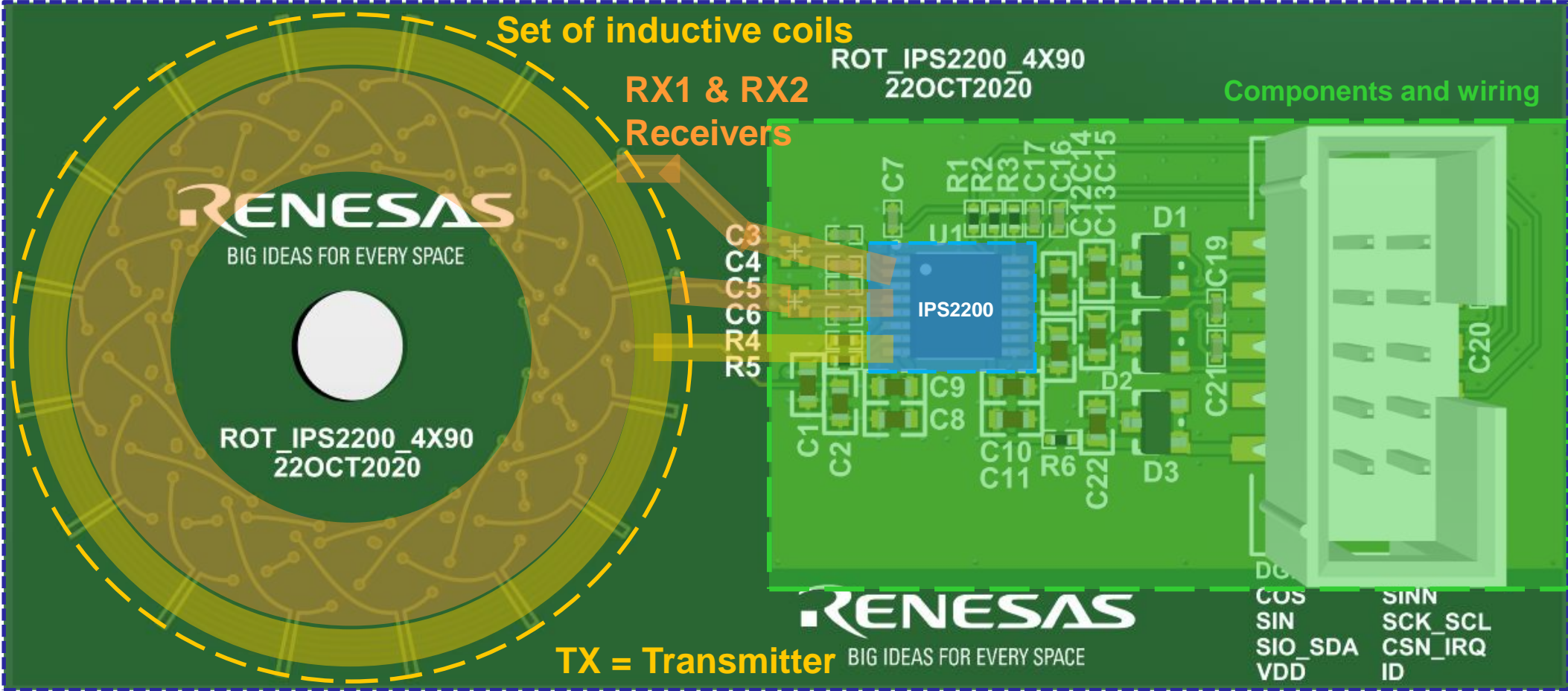

# TOOLS FOR DESIGN GENERATION

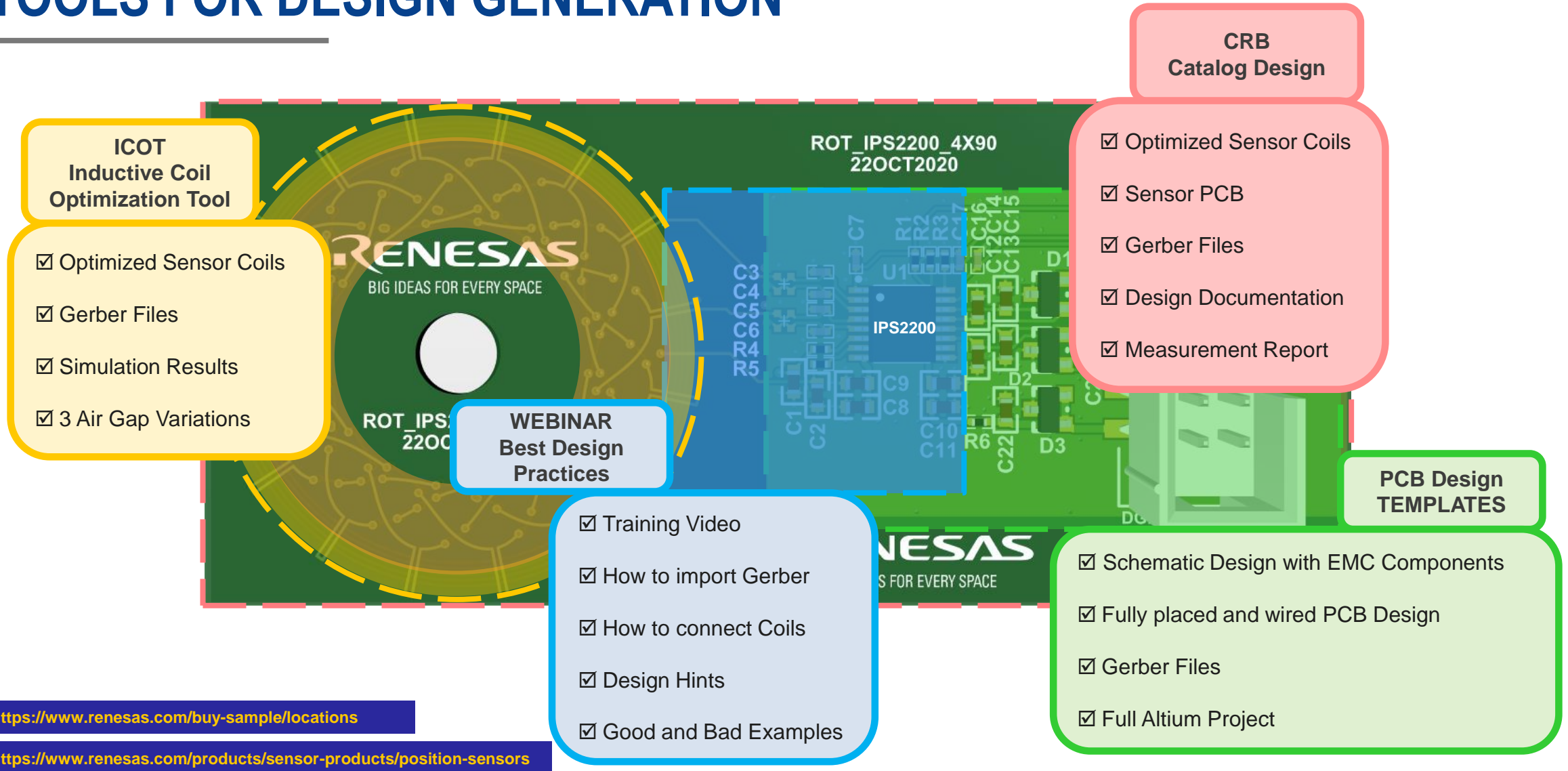

# HOW TO IMPORT GERBER?

☑ Gerber Files of Optimized Sensor Coils

pcb\_layout\_advanced.zip  
227 KB

Save and unpack ZIP container

1

Dear User,  
Your coil design optimization results are attached in the email.  
Please send an email to „[Teamsupport@coildesign](mailto:Teamsupport@coildesign)“ if any questions.

Send the legal disclaimer as a PDF to the customer upfront.  
The Legal Disclaimer can be found on Seismic as “Renesas Inductive Position Sensor”  
**Do not deliver the results and the Gerber files without the customer acknowledgment.**  
**Attach the disclaimer again when the results and the Gerber files are sent.**

Note  
The attached ZIP file is encrypted with your user password.

Regards,  
AASBD Apps support team

NB: This is a generated email please do not reply.

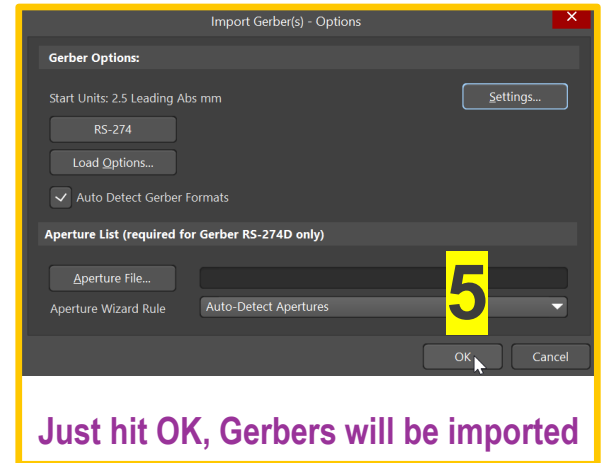
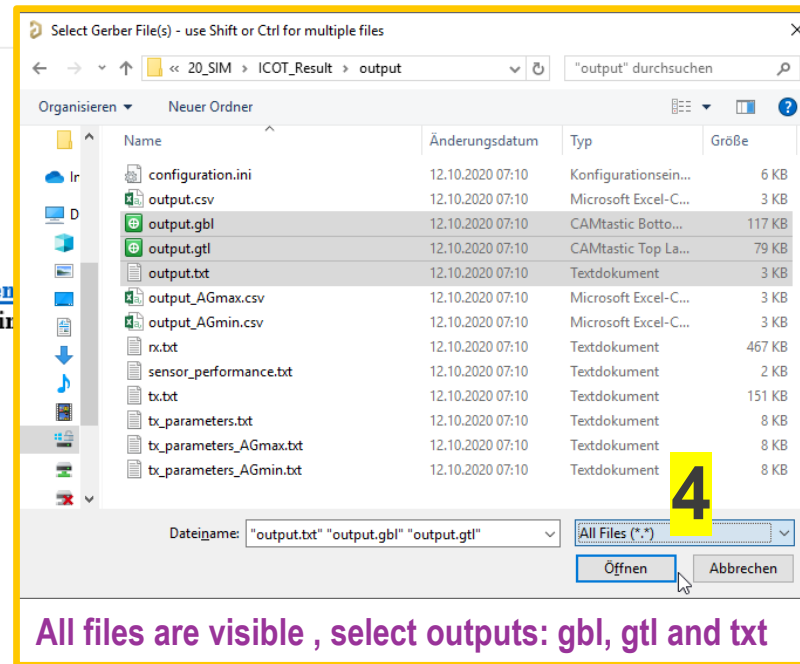
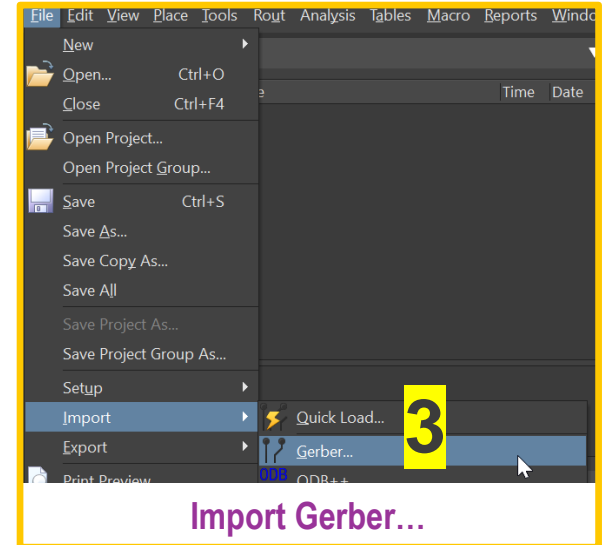
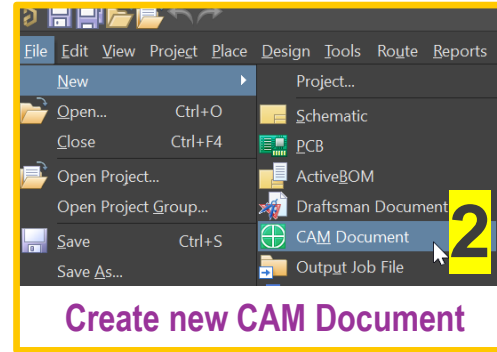

# HOW TO SET THE LAYERS?

```

Home Page CAMtastic.Cam * LogFileLog_2020_10_14_16_3_33.log
CAMtastic DXF : Gerber / NC Drill / Mill/Rout Import Process Report
CAMtastic File : CAMtastic.Cam
Date : 14/10/2020
Time : 4:33:33 PM

Information : Layer 1 - output.gbl - start loading.
Information : Layer 1 - output.gbl - end loading.
Information : Layer 2 - output.gtl - start loading.
Information : Layer 2 - output.gtl - end loading.
Information : Layer 3 - output.txt - start loading.
Information : Layer 3 - output.txt - end loading.

Statistics :
Errors : 0
Warnings : 0
Information : 6
    
```

**1**

0 Errors and 0 Warnings → good

**2**

Back to CAMtastic, coils imported

Click Tables, Layers...

**3**

#	Layer Name	Type	Draw	Flash	On	Lock	Delete
1	output.gbl	Bottom	<input checked="" type="checkbox"/>	<input checked="" type="checkbox"/>	<input checked="" type="checkbox"/>	<input type="checkbox"/>	<input type="checkbox"/>
2	output.gtl	Top	<input checked="" type="checkbox"/>	<input checked="" type="checkbox"/>	<input checked="" type="checkbox"/>	<input type="checkbox"/>	<input type="checkbox"/>
3	output.txt	Border	<input checked="" type="checkbox"/>	<input checked="" type="checkbox"/>	<input checked="" type="checkbox"/>	<input type="checkbox"/>	<input type="checkbox"/>

Set the TXT file for drilling layer

**4**

#	LayerName	Layer Logical Order	Layer Physical O...
2	L2: gtl	2	1
1	L1: gbl	1	2

Set physical Layers: GTL→1, GBL →2

**5**

# HOW TO SET THE VIAS?

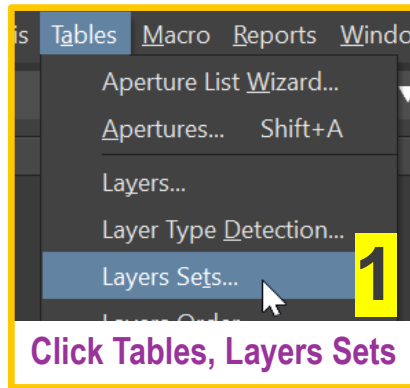

Click Tables, Layers Sets

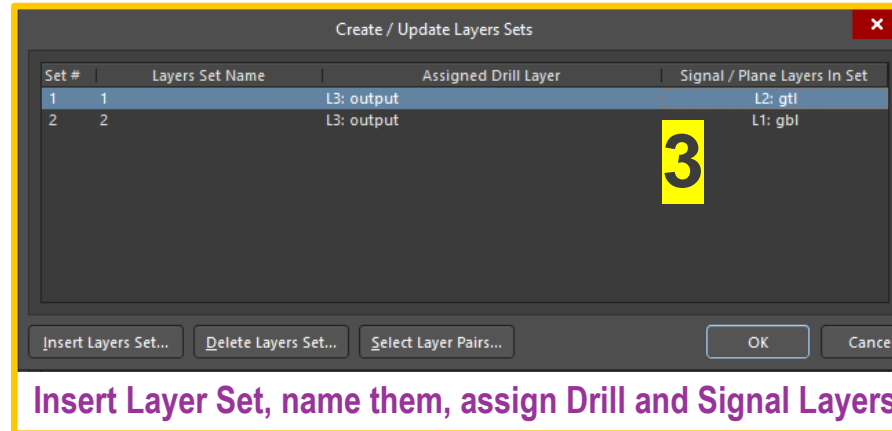

Insert Layer Set, name them, assign Drill and Signal Layers

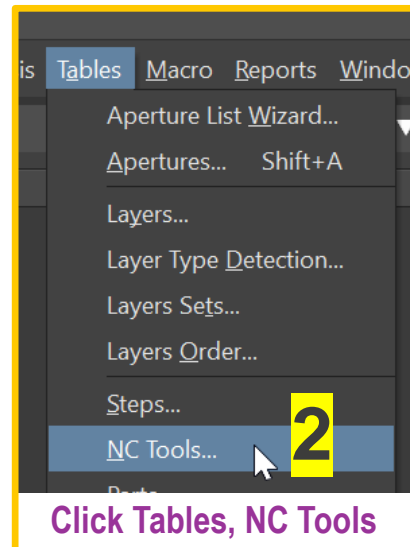

Click Tables, NC Tools

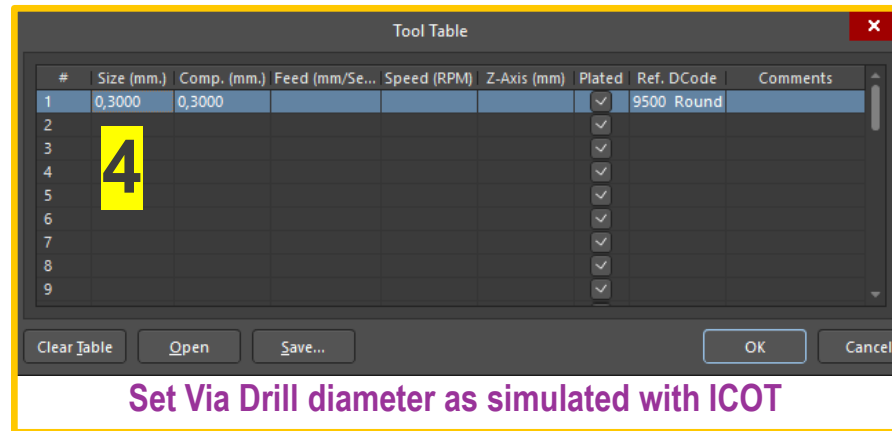

Set Via Drill diameter as simulated with ICOT

# HOW TO EXPORT TO PCB?

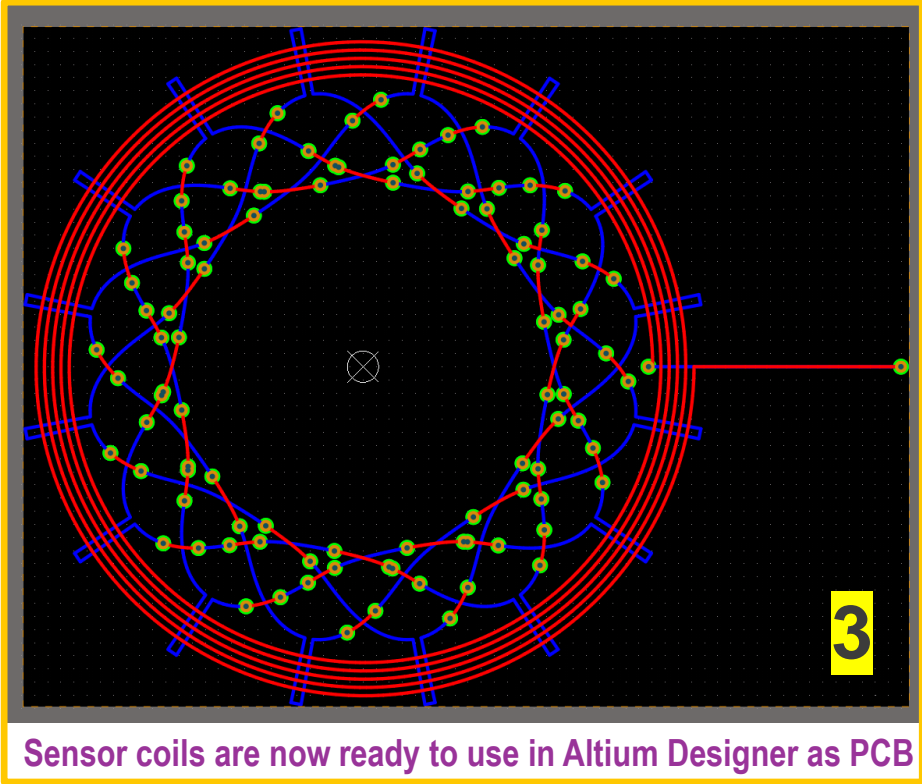
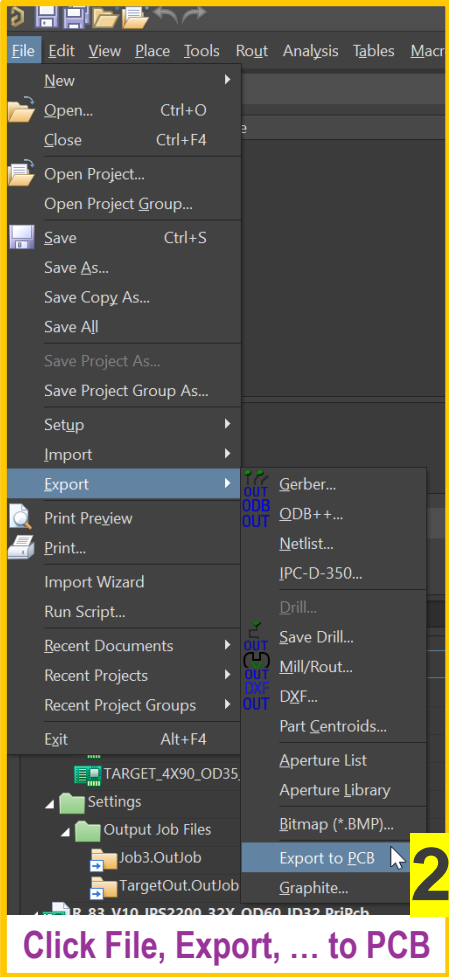
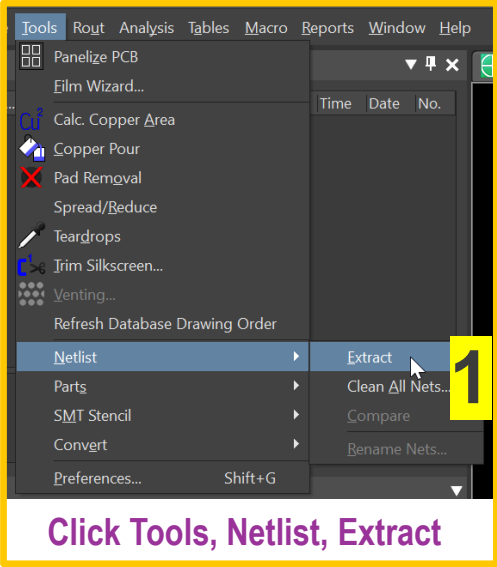





# DESIGN HINT FOR ADJUSTING VIAS

Properties  
Board Components (and 12 more)

Search

Selection Filter

Custom

Components 3D Bodies Keepouts Tracks

Arcs **Pads 1** Regions Polygons

Fills Texts Other

Select only Pads

2

Select all the Pads/Padstacks

Properties  
Pad Components (and 12 more)

Search

Net Information 3

Properties

Pad Stack

Simple Top-Middle-Bottom Full Stack

Shape Round

(X/Y) 0.6mm 0.6mm

Corner Radius 50%

Thermal Relief Relief, 0.254mm, 0.254mm ...

Offset From Hole Center (X/Y) 0mm 0mm

Round Rect Slot

Hole Size 0.3mm

Tolerance + N/A - N/A

Length 0.762mm

Rotation 0.000

Plated

Paste Mask Expansion

Solder Mask Expansion

Rule Manual

Top 0.102mm Tented

Bottom 0.102mm Tented

From Hole Edge

Adjust as needed (tented?)

4

Ready



# DESIGN HINT FOR SHIFTING LAYERS

**1**

Open Stack Manager

**4**

Select Tracks and Arcs

**5**

Select from and to layers

**7**

Select copy to layer

**8**

Set visible layers again

**2**

Insert Internal Layers

#	Name	Material	Type	Weight	Thickness
	Top Overlay		Overlay		
	Top Solder	Solder Resist	Solder Mask		0.01016mm
1	Top Layer		Signal	1oz	0.0356mm
	Dielectric 2	PP-006	Prepreg		0.11mm
2	Layer 1	CF-004	Signal	1oz	0.035mm
	Dielectric 1	FR-4	Dielectric		1.11mm
3	Layer 2	CF-004	Signal	1oz	0.035mm
	Dielectric 3	PP-006	Prepreg		0.11mm
4	Bottom Layer		Signal	1oz	0.0356mm
	Bottom Solder	Solder Resist	Solder Mask		0.01016mm
	Bottom Overlay		Overlay		

**3**

4 Layers are ready, Save and Exit Stack

**6**

From layer is visible,select everything to copy

**9**

Coils have been copied from BOT to Layer2

# HOW TO OPEN THE TEMPLATE?

Download Templates – Altium Project Files

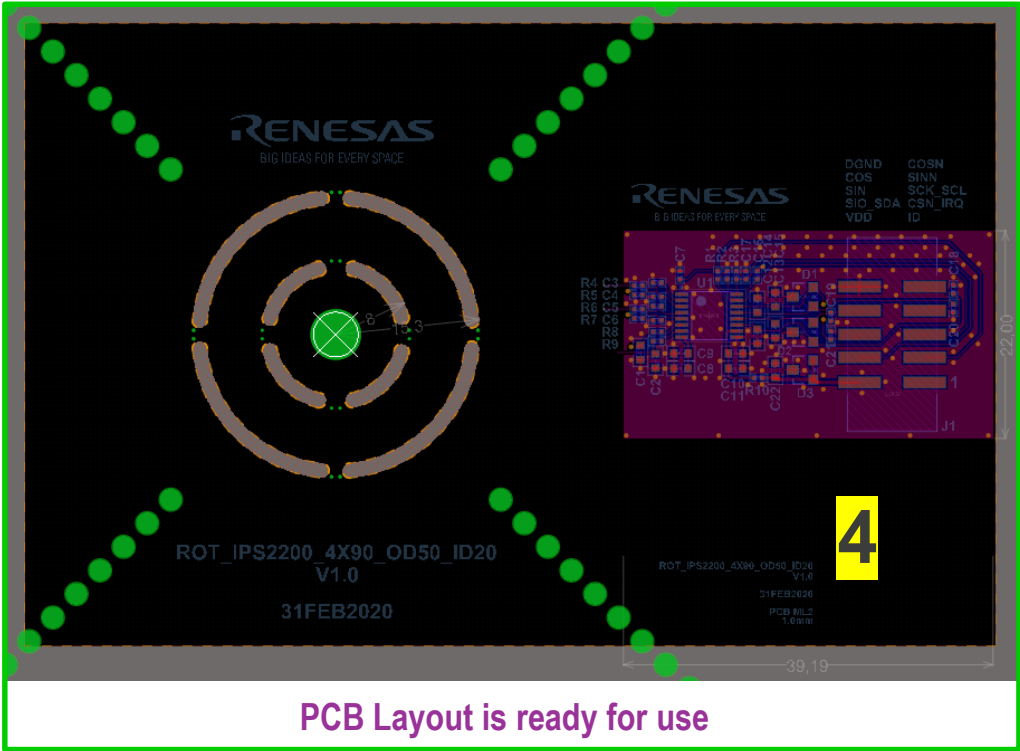
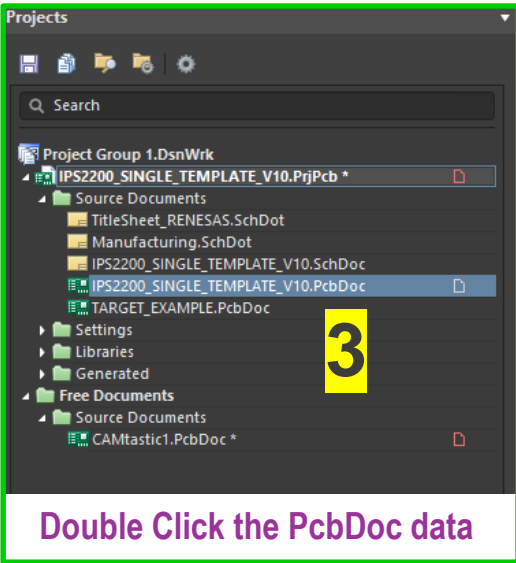
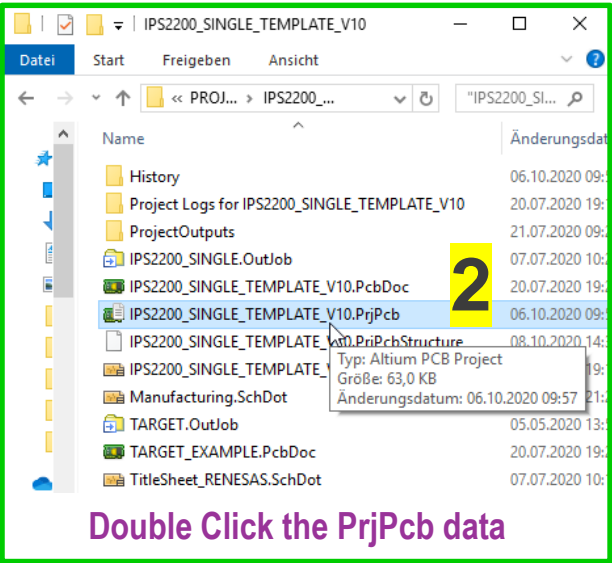

# HOW TO ADJUST THE TEMPLATE?

- Remove unused Mounting Holes **1**
- Or add/adjust as needed **1**

- Remove/adjust Text, Logo, etc. **2**

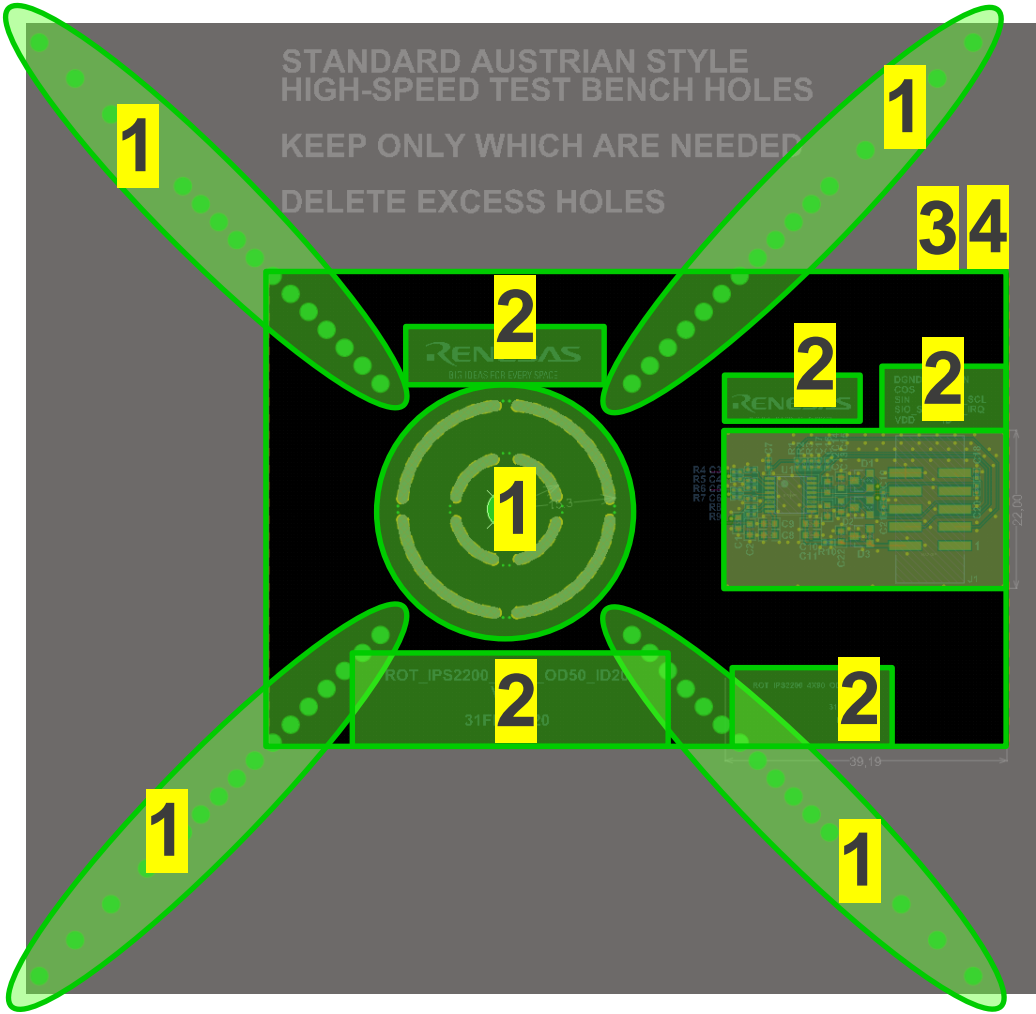

- Adjust Board Shape freely **3**

- Adjust Layer Stack **4**

# HOW TO COPY/PASTE THE COILS?



Back to the imported coils



Filters all ON

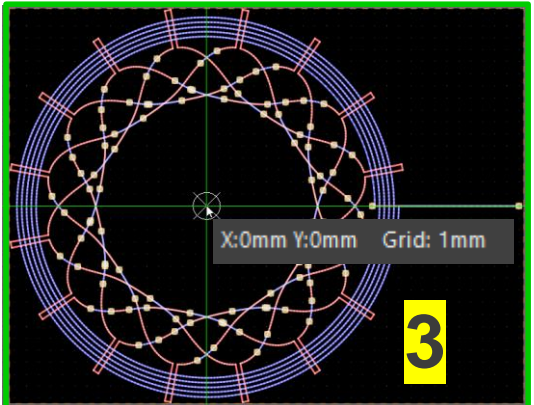

Select everything, press ctrl+c and click on the origin (0;0)

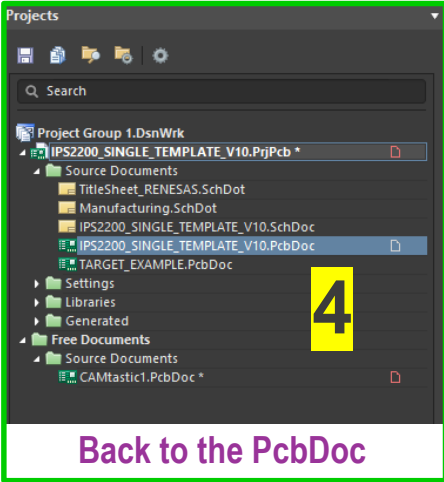

Back to the PcbDoc

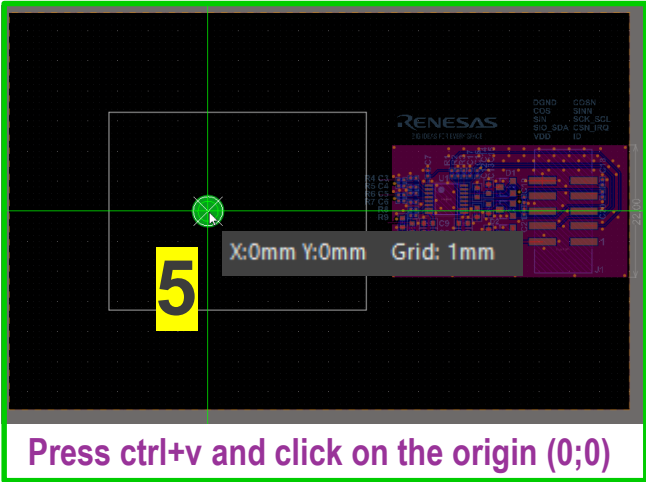

Press ctrl+v and click on the origin (0;0)

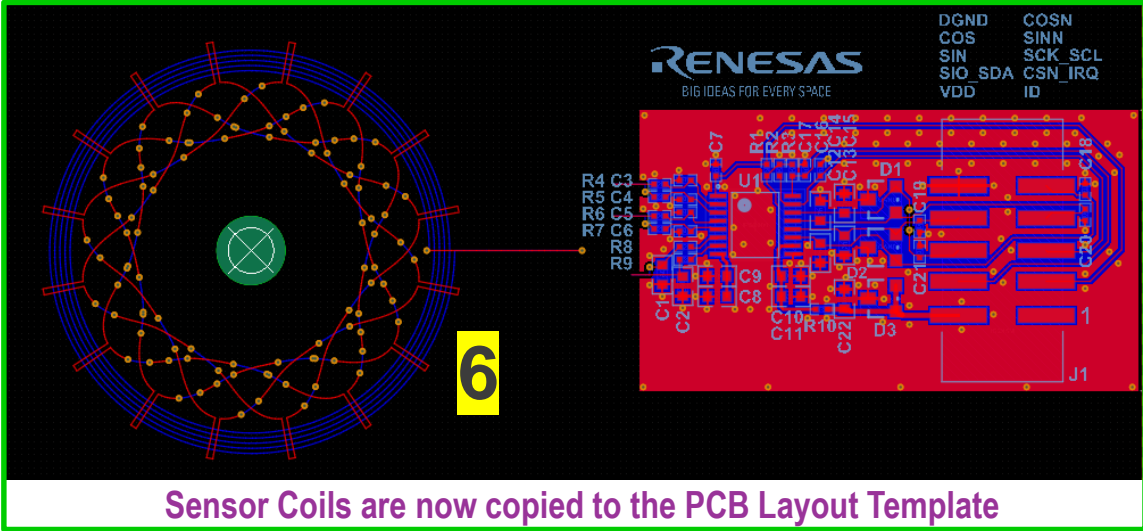

Sensor Coils are now copied to the PCB Layout Template



# DESIGN HINT FOR COMPACTING THE BOARD

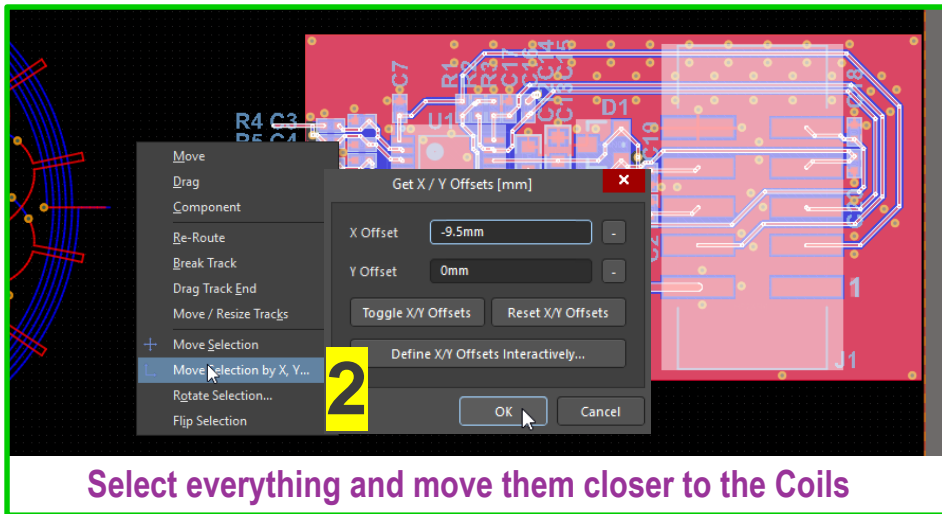
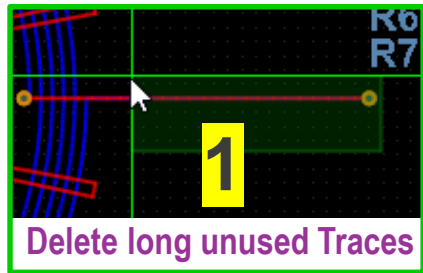

To eliminate the unwanted influence of large metallic objects:

- Keep **3mm** minimum distance from copper planes to the coils!
- Keep **5mm** or larger safety distance if your design lets you!

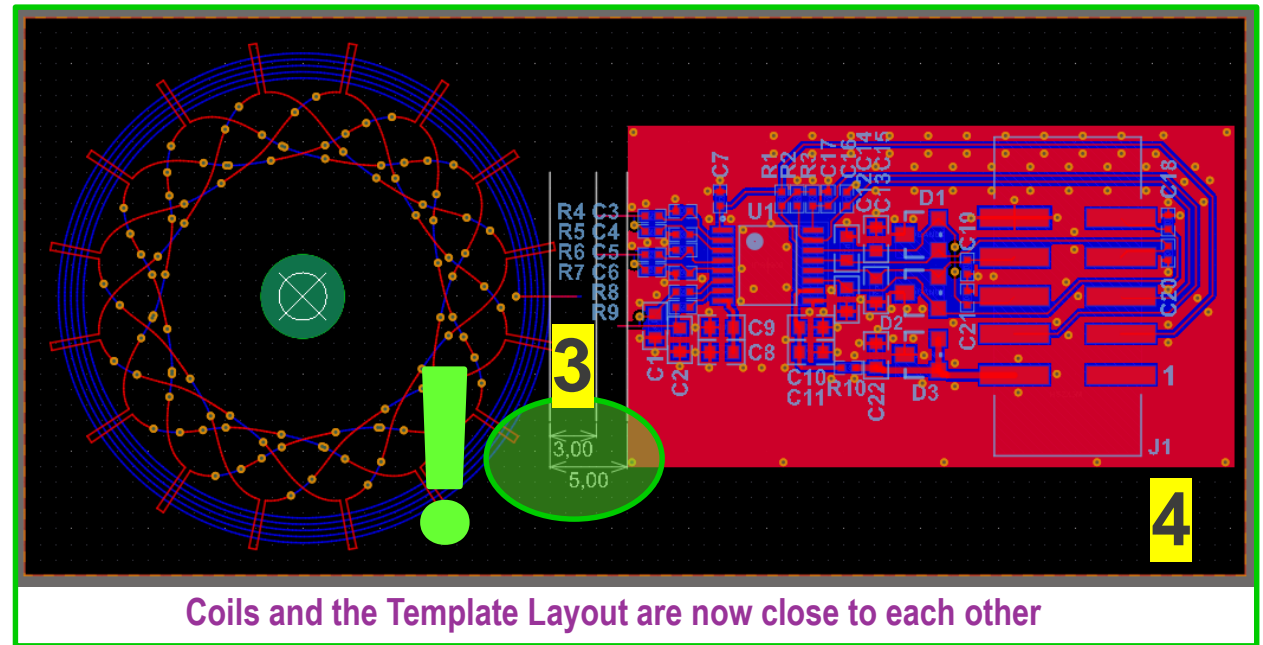

# HOW TO RENAME THE COILS?

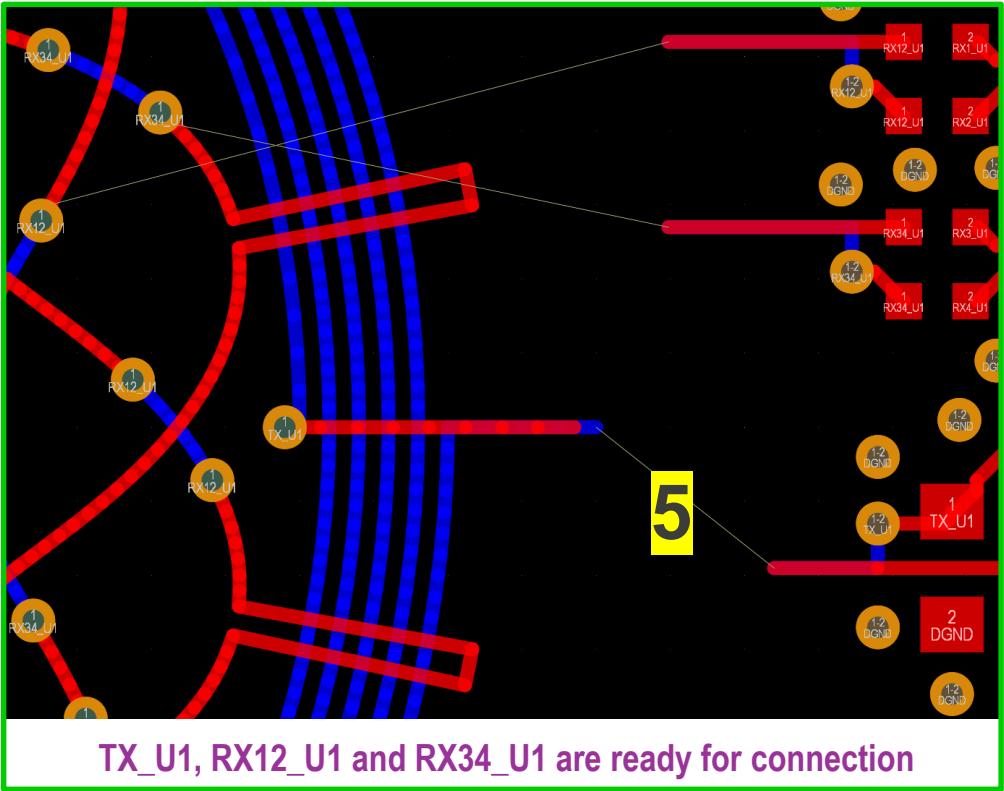
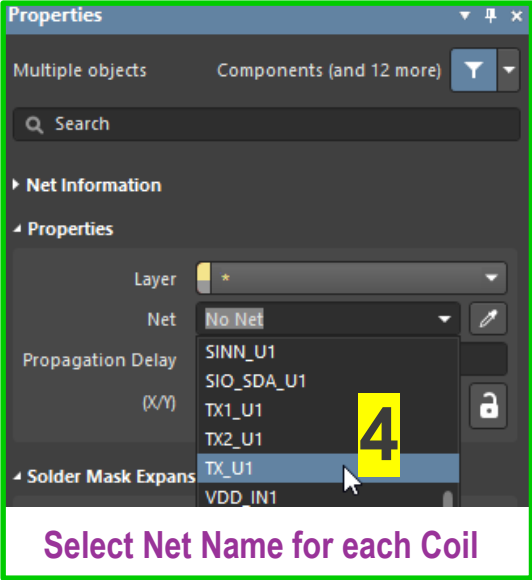
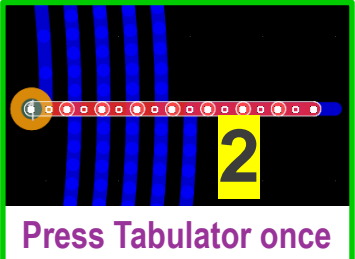
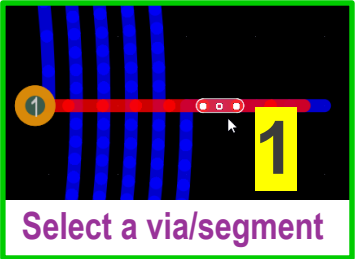

# HOW TO CONNECT THE COILS?

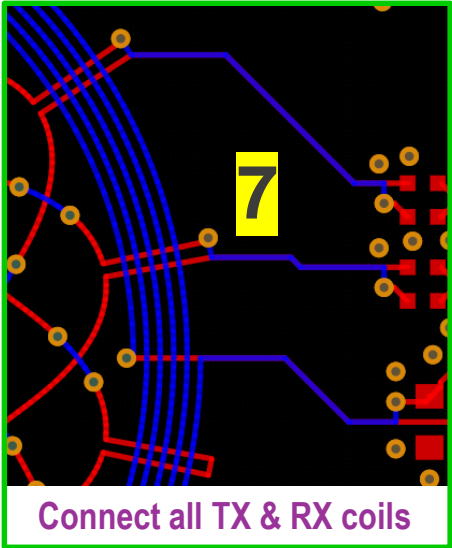
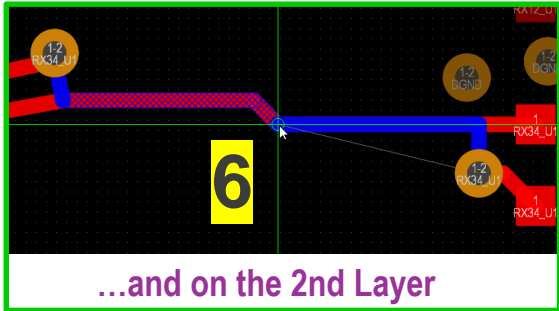
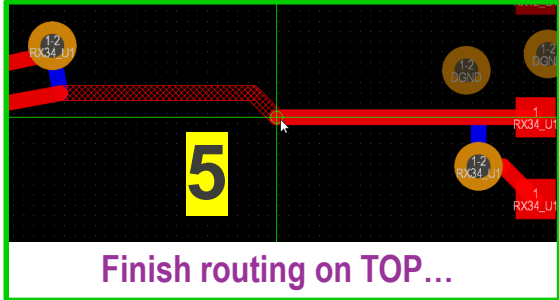
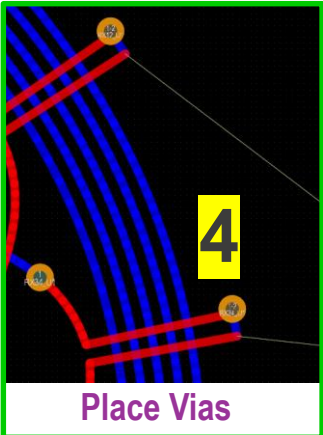
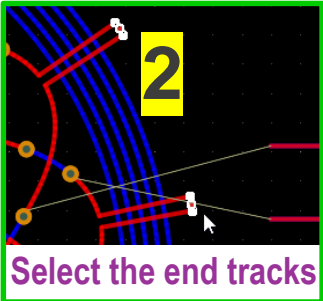
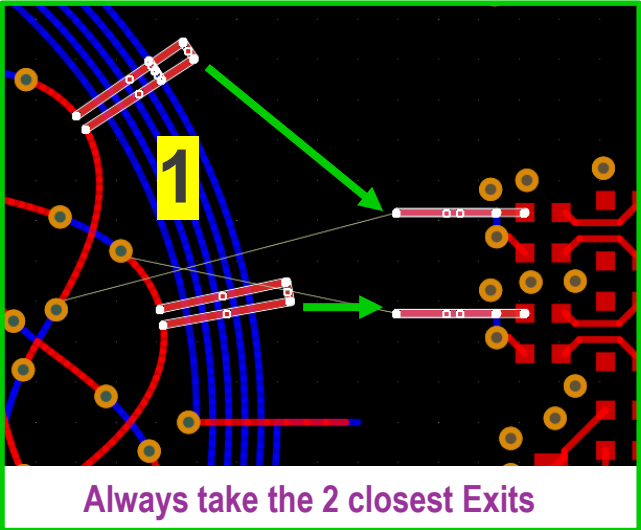





# DESIGN HINT FOR COIL ROUTING

To eliminate the unwanted influence of bad wiring:

- 1**  Always use the Exits as simulated
- 2**  Always route the Coils overlapped on neighboring Layers!  
 Don't change the Renesas Layout Template

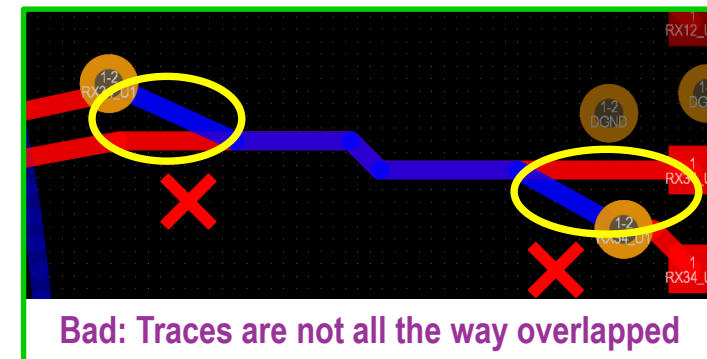
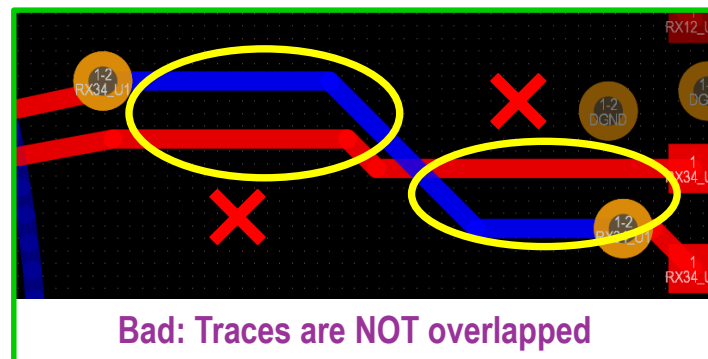
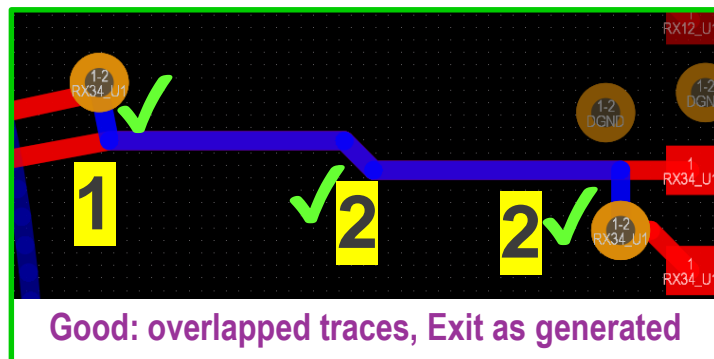



# DESIGN HINT FOR GND PLANES

- 1**  Always fill all the Copper Layers with GND Planes
- 2**  Have at least one fully filled GND Layer below IPS2200
- 3**  Use GND Vias to connect the Layers on every 1-2mm
- 4**  Consider return Current Paths especially for VDD Supply
- 5**  Only very short Tracks are allowed on GND Layer

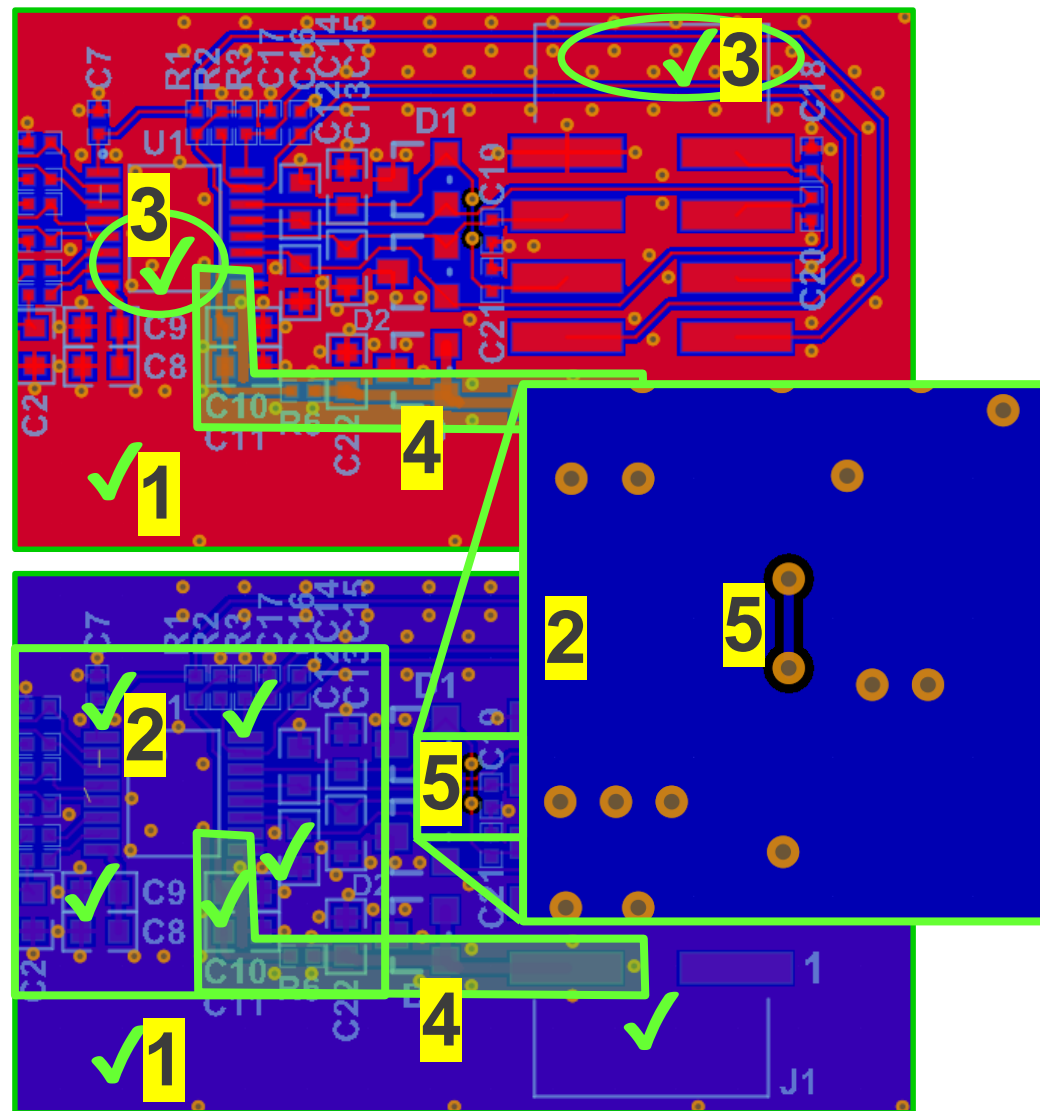

# HOW TO DESIGN A PCB TARGET?

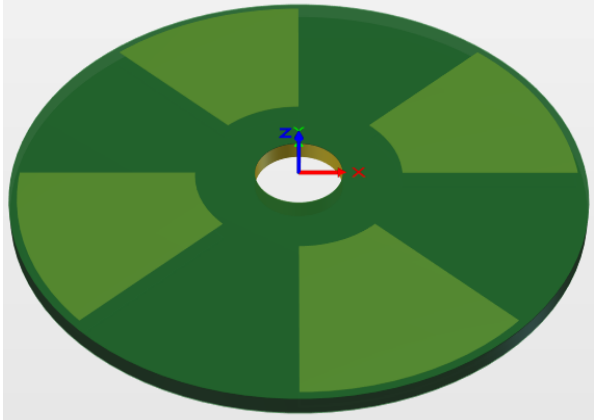

**1**

Open Target PcbDoc

**2**

Delete unwanted drawings

**3**

Design d1mm larger PCB Outline

**4**

Draw one wing as large as simulated

**5**

Generate solid Copper Plane

**6**

Copy/Paste Circular Array

# IPS2200 SCHEMATIC TEMPLATES

**1** Remove Components if unused or change them freely to your needs!

**2** We advise NOT to change the rest of the schematic!

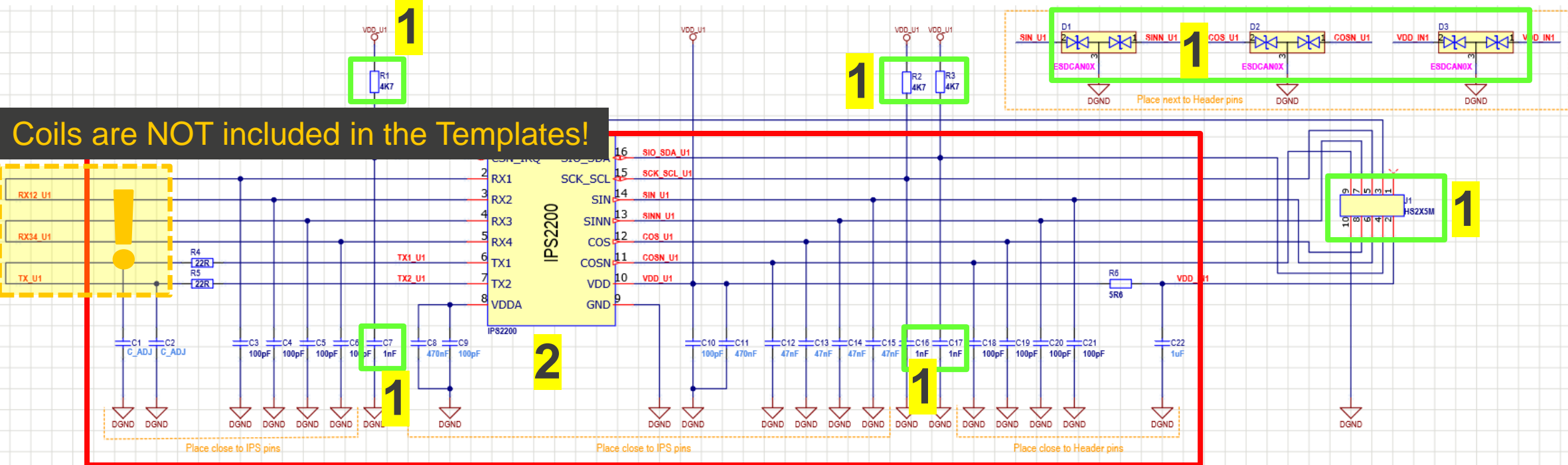

**THANK YOU FOR YOUR ATTENTION!**