





Technical Data of Ceramic Resonator

Type CSA4.19MG
CST4.19MGW

Applied to μ PD780032A

TOYAMA MURATA MANUFACTURING CO., LTD.

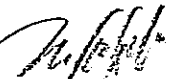
Product Engineering Service Section I
Engineering Service Department
Piezoelectric Components Group

Approved by	Checked by	Checked by	Issued by	Issued Date	TCD No.
 S.Iwasaki	 K.Kuramoto	 M.Kurosaka	 Y.Ishiho	Jan 28, 1999	TCD-99-6A20

Contents

1.	Test Circuit	1
2.	Temperature Characteristics of Oscillating Frequency, Oscillating Voltage	2
3.	Rise Time, Oscillating Frequency, Oscillating Voltage vs VddCharacteristics	3
4.	Oscillating Frequency, Oscillating Voltage vs (C1,C2) Characteristics	4
5.	Oscillating Frequency, Oscillating Voltage, Rise Time, Oscillating Voltage vs C(C1=C2) Characteristics	5

Test Circuit

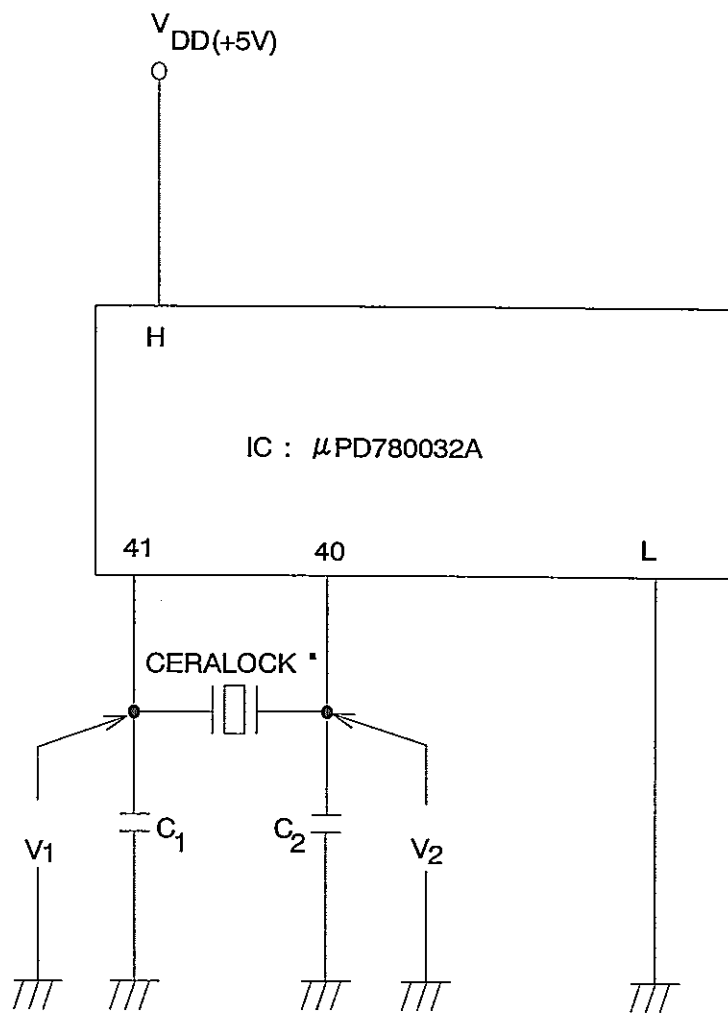

H:10,24,35,36,38

L:9,25 ~34,39,42

Recommendable Value

CERALOCK® : CSA4.19MG

C1 = 30 [pF]

C2 = 30 [pF]

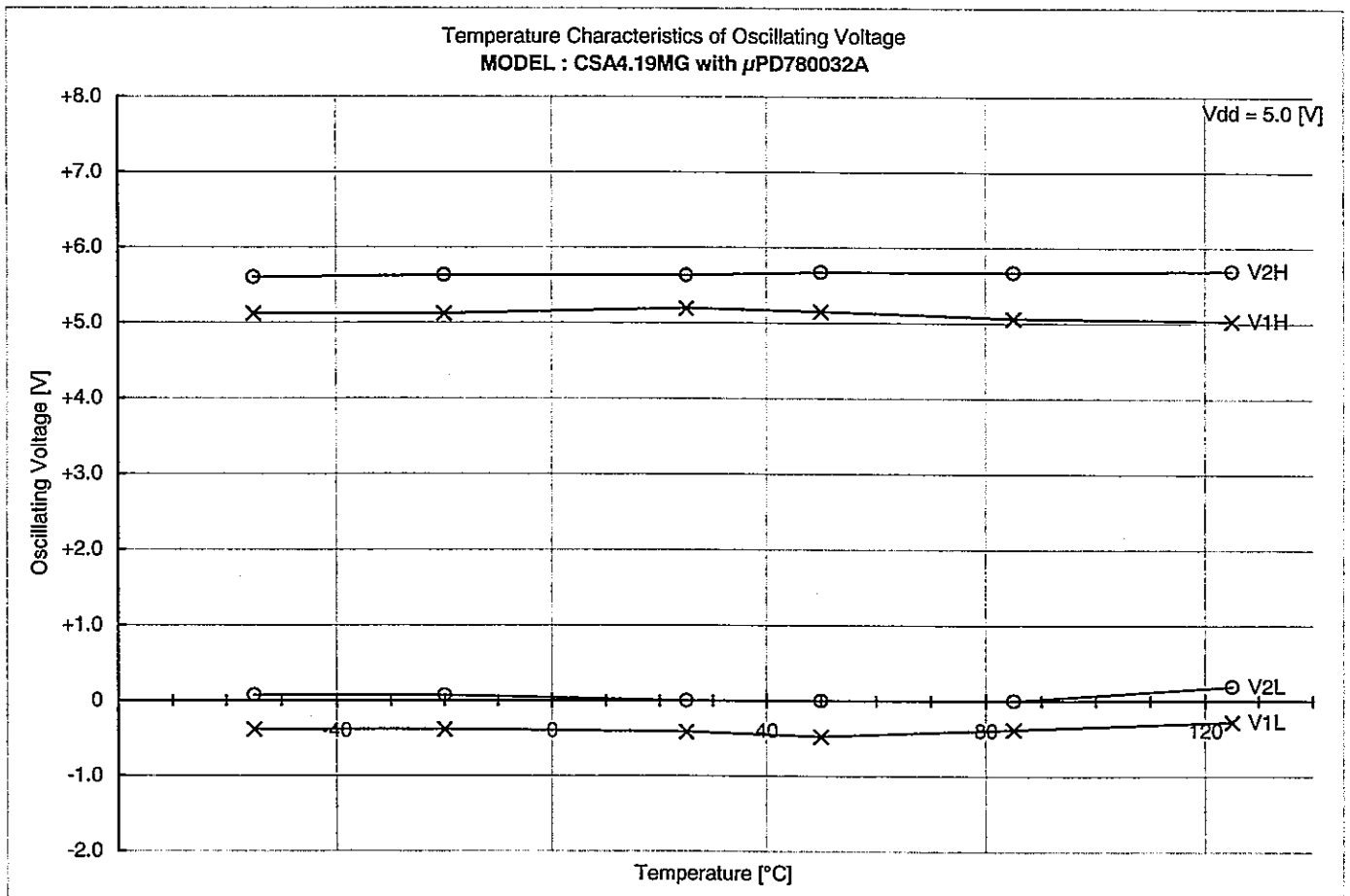
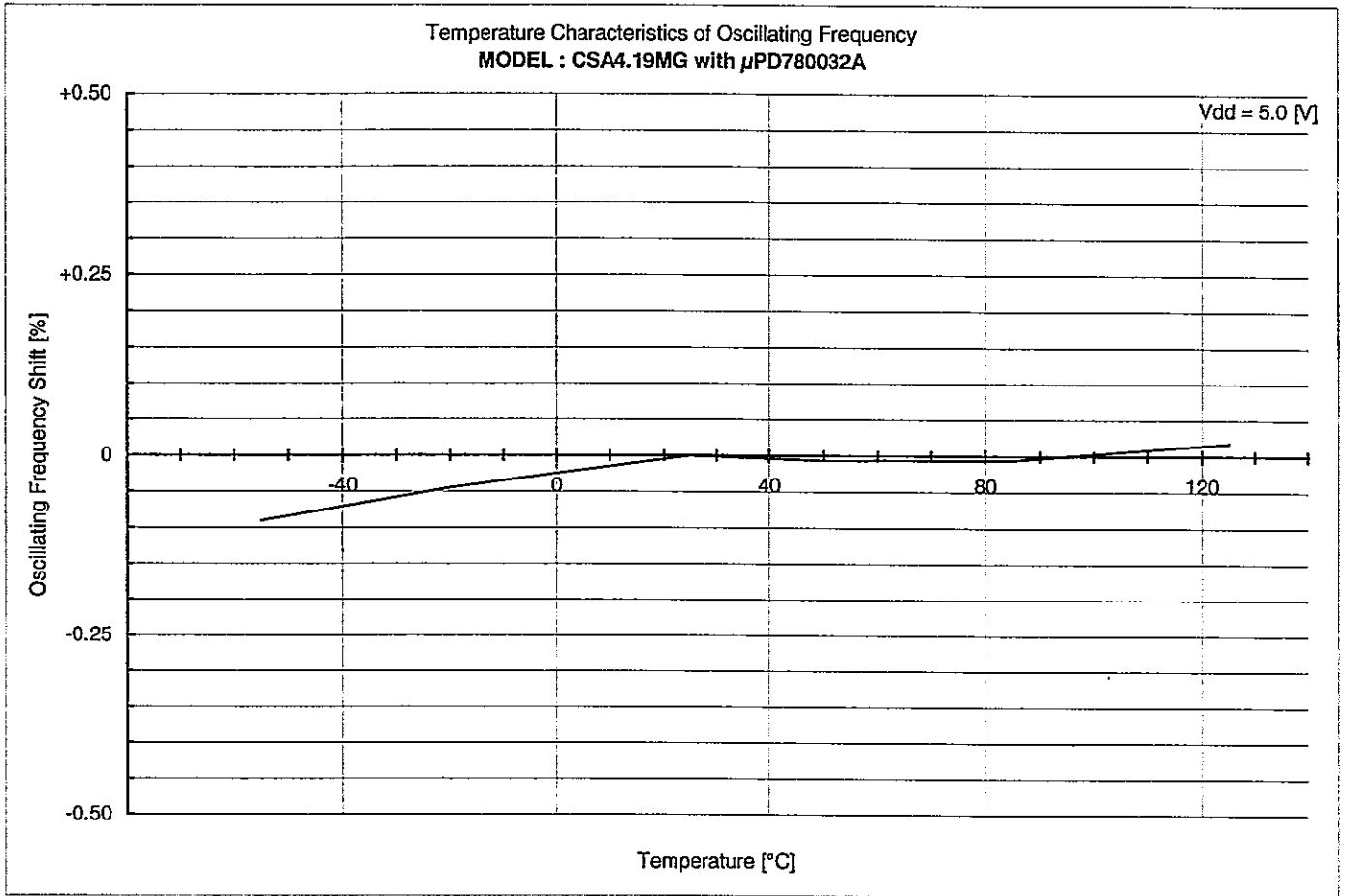

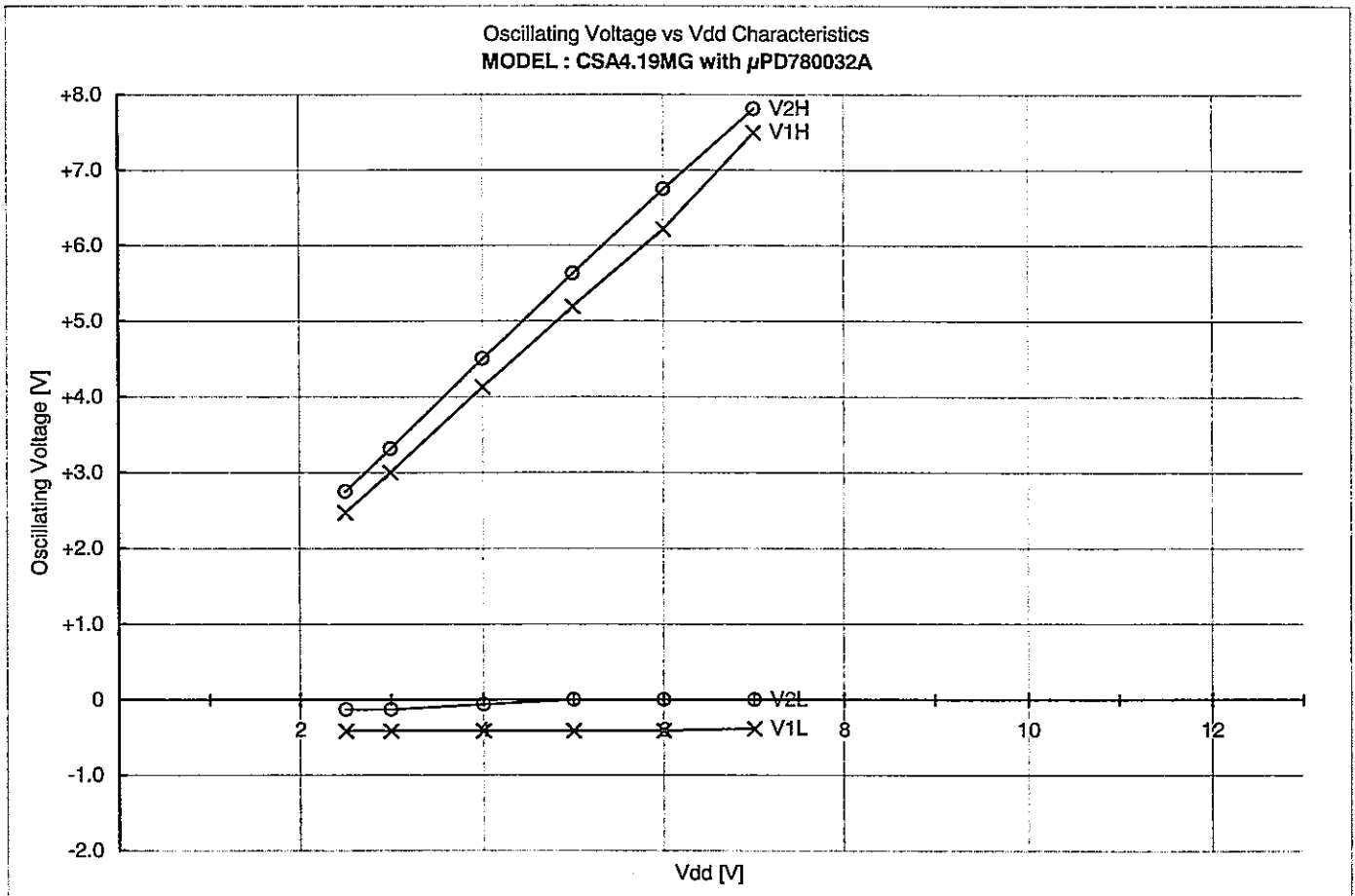
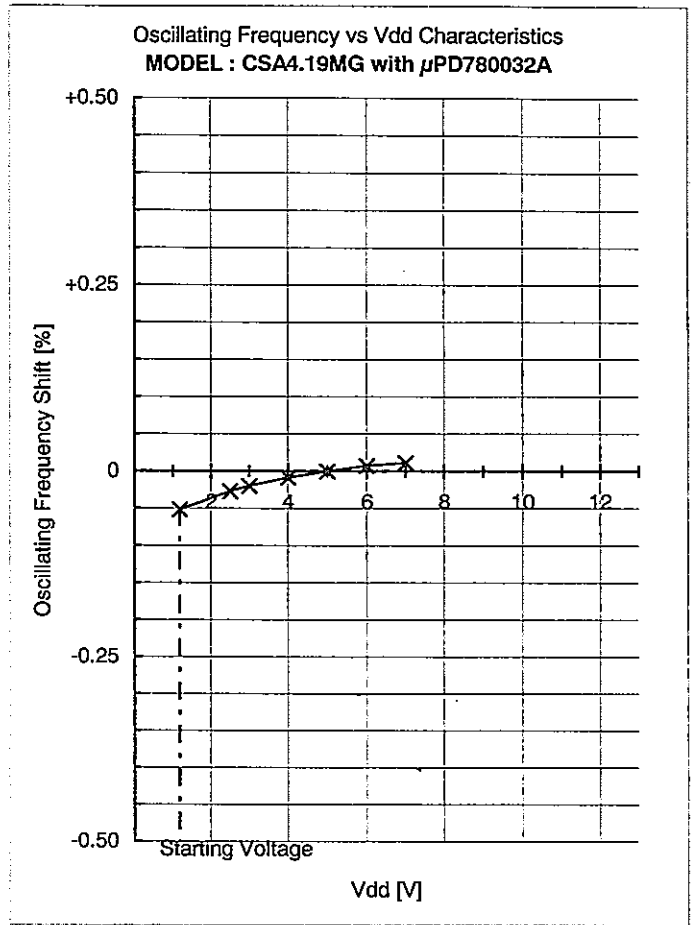
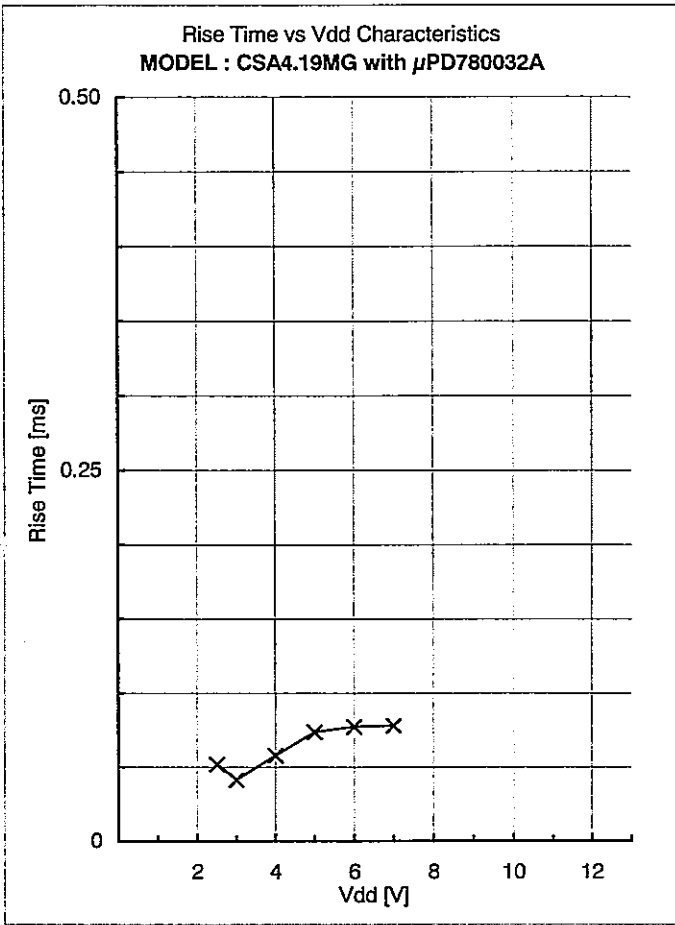

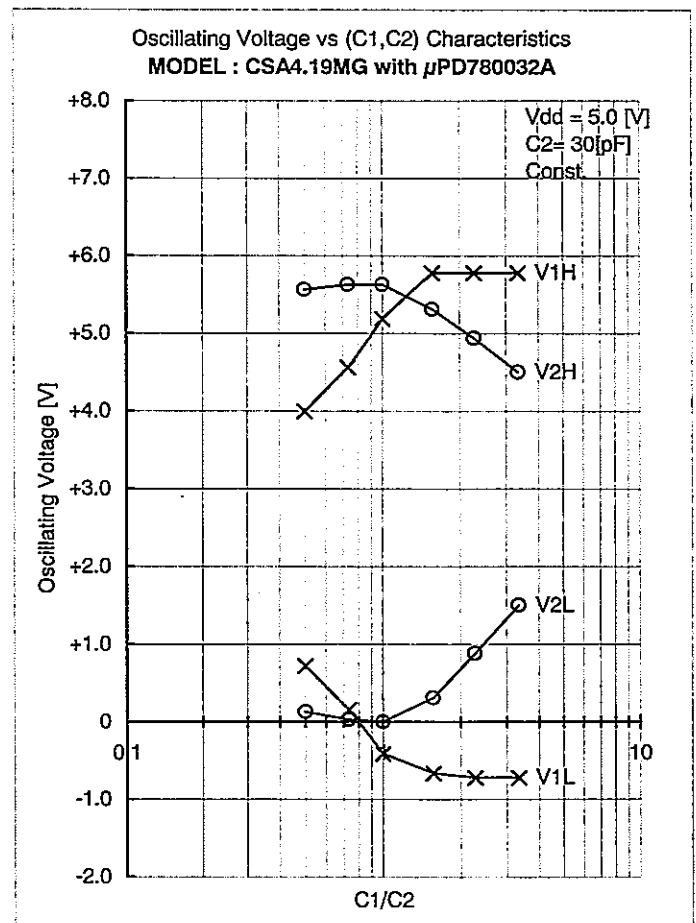
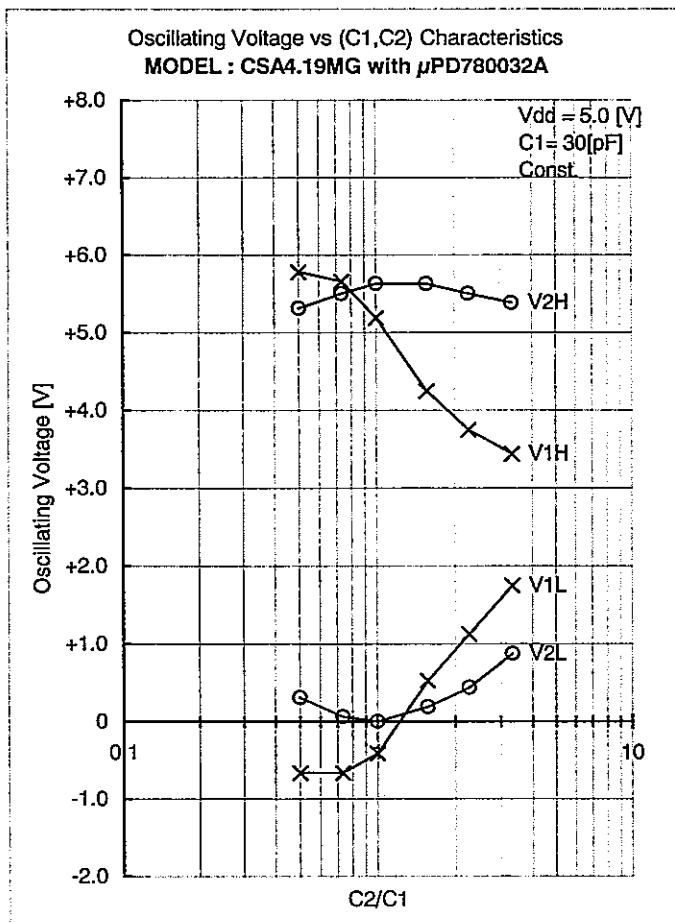
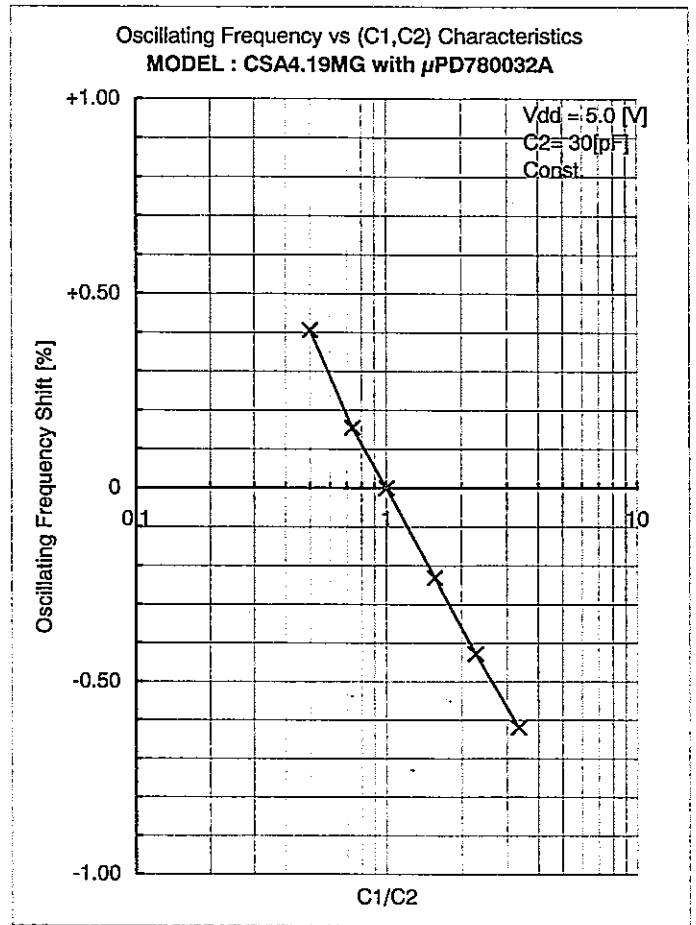
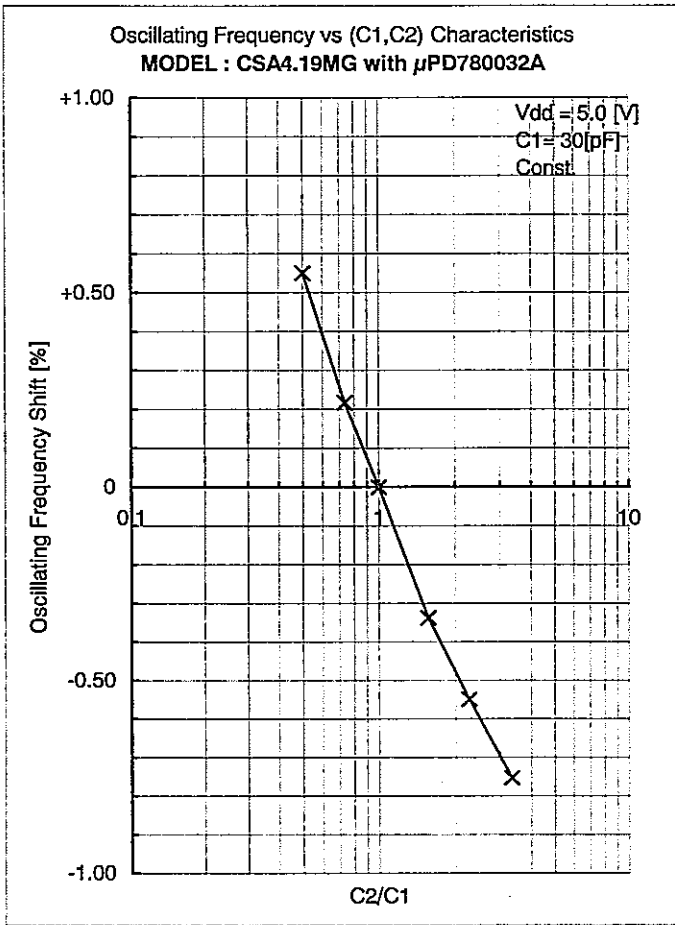

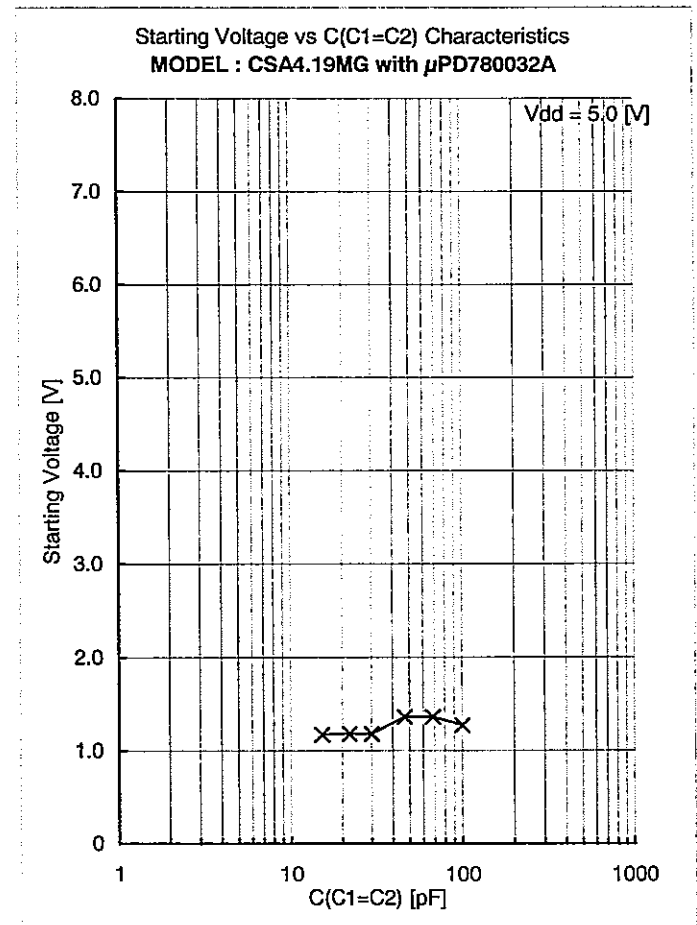
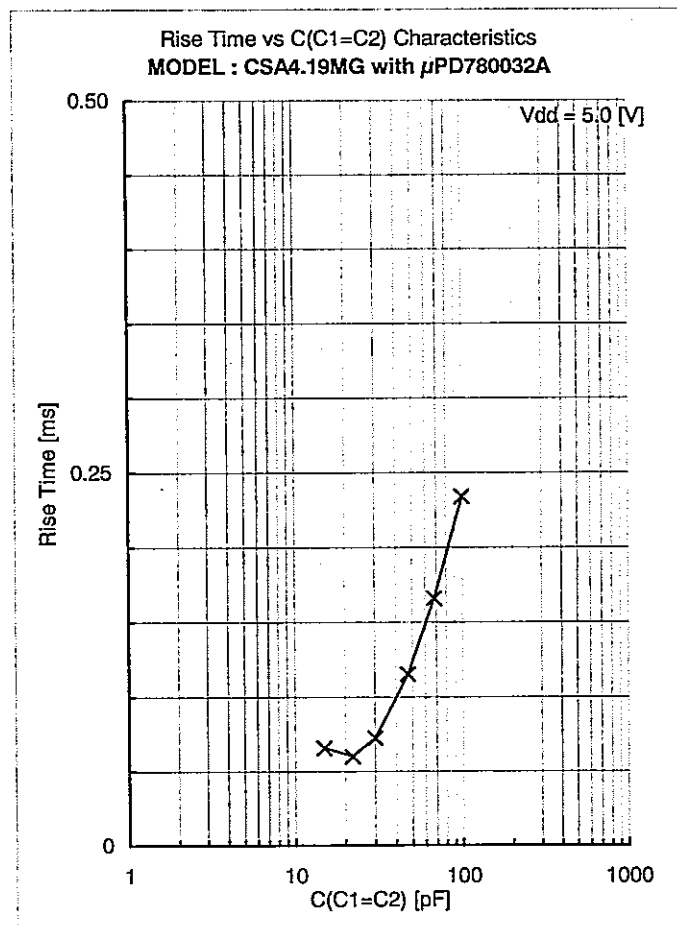
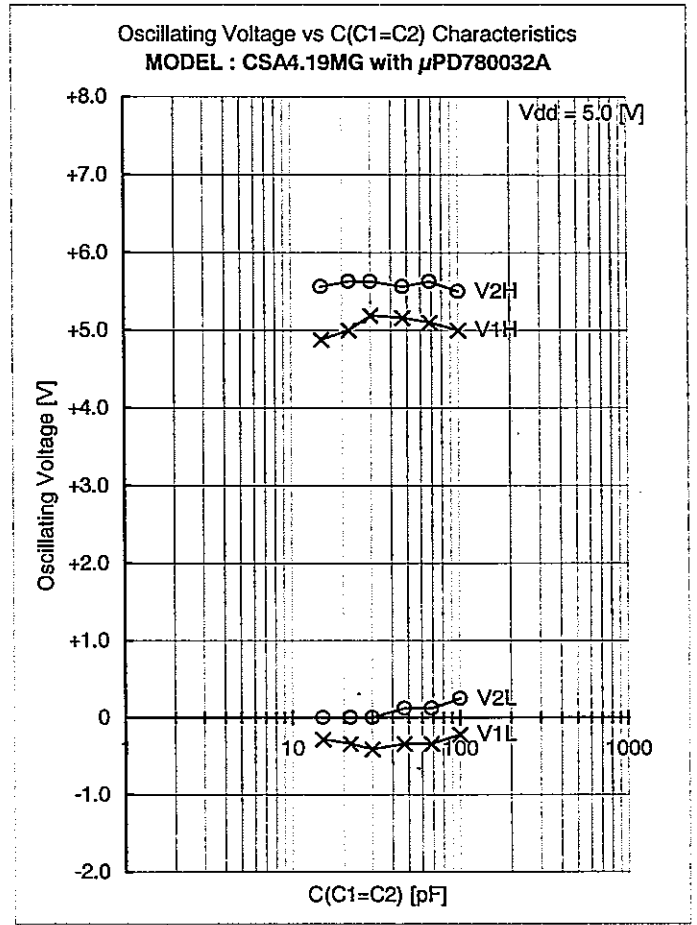
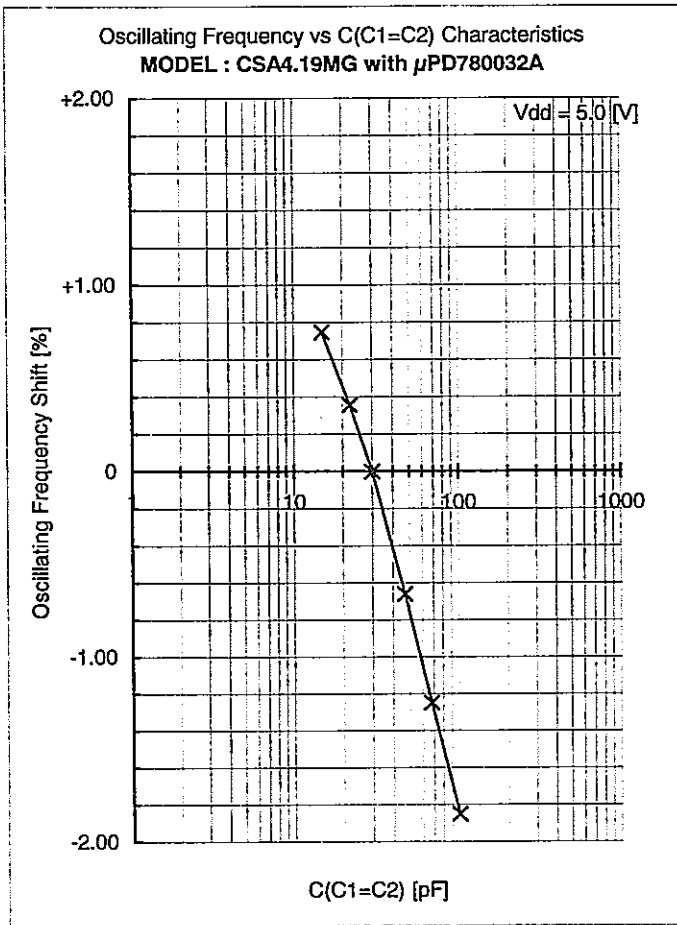

Appendixes

6.	Comparison Table	6
7.	Frequency Correlation Data	7
8.	Rise Time vs Vdd Characteristics (Ta;Variable), Temperature Characteristics of Starting Voltage IC : W03	8
9.	Rise Time vs Vdd Characteristics (Ta;Variable), Temperature Characteristics of Starting Voltage IC : W05	9
10.	Rise Time vs Vdd Characteristics (Ta;Variable), Temperature Characteristics of Starting Voltage IC : W07	10
11.	Rise Time vs Vdd Characteristics (Ta;Variable), Temperature Characteristics of Starting Voltage IC : W09	11
12.	Rise Time vs Vdd Characteristics (Ta;Variable), Temperature Characteristics of Starting Voltage IC : W15	12
13.	Rs vs Vdd Characteritics	13
14.	Rs vs C(C1=C2) Characteritics	14

Comparison Table

IC : No	V1H [V]	V1L [V]	V1p-p [V]	V2H [V]	V2L [V]	V2p-p [V]	Fosc [kHz]	Trise [ms]	Vstart [V]
W03	5.19	-0.41	5.60	5.63	-0.06	5.69	4216.265	0.064	1.29
W05	5.19	-0.34	5.53	5.63	0.00	5.63	4216.365	0.080	1.08
W07	5.19	-0.41	5.60	5.63	-0.13	5.76	4216.319	0.067	1.29
W09	5.22	-0.34	5.56	5.63	0.00	5.63	4216.371	0.085	1.15
W15	5.19	-0.41	5.60	5.63	0.00	5.63	4216.365	0.073	1.19

Ref.

Performance described page 2 to 5 were measured with IC No. 107

Frequency Correlation Data

Sample No.	μ PD780032A Fosc [kHz]	CD4069UBE Fosc [kHz]	Shift [%]
1	4216.332	4200.790	0.3700
2	4200.494	4185.329	0.3624
3	4202.359	4186.862	0.3701
4	4204.464	4188.815	0.3736
5	4203.591	4188.158	0.3685
\bar{X}	4205.448	4189.991	0.3689

muRata Standard Circuit

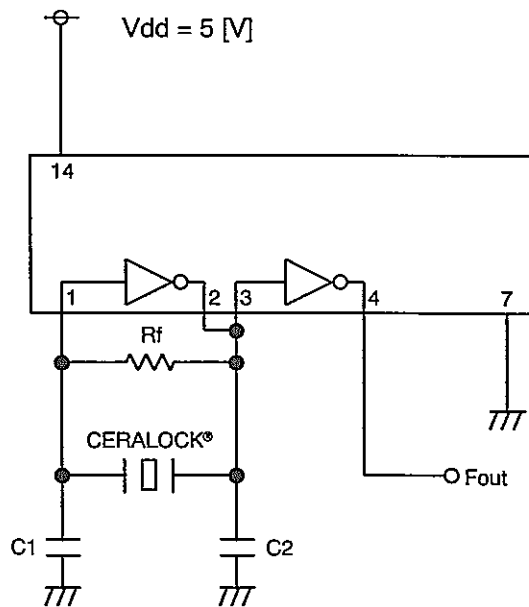

CERALOCK® : CSA4.19MG

C1 = 30 [pF]

C2 = 30 [pF]

Rf = 1 [Mohm]

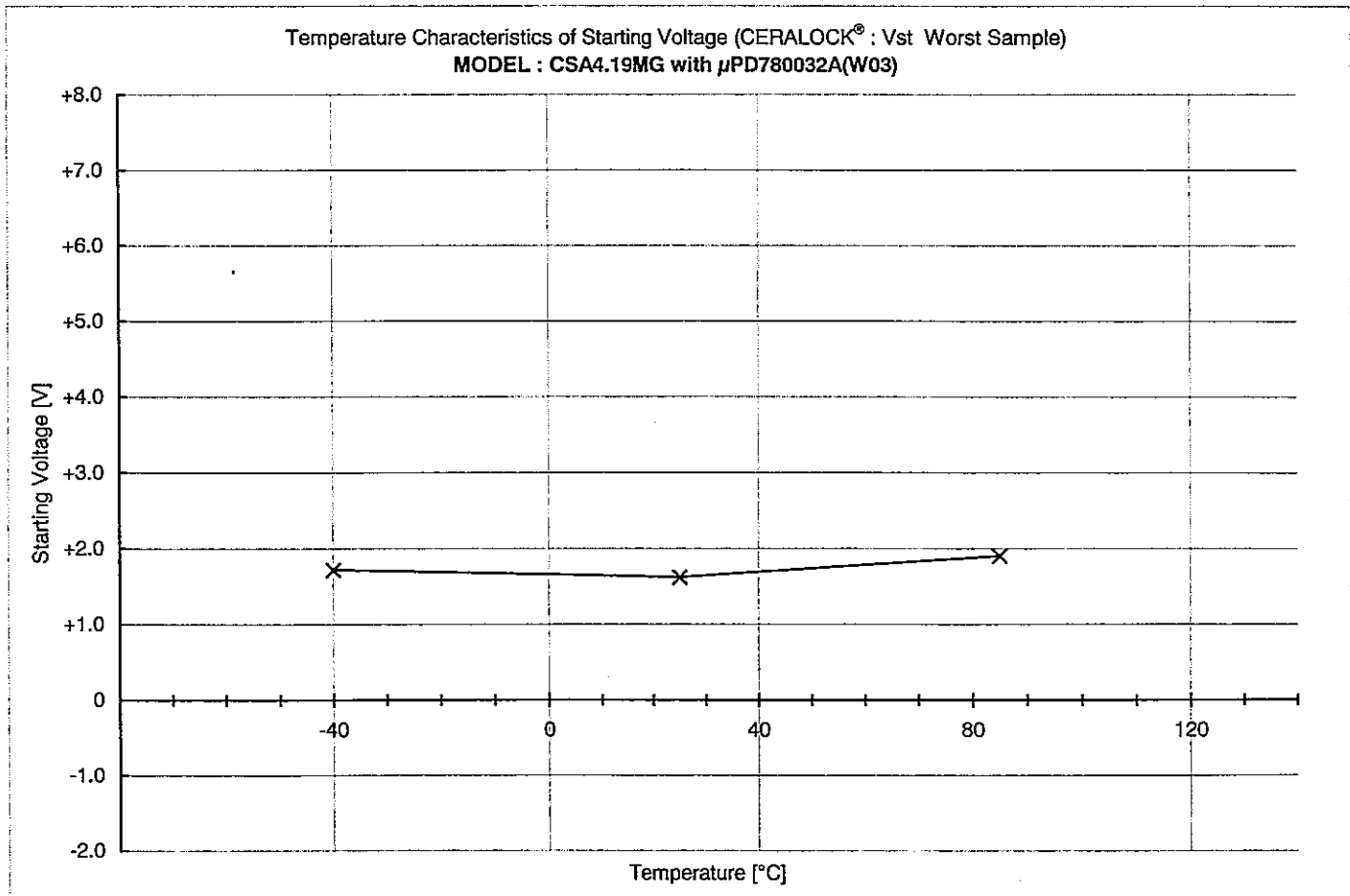
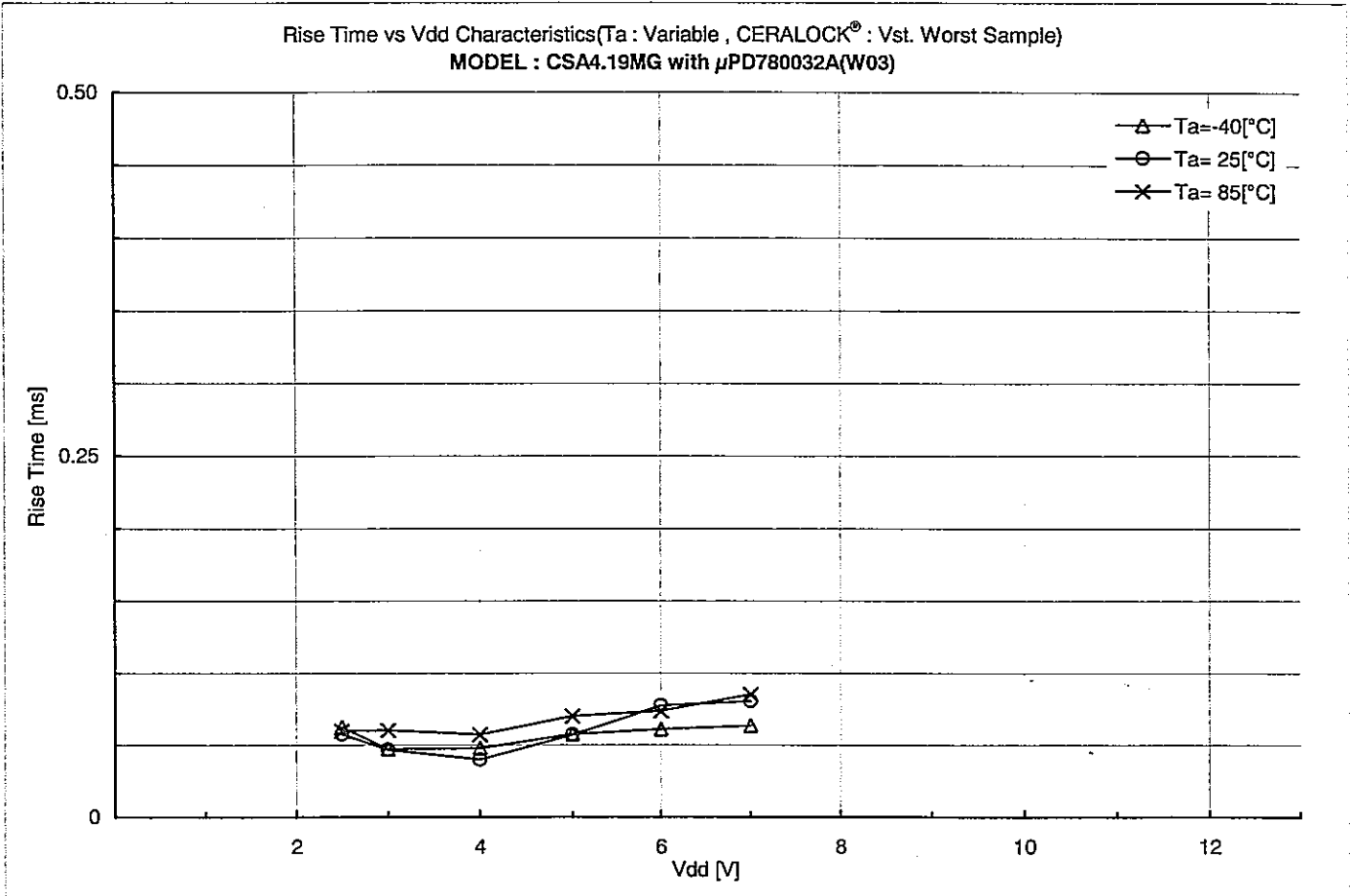

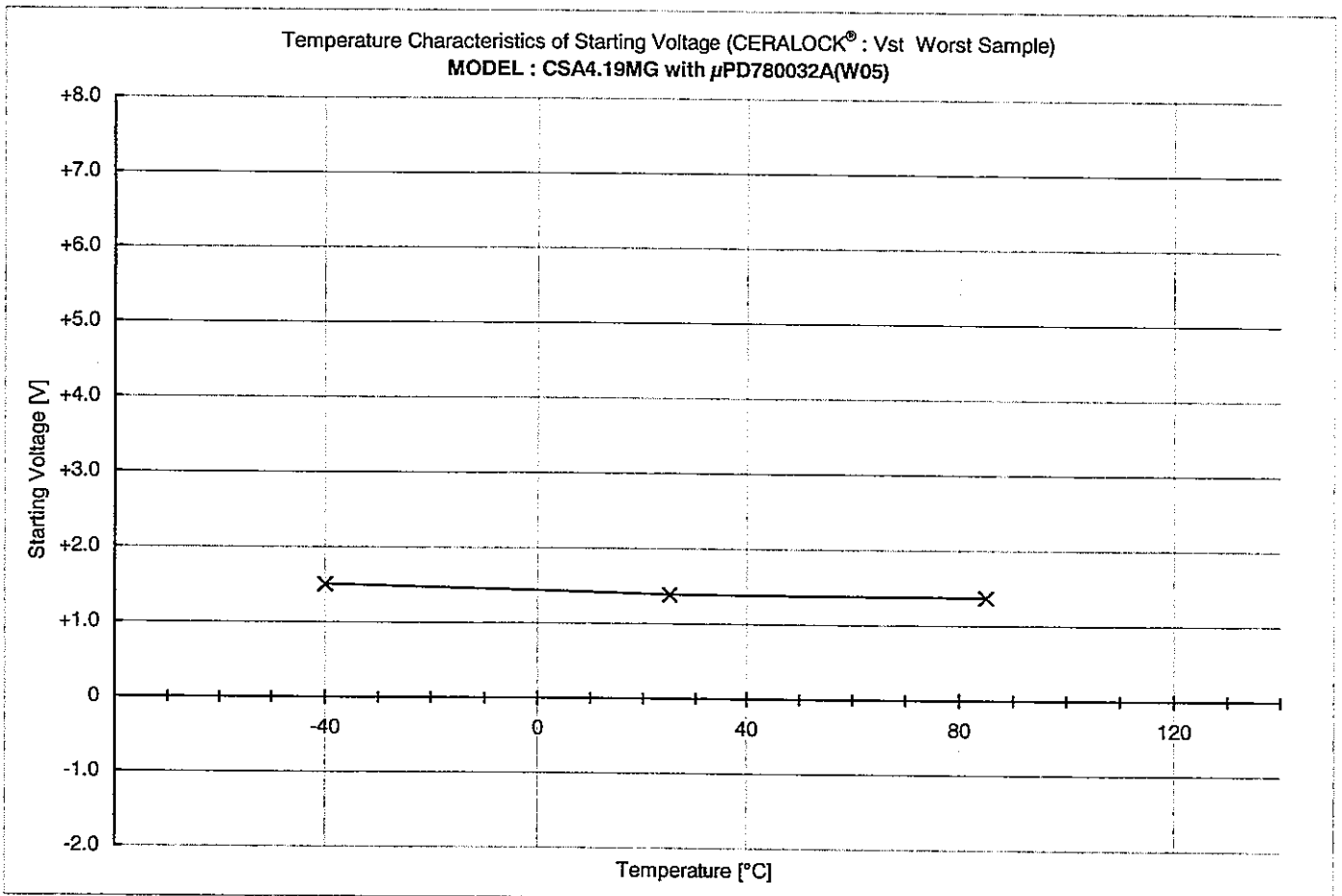
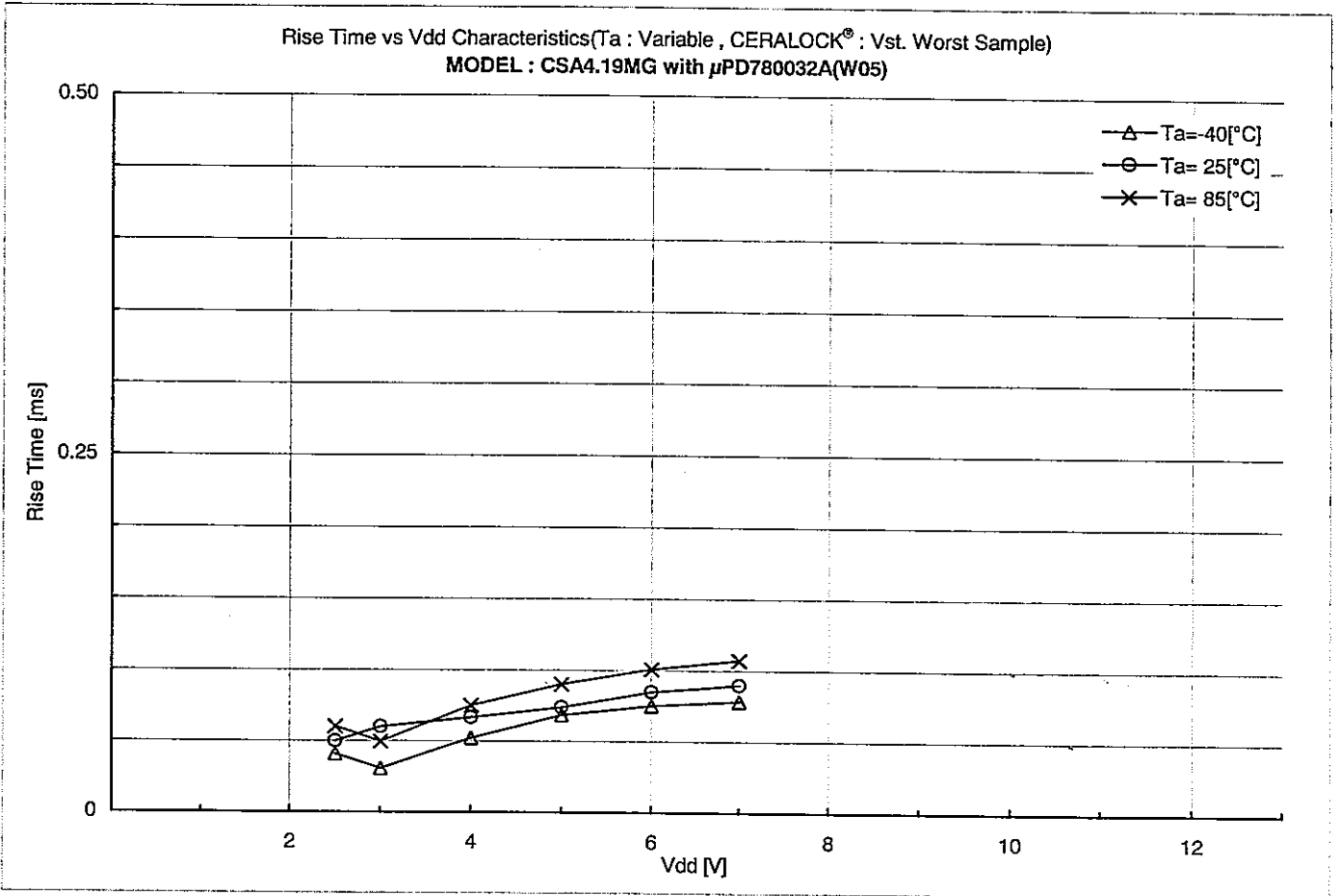

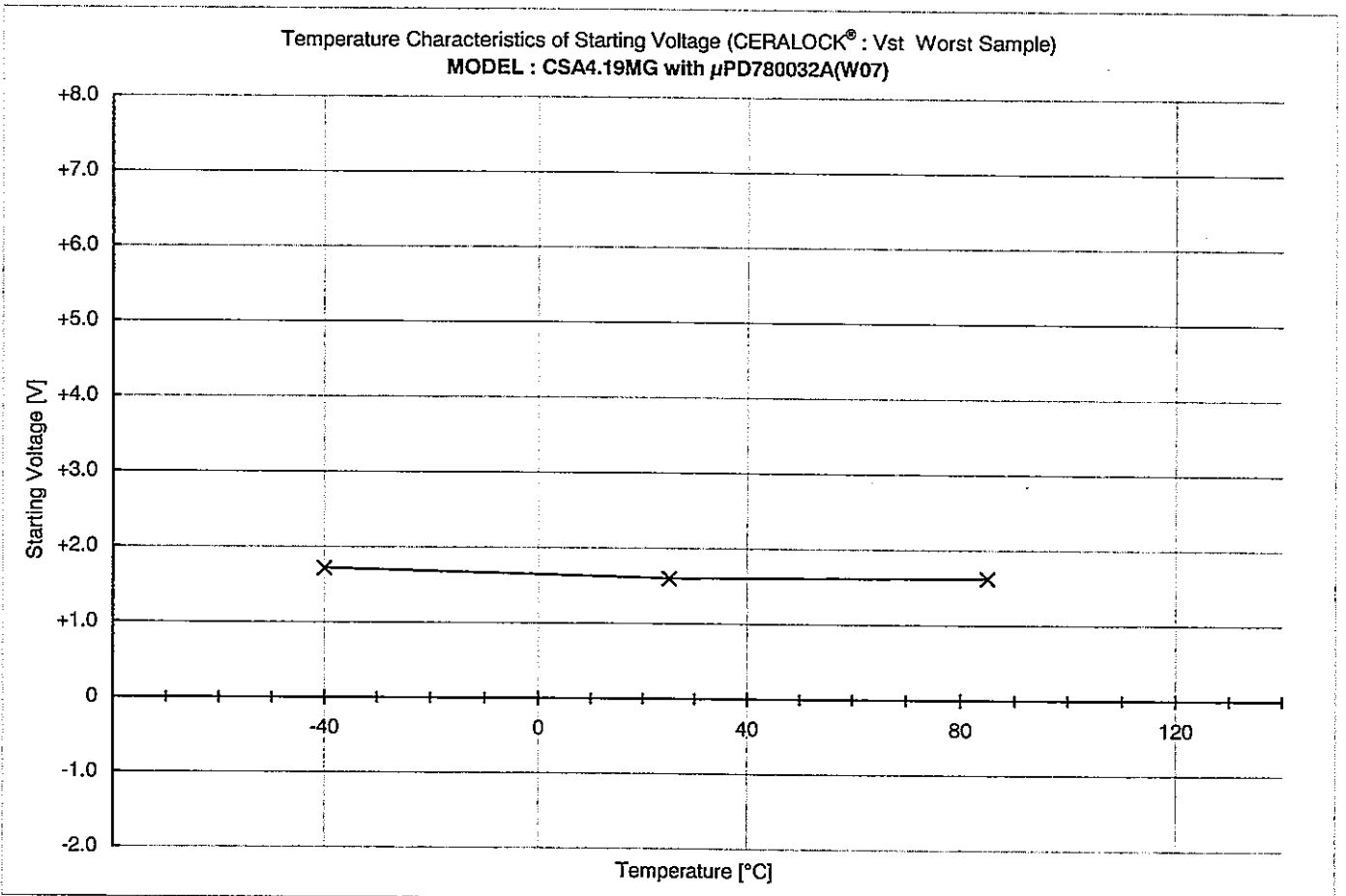
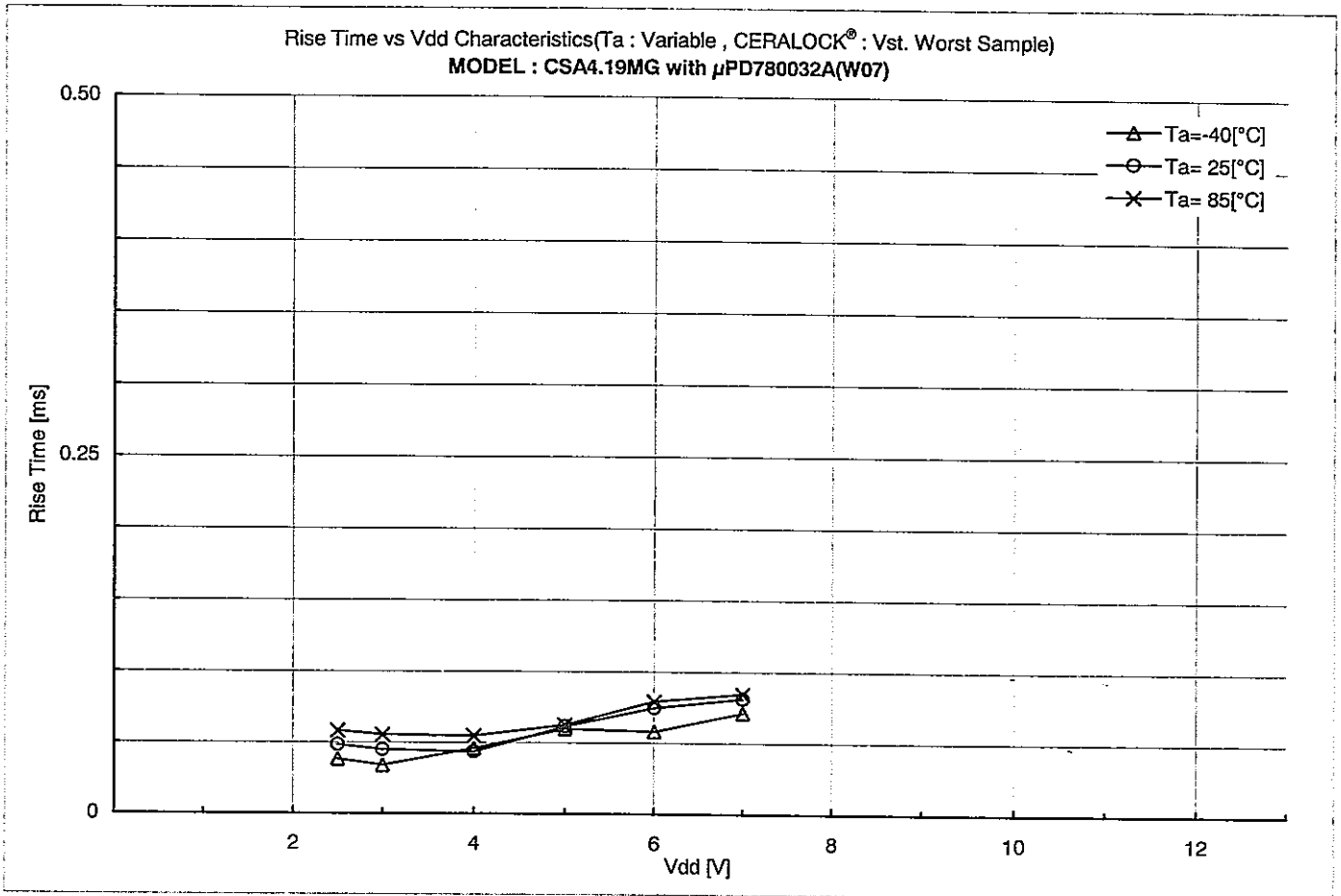

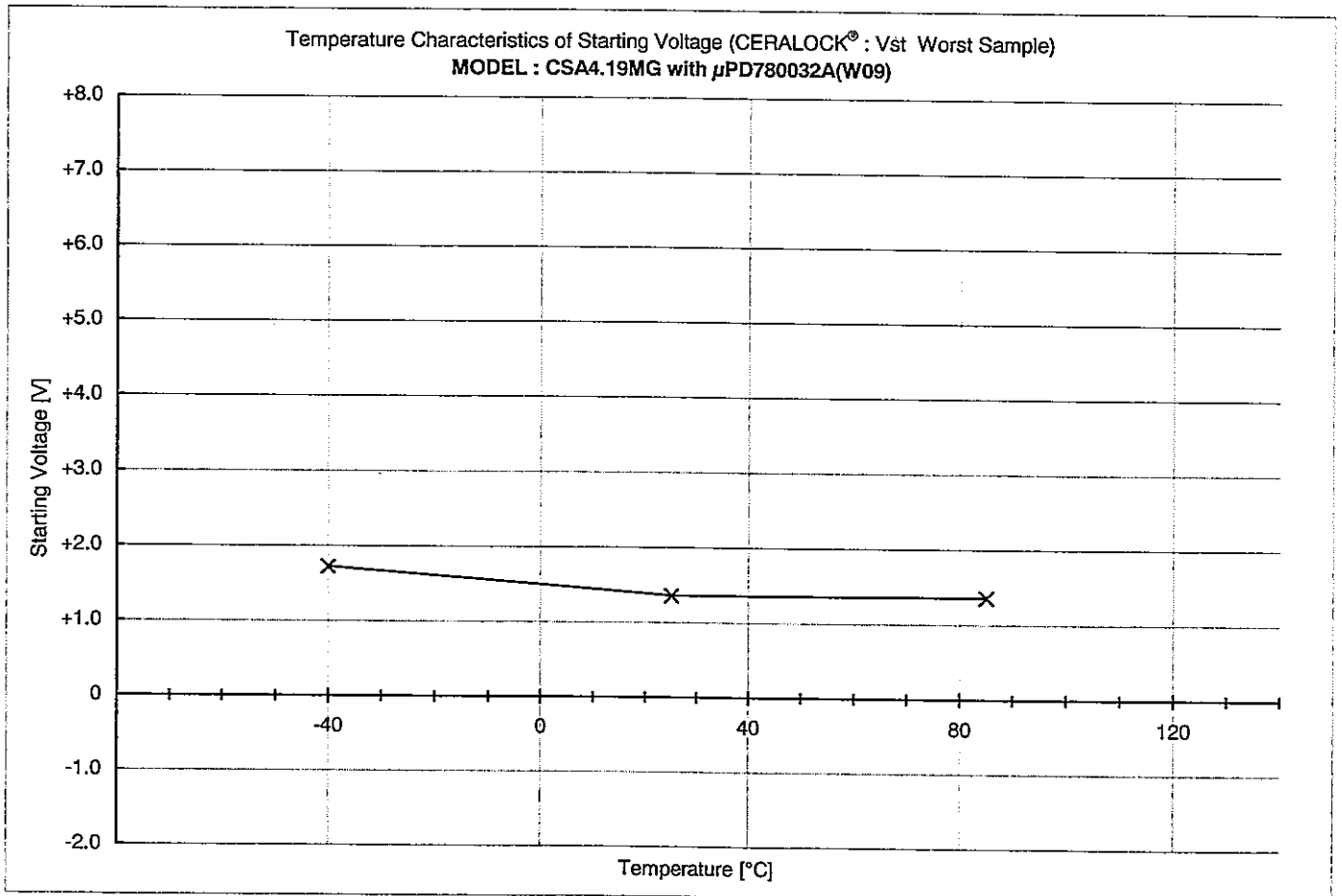
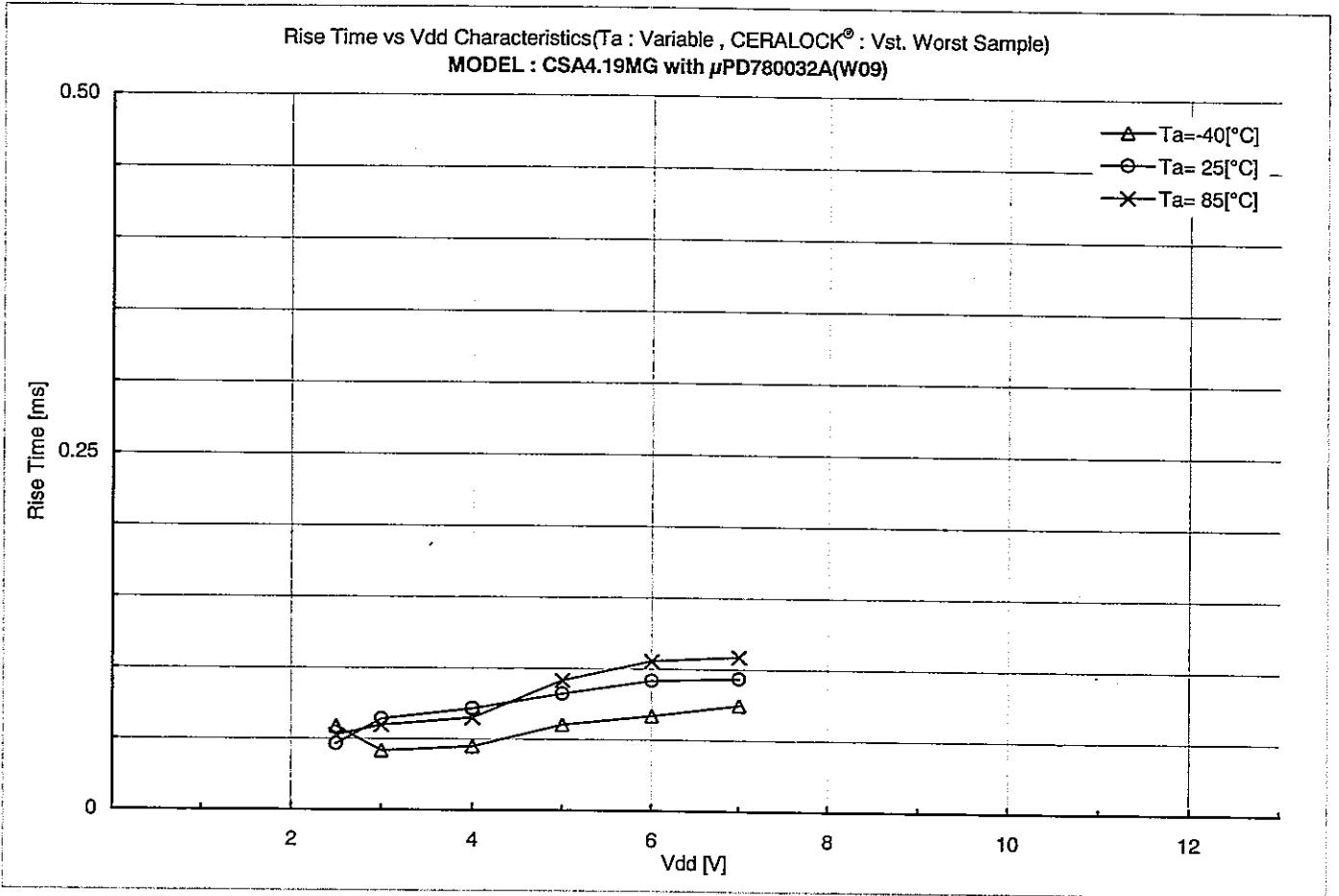

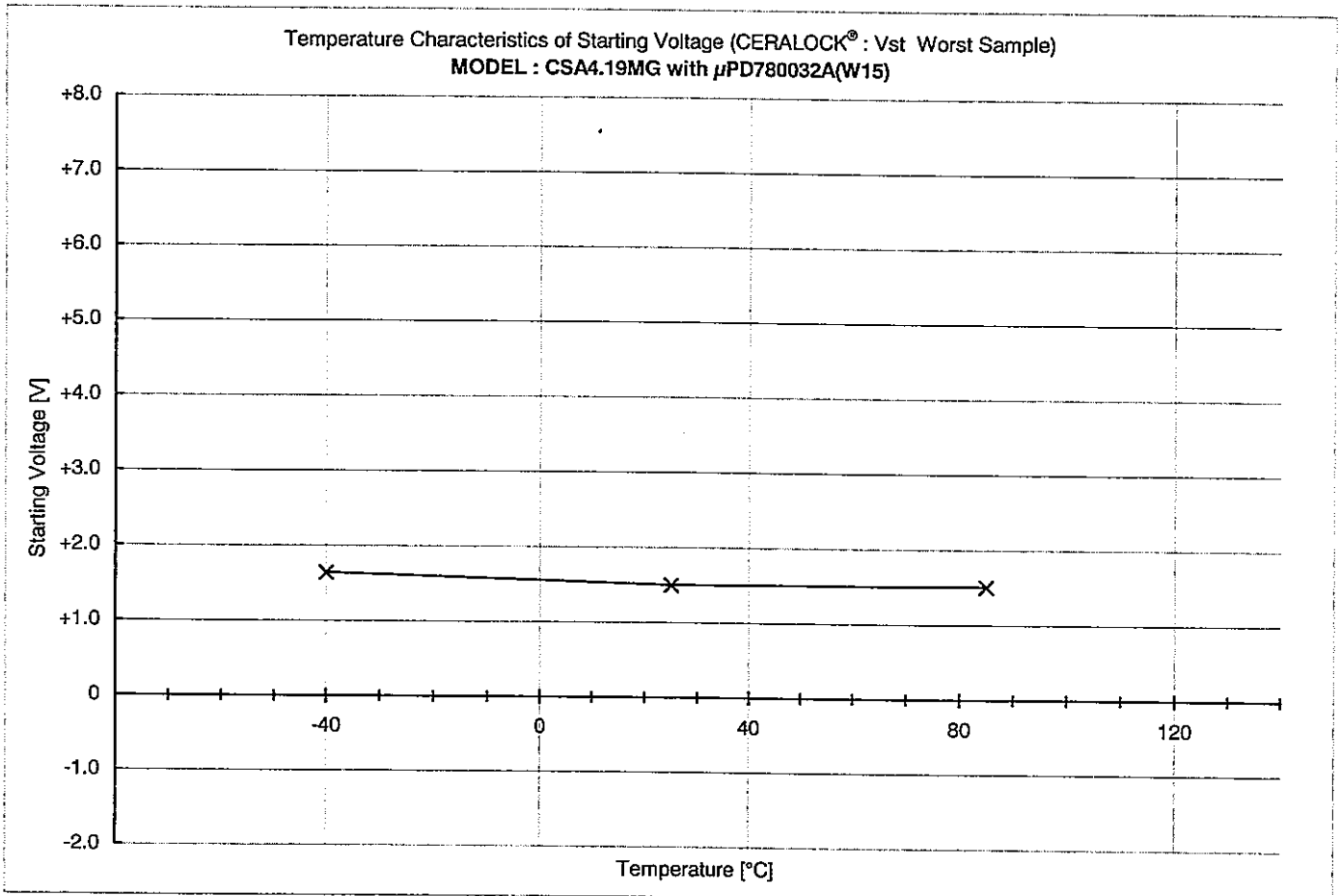
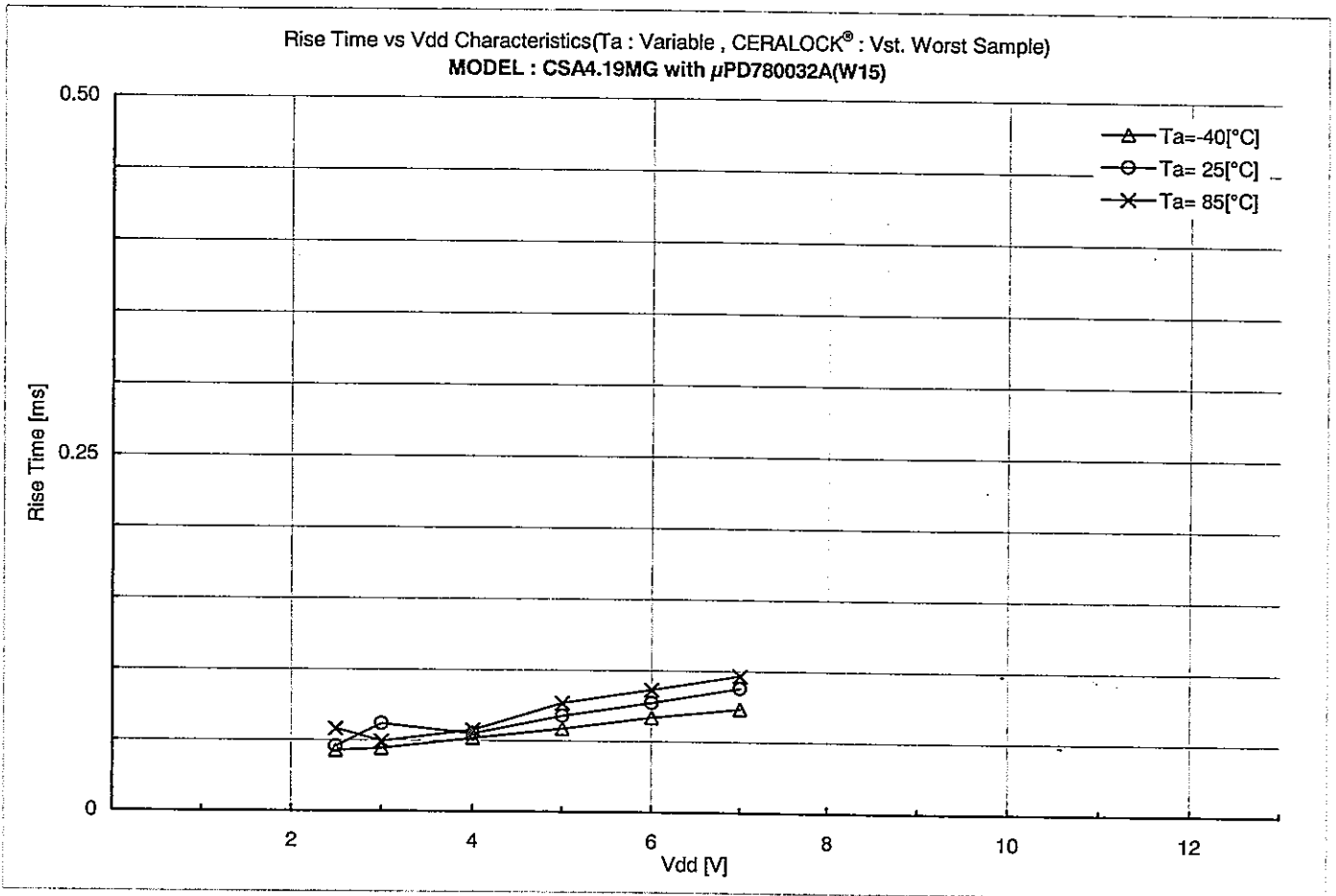

Rs vs Vdd Characteristics
MODEL : CSA4.19MG with uPD780032A

C1=C2=30[pF]

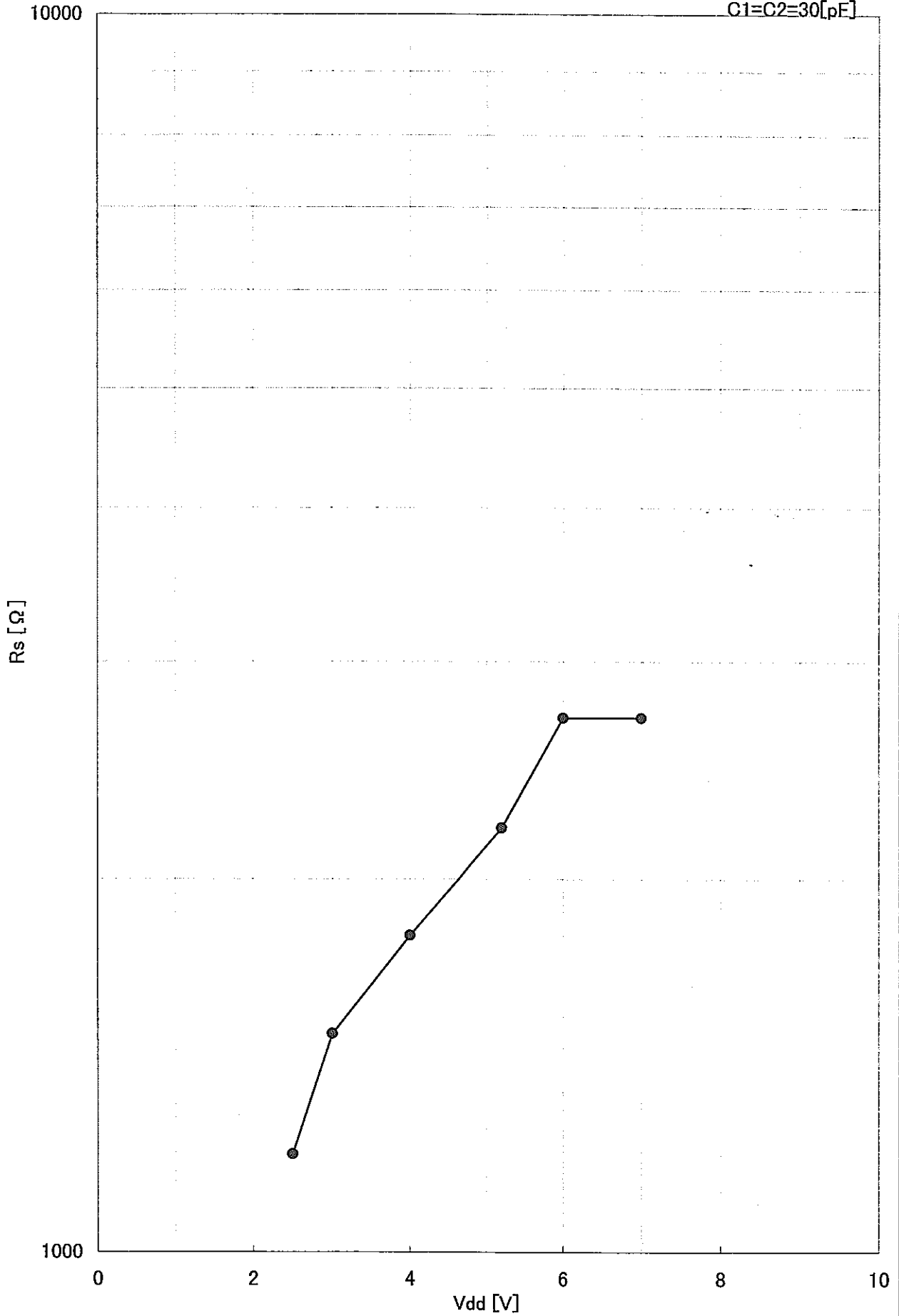

Rs vs C(C1=C2) Characteristics

MODEL : CSA4.19MG with uPD780032A

Vdd=+5.0V

