

To our customers,

Old Company Name in Catalogs and Other Documents

On April 1st, 2010, NEC Electronics Corporation merged with Renesas Technology Corporation, and Renesas Electronics Corporation took over all the business of both companies. Therefore, although the old company name remains in this document, it is a valid Renesas Electronics document. We appreciate your understanding.

Renesas Electronics website: <http://www.renesas.com>

April 1st, 2010
Renesas Electronics Corporation

Issued by: Renesas Electronics Corporation (<http://www.renesas.com>)

Send any inquiries to <http://www.renesas.com/inquiry>.

Notice

1. All information included in this document is current as of the date this document is issued. Such information, however, is subject to change without any prior notice. Before purchasing or using any Renesas Electronics products listed herein, please confirm the latest product information with a Renesas Electronics sales office. Also, please pay regular and careful attention to additional and different information to be disclosed by Renesas Electronics such as that disclosed through our website.
2. Renesas Electronics does not assume any liability for infringement of patents, copyrights, or other intellectual property rights of third parties by or arising from the use of Renesas Electronics products or technical information described in this document. No license, express, implied or otherwise, is granted hereby under any patents, copyrights or other intellectual property rights of Renesas Electronics or others.
3. You should not alter, modify, copy, or otherwise misappropriate any Renesas Electronics product, whether in whole or in part.
4. Descriptions of circuits, software and other related information in this document are provided only to illustrate the operation of semiconductor products and application examples. You are fully responsible for the incorporation of these circuits, software, and information in the design of your equipment. Renesas Electronics assumes no responsibility for any losses incurred by you or third parties arising from the use of these circuits, software, or information.
5. When exporting the products or technology described in this document, you should comply with the applicable export control laws and regulations and follow the procedures required by such laws and regulations. You should not use Renesas Electronics products or the technology described in this document for any purpose relating to military applications or use by the military, including but not limited to the development of weapons of mass destruction. Renesas Electronics products and technology may not be used for or incorporated into any products or systems whose manufacture, use, or sale is prohibited under any applicable domestic or foreign laws or regulations.
6. Renesas Electronics has used reasonable care in preparing the information included in this document, but Renesas Electronics does not warrant that such information is error free. Renesas Electronics assumes no liability whatsoever for any damages incurred by you resulting from errors in or omissions from the information included herein.
7. Renesas Electronics products are classified according to the following three quality grades: “Standard”, “High Quality”, and “Specific”. The recommended applications for each Renesas Electronics product depends on the product’s quality grade, as indicated below. You must check the quality grade of each Renesas Electronics product before using it in a particular application. You may not use any Renesas Electronics product for any application categorized as “Specific” without the prior written consent of Renesas Electronics. Further, you may not use any Renesas Electronics product for any application for which it is not intended without the prior written consent of Renesas Electronics. Renesas Electronics shall not be in any way liable for any damages or losses incurred by you or third parties arising from the use of any Renesas Electronics product for an application categorized as “Specific” or for which the product is not intended where you have failed to obtain the prior written consent of Renesas Electronics. The quality grade of each Renesas Electronics product is “Standard” unless otherwise expressly specified in a Renesas Electronics data sheets or data books, etc.
 - “Standard”: Computers; office equipment; communications equipment; test and measurement equipment; audio and visual equipment; home electronic appliances; machine tools; personal electronic equipment; and industrial robots.
 - “High Quality”: Transportation equipment (automobiles, trains, ships, etc.); traffic control systems; anti-disaster systems; anti-crime systems; safety equipment; and medical equipment not specifically designed for life support.
 - “Specific”: Aircraft; aerospace equipment; submersible repeaters; nuclear reactor control systems; medical equipment or systems for life support (e.g. artificial life support devices or systems), surgical implantations, or healthcare intervention (e.g. excision, etc.), and any other applications or purposes that pose a direct threat to human life.
8. You should use the Renesas Electronics products described in this document within the range specified by Renesas Electronics, especially with respect to the maximum rating, operating supply voltage range, movement power voltage range, heat radiation characteristics, installation and other product characteristics. Renesas Electronics shall have no liability for malfunctions or damages arising out of the use of Renesas Electronics products beyond such specified ranges.
9. Although Renesas Electronics endeavors to improve the quality and reliability of its products, semiconductor products have specific characteristics such as the occurrence of failure at a certain rate and malfunctions under certain use conditions. Further, Renesas Electronics products are not subject to radiation resistance design. Please be sure to implement safety measures to guard them against the possibility of physical injury, and injury or damage caused by fire in the event of the failure of a Renesas Electronics product, such as safety design for hardware and software including but not limited to redundancy, fire control and malfunction prevention, appropriate treatment for aging degradation or any other appropriate measures. Because the evaluation of microcomputer software alone is very difficult, please evaluate the safety of the final products or system manufactured by you.
10. Please contact a Renesas Electronics sales office for details as to environmental matters such as the environmental compatibility of each Renesas Electronics product. Please use Renesas Electronics products in compliance with all applicable laws and regulations that regulate the inclusion or use of controlled substances, including without limitation, the EU RoHS Directive. Renesas Electronics assumes no liability for damages or losses occurring as a result of your noncompliance with applicable laws and regulations.
11. This document may not be reproduced or duplicated, in any form, in whole or in part, without prior written consent of Renesas Electronics.
12. Please contact a Renesas Electronics sales office if you have any questions regarding the information contained in this document or Renesas Electronics products, or if you have any other inquiries.

(Note 1) “Renesas Electronics” as used in this document means Renesas Electronics Corporation and also includes its majority-owned subsidiaries.

(Note 2) “Renesas Electronics product(s)” means any product developed or manufactured by or for Renesas Electronics.

M3028BT2-CPE

User's Manual

Compact Emulator for M16C/Tiny Series

Notes regarding these materials

1. This document is provided for reference purposes only so that Renesas customers may select the appropriate Renesas products for their use. Renesas neither makes warranties or representations with respect to the accuracy or completeness of the information contained in this document nor grants any license to any intellectual property rights or any other rights of Renesas or any third party with respect to the information in this document.
2. Renesas shall have no liability for damages or infringement of any intellectual property or other rights arising out of the use of any information in this document, including, but not limited to, product data, diagrams, charts, programs, algorithms, and application circuit examples.
3. You should not use the products or the technology described in this document for the purpose of military applications such as the development of weapons of mass destruction or for the purpose of any other military use. When exporting the products or technology described herein, you should follow the applicable export control laws and regulations, and procedures required by such laws and regulations.
4. All information included in this document such as product data, diagrams, charts, programs, algorithms, and application circuit examples, is current as of the date this document is issued. Such information, however, is subject to change without any prior notice. Before purchasing or using any Renesas products listed in this document, please confirm the latest product information with a Renesas sales office. Also, please pay regular and careful attention to additional and different information to be disclosed by Renesas such as that disclosed through our website. (<http://www.renesas.com>)
5. Renesas has used reasonable care in compiling the information included in this document, but Renesas assumes no liability whatsoever for any damages incurred as a result of errors or omissions in the information included in this document.
6. When using or otherwise relying on the information in this document, you should evaluate the information in light of the total system before deciding about the applicability of such information to the intended application. Renesas makes no representations, warranties or guaranties regarding the suitability of its products for any particular application and specifically disclaims any liability arising out of the application and use of the information in this document or Renesas products.
7. With the exception of products specified by Renesas as suitable for automobile applications, Renesas products are not designed, manufactured or tested for applications or otherwise in systems the failure or malfunction of which may cause a direct threat to human life or create a risk of human injury or which require especially high quality and reliability such as safety systems, or equipment or systems for transportation and traffic, healthcare, combustion control, aerospace and aeronautics, nuclear power, or undersea communication transmission. If you are considering the use of our products for such purposes, please contact a Renesas sales office beforehand. Renesas shall have no liability for damages arising out of the uses set forth above.
8. Notwithstanding the preceding paragraph, you should not use Renesas products for the purposes listed below:
 - (1) artificial life support devices or systems
 - (2) surgical implantations
 - (3) healthcare intervention (e.g., excision, administration of medication, etc.)
 - (4) any other purposes that pose a direct threat to human lifeRenesas shall have no liability for damages arising out of the uses set forth in the above and purchasers who elect to use Renesas products in any of the foregoing applications shall indemnify and hold harmless Renesas Technology Corp., its affiliated companies and their officers, directors, and employees against any and all damages arising out of such applications.
9. You should use the products described herein within the range specified by Renesas, especially with respect to the maximum rating, operating supply voltage range, movement power voltage range, heat radiation characteristics, installation and other product characteristics. Renesas shall have no liability for malfunctions or damages arising out of the use of Renesas products beyond such specified ranges.
10. Although Renesas endeavors to improve the quality and reliability of its products, IC products have specific characteristics such as the occurrence of failure at a certain rate and malfunctions under certain use conditions. Please be sure to implement safety measures to guard against the possibility of physical injury, and injury or damage caused by fire in the event of the failure of a Renesas product, such as safety design for hardware and software including but not limited to redundancy, fire control and malfunction prevention, appropriate treatment for aging degradation or any other applicable measures. Among others, since the evaluation of microcomputer software alone is very difficult, please evaluate the safety of the final products or system manufactured by you.
11. In case Renesas products listed in this document are detached from the products to which the Renesas products are attached or affixed, the risk of accident such as swallowing by infants and small children is very high. You should implement safety measures so that Renesas products may not be easily detached from your products. Renesas shall have no liability for damages arising out of such detachment.
12. This document may not be reproduced or duplicated, in any form, in whole or in part, without prior written approval from Renesas.
13. Please contact a Renesas sales office if you have any questions regarding the information contained in this document, Renesas semiconductor products, or if you have any other inquiries.

Regulatory Compliance Notices

European Union regulatory notices on Electromagnetic compatibility

CE Certifications:

This product complies with the following European EMC standards.

- EMC Directive 2004/108/EC
EN 55022 Class A

WARNING: This is a Class A product. In a domestic environment this product may cause radio interference in which case the user may be required to take adequate measures.

EN 55024

Information for traceability:

- Authorised representative
 - Name: Renesas Technology Corp.
 - Address: Nippon Bldg., 2-6-2, Ote-machi, Chiyoda-ku, Tokyo 100-0004, Japan
- Manufacturer
 - Name: Renesas Solutions Corp.
 - Address: Nippon Bldg., 2-6-2, Ote-machi, Chiyoda-ku, Tokyo 100-0004, Japan
- Person responsible for placing on the market
 - Name: Renesas Technology Europe Limited European Headquarters
 - Address: Dukes Meadow, Millboard Road, Bourne End, Buckinghamshire, SL8 5FH, U.K.

United States Regulatory notices on Electromagnetic compatibility

FCC Certifications:

This equipment has been tested and found to comply with the limits for a Class A digital device, pursuant to Part 15 of the FCC Rules. These limits are designed to provide reasonable protection against harmful interference when the equipment is operated in a commercial environment. This equipment generates, uses, and can radiate radio frequency energy and, if not installed and used in accordance with the instruction manual, may cause harmful interference to radio communications. Operation of this equipment in a residential area is likely to cause harmful interference in which case the user will be required to correct the interference at his own expense.

This device complies with Part 15 of the FCC Rules. Operation is subject to the following two conditions: (1) this device may not cause harmful interference, and (2) this device must accept any interference received, including interference that may cause undesired operation.

CAUTION: Changes or modifications not expressly approved by the party responsible for compliance could void the user's authority to operate the equipment.

Preface

The M3028BT2-CPE is a compact emulator for the M16C/Tiny Series MCUs with the real-time trace function.

This user's manual mainly describes specifications of the M3028BT2-CPE compact emulator and how to setup it. For details on the emulator debugger and C compiler package M3T-NC30WA evaluation version (C compiler NC30, assembler AS30 and integrated development environment High-performance Embedded Workshop), which are included with the M3028BT2-CPE, refer to the online manual.

All the components of this product are shown in "1.1 Package Components" (page 14). If there is any question or doubt about this product, contact your local distributor.

The related manuals for using this product are listed below. You can download the latest manuals from the Renesas Tools homepage (<http://www.renesas.com/tools>).

Related manuals

Item	Manual
Accessory tools	M30263T-42SSB User's Manual
	M30260T-48FPD User's Manual
	M30291T-64FPD User's Manual
	M30290T-80FPD User's Manual
	M30280T-85LGF User's Manual
Integrated development environment	High-performance Embedded Workshop User's Manual
Emulator debugger	M16C R8C Compact Emulator Debugger User's Manual
C compiler	C Compiler Package for M16C Series and R8C Family C Compiler User's Manual
Assembler	C Compiler Package for M16C Series and R8C Family Assembler User's Manual

Important

Before using this product, be sure to read this user's manual carefully.

Keep this user's manual, and refer to this when you have questions about this product.

Emulator:

The emulator in this document refers to the following products that are manufactured by Renesas Technology Corp.:

- (1) Compact emulator main unit
- (2) Package converter board for connecting the user system

The emulator herein does not include the customer's user system and host machine.

Purpose of use of the emulator:

This emulator is a device to support the development of a system that uses the M16C Family M16C/Tiny Series of Renesas 16-bit single-chip MCUs. It provides support for system development in both software and hardware.

Be sure to use this emulator correctly according to said purpose of use. Please avoid using this emulator for other than its intended purpose of use.

For those who use this emulator:

This emulator can only be used by those who have carefully read the user's manual and know how to use it.

Use of this emulator requires the basic knowledge of electric circuits, logical circuits, and MCUs.

When using the emulator:

- (1) This product is a development supporting unit for use in your program development and evaluation stages. In mass-producing your program you have finished developing, be sure to make a judgment on your own risk that it can be put to practical use by performing integration test, evaluation, or some experiment else.
- (2) In no event shall Renesas Solutions Corp. be liable for any consequence arising from the use of this product.
- (3) Renesas Solutions Corp. strives to renovate or provide a workaround for product malfunction at some charge or without charge. However, this does not necessarily mean that Renesas Solutions Corp. guarantees the renovation or the provision under any circumstances.
- (4) This product has been developed by assuming its use for program development and evaluation in laboratories. Therefore, it does not fall under the application of Electrical Appliance and Material Safety Law and protection against electromagnetic interference when used in Japan.
- (5) Renesas Solutions Corp. cannot predict all possible situations or possible cases of misuse where a potential danger exists. Therefore, the warnings written in this user's manual and the warning labels attached to this emulator do not necessarily cover all of such possible situations or cases. Please be sure to use this emulator correctly and safely on your own responsibility.

Usage restrictions:

This emulator has been developed as a means of supporting system development by users. Therefore, do not use it as a device used for equipment-embedded applications. Also, do not use it for developing the systems or equipment used for the following purposes either:

- (1) Transportation and vehicular
- (2) Medical (equipment where human life is concerned)
- (3) Aerospace
- (4) Nuclear power control
- (5) Undersea repeater

If you are considering the use of this emulator for one of the above purposes, please be sure to consult your local distributor.

About product changes:

We are constantly making efforts to improve the design and performance of this emulator. Therefore, the specification or design of this emulator or its user's manual may be changed without prior notice.

About the rights:

- (1) We assume no responsibility for any damage or infringement on patent rights or any other rights arising from the use of any information, products or circuits presented in this user's manual.
- (2) The information or data in this user's manual does not implicitly or otherwise grant a license for patent rights or any other rights belonging to us or third parties.
- (3) This user's manual and this emulator are copyrighted, with all rights reserved by us. This user's manual may not be copied, duplicated or reproduced, in whole or part, without prior written consent of us.

About diagrams:

The diagrams in this user's manual may not all represent exactly the actual object.

Precautions for Safety

Definitions of Signal Words

In both the user's manual and on the product itself, several icons are used to insure proper handling of this product and also to prevent injuries to you or other persons, or damage to your properties.

This chapter describes the precautions which should be taken in order to use this product safely and properly. Be sure to read this chapter before using this product.



This symbol represents a warning about safety. It is used to arouse caution about a potential danger that will possibly inflict an injury on persons. To avoid a possible injury or death, please be sure to observe the safety message that follows this symbol.



DANGER

DANGER indicates an imminently dangerous situation that will cause death or heavy wound unless it is avoided. However, there are no instances of such danger for the product presented in this user's manual.



WARNING

WARNING indicates a potentially dangerous situation that will cause death or heavy wound unless it is avoided.



CAUTION

CAUTION indicates a potentially dangerous situation that will cause a slight injury or a medium-degree injury unless it is avoided.

CAUTION

CAUTION with no safety warning symbols attached indicates a potentially dangerous situation that will cause property damage unless it is avoided.

IMPORTANT

This is used in operation procedures or explanatory descriptions to convey exceptional conditions or cautions to the user.

In addition to the five above, the following are also used as appropriate.

△ means WARNING or CAUTION.

Example:



CAUTION AGAINST AN ELECTRIC SHOCK

⊘ means PROHIBITION.

Example:



DISASSEMBLY PROHIBITED

● means A FORCIBLE ACTION.

Example:



UNPLUG THE POWER CABLE FROM THE RECEPTACLE.

⚠ WARNING

Warnings for AC Power Supply:



- This product is connected signal ground with frame ground. If your developing product is transformless (not having isolation transformer of AC power), this may cause electric shock. Also, this may give an unreparable damage to this product and your developing one.

While developing, connect AC power of the product to commercial power through isolation transformer in order to avoid these dangers.

- If other equipment is connected to the same branch circuit, care should be taken not to overload the circuit.
- Use the power supply which complies with CE marking requirements.



- When installing this equipment, insure that a reliable ground connection is maintained.



- If you smell a strange odor, hear an unusual sound, or see smoke coming from this product, then disconnect power immediately by unplugging the AC power cable from the outlet.

Do not use this as it is because of the danger of electric shock and/or fire. In this case, contact your local distributor.

- Before setting up this emulator and connecting it to other devices, turn off power or remove a power cable to prevent injury or product damage.

Warnings to Be Taken for This Product:



- Do not disassemble or modify this product. Personal injury due to electric shock may occur if this product is disassembled and modified. Disassembling and modifying the product will void your warranty.

- Make sure nothing falls into the cooling fan on the top panel, especially liquids, metal objects, or anything combustible.

Warning for Installation:



- Do not set this product in water or areas of high humidity. Make sure that the product does not get wet. Spilling water or some other liquid into the product may cause unreparable damage.

Warning for Use Environment:



- This equipment is to be used in an environment with a maximum ambient temperature of 35°C. Care should be taken that this temperature is not exceeded.

 **CAUTION****Notes on Connecting the Power Supply of the Emulator:**

- Do not use any power cable other than the one that is included with the product.
- The power cable included with the product has its positive and negative poles color-coded by red and black, respectively.
- Pay attention to the polarities of the power supply. If its positive and negative poles are connected in reverse, the internal circuit may be broken.
- Do not apply any voltages exceeding the product's rated power supply voltage (5.0V \pm 5%). Extreme voltages may cause a burn due to abnormal heat or cause the internal circuit to break down.

Cautions to Be Taken for Turning On the Power:

- Turn ON/OFF the power of the emulator and user system as simultaneously as possible.
- Do not leave either the emulator or user system powered on, because of leakage current the internal circuits may be damaged.
- When turning on the power again after shutting off the power, wait about 10 seconds.

Cautions to Be Taken for Handling This Product:

- Use caution when handling the main unit. Be careful not to apply a mechanical shock.
- Do not touch the connector pins of the emulator main unit and the target MCU connector pins directly. Static electricity may damage the internal circuits.
- Do not pull this emulator by the communications interface cable or the flexible cable for connecting the user system. And, excessive flexing or force may break conductors.

Caution to Be Taken for System Malfunctions:

- If the emulator malfunctions because of interference like external noise, do the following to remedy the trouble.
 - (1) Press the RESET button on the emulator upper panel.
 - (2) If normal operation is not restored after step (1), shut OFF the emulator once and then reactivate it.

Contents

	Page
Regulatory Compliance Notices	3
Preface.....	4
Important.....	5
Precautions for Safety	7
Contents.....	10
User Registration	12
Terminology	13
1. Outline.....	14
1.1 Package Components	14
1.2 System Configuration	15
1.2.1 System Configuration	15
1.2.2 Names and Functions of each part of the Emulator.....	16
1.3 Specifications	19
1.4 Operating Environment.....	20
2. Setup.....	21
2.1 Flowchart of Starting Up the Emulator	21
2.2 Installing the Included Software	22
2.3 Attaching the Ferrite Core	22
2.4 Connecting the Power Supply for the Emulator	23
2.5 Connecting the Host Machine	24
2.6 Turning ON the Power.....	25
2.6.1 MCU Power Supply Source Selection Jumper/MCU Power Supply Voltage Selection Jumper.....	25
2.6.2 Checking Connections of the Emulator System.....	26
2.6.3 Power Supply to the User System	26
2.6.4 Turning ON/OFF the Power	26
2.6.5 LED Display When the Emulator Starts Up Normally	27
2.7 Self-check	29
2.7.1 Self-check Procedure	29
2.7.2 If an Error is Detected in the Self-check.....	30
2.8 Connecting the User System.....	31
2.8.1 Connecting to a 42-pin 0.8mm pitch Foot Pattern	32
2.8.2 Connecting to a 48-pin 0.5mm pitch Foot Pattern	33
2.8.3 Connecting to a 64-pin 0.5mm pitch Foot Pattern	34
2.8.4 Connecting to an 80-pin 0.5mm pitch Foot Pattern	35
2.8.5 Connecting to an 85-pin 0.65mm pitch Foot Pattern	36
2.9 Changing Settings	37
2.9.1 MCU Power Supply Source Selection Jumper/MCU Power Supply Voltage Selection Jumper.....	37
2.9.2 Selecting Clock Supply	38
2.9.3 A/D Conversion Bypass Capacitors	42
3. Usage (How to Use the Emulator Debugger)	43
3.1 Starting Up the Emulator Debugger	43
3.2 Init Dialog Box	44
3.3 MCU Setting Dialog Box.....	48
3.4 Checking Connections of the Emulator System.....	50
3.5 Program Execution	51
3.6 Hardware Breakpoint Setting Window.....	56
3.7 Trace Window.....	61
3.8 RAM Monitor Window.....	66

	Page
4. Hardware Specifications	69
4.1 Target MCU Specifications.....	69
4.2 Differences between the Actual MCU and Emulator.....	70
4.3 Connection Diagram.....	73
4.4 External Dimensions.....	74
4.4.1 External Dimensions of the Compact Emulator	74
4.4.2 External Dimensions of the Converter Board M30263T-42SSB.....	75
4.4.3 External Dimensions of the Converter Board M30260T-48FPD.....	75
4.4.4 External Dimensions of the Converter Board M30291T-64FPD.....	76
4.4.5 External Dimensions of the Converter Board M30290T-80FPD.....	76
4.4.6 External Dimensions of the Converter Board M30280T-85LGF	77
4.5 Notes on Using This Product.....	78
5. Troubleshooting	82
5.1 Flowchart to Remedy the Troubles	82
5.2 When the Emulator Debugger Does Not Start Up Properly	83
5.3 How to Request for Support	86
6. Maintenance and Guarantee	87
6.1 User Registration.....	87
6.2 Maintenance	87
6.3 Guarantee.....	87
6.4 Repair Provisions	87
6.5 How to Make Request for Repair	88

User Registration

When you install debugger software, a text file for user registration is created on your PC. Fill it in and email it to your local distributor. If you have replaced an emulator main unit or emulation probe, rewrite an emulator name and serial number in the text file you filled in earlier to register your new hardware products.

Your registered information is used for only after-sale services, and not for any other purposes. Without user registration, you will not be able to receive maintenance services such as a notification of field changes or trouble information. So be sure to carry out the user registration.

For more information about user registration, please contact your local distributor.

Terminology

Some specific words used in this user's manual are defined as follows:

Emulator M3028BT2-CPE

This means the compact emulator (this product) for M16C/Tiny Series MCUs.

Emulator system

This means an emulator system built around the M3028BT2-CPE emulator. The M3028BT2-CPE emulator system is configured with an emulator main unit M3028BT2-CPE, power supply for the emulator, emulator debugger and host machine.

Renesas Integrated development environment High-performance Embedded Workshop

This tool provides powerful support for the development of embedded applications for Renesas microcomputers. It has an emulator debugger function allowing for the emulator to be controlled from the host machine via an interface. Furthermore, it permits a range of operations from editing a project to building and debugging it to be performed within the same application. What's more, it supports version management.

Emulator debugger

This means a software tool which starts up in the integrated development environment High-performance Embedded Workshop to control the compact emulator for the M16C R8C/Tiny Series.

Firmware

This means a program stored in the flash ROM of the emulator. It analyzes contents of communication with the emulator debugger and controls the emulator M3028BT2-CPE. This program is downloadable from the emulator debugger to upgrade the debugger, etc.

Host machine

This means a personal computer used to control the M3028BT2-CPE emulator system.

Target MCU

This means the microcomputer you are going to debug.

User system

This means a user's application system using the microcomputer to be debugged.

User program

This means a user's application program to be debugged.

Evaluation MCU

This means a microcomputer mounted on the emulator which is operated in the special mode for the emulator.

#

In this user's manual, this symbol is used to show active LOW. (e.g. RESET#)

1. Outline

This chapter describes the package components, the system configuration, the specifications and the operating environment of this product.

1.1 Package Components

The M3028BT2-CPE package consists of the following items. When unpacking it, check to see if your M3028BT2-CPE contains all of these items.

Table 1.1 Package components

Item	Quantity
M3028BT2-CPE compact emulator	1
OSC-3 (20MHz) oscillator circuit board	1
OSC-2 oscillator circuit bare board	1
USB interface cable for connecting host machine and emulator	1
Power supply cable for compact emulator	1
Ferrite core for connecting power supply cable	1
H/W Tool Customer Registration Sheet (English)	1
H/W Tool Customer Registration Sheet (Japanese)	1
Repair Request Sheet (English)	1
Repair Request Sheet (Japanese)	1
M3028BT2-CPE User's Manual (this manual)	1
M3028BT2-CPE User's Manual (Japanese)	1
M3028BT2-CPE Release Notes (English)	1
M3028BT2-CPE Release Notes (Japanese)	1
CD-ROM <ul style="list-style-type: none"> • Emulator debugger M16C R8C Compact Emulator Debugger • C compiler package M3T-NC30WA (evaluation version) <ul style="list-style-type: none"> - C compiler for M16C Series and R8C Family NC30 - Assembler for M16C Series and R8C Family AS30 - Integrated development environment High-performance Embedded Workshop 	1

* Please keep the M3028BT2-CPE's packing box and cushion material in your place for reuse at a later time when sending your product for repair or other purposes. Always use these packing box and cushion material when transporting this product.

* If there is any question or doubt about the packaged product, contact your local distributor.

1.2 System Configuration

1.2.1 System Configuration

Figure 1.1 shows a configuration of the M3028BT2-CPE system.

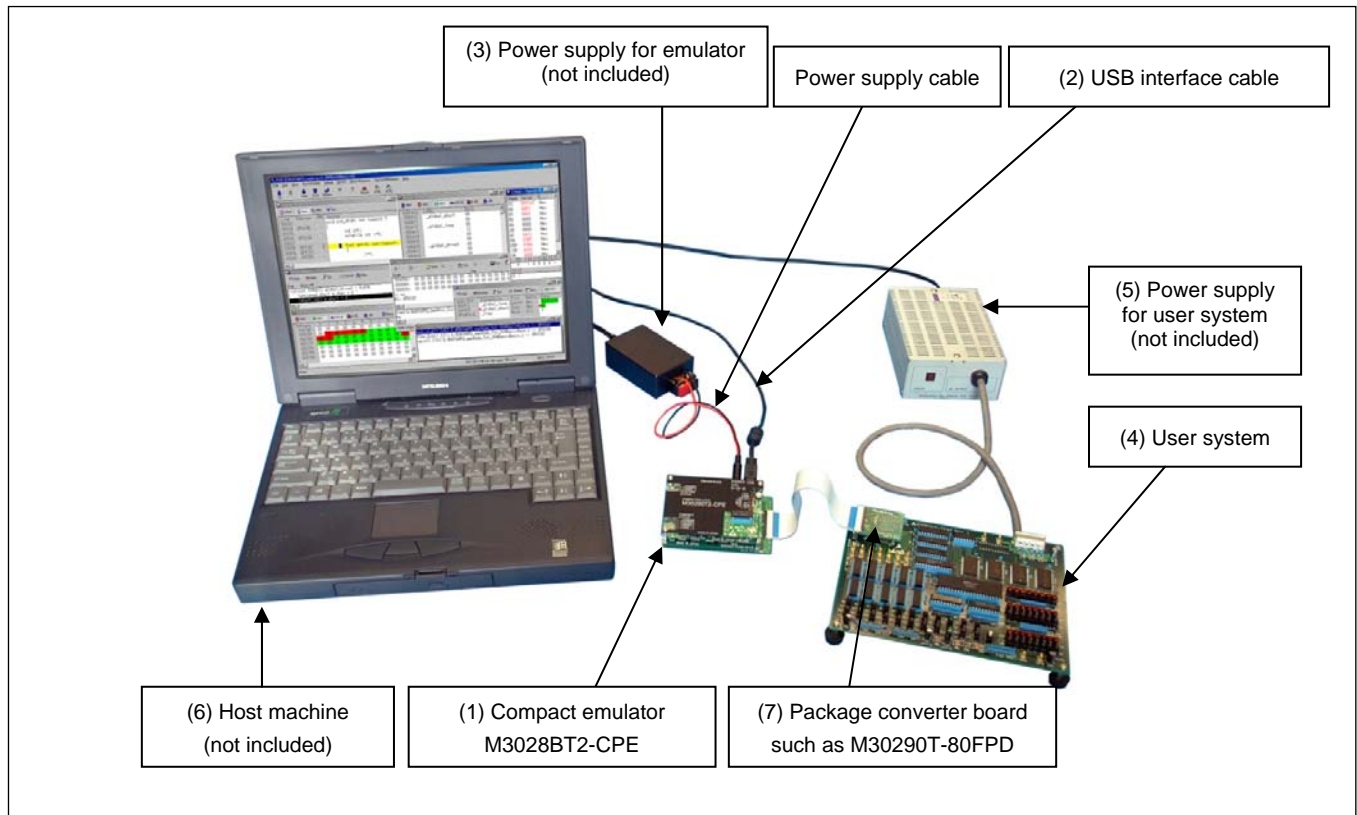

Figure 1.1 System configuration

(1) Compact emulator M3028BT2-CPE (this product)

This is a compact emulator for the M16C/Tiny Series with the real-time trace functions (hereafter, emulator). The M3028BT-EPBM on which an evaluation MCU is mounted can be also purchased separately.

(2) USB interface cable (included)

This is an interface cable for the host machine and the emulator.

(3) Power supply for emulator

This is a power supply for the emulator. Supply 5.0V \pm 5% (DC).

Prepare a power supply which complies with CE marking requirements separately. The power cable is included with this product.

Note: Be aware that there are some AC adapters whose power supply voltage varies rather widely with its load. You are recommended to use an AC adapter with a switching power supply or a stabilized power supply.

(4) User system

This is your application system. This emulator can be used without the user system.

(2) Target Status LEDs

The target status LEDs indicate the target MCU's power supply and operating status.

Table 1.3 lists the definition of each target status LED.

Table 1.3 Definitions of the target status LEDs

Name	Number	Color	Status	Meaning
POWER	LED3	Orange	ON	Power is supplied to the target MCU.
			OFF	Power is not supplied to the target MCU.
CLOCK	LED4	Green	ON	The target MCU internal clock is oscillating.
			OFF	The target MCU internal clock is not oscillating.
RESET	LED5	Red	ON	Target MCU is being reset, or reset signal of the user system is held low.
			OFF	Target MCU is not being reset.
RUN	LED6	Green	ON	User program is being executed.
			OFF	User program is not being executed.

(3) System Reset Switch

By pressing the system reset switch, you can initialize the emulator system.

Table 1.4 shows the functions of the system reset switch depending on the state of the emulator.

Table 1.4 Functions of the system reset switch

State of Emulator	Function
When the user's program is halted	Initializes the emulator and waits for a command from the emulator debugger
When the user's program is executed	Stops the user's program, initializes the emulator, and waits for a command from the emulator debugger.

IMPORTANT

Notes on a System Reset:

- After pressing the system reset switch, restart the emulator debugger. Otherwise the display of emulator debugger and the actual value (in the emulator) may not match.
- When the emulator debugger does not start up normally even after rebooting, turn off the emulator and then turn on again.

(4) Power Connector (J1)

This is a connector for connecting the power supply to this product. For details, refer to "2.4 Connecting the Power Supply for the Emulator" (page 23).

(5) USB Cable Connector (J2)

This is a USB cable connector for connecting the host machine to this product. For details, "2.5 Connecting the Host Machine" (page 24).

(6) MCU Power Supply Source Selection Jumper (JP1)

This is a jumper switch to select the power supply source to the MCU. For details on this switch, see “2.6.1 MCU Power Supply Source Selection Jumper/MCU Power Supply Voltage Selection Jumper” (page 25).

(7) MCU Power Supply Voltage Selection Jumper (JP2)

This is a jumper switch to select the power supply voltage of the MCU. This setting is valid when the MCU power supply source selection jumper is set to INT only. For details on this switch, see “2.6.1 MCU Power Supply Source Selection Jumper/MCU Power Supply Voltage Selection Jumper” (page 25).

1.4 Operating Environment

Be sure to use this emulator with the operating environmental of the emulator and host machine listed in Tables 1.6 and 1.7.

Table 1.6 Operating environmental conditions

Item	Description
Operating temperature	5 to 35°C (no dew)
Storage temperature	-10 to 60°C (no dew)

Table 1.7 Operating environment of the host machine

Item	Description
Host machine	IBM PC/AT compatibles
OS	Windows® XP, Windows® 2000 ^{*1}
CPU	Pentium III 600MHz or more recommended
Host machine interface	USB 1.1 full-speed ^{*2}
Memory	128MB or more recommended
Pointing device such as mouse	Mouse or any other pointing device usable with the above OS that can be connected to the main body of the host machine.
CD drive	Needed to install the emulator debugger or refer to the user's manual

*1 Windows is either a registered trademark or trademark of Microsoft Corporation in the United States and other countries.

*2 Available to connect the host machine that supports USB 2.0. With the USB interface, not all hardware (such as host machine, USB devices, USB hub) combination will work and guaranteed.

2. Setup

This chapter describes the preparation for using this product, the procedure for starting up the emulator and how to change settings.

2.1 Flowchart of Starting Up the Emulator

The procedure for starting up the emulator is shown in Figure 2.1. For details, refer to each section hereafter. And, when the emulator does not start up normally, refer to “5. Troubleshooting” (page 82).

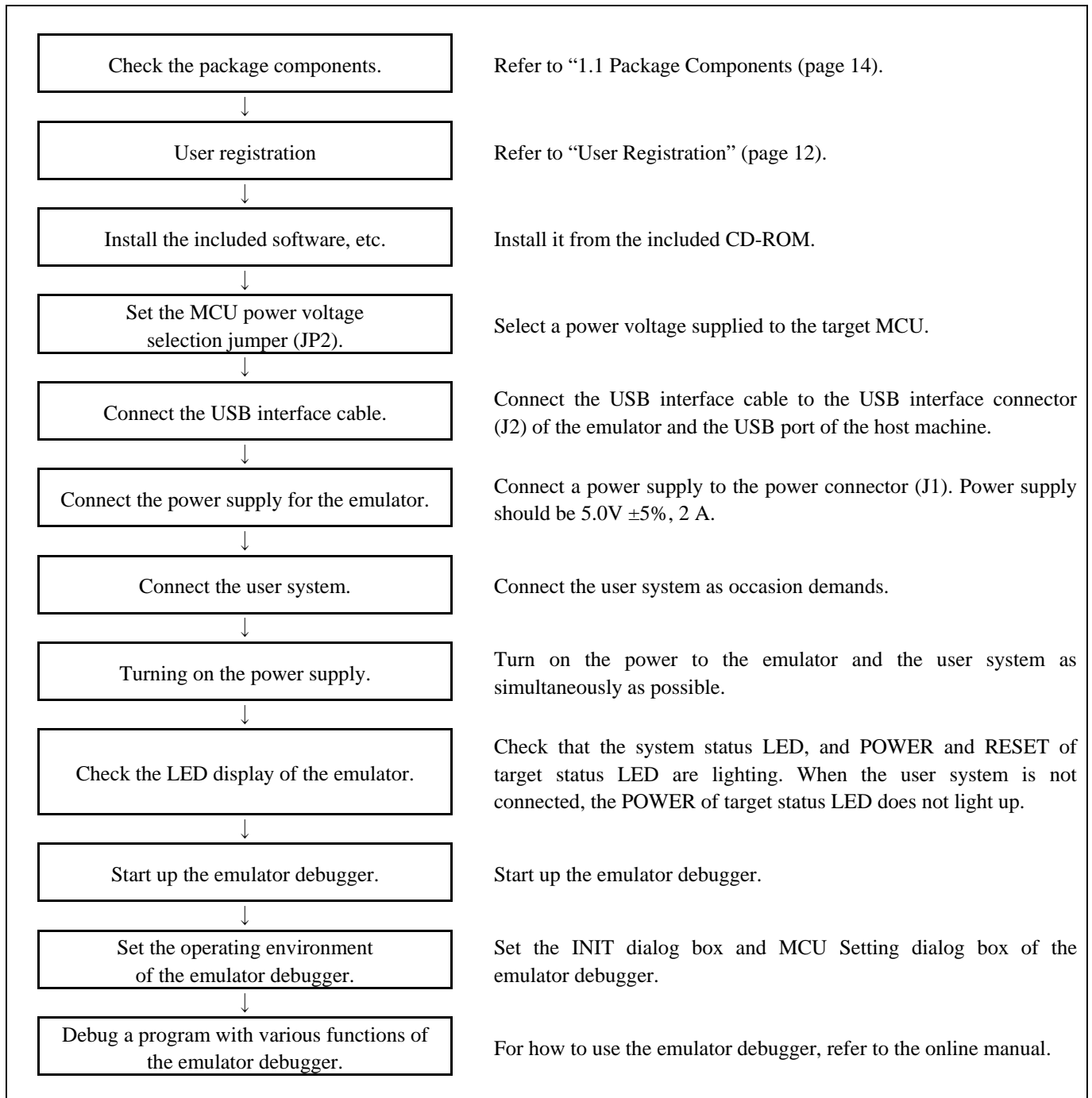

Figure 2.1 Flowchart of starting up the emulator

2.2 Installing the Included Software

If the OS used in your host machine is Windows XP or 2000, this installation must be executed by a user with administrator rights. Be aware that users without administrator rights cannot complete the installation.

Install the software as instructed by the displayed messages by inserting the included CD into the CD-ROM drive.

In process of installation, "user information" dialog box to enter the user information (contractor, section, contact address, and host machine) will open. The supplied information will be turned into a format by user registration will be provided by e-mail.

2.3 Attaching the Ferrite Core

Attach the ferrite core included with this product close to the DC plug of the power cable. Without the ferrite core it may cause interference.

The power cable should be wound around the ferrite core as shown in the figure, and close the ferrite core until it clicks.

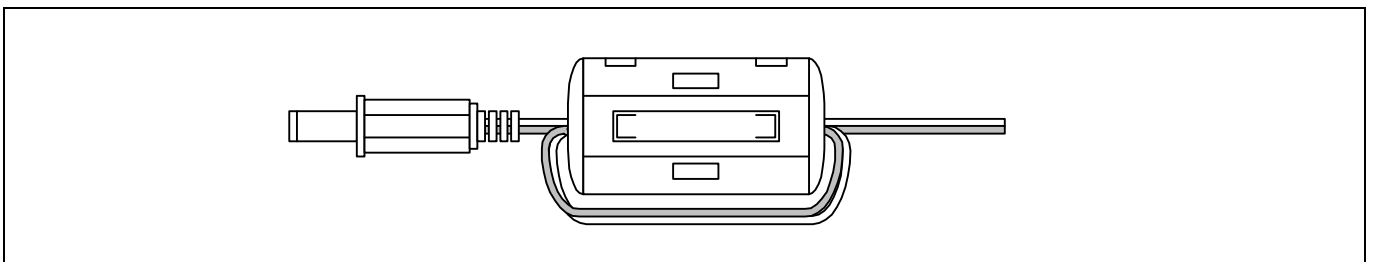

Figure 2.2 Attaching the ferrite core

2.4 Connecting the Power Supply for the Emulator

Connect the power supply for the emulator to the power connector (J1). The specification of the power supply for the emulator is listed in Table 2.1.

Table 2.1 Specification of power supply of the emulator

Power supply voltage	DC 5.0V \pm 5%/2A
----------------------	---------------------

Figures 2.3 and 2.4 show the specifications of the power connector (J1) and an applicable plug, respectively.

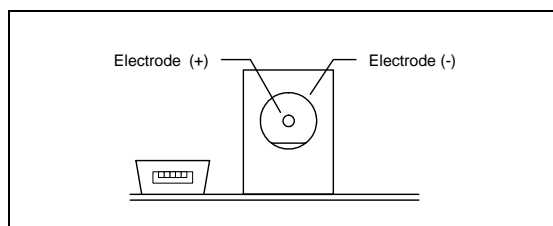

Figure 2.3 Power connector specifications

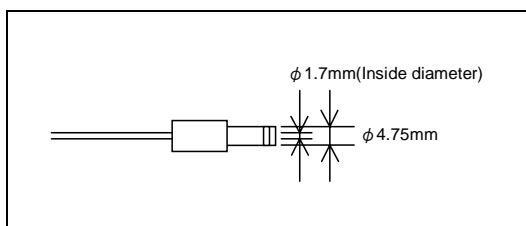

Figure 2.4 Applicable plug specifications

CAUTION

Notes on Connecting a Power Supply of the Emulator:



- The power cable included in this product package is colored red (+) and black (-).
- Be careful about the polarity of the power supply. Connecting to the wrong electrode could destroy internal circuits.
- Do not apply a voltage exceeding the specified voltage of the product (5.0V \pm 5%), because it may cause burn injuries and the failure of internal circuits.
- Use the power supply which complies with CE marking requirements.

2.5 Connecting the Host Machine

Connect the emulator and the host machine with the USB interface cable.

Connect the USB interface cable (included) to the USB interface connector (J2) and the USB port of the host machine (see Figure 2.5).

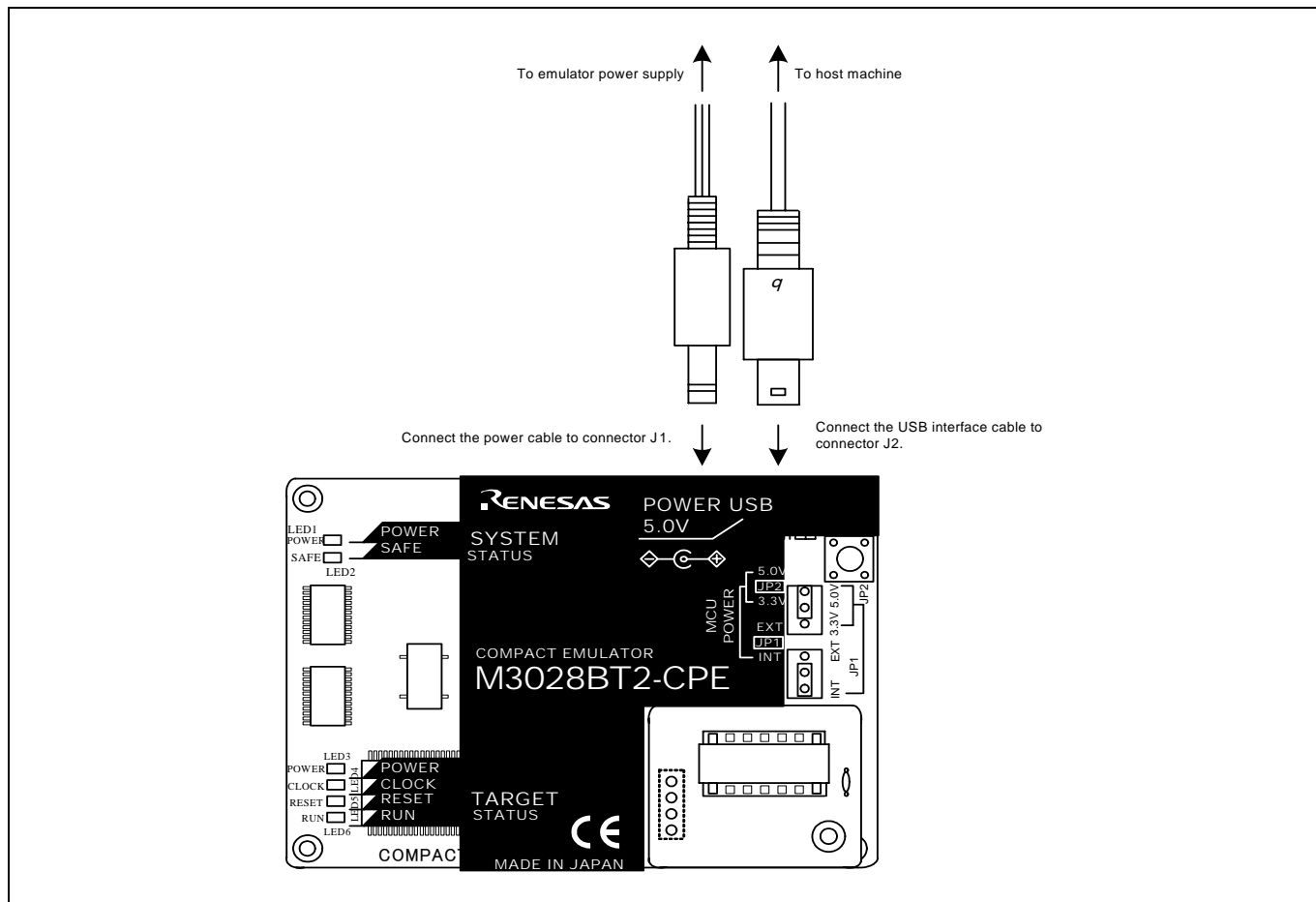

Figure 2.5 Connecting the emulator system

2.6 Turning ON the Power

2.6.1 MCU Power Supply Source Selection Jumper/MCU Power Supply Voltage Selection Jumper

Set the MCU power supply source selection jumper and the MCU power supply voltage selection jumper of the emulator according to conditions of use.

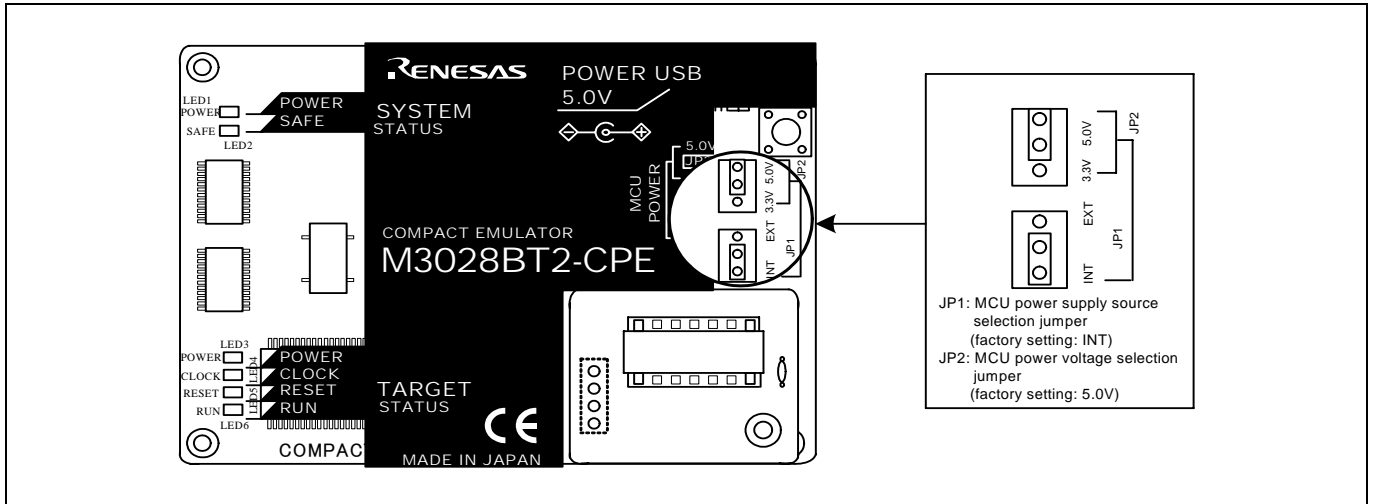

Figure 2.6 Jumper switch locations

These are the jumper switches to select power supply to the MCU and its power voltage. As shown in Table 2.2 below, set the switch according to the connection to the user system.

Table 2.2 Setting jumper switches

Connection to the user system	MCU power supply source selection jumper (JP1)	MCU power supply voltage selection jumper (JP2)	Description
Not connected	INT	3.3V	Supplied from the emulator. The MCU operating voltage is 3.3V.
		5.0V	Supplied from the emulator. The MCU operating voltage is 5.0V.
Connected	EXT	Invalid	Supplied from the user system. This emulator consumes max. 500mA of electrical current from the user system.

⚠ CAUTION

Note on Jumper Switch Settings:



- Always shut OFF the emulator before changing the setting of the jumper switches, and connecting the cable. Otherwise the internal circuit may cause a break.

2.6.2 Checking Connections of the Emulator System

Before turning the power ON, check the connection of the interface cable to the host machine, emulator, and user system.

2.6.3 Power Supply to the User System

This emulator cannot supply the power to the user system. Therefore design your system so that the user system is powered separately. This product consumes max. 500mA of electrical current from the user system. Please consider the capacity of the power supply of the user system.

The voltage of the user system should be $2.7V \leq VCC \leq 5.5V$. Do not change the voltage of the user system after turning on the power.

2.6.4 Turning ON/OFF the Power

Turn ON/OFF the power of the emulator and user system as simultaneously as possible.

Do not leave either the emulator or user system powered on, because of leakage current the internal circuits may be damaged.

When turning ON the power again after shutting OFF the power, wait for about 10 seconds.

2.6.5 LED Display When the Emulator Starts Up Normally

After the emulator starts up, check the status of the LEDs to see whether the emulator operation is enabled or not. Figure 2.7 shows the positions of the emulator status LEDs.

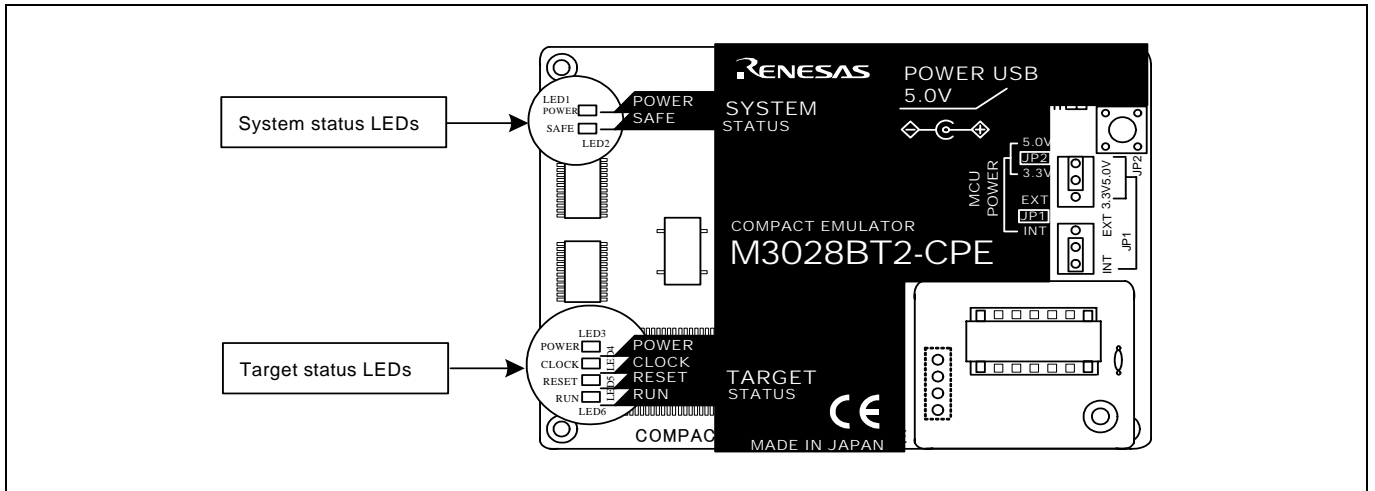

Figure 2.7 Positions of the system status LEDs and target status LEDs

(1) System status LEDs

Check that the LED1 and LED2 of the system status LEDs are lit immediately after the power is activated. If it is not lit, shut off the emulator and check the power supply for the emulator is properly connected.

(2) Target status LEDs

Target status LEDs light as shown in Figure 2.8 when the user system is not connected and as shown in Figure 2.9 when a user system is connected.

When the target status LEDs do not display as shown in Figures 2.8 and 2.9, refer to “5. Troubleshooting” (page 82).

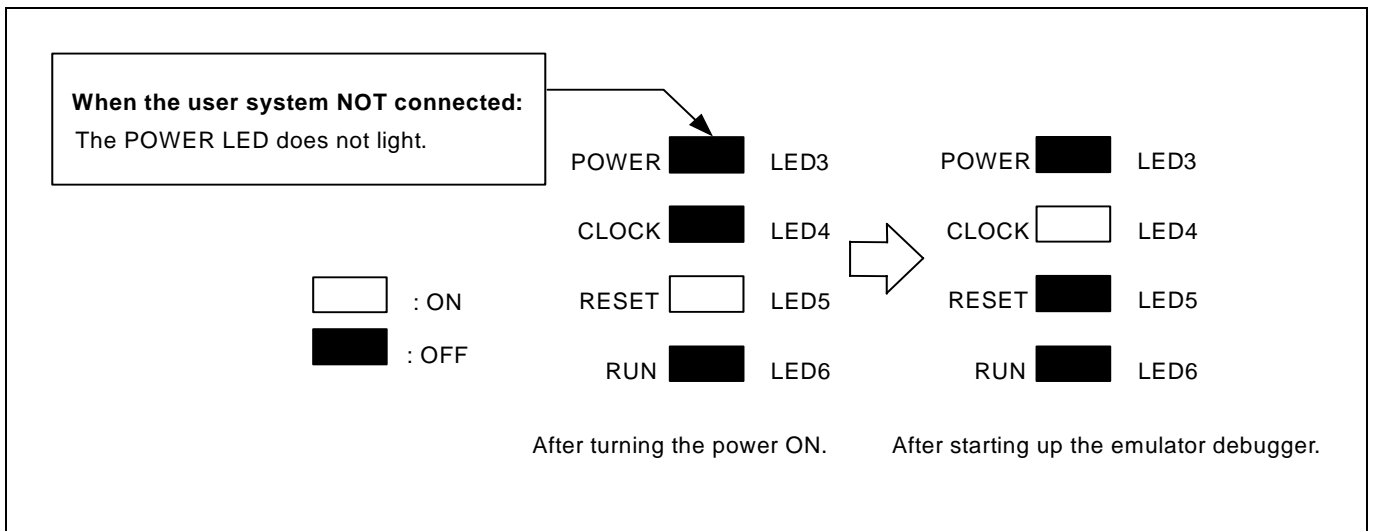

Figure 2.8 Target status LEDs display when the emulator starts up normally (when user system not connected)

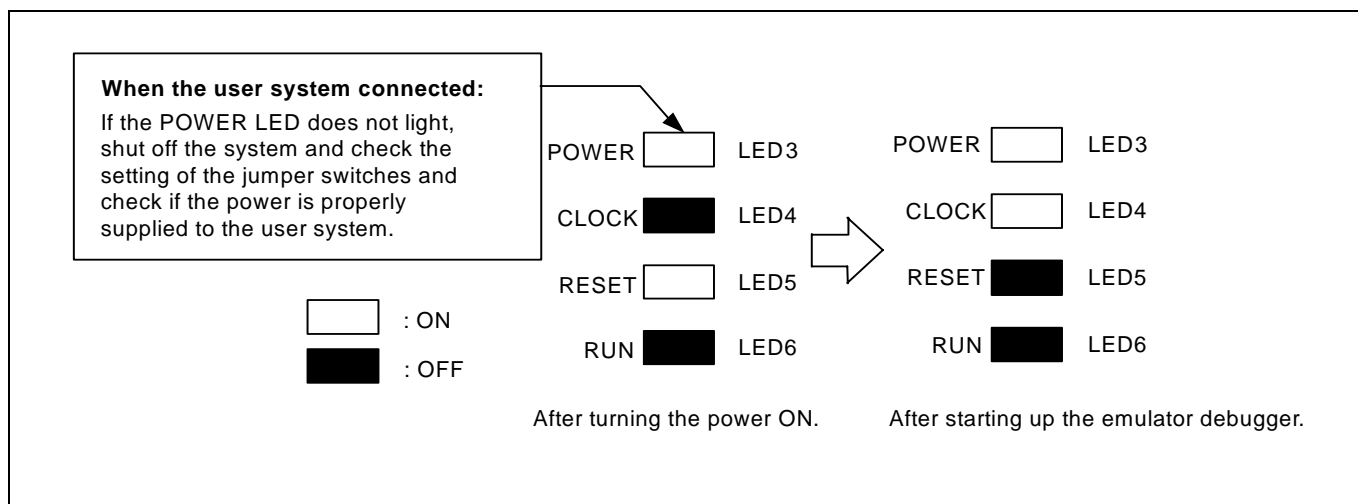

Figure 2.9 Target status LEDs display when the emulator starts up normally (when user system connected)

IMPORTANT

Note on the Target Status CLOCK LED:

- If the LED is not turned on, check the following.
 - After the emulator debugger is started up (after the Init dialog box settings are completed):
 Make sure that the oscillator selected in the Init dialog box is oscillating normally.

2.7 Self-check

2.7.1 Self-check Procedure

The self-check is a function to check the memory etc. mounted in the emulator. To run the self-check of the emulator, do so as explained here below. While the self-check is in progress, the LEDs will change as shown in Figure 2.10.

- (1) If the user system is connected, disconnect it.
- (2) Set the switches as the factory-settings to execute the self-check (see Table 2.3).
- (3) Within 2 seconds of activating power to the emulator, press the system reset switch on the emulator upper panel.
- (4) Check the SAFE LED starts flashing and then press the system reset switch again.
- (5) The self-check will start. If the normal result is displayed in about 10 seconds, the self-check terminated normally.

Table 2.3 Switch settings for the self-check

Switch	Setting
MCU power supply source selection jumper (JP1)	INT
MCU power supply voltage selection jumper (JP2)	5V

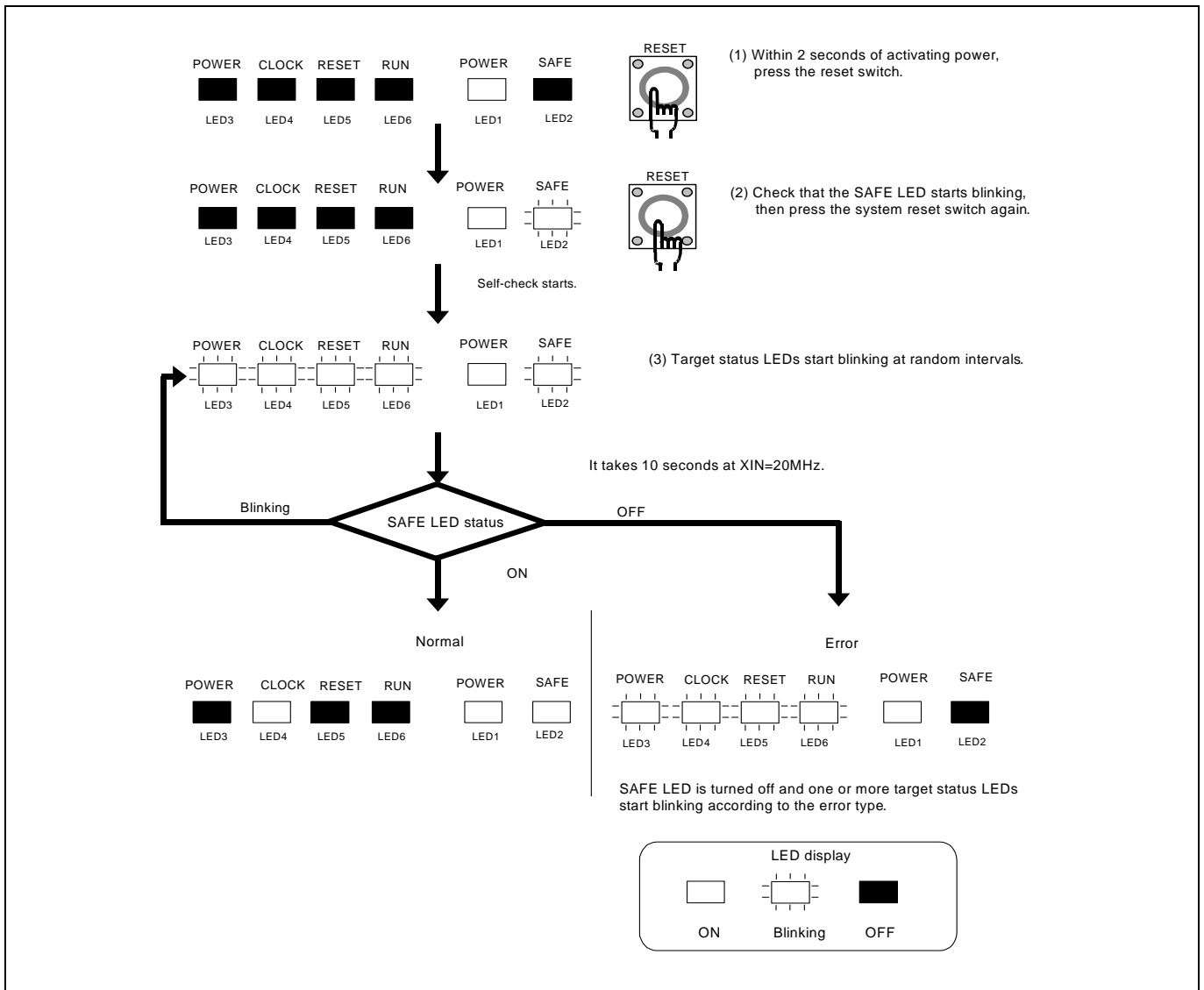





























































Figure 2.10 Self-check procedure

2.7.2 If an Error is Detected in the Self-check

Table 2.4 lists how to remedy the troubles if the target status LED display is abnormal in the self-check. When an error is detected, shut off the emulator and the user system and follow the steps in the Table 2.4.

Table 2.4 Error LED display in the self-check and how to remedy it

LED display				Problem & Remedy
POWER	CLOCK	RESET	RUN	
				The emulator system is not working properly. - Check that power is supplied to the emulator. - The emulator may be damaged. Contact your local distributor.
				
				A clock is not supplied to the emulator. - Check that the oscillator circuit board (OSC-3) is attached.
				The power is not supplied to the MCU. - Check that the power supply cable is connected properly. - Check of jumper switch settings (see Table 2.3).
				The block 0 area (address FF000h--FFFFFFh) may be rewritten when debugging in the CPU rewrite mode. - Within 2 seconds of activating power to the emulator, press the system reset switch to restart the emulator debugger. The firmware will be redownloaded.
				The emulator system is not working properly. - The emulator may be damaged. Contact your local distributor.
				
				
				
				
				
				
				
				
				

IMPORTANT

Notes on the Self-check:

- **Be sure to disconnect the user system** before executing the self-check.
Use the preinstalled oscillator circuit board OSC-3 (20MHz) to execute the self-check.
- If the self-check does not result normally (excluding target status errors), the emulator may be damaged. Then, contact your local distributor.

2.8 Connecting the User System

Figure 2.11 shows the connection of the M3028BT2-CPE and the user system.

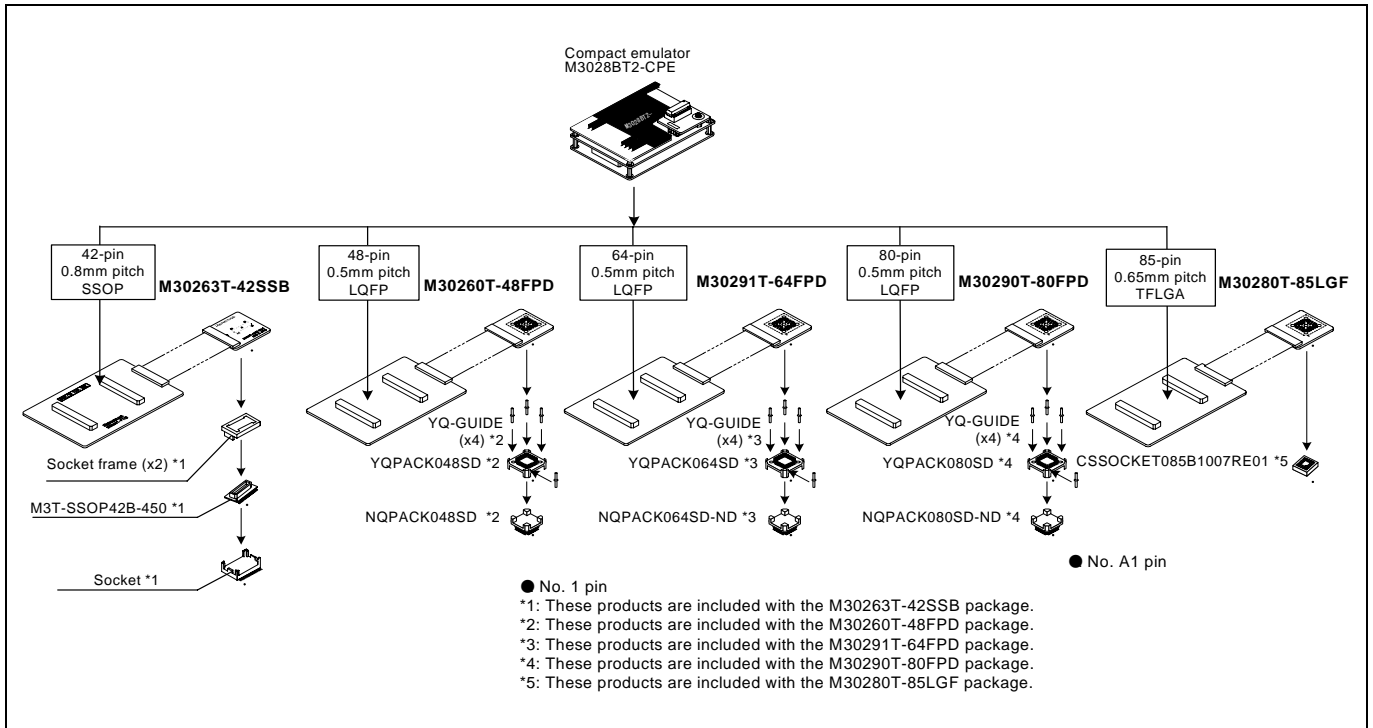

Figure 2.11 Connection of the M3028BT2-CPE and user system

CAUTION

Note on Connecting the User System:



- Take care not to attach the converter board in a wrong direction. It may cause a fatal damage to the emulator and user system.

* NQPACK, YQPACK, YQSOCKET, YQ-GUIDE, HQPACK, TQPACK, TQSOCKET, CSSOCKET and CSPLUG/W are trademarks of Tokyo Eletech Corporation.

2.8.1 Connecting to a 42-pin 0.8mm pitch Foot Pattern

Here following is a procedure of connecting to a 42-pin 0.8mm pitch foot pattern on the user system using the M30263T-42SSB (included with the M3028BT2-CPE-1). For details on the M30263T-42SSB, refer to its user's manual.

- (1) Mount the socket included with the M30263T-42SSB to the user system.
- (2) Attach the M3T-SSOP42B-450 included with the M30263T-42SSB and the socket frame to the socket.
- (3) Attach the J1 and J2 of the M30290T-PTCB to the J3 and J4 of the M3028BT2-CPE.
- (4) Attach the M30263T-42SSB to the M3T-SSOP42B-450.

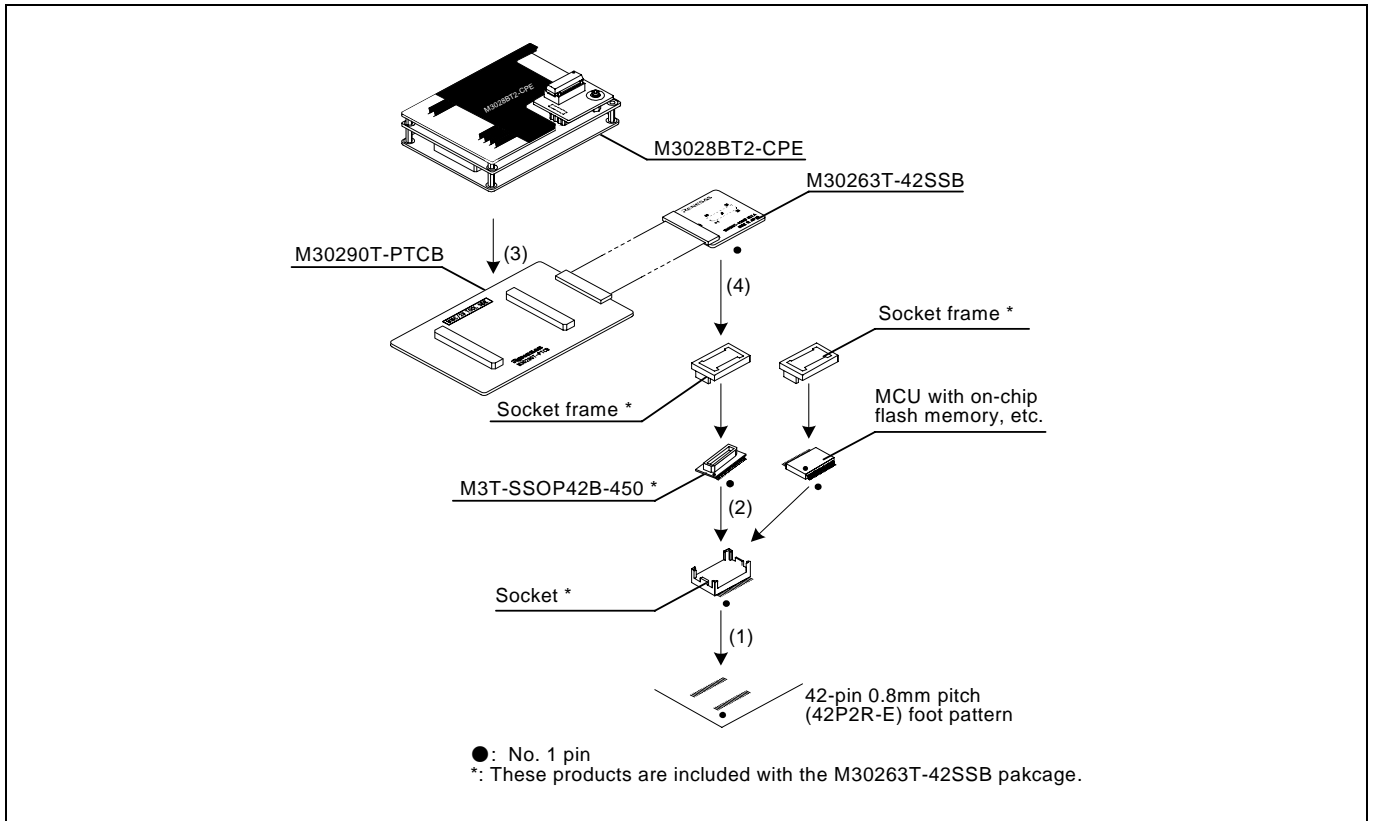

Figure 2.12 Connecting to a 42-pin 0.8mm pitch foot pattern

CAUTION

Notes on Connecting the User System:



- Take care not to attach a converter board in a wrong direction. It may cause a fatal damage to the emulator and user system.

IMPORTANT

Note on Connectors of the Converter board:

- The connectors of the M3028BT2-CPE and M30290T-PTCB are guaranteed for only 50 insertion/removal iterations.

2.8.2 Connecting to a 48-pin 0.5mm pitch Foot Pattern

Here following is a procedure of connecting to a 48-pin 0.5mm pitch foot pattern on the user system using the M30260T-48FPD (included with the M3028BT2-CPE-2). For details on the M30260T-48FPD, refer to its user's manual.

- (1) Mount the NQPACK048SD included with the M30260T-48FPD to the user system.
- (2) Attach the YQPACK048SD included with the M30260T-48FPD to the NQPACK048SD and secure it with the YQ-GUIDE's.
- (3) Attach the J1 and J2 of the M30290T-PTCB to the J3 and J4 of the M3028BT2-CPE.
- (4) Attach the M30260T-48FPD to the YQPACK048SD.

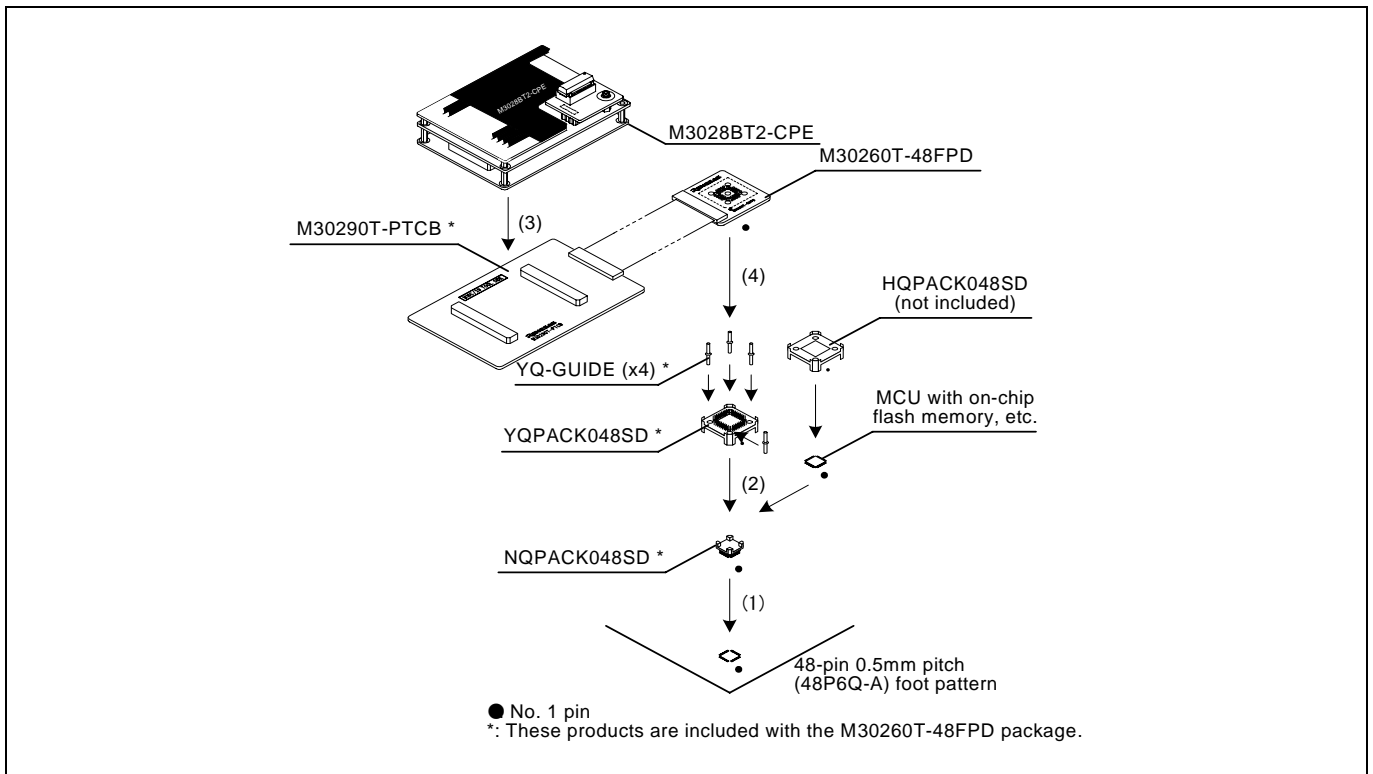

Figure 2.13 Connecting to a 48-pin 0.5mm pitch foot pattern

CAUTION

Notes on Connecting the User System:



- Take care not to attach a converter board in a wrong direction. It may cause a fatal damage to the emulator and user system.

IMPORTANT

Notes on Connectors of the Converter board:

- The connectors of the M3028BT2-CPE and M30290T-PTCB are guaranteed for only 50 insertion/removal iterations.
- Between the M30260T-48FPD and YQPACK048SD are guaranteed for only 100 insertion/removal iterations.

2.8.3 Connecting to a 64-pin 0.5mm pitch Foot Pattern

Here following is a procedure of connecting to a 64-pin 0.5mm pitch foot pattern on the user system using the M30291T-64FPD (included with the M3028BT2-CPE-3). For details on the M30291T-64FPD, refer to its user's manual.

- (1) Mount the NQPACK064SD-ND included with the M30291T-64FPD to the user system.
- (2) Attach the YQPACK064SD included with the M30291T-64FPD to the NQPACK064SD-ND and secure it with the YQ-GUIDE's.
- (3) Attach the J1 and J2 of the M30290T-PTCB to the J3 and J4 of the M3028BT2-CPE.
- (4) Attach the M30291T-64FPD to the YQPACK064SD.

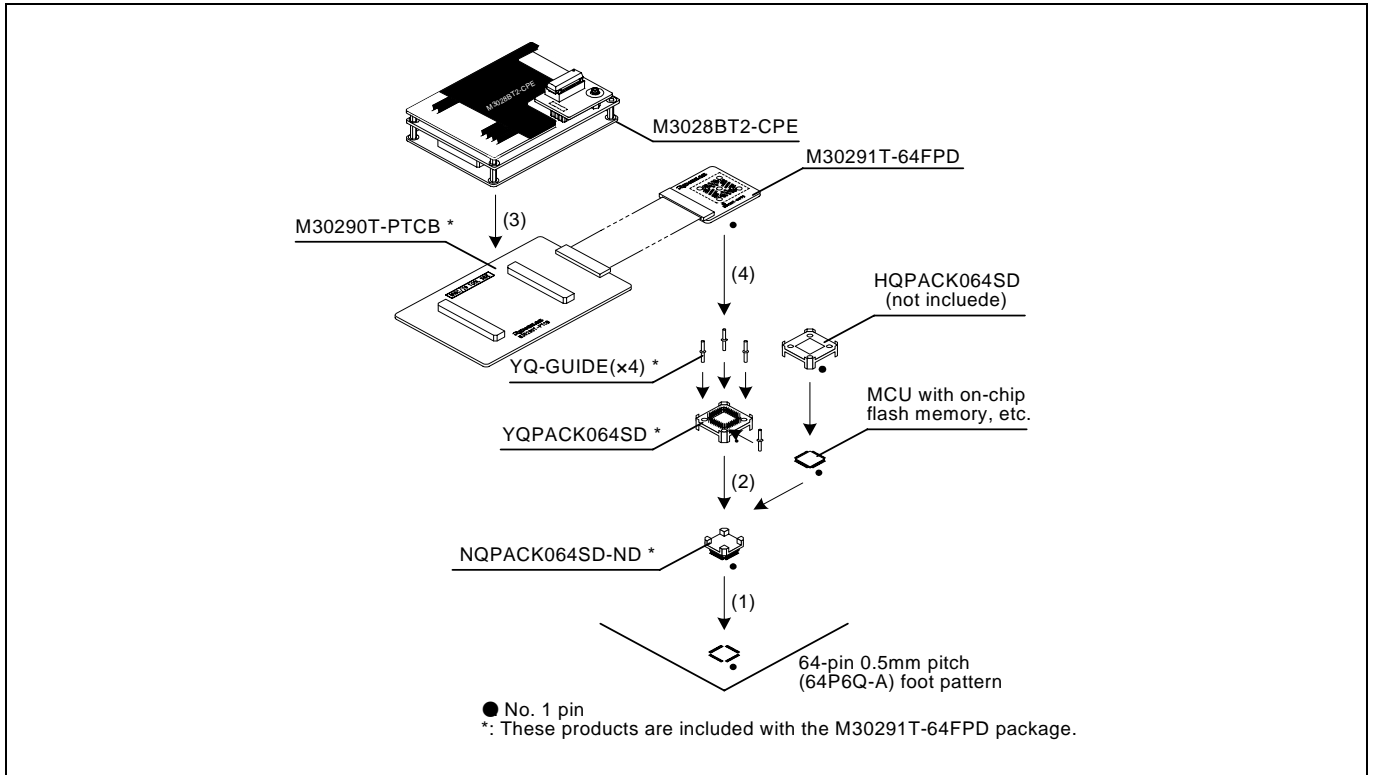

Figure 2.14 Connecting to a 64-pin 0.5mm pitch foot pattern

CAUTION

Notes on Connecting the User System:



- Take care not to attach a converter board in a wrong direction. It may cause a fatal damage to the emulator and user system.

IMPORTANT

Notes on Connectors of the Converter board:

- The connectors of the M3028BT2-CPE and M30290T-PTCB are guaranteed for only 50 insertion/removal iterations.
- Between the M30291T-64FPD and YQPACK064SD are guaranteed for only 100 insertion/removal iterations.

2.8.4 Connecting to an 80-pin 0.5mm pitch Foot Pattern

Here following is a procedure of connecting to an 80-pin 0.5mm pitch foot pattern on the user system using the M30290T-80FPD (included with the M3028BT2-CPE-4). For details on the M30290T-80FPD, refer to its user's manual.

- (1) Mount the NQPACK080SD-ND included with the M30290T-80FPD to the user system.
- (2) Attach the YQPACK080SD included with the M30290T-80FPD to the NQPACK080SD-ND and secure it with the YQ-GUIDE's.
- (3) Attach the J1 and J2 of the M30290T-PTCB to the J3 and J4 of the M3028BT2-CPE.
- (4) Attach the M30290T-80FPD to the YQPACK080SD.

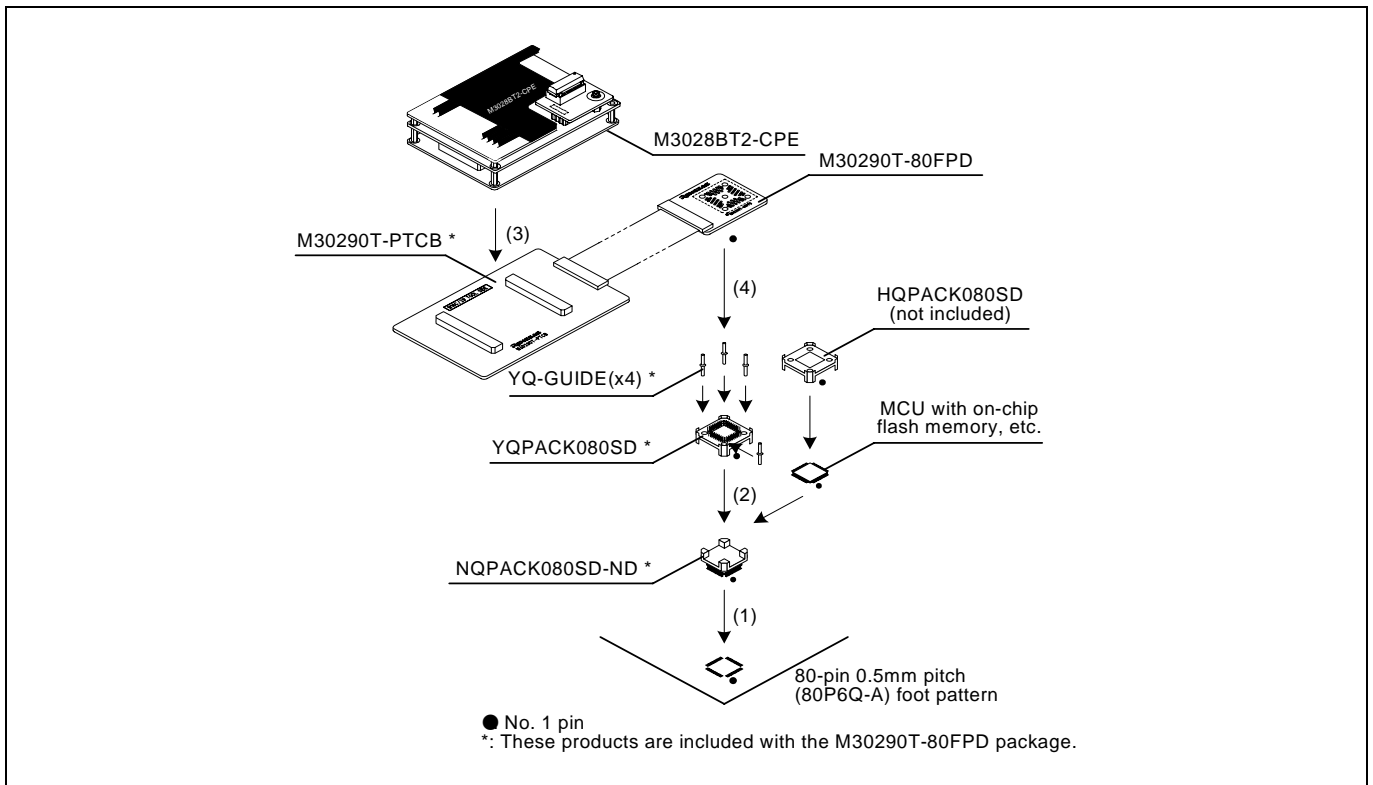

Figure 2.15 Connecting to an 80-pin 0.5mm pitch foot pattern

⚠ CAUTION

Notes on Connecting the User System:



- Take care not to attach a converter board in a wrong direction. It may cause a fatal damage to the emulator and user system.

IMPORTANT

Notes on Connectors of the Converter board:

- The connectors of the M3028BT2-CPE and M30290T-PTCB are guaranteed for only 50 insertion/removal iterations.
- Between the M30290T-80FPD and YQPACK080SD are guaranteed for only 100 insertion/removal iterations.

2.8.5 Connecting to an 85-pin 0.65mm pitch Foot Pattern

Here following is a procedure of connecting to an 85-pin 0.65mm pitch foot pattern on the user system using the M30280T-85LGF (included with the M3028BT2-CPE-5). For details on the M30280T-85LGF, refer to its user's manual.

- (1) Mount the CSSOCKET085B1007RE01 included with the M30280T-85LGF to the user system.
- (2) Attach the J1 and J2 of the M30290T-PTCB to the J3 and J4 of the M3028BT2-CPE.
- (3) Attach the M30280T-85LGF to the CSSOCKET085B1007RE01.

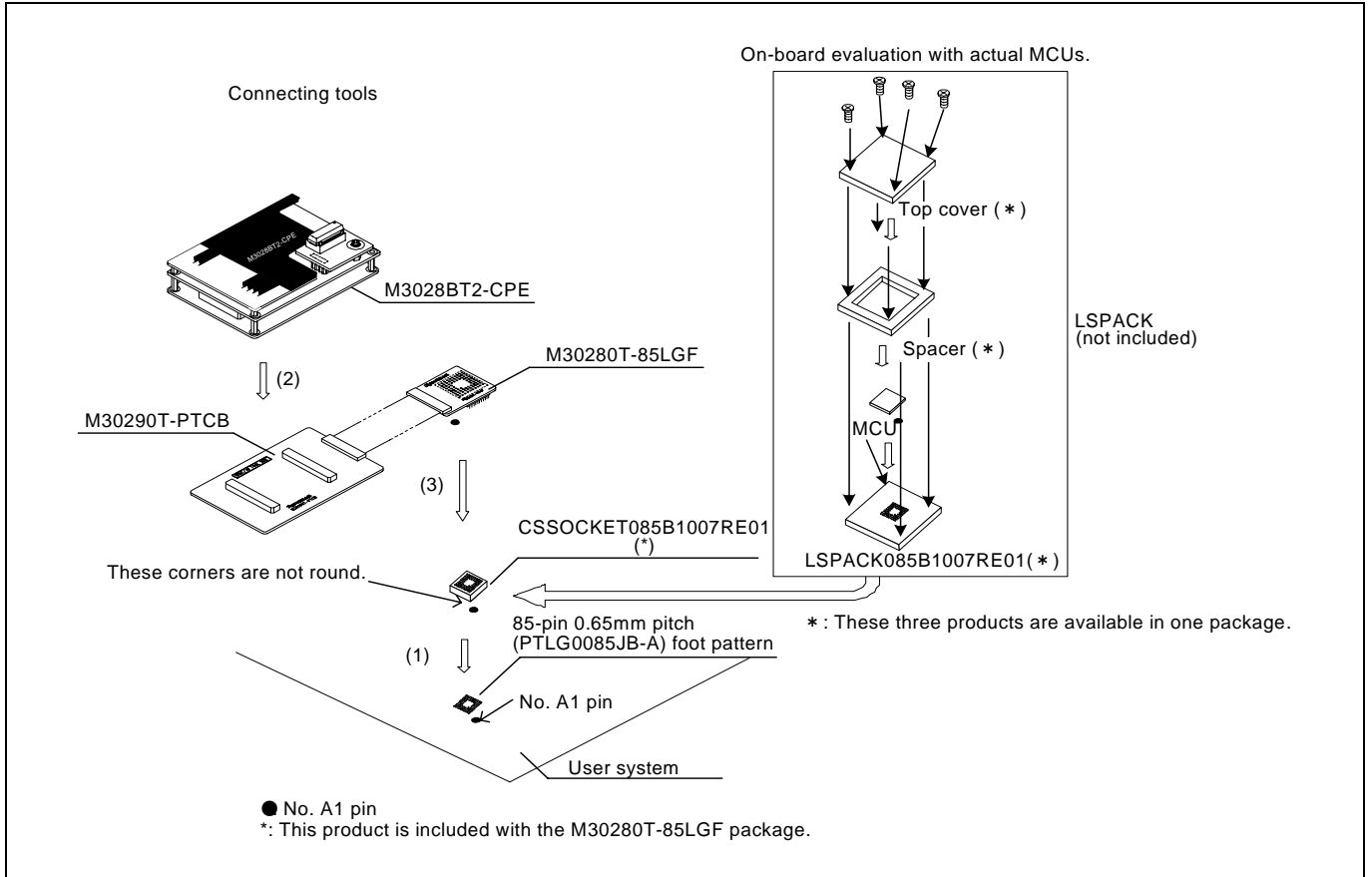

Figure 2.16 Connecting to an 85-pin 0.65mm pitch foot pattern

CAUTION

Notes on Connecting the User System:



- Take care not to attach a converter board in a wrong direction. It may cause a fatal damage to the emulator and user system.

IMPORTANT

Note on Connectors of the Converter board:

- The connectors of the M3028BT2-CPE and M30290T-PTCB are guaranteed for only 50 insertion/removal iterations.

2.9 Changing Settings

2.9.1 MCU Power Supply Source Selection Jumper/MCU Power Supply Voltage Selection Jumper

These are the jumper switches to select power supply to the MCU and its power voltage. As shown in Table 2.5 below, set the switch according to the connection to the user system.

Table 2.5 Setting jumper switches

Connection to the user system	MCU power supply source selection jumper (JP1)	MCU power supply voltage selection jumper (JP2)	Description
Not connected	INT	3.3 V	Supplied from the emulator. The MCU operating voltage is 3.3 V.
		5.0 V	Supplied from the emulator. The MCU operating voltage is 5.0 V.
Connected	EXT	Invalid	Supplied from the user system. This emulator consumes max. 500mA of electrical current from the user system.

CAUTION

Note on Setting Jumper Switches:



- Always shut OFF the emulator before changing the setting of the jumper switches, and connecting the cable. Otherwise the internal circuit may cause a break.

2.9.2 Selecting Clock Supply

You can choose a clock supplied to the evaluation MCU by the Emulator tab in the Init dialog box of the emulator debugger. Table 2.6 shows the clocks and their initial settings.

Table 2.6 Clock supply to the MCU

Clock	Emulator debugger display	Description	Initial setting
Main (X_{IN} - X_{OUT})	Internal	Internal oscillator circuit board (OSC-3 or OSC-2)	Yes
	External	Oscillator circuit on the user system	-
Sub (X_{CIN} - X_{COUT})	Internal	Internal oscillator circuit (32.768kHz)	-
	External	Oscillator circuit on the user system	Yes

(1) Using an Internal Oscillator Circuit Board

1. Kinds of Oscillator Boards

The M3028BT2-CPE comes with an oscillator circuit board OSC-3 (20MHz). And an oscillator circuit bare board OSC-2 is included with this product. If you use an internal oscillator circuit board of the emulator as a main clock, choose "Internal" in the emulator debugger after replacing oscillator circuit boards to change a clock supplied to an MCU.

2. Replacing Oscillator Circuit Boards

Figure 2.17 shows how to replace the oscillator circuit boards.

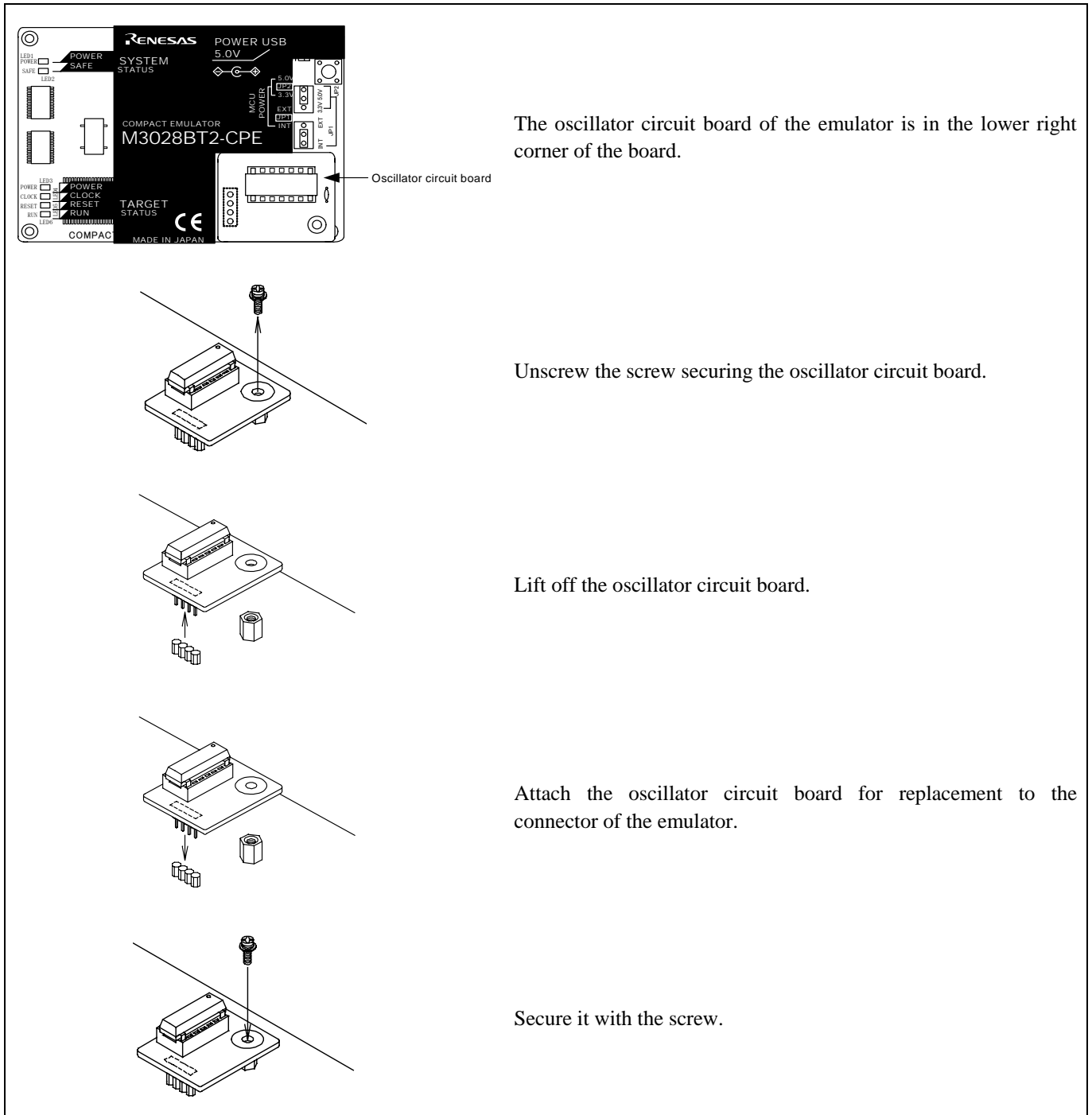

Figure 2.17 Replacing oscillator circuit boards

CAUTION

Note on Replacing the Oscillator Circuit Board:



- When replacing the oscillator circuit boards, be sure to shut OFF the power supply. Otherwise the internal circuit may cause a break.

3. Using the Internal Oscillator Circuit Bare Board

To use this product at a frequency you like, build a desired oscillator circuit on the included OSC-2 oscillator circuit bare board. Figure 2.18 shows an external view of the OSC-2 oscillator circuit bare board and the connector pin locations. Figure 2.19 shows the circuitry of the oscillator circuit bare board OSC-2. Use the number of oscillator circuits recommended by the oscillator manufacturer.

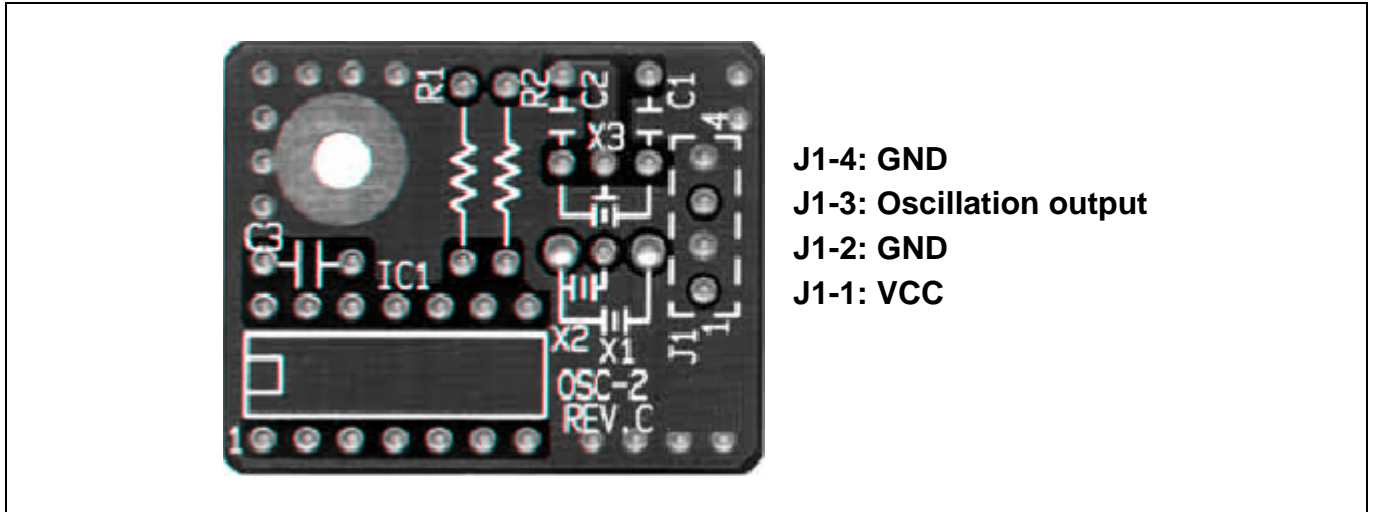

Figure 2.18 External view of the oscillator circuit board OSC-2 and its connector pin locations

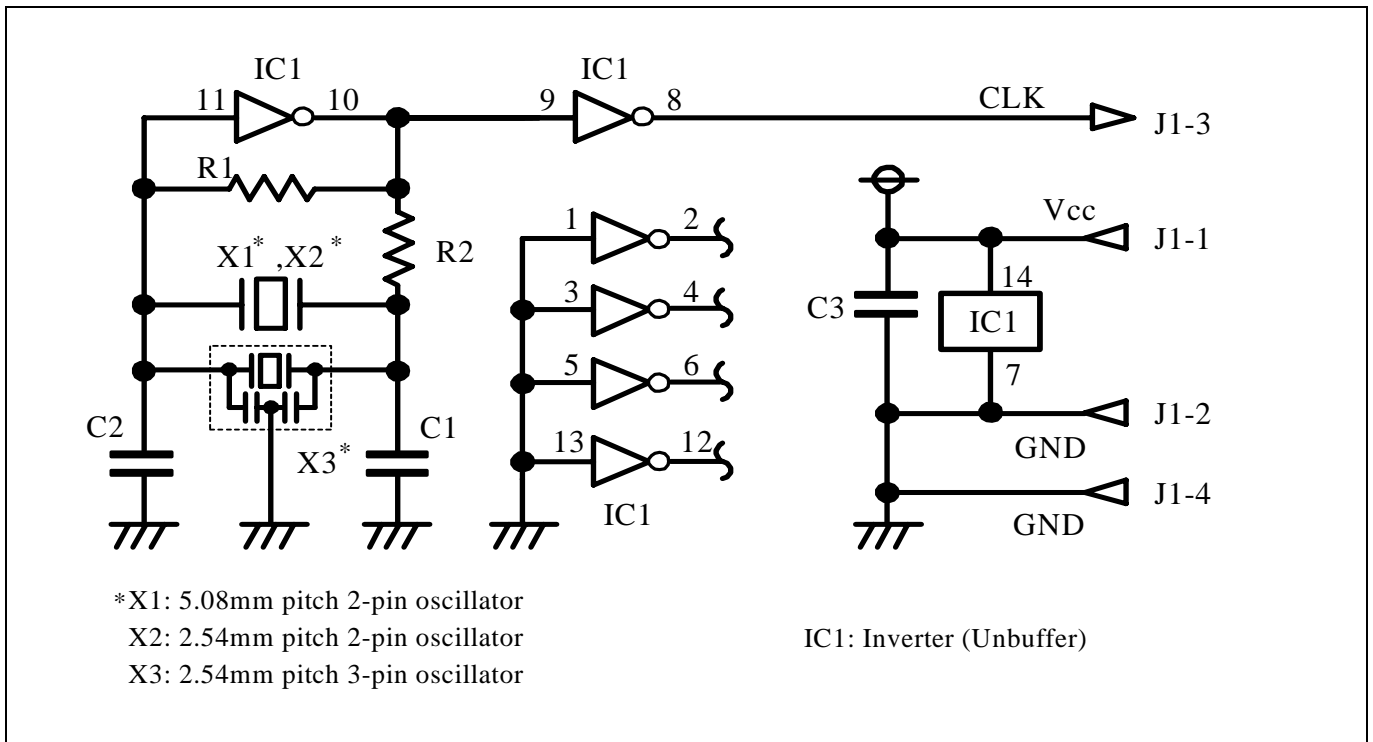

Figure 2.19 Circuits of the oscillator circuit bare board OSC-2

(2) Using an Oscillator Circuit on the User System

To operate this product with an external clock, construct an oscillator circuit as shown in Figure 2.20 in the user system and input the oscillator output at 50% duty (within the operating range of the evaluation MCU) into pin X_{IN} . And pin X_{OUT} should be open. Choose "External" in the emulator debugger to use this clock.

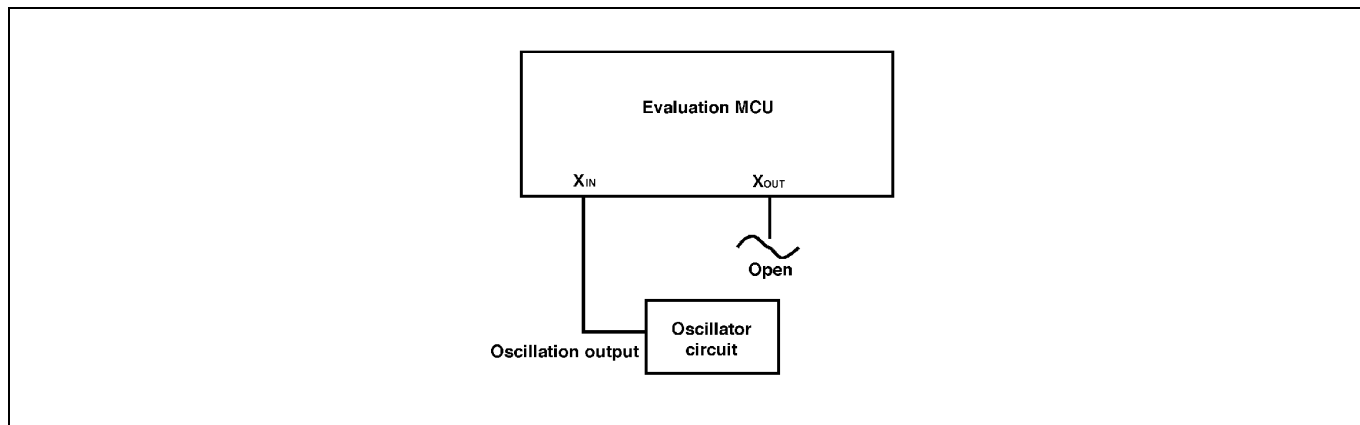

Figure 2.20 External oscillator circuit

Make note that in the oscillator circuit shown in Figure 2.21 where a resonator is connected between pins X_{IN} and X_{OUT} , oscillation does not occur because a converter board and other devices are used between the evaluation MCU and the user system. It is same for sub-clock oscillator circuits (X_{CIN} and X_{COUT}).

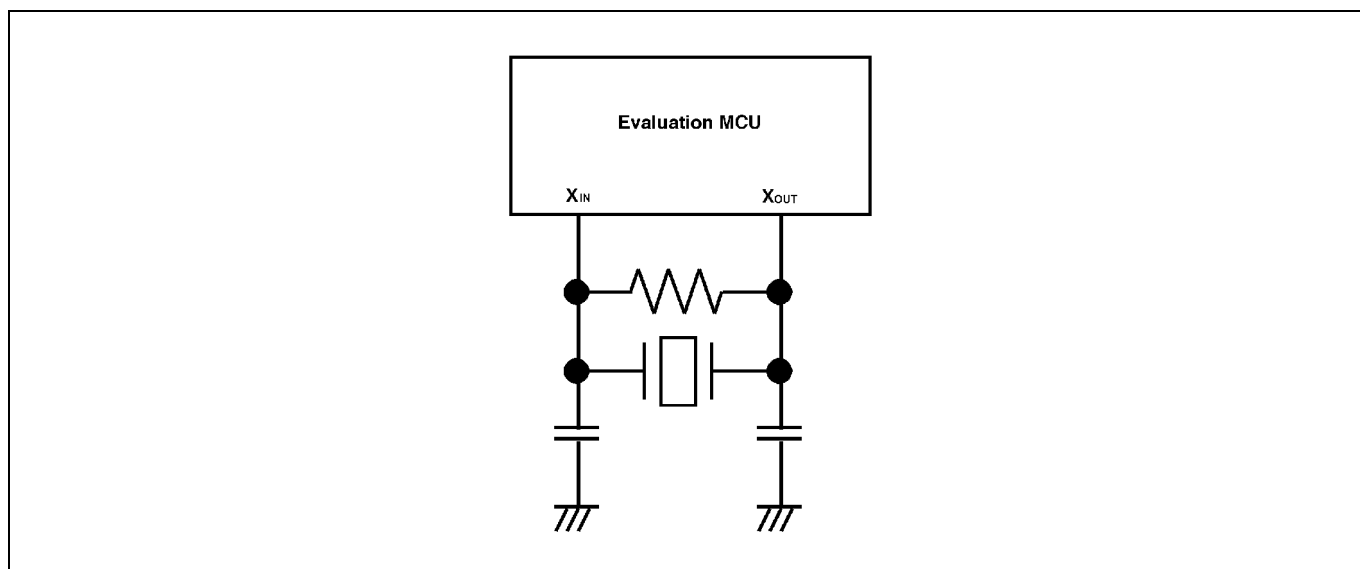

Figure 2.21 Circuit in which oscillation does not occur

2.9.3 A/D Conversion Bypass Capacitors

There is a foot pattern on the M3028BT-EPBM board for mounting bypass capacitors for an A/D conversion circuit near the MCU. Mount suitable bypass capacitors as occasion demands. Figure 2.22 shows where they are installed and the configuration of this product.

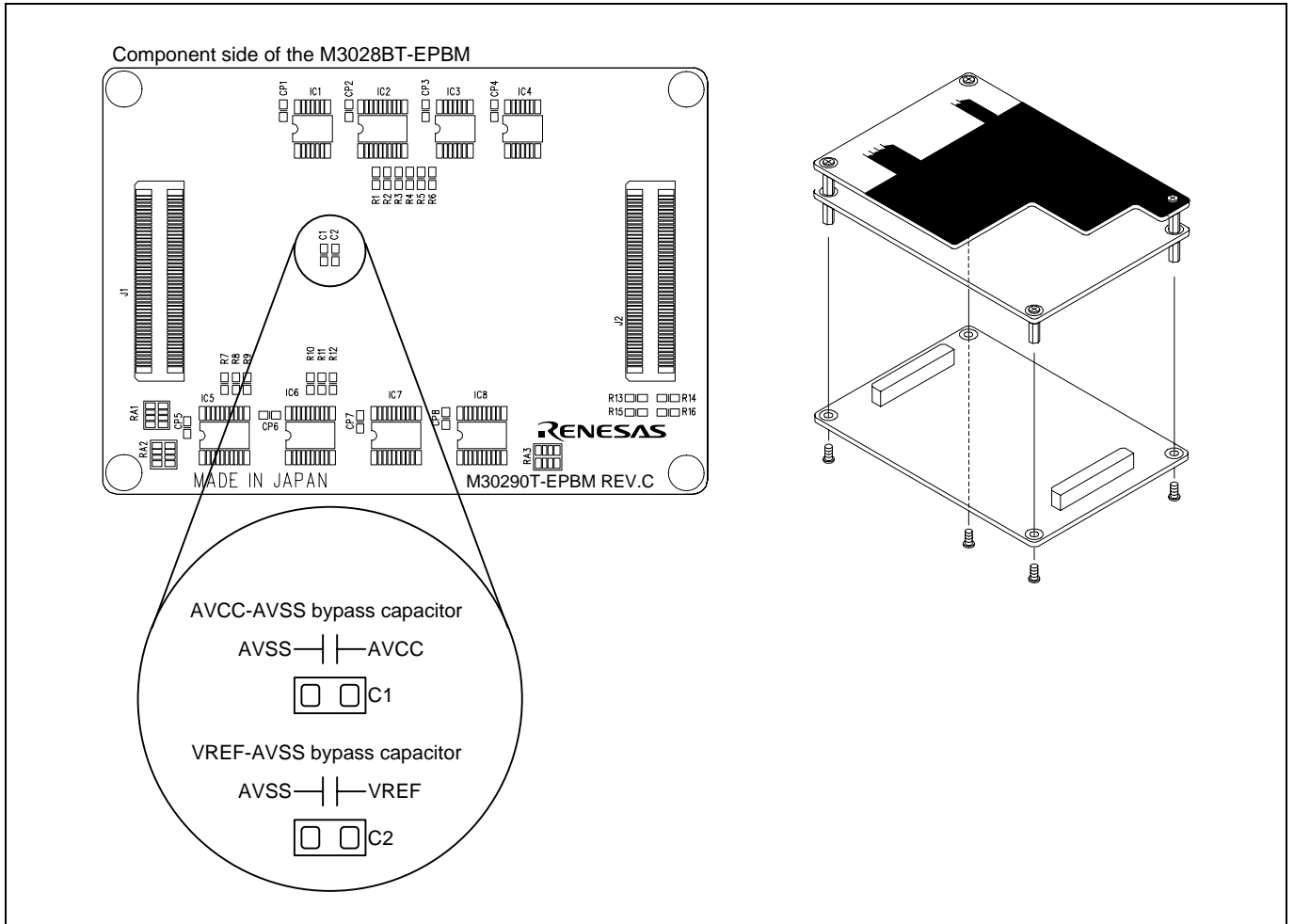

Figure 2.22 Foot pattern for A/D conversion bypass capacitors and the configuration of this product

IMPORTANT

Note on the A/D Converter Function:

- Because a package converter board and other devices are used between the evaluation MCU and the user system, the A/D converter operates differently from that of an actual MCU. Make the final evaluation of the A/D converter with an actual MCU.

3. Usage (How to Use the Emulator Debugger)

This chapter describes how to start up the emulator debugger and how to use the major windows.

3.1 Starting Up the Emulator Debugger

When debugging the completed programs, switch the session. The session can be changed by the drop down list of the tool bar shown below.



You will have as many sessions created as the number of targets you selected when creating a project, so select the session that corresponds to the target to be connected from the drop-down list. To connect to the M16C/Tiny Compact Emulator, select "SessionM16C_R8C_Compact_Emulator"

3.2 Init Dialog Box

The Init dialog box is used to set the items that need to be set when the emulator debugger starts up. The contents set in this dialog box remain effective the next time you start the debugger.

(1) MCU tab

1. Specifying the MCU file

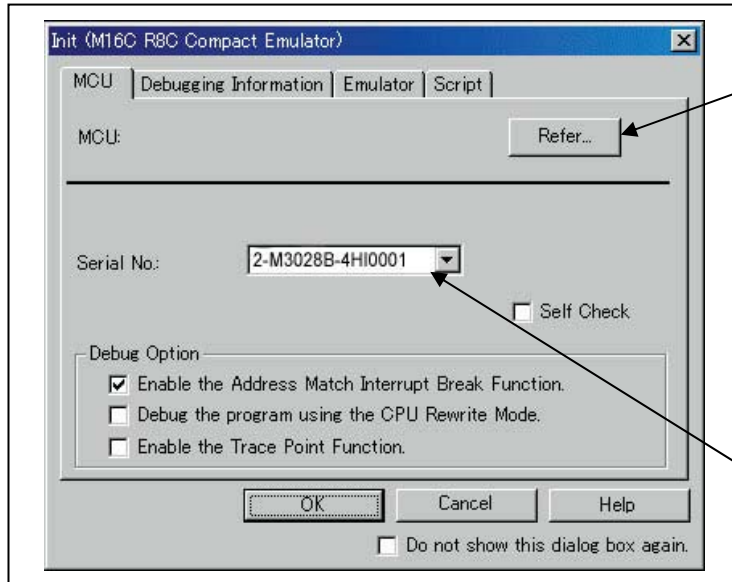

Specifying the MCU file

Click the "Refer..." button.

A file selection dialog box will be displayed, so select the MCU file corresponding to the target MCU.

- The MCU file contains the information specific to the target MCU.
- The MCU file you have selected is displayed in the MCU section of the MCU tab.

Serial No.

Shows the currently connected emulators in list form. Select the serial No. of the emulator you want to be connected.

2. Using or not using the address match break function

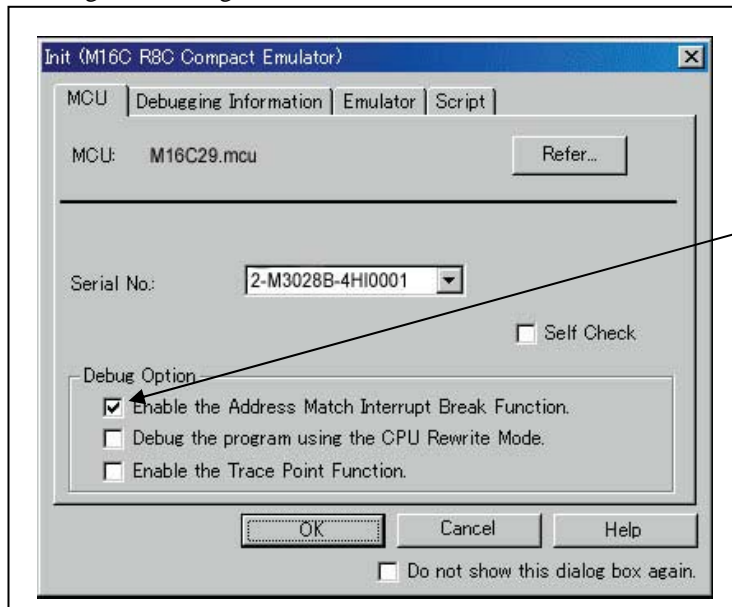

Using or not using the address match break function

Specify whether or not to use the address match break function.

- To use the address match break function (default), select the check box. In this case, the address match interrupt is used by the emulator, and cannot be used in the user program.
- When not using the address match break function, deselect the check box (check mark cleared). In this case, the address match interrupt can be used in the user program.

This option can be selected or deselected only when you are starting up the emulator debugger.

3. Using or not using the CPU rewrite mode

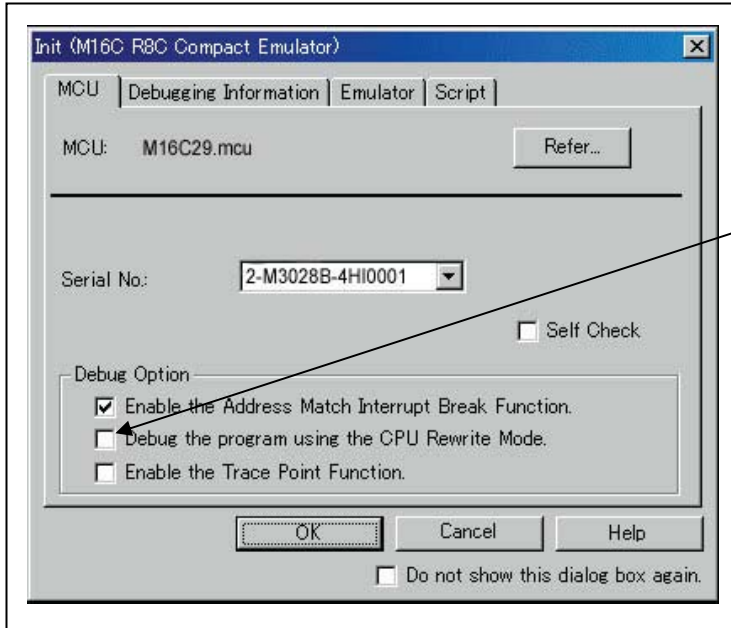

Using or not using CPU rewrite mode

Specify whether or not to debug in CPU rewrite mode. To debug the user system that uses CPU rewrite mode, check this box. This option can be selected or deselected only when you are starting up the emulator debugger.

Notes:

When debugging in CPU rewrite mode is enabled, the following functions cannot be used:

- Software breakpoint setting in the internal ROM area
- Execution of COME in the internal ROM area

4. Using or not using the trace point function

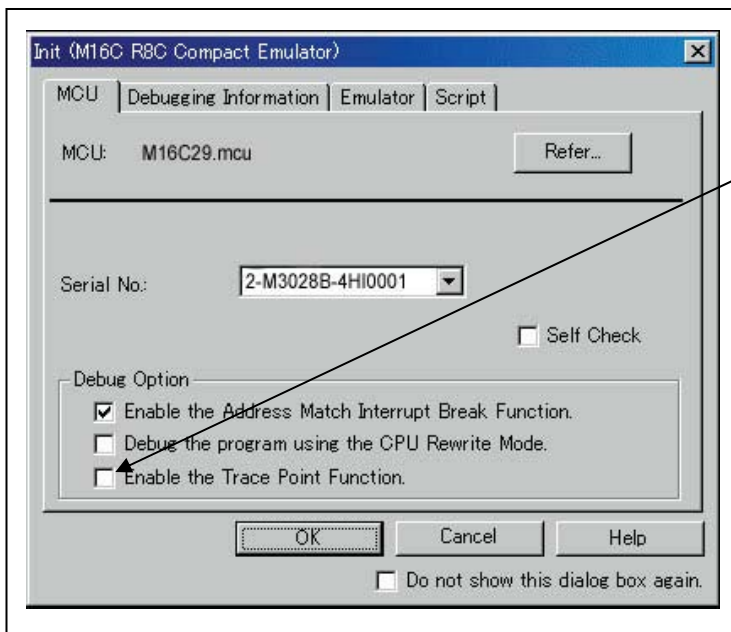

Using or not using the trace point function

The emulator has two-point events, which are shared by the trace function and the hardware break function. Specify whether or not to use the trace point function.

- When not using the trace point function (default), deselect the check box. In this case, the events are used for the hardware break function.
- To use the trace point function, check this box. In this case, the events are used for the trace point function. The hardware break function is disabled.

5. Executing the self-check

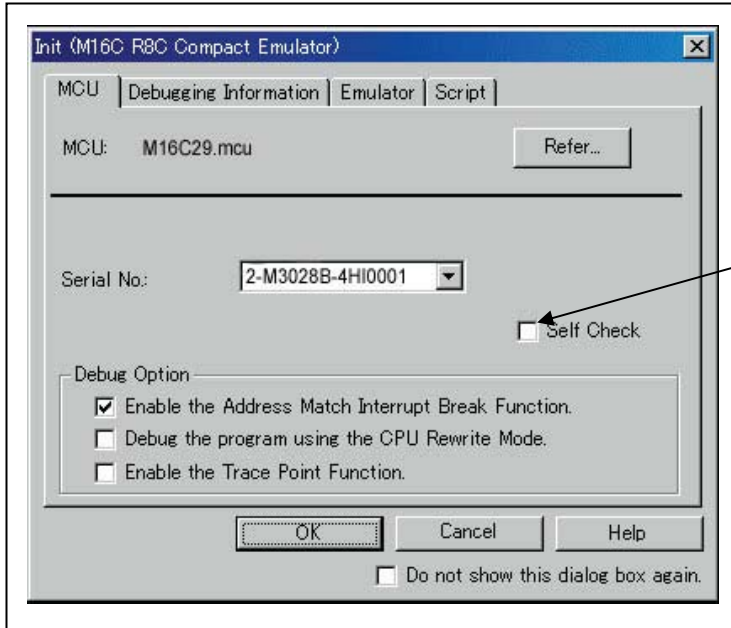

Executing the self-check

Enable this function when you want the emulator to be self-checked at startup. Be sure to select the check box only when you want the emulator to be self-checked at startup.

This function may be enabled in the following cases:

- When you are using the emulator you have just purchased
- When you successfully download the firmware, but fail to start up the emulator
- When you want to confirm whether the emulator is operating normally because, for example, the MCU runs out of control or something is wrong with the trace results

This function can be enabled only when you are starting up the emulator debugger.

(2) Debugging Information tab

1. Specifying the compiler used and the object format

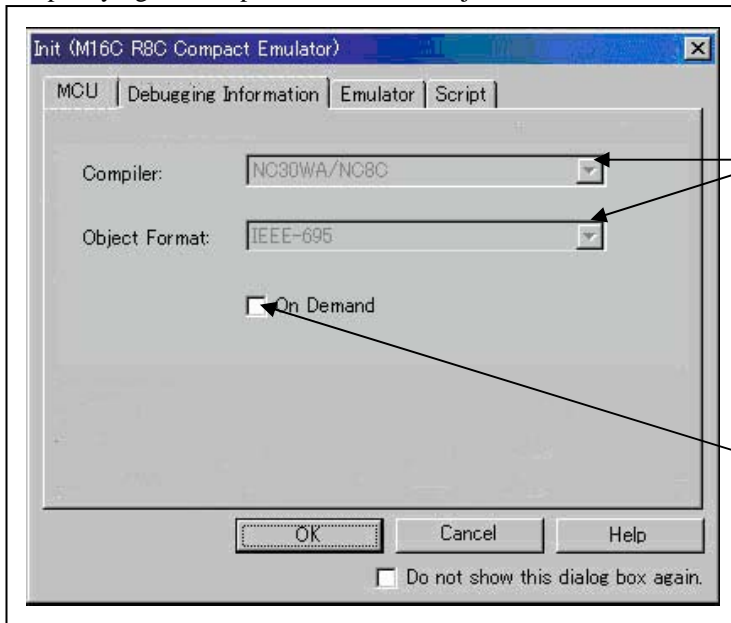

Specifying the compiler used and the object format

Displays the compiler used and its object format. Please specify the compiler used and its format in the dialog opened by menu [Debug]->[Debug settings...].

Specifying the method for storing debug information

There are two methods for storing debug information: on-memory method and an on-demand method.

When selecting the on demand method, check the [On Demand] check box.

- On Memory
Debugging information is stored in the internal memory of your computer. This method is suitable when the load module (user program) size is small.
- On Demand
Debugging information is stored in a reusable temporary file on the hard disk of your computer. Because the stored debugging information is reused, the next time you download the same load module it can be downloaded at high speed. This method is suitable when the load module (user program) size is large.

(3) Emulator tab

1. Specifying the target clock

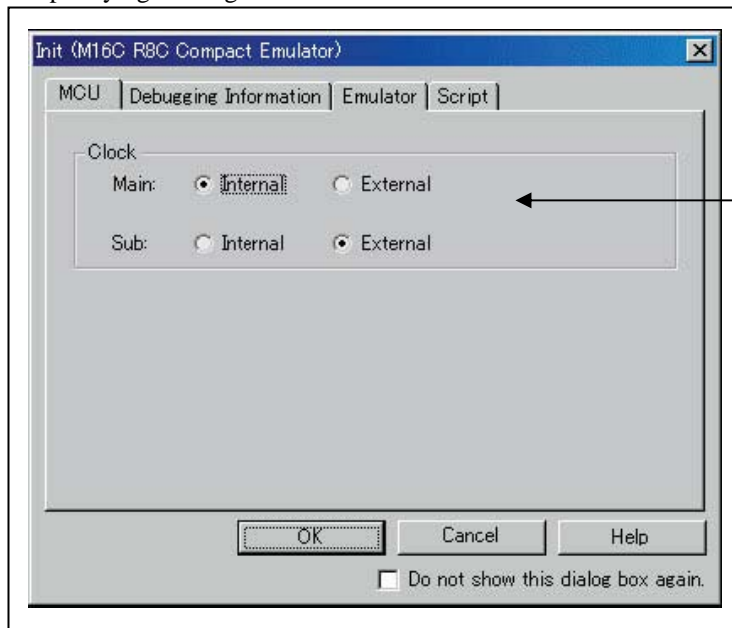
**Specifying the target clock**

Specify the clock sources supplied to the MCU (main clock and sub clock). Select the appropriate clock sources according to the clock used by your target MCU.

- Internal
Emulator's internal clock
- External
User system clock

The option you have specified here remains effective the next time you start up.

(4) Script tab

1. Automatically executing a script command

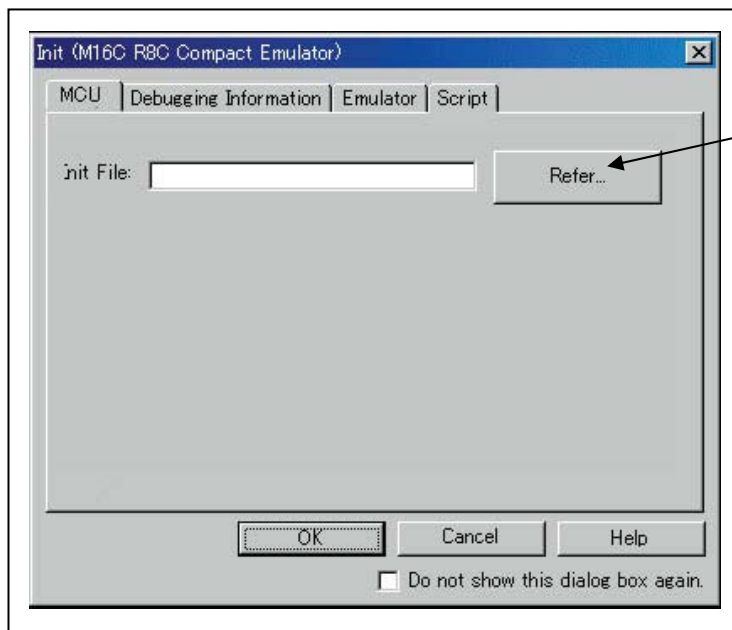
**Automatically executing a script command**

To automatically execute a script command when starting up the debugger, click the "Refer..." button and specify the script file to be executed.

Clicking the "Refer..." button brings up a file selection dialog box. The script file you have selected is displayed in the Init File: section of the dialog box shown here. If you do not want to automatically execute a script command, delete the character string displayed in the Init File: section of the dialog box.

What you specify here is reflected at only startup. If you specify back again in the Init dialog box after startup, whatever you specified has no effect. (Be sure to restart the emulator debugger.)

When you have finished the settings (1) to (4) above, click OK.

3.3 MCU Setting Dialog Box

The MCU Setting dialog box is used to set the user system information. It is displayed after you closed the Init dialog box.

(1) MCU tab

1. Specifying the processor mode

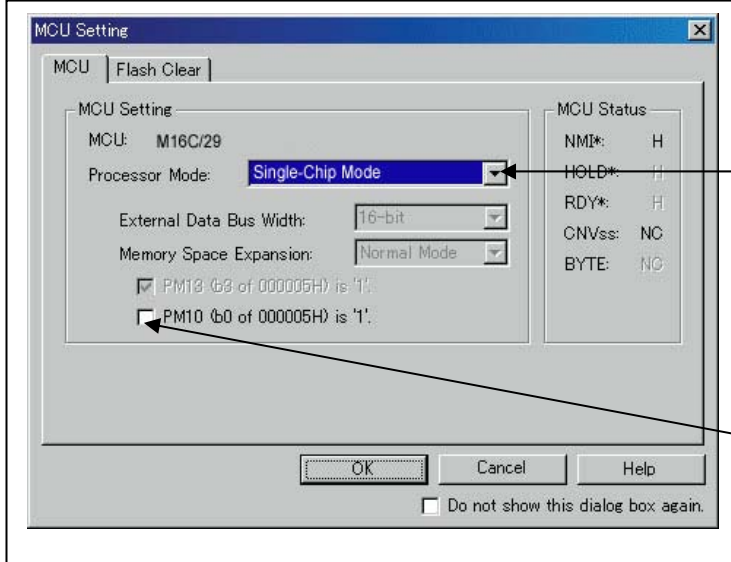

Specifying the processor mode
Select the appropriate processor mode that suits your system. For this product, you can specify only the following processor mode:
- Single-Chip Mode

Specifying the PM10 area (bit 0 of the address 00005h)
Select this option when using the MCU in which the data area access enable bit (PM10) is set to 1.

2. Referring to the MCU Status

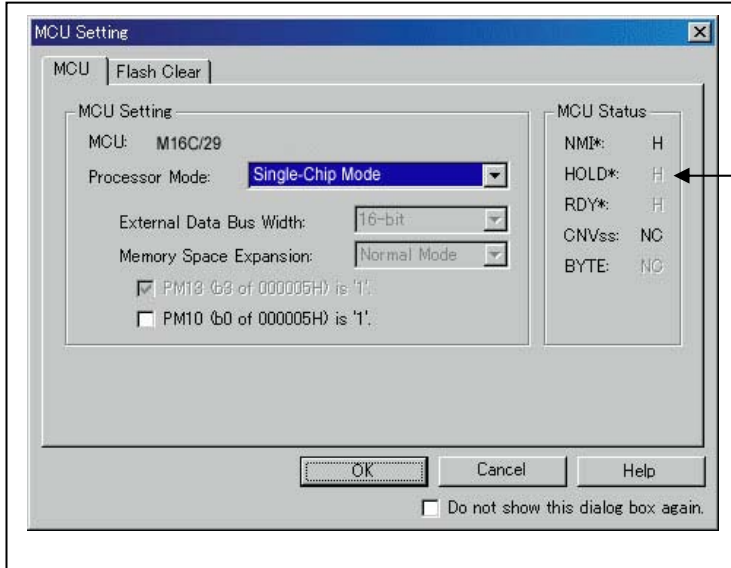

Referring to the MCU Status
It shows the pin status of the user system. Check it to see if the MCU status matches the selected processor mode. If the status of any pin is marked "NC", it means that the pin status is indeterminate.

(2) Flash Clear tab

1. Setting to clear the MCU's internal flash ROM

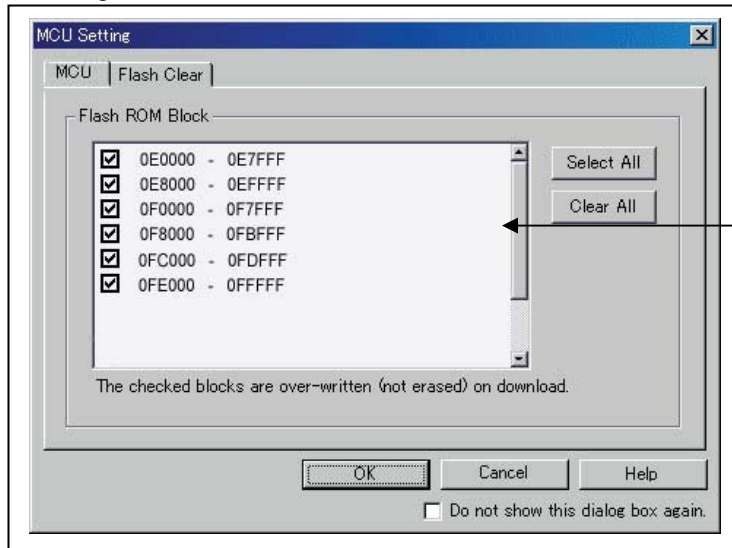
Setting to clear the MCU's internal flash ROM

Specify whether or not you want the MCU's internal flash ROM to be cleared when downloading the user program or data. (When cleared, the content of the flash ROM is initialized to FFh.) The MCU's internal flash ROM is listed in block units.

- Any block which has had its check box selected is not cleared when downloading. The memory content of this block remains intact unless overwritten by downloading.
- Any block which has had its check box deselected is cleared when downloading.
- Click the Select All button, and all blocks will be selected (marked by a check mark, so that none of the blocks is cleared when downloading).
- Click the Clear All button, and all blocks will be deselected (check marks removed, so that all of them are cleared when downloading).

The option you have specified here remains effective the next time you start up.

When you have finished the settings of (1) to (2), click OK.

3.4 Checking Connections of the Emulator System

Check to see that the emulator debugger has been connected correctly to the emulator.

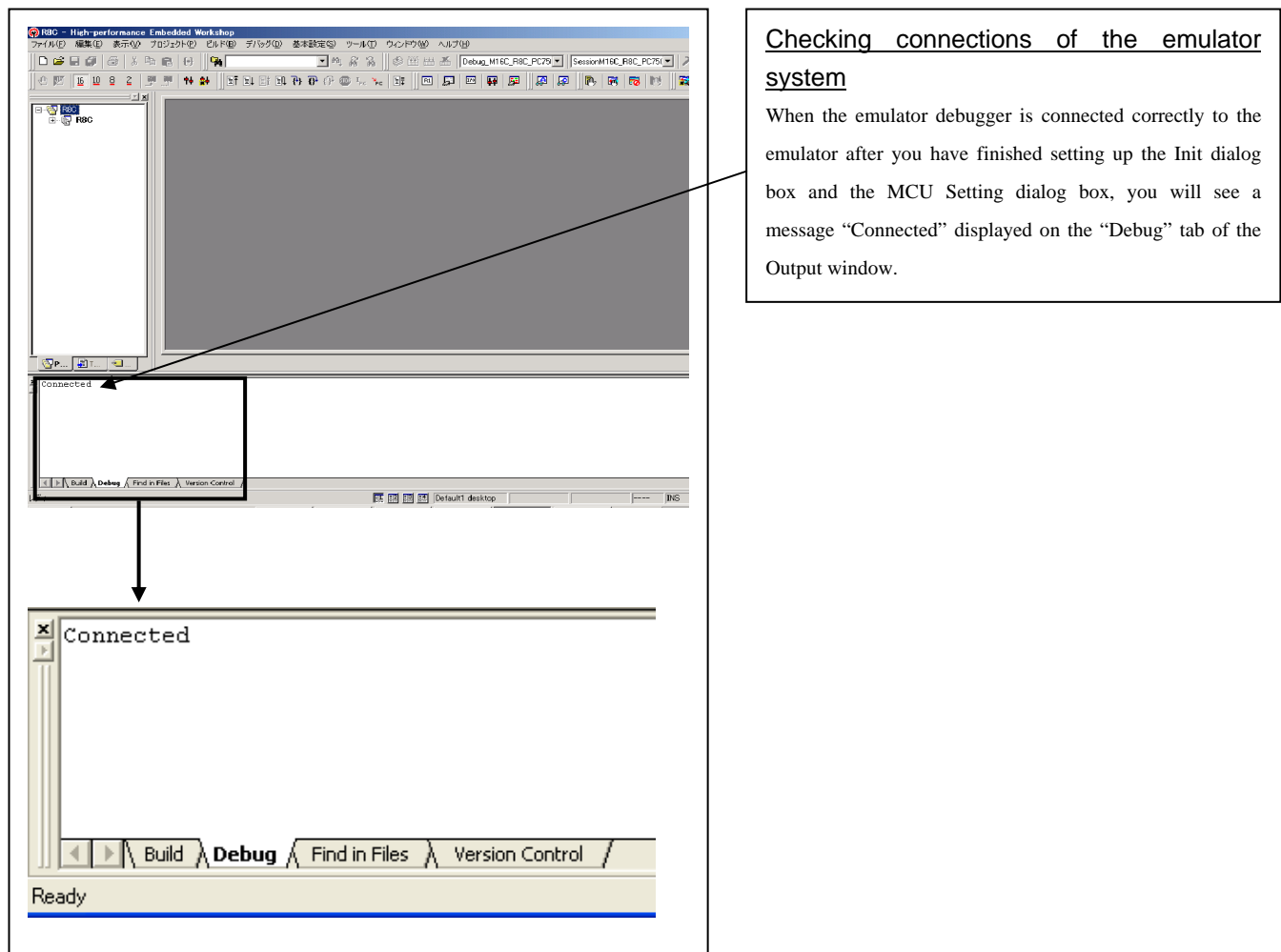

3.5 Program Execution

(1) Downloading the program

1. Downloading from the work space window

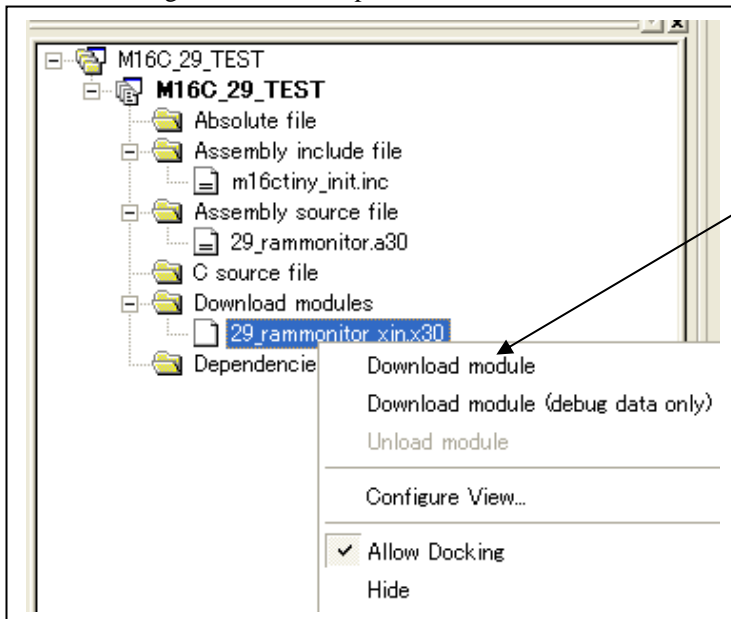

Downloading the program
 Download the object program you want to debug.
 Select Download from “xxx.x30” of “Download module”.
 Or you can select “Download module” from the “Debug” menu for the same effect.

2. Showing the source program

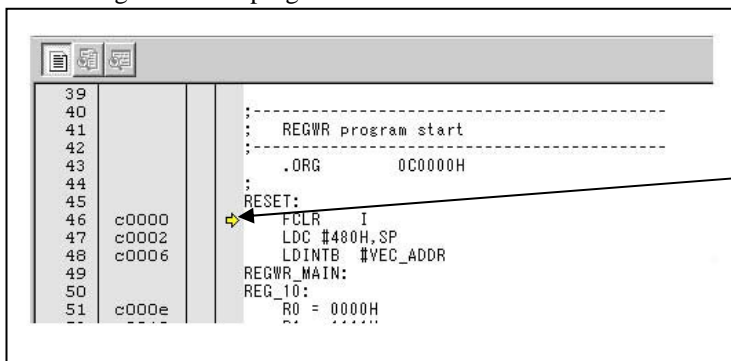

Editor (source) window
 The editor (source) window is a window that always shows the content of the source file corresponding to the current position of the program counter (hereafter, PC).
 The PC position is identified by the yellow background color. Here, you can execute the program up to the cursor position, and set or clear software breakpoints.
 Because the present emulator uses the MCU’s internal flash ROM, the initial value for the ROM area data at the time of purchase is “FFh.”

(2) Program execution

1 Resetting the user program

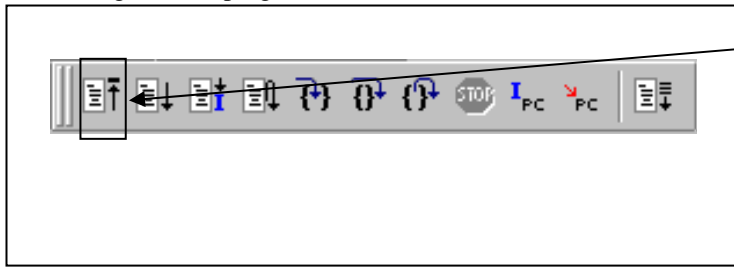

CPU reset
Resets the target MCU.

Or you can select "CPU Reset" from "Debug" menu for the same effect.

2 Executing the user program (Go)

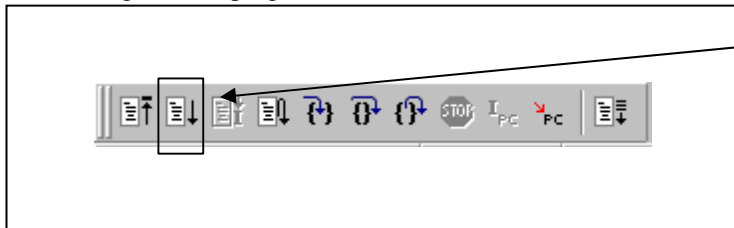

Go
Runs the program beginning with the current PC position.

Or you can select "Go" from "Debug" menu for the same effect.

3 Executing the user program (Go Free)



Go Free
Runs the program beginning with the current PC position. The software and hardware breaks set in it are ignored.

4 Executing the user program (Reset Go)

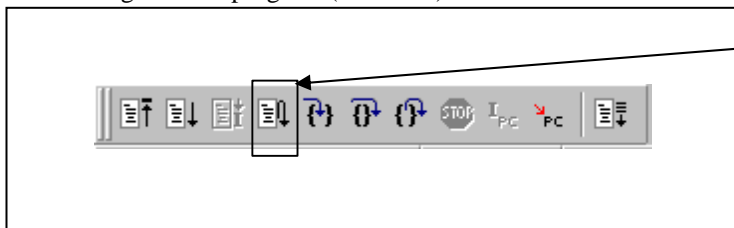

Reset Go
Runs the program after reset.

Or you can select "Reset Go" from "Debug" menu for the same effect.

5 Step execution of the user program

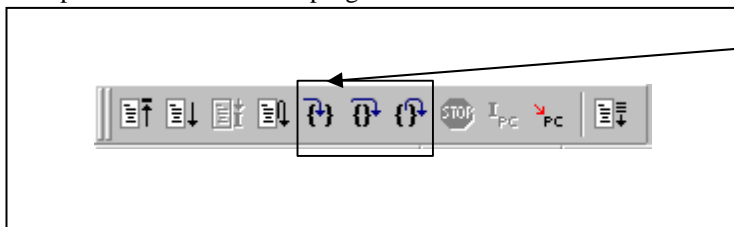

Step In
Single-steps the program executing each statement (including those in functions).
Step Over
Single-steps the program executing each function call as one step.
Step Out
Exits a function and stops at a statement in the program next to the one that called the function.

Or you can select "Step In" or other corresponding commands from "Debug" menu for the same effect.

6 Stopping the user program

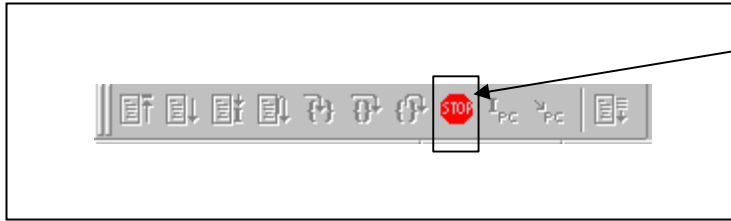
**STOP**

Stops the program.

Or you can select "Stop" from "Debug" menu for the same effect.

7 Editor (Source) window after you have stopped the user program

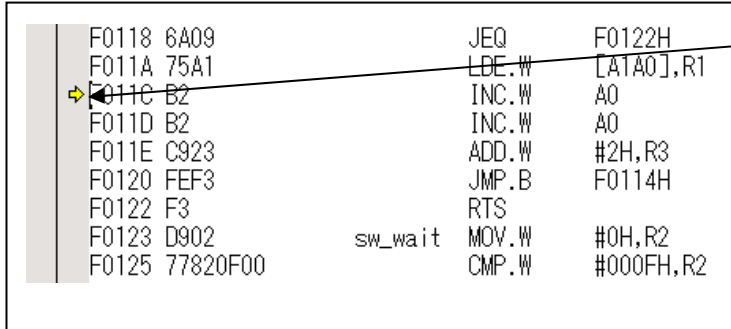
**Editor (Source) window**

The position at which the user program has stopped is marked by a yellow arrow.

(3) Setting breakpoints

1. Screen after breakpoint setup

```

63      N_BZERO .macro TOP_,SECT_
64      f0039   mov.b   #00H, R0L
65      f003a   mov.w   #(TOP_ & 0FFFFH), A1
66      f003d   mov.w   #sizeof SECT_, R3
67      f0041   sstr.b
68      .endm
69
70      N_BCOPY .macro FROM_,TO_,SECT_
71      f0061   mov.w   #(FROM_ & 0FFFFH), A0
72      f0064   mov.b   #(FROM_ >>16), R1H
73      f0067   mov.w   #TO_, A1
74      f006a   mov.w   #sizeof SECT_, R3
75      f006e   smovf.b
76      .endm
77
78      BZERO .macro TOP_,SECT_
79      f009d   push.w  #sizeof SECT_ >> 16
80      f00a1   push.w  #sizeof SECT_ & 0ffffh
81      f00a5   pusha  TOP_ >>16
82      f00a9   pusha  TOP_ & 0ffffh
83

```

Screen after breakpoint setup

There are three types of breakpoints as described below.

- Address match breakpoint

This breakpoint can be set only when you chose to use the address match break function on the MCU tab of the Init dialog box.

A breakpoint can be set or cleared by double-clicking in the address match breakpoint display area in the editor (source) window. (A blue circle is displayed at the setting line)

Up to six breakpoints can be set.

The address match break causes the program to stop before executing the address at which a breakpoint is set.
- Software breakpoint

A software breakpoint can be set or cleared by double-clicking the software breakpoint display area in the editor (source) window (A red circle is displayed at the setting line).

This is rewritten to a break instruction, therefore, because of rewriting flash ROM, program execution starts with a delay of several seconds after setting ROM area.

If the breakpoint you set is a software breakpoint, the program stops before executing the instruction at the set breakpoint.
- Hardware breakpoint

A hardware breakpoint can be set or cleared by right-clicking the breakpoint display area.

If the breakpoint you set is a hardware breakpoint, the program stops after executing the instruction at the set breakpoint (after several cycles).

(4) Executing up to the cursor position

1. Setup procedure for running the program up to the cursor position

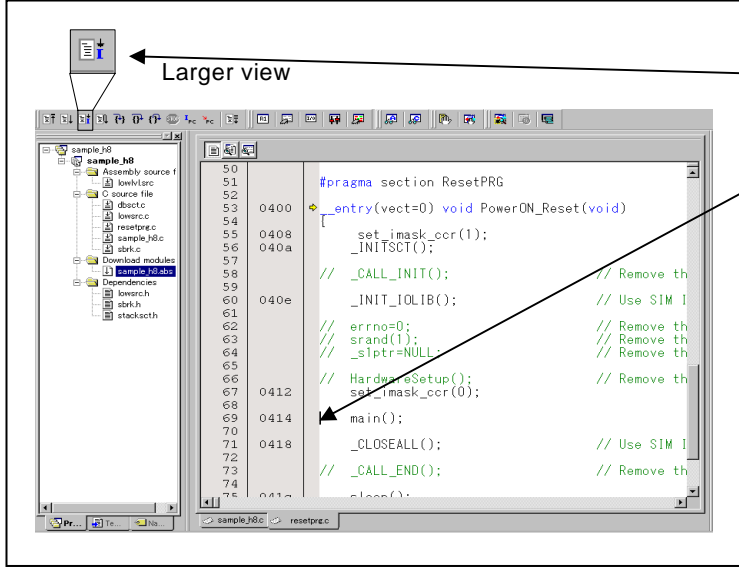

Setup procedure for running the program up to the cursor position

- (1) Click the line in the editor (source) window that you want to be executed.
- (2) Click the execution button to the cursor position.

Or you can select "Go to Cursor" from "Debug" menu for the same effect.

2. After the execution has finished

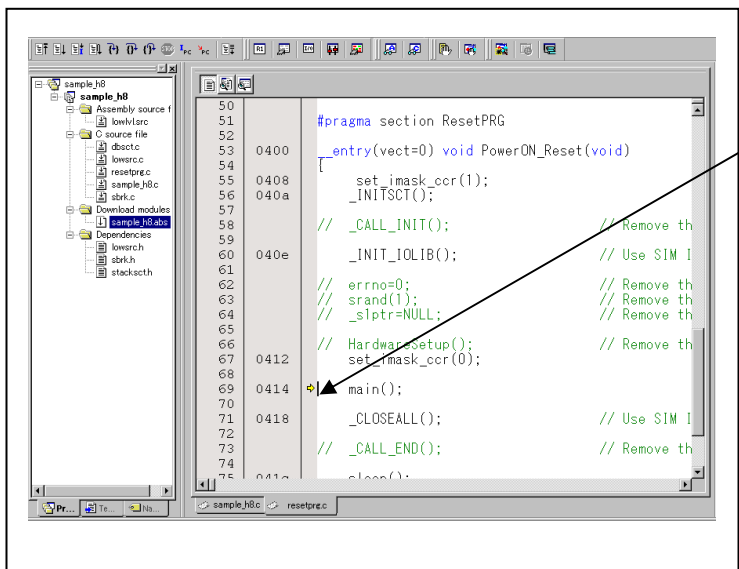

The cursor stops in the position where the come command was executed.

The statement specified with the come command is not executed.

3.6 Hardware Breakpoint Setting Window

(1) Breakpoint setup dialog box

1. Opening the hardware breakpoint setup dialog box

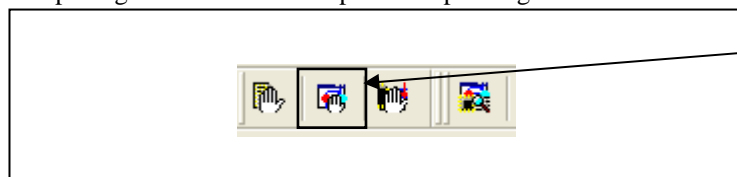

Hardware Break Point
 Clicking this button opens the hardware breakpoint setup dialog box.

2. Hardware Break Point Setting Window in initial state

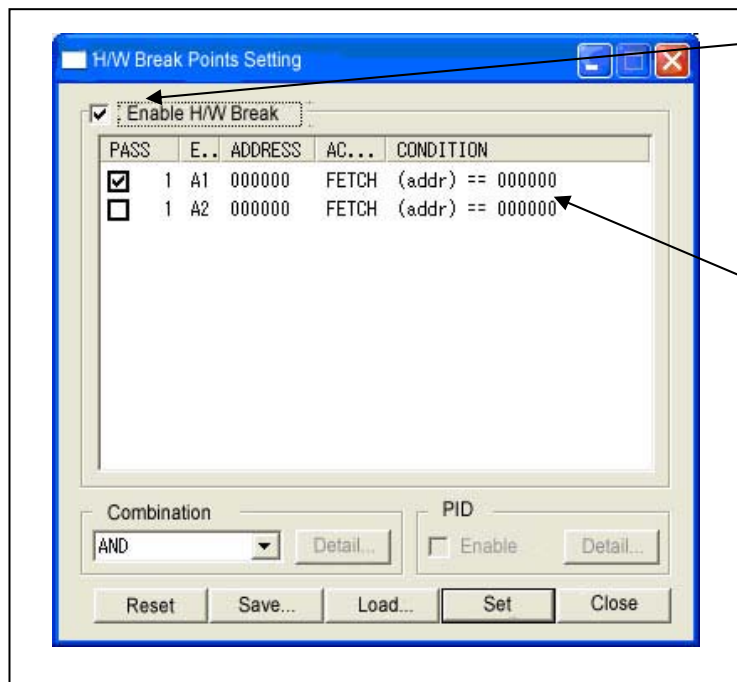

H/W breakpoint Setting Window in initial state
 Select the "Enable H/W Break" check box, and this break function will be enabled, allowing you to set hardware breakpoints.

Setting Break Event
 Click the event line at which you want set a break event.

3. Break event setting dialog box

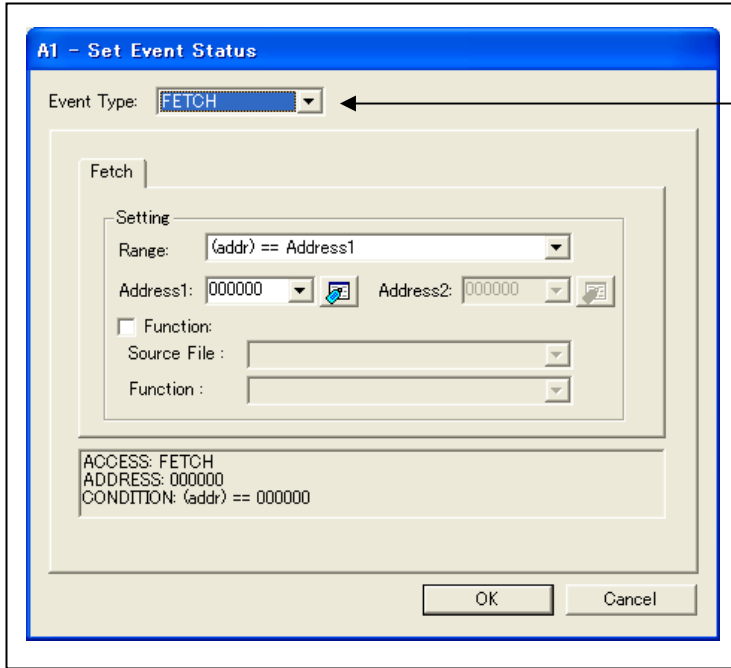

Specifying the event type
Select the event type that you want to set from the drop-down list.

- FETCH
Detects an instruction prefetch.
- DATA ACCESS
Detects a memory access.
- BIT SYMBOL
Detects a bit access.

(2) When FETCH is selected

1. Window for setting addresses

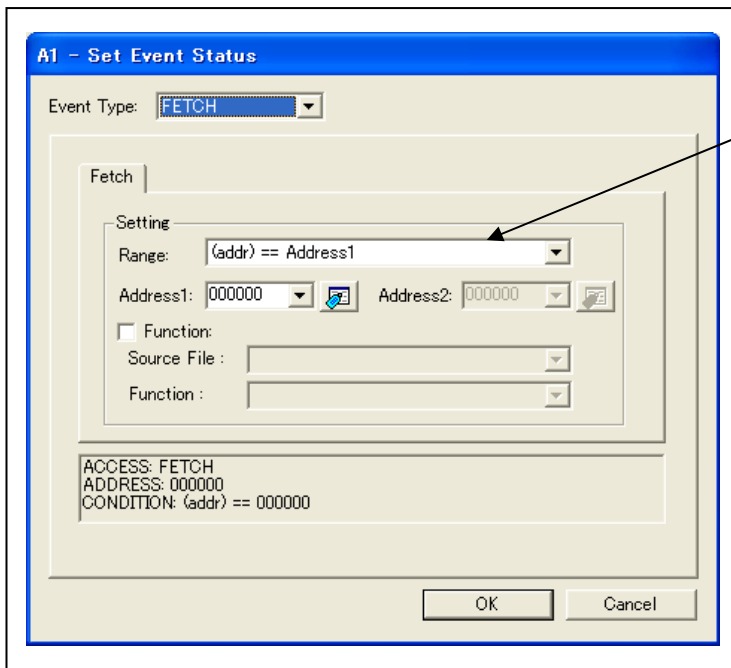

Setting the address
You can set eight conditions, e.g., a specified address, a specified address range, etc. When you have finished setting the address, click OK.

(3) When DATA ACCESS is selected

1. Window for setting the address

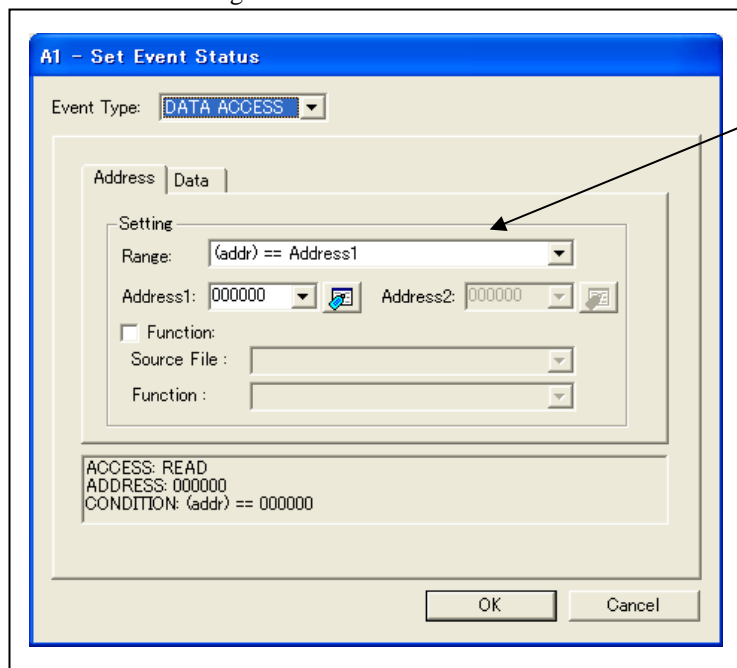

Setting the address
 You can set eight conditions, e.g., a specified address, a specified address range, etc.

2. Window for setting data

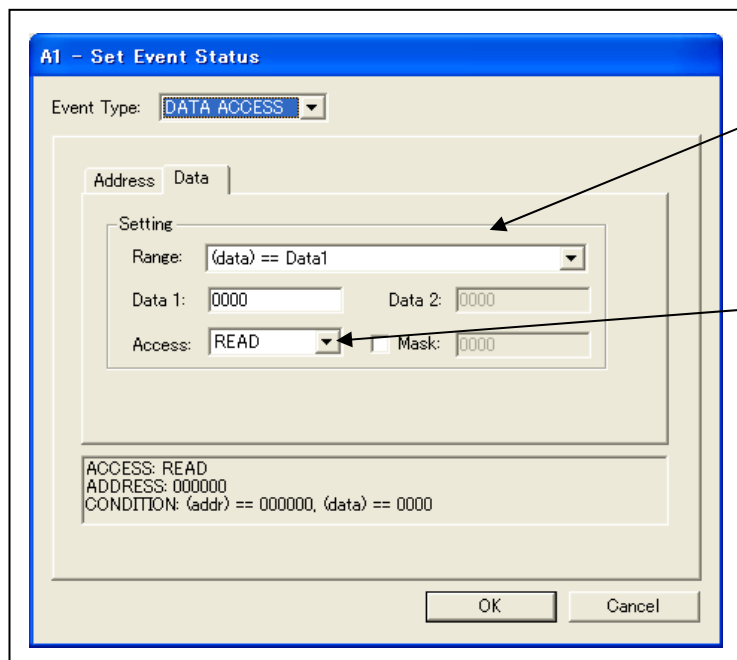

Setting data
 You can set two conditions, e.g., specified data or not to compare data.

Setting the access condition
 You can set three conditions, e.g., read, write, and read/write. When you have finished setting the data and access condition, click OK.

3. Example Data Settings

Event setting for even-address word access

MOV.W R0,512h(R0=0203h)

Cycle	Label	Address	Data	BUS	BHE	BIU	R/W	RWT	CPU
-00059		000512	0203	16b	0	DW	W	0	RW

High-order and low-order data effective

Event setting for odd-address word access

MOV.W R0,519h(R0=0203h)

Cycle	Label	Address	Data	BUS	BHE	BIU	R/W	RWT	CPU
-00026		000519	0302	16b	0	DW	W	0	CW
-00025		00051A	0302	16b	1	DW	W	0	--

Odd-address high-order data effective

Even-address low-order data effective

Event setting for even-address byte access

MOV.B R0L,516h(R0L=03h)

Cycle	Label	Address	Data	BUS	BHE	BIU	R/W	RWT	CPU
-00033		000516	0503	16b	1	DB	W	0	RW

Low-order data effective

Event setting for odd-address byte access

MOV.B R0L,515h(R0L=03h)

Cycle	Label	Address	Data	BUS	BHE	BIU	R/W	RWT	CPU
-00046		000515	0315	16b	0	DB	W	0	RW

High-order data effective

Setting a break event

A1

Address 1 : 000512

Data 1 : 0203

MASK : FFFF

Access : WRITE

Setting a break event (using 2 events)

A1

A2

Address 1 : 000519 Address 1 : 00051A

Data 1 : 0300 Data 1 : 0002

MASK : FF00 MASK : 00FF

Access : WRITE Access : WRITE

Set the combinatorial events to AND.

Setting a break event

A1

Address 1 : 000516

Data 1 : 0003

MASK : 00FF

Access : WRITE

Setting a break event

A1

Address 1 : 000515

Data 1 : 0300

MASK : FF00

Access : WRITE

(4) Setting the hardware breakpoint combinatorial condition

1. Window for setting the combinatorial condition

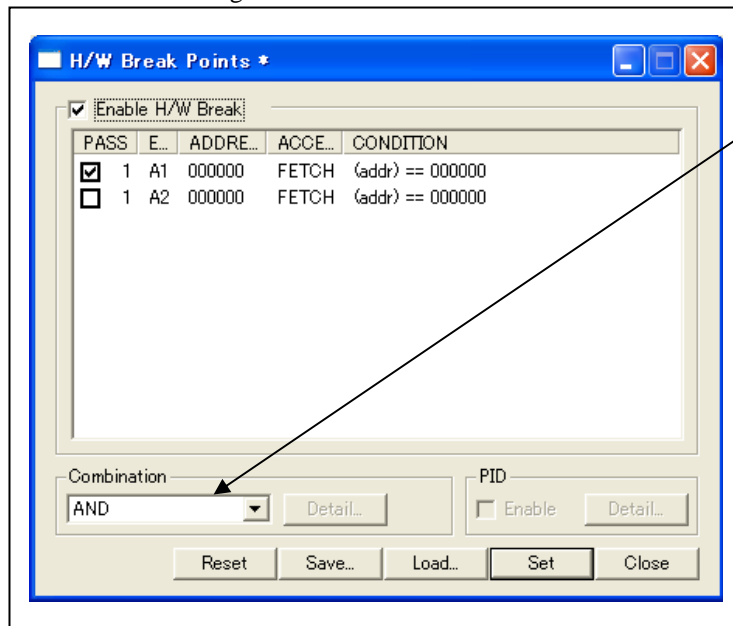
**Setting the combinatorial condition**

There are following three conditions that you can choose for the combinatorial condition.

- OR

The program breaks when one of the specified events occurs.

- AND

The program breaks when all of the specified events occur.

- AND (Same Time)

The program breaks when the specified events occur at the same time.

For each event, a pass count (number of passing) is specifiable (1--255). When "AND (same time)" is specified for Combination, you can not specify the pass count (fixed to one).

When you have finished setting the combinatorial event condition, click the "Set" button.

3.7 Trace Window

(1) Trace window

1. Opening the trace window

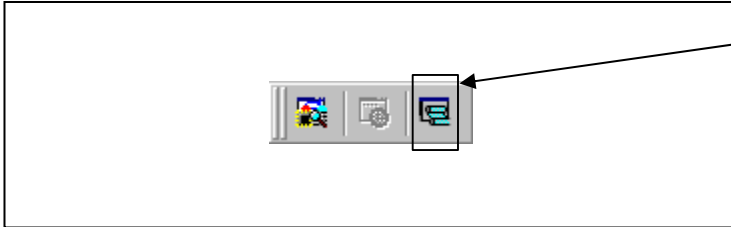

Trace window

Clicking this button opens the trace window.

Or you can select "Trace" from "Trace" of "Display" menu for the same effect.

2. Trace window

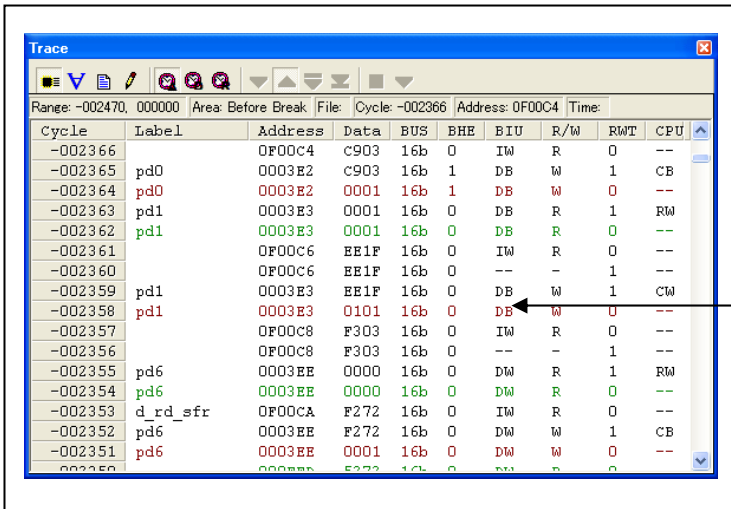

Trace window

The trace window is used to show the results of real-time trace measurements. It has the following three display modes:

- Bus mode 

Bus information per cycle can be inspected. The contents are displayed in order of execution paths.
- Disassemble mode 

The execution paths of the executed instructions can be inspected. The contents are displayed in order of execution paths.
- Source mode 

The execution paths of the source program can be inspected.
Operating buttons of the tool bar can reference the execution paths.

The trace window shows the measurement result when a real-time trace measurement has finished. The trace window remains blank until the real-time trace measurement in progress finishes.

3. Trace window (bus display)

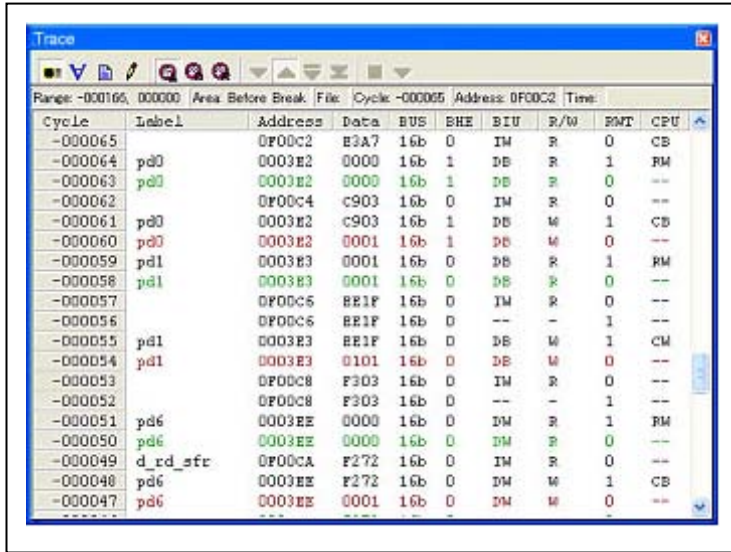

Explanation of the trace window (bus display)

The following explains the displayed contents, from left to right.

- Cycle
Shows trace cycles. Double-click here to bring up a dialog box to change the displayed cycle.
- Label
Shows labels corresponding to address bus information. Double-click here to bring up a dialog box to search for addresses.
- Address
Shows the status of the address bus.
- Data
Shows the status of the data bus.
- BUS
Shows the width of the external data bus. In the present emulator, only "16b" for 16 bits wide bus is displayed.
- BHE
Shows the status (0 or 1) of the BHE (Byte High Enable) signal. If this signal = 0, the odd-address data is valid.
- BIU
Shows the status between the BIU (Bus Interface Unit) and memory or I/O.

4. Trace window (disassemble display)

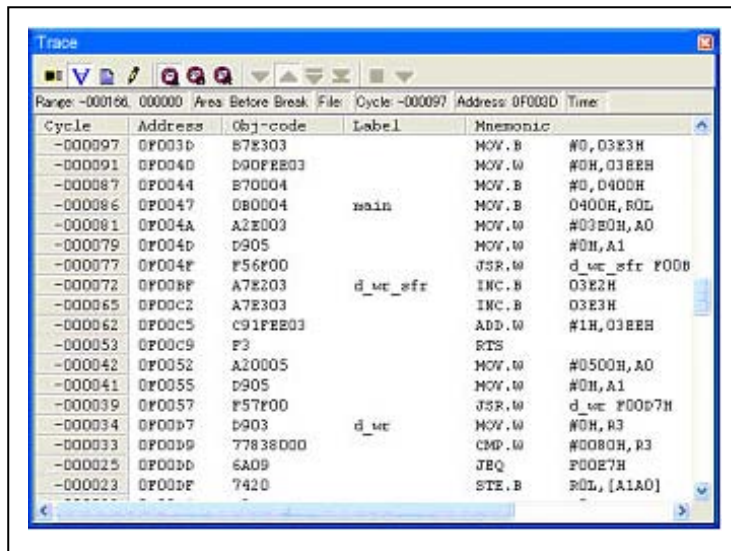

- R/W
Shows the status of the data bus. Displayed as "R" for Read, "W" for Write, and "-" for no access.
- RWT
This is the signal to indicate a valid bus cycle. When valid, RWT = 0. The Address, Data, and the BIU signals are effective when this signal is 0.
- CPU
Shows the status between the CPU and BIU (Bus Interface Unit).

5. Trace window (source display)

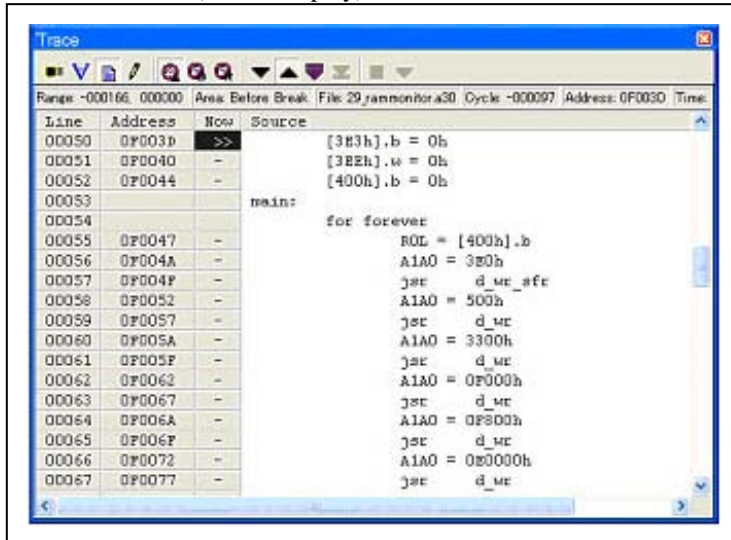

- CPU
Shows the status between the CPU and BIU (Bus Interface Unit).
- | | |
|--------|--------------------------------|
| Symbol | Status |
| - | Non-active |
| CB | Op-code read (in bytes) |
| RB | Operand read (in bytes) |
| QC | Instruction queue buffer clear |
| CW | Op-code read (in words) |
| RW | Operand read (in words) |

(2) Suspending and resuming trace measurement

1. Suspending trace measurement

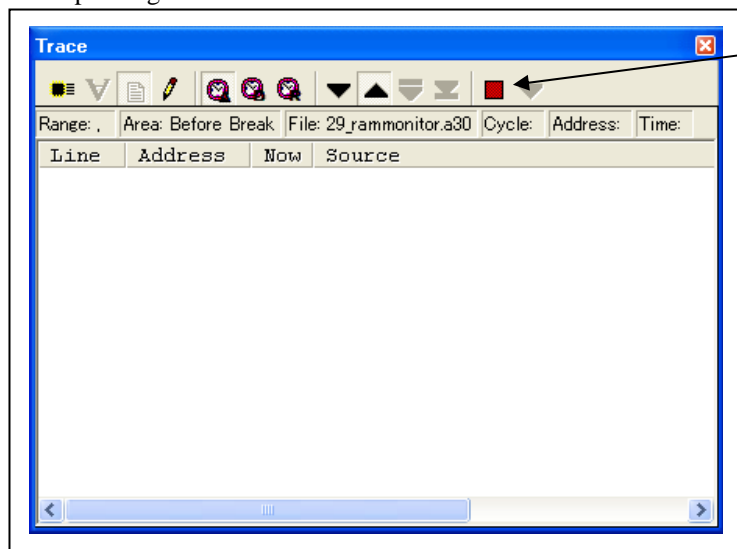

Stop
Click this toolbar button to suspend the trace measurement in progress.

2. Resuming trace measurement

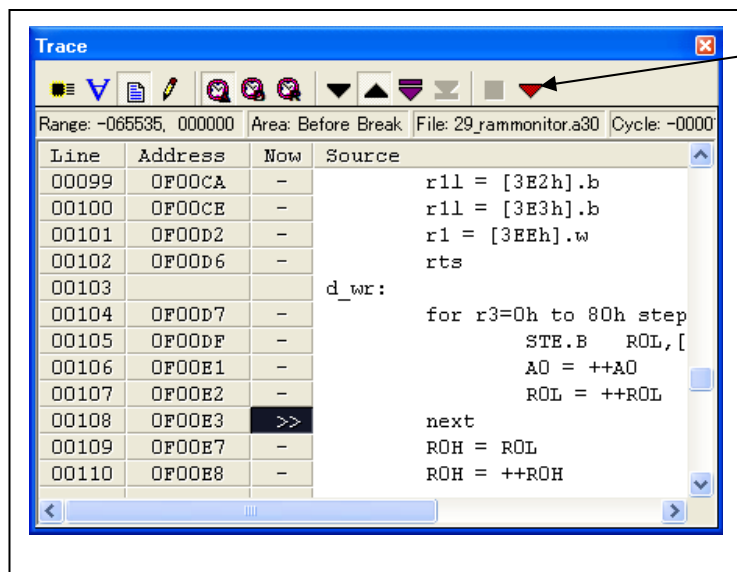

Re-Start
Click this toolbar button to resume the trace measurement in progress.

(3) Trace point setup dialog box

1. Opening the trace point setup dialog box

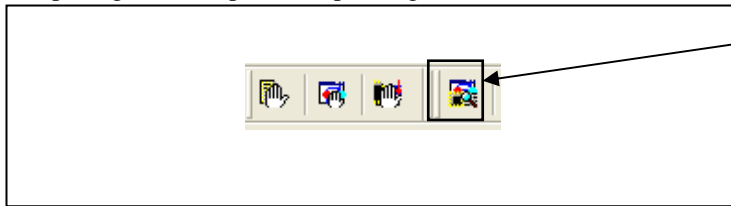
**Trace Point**

Clicking this toolbar button opens the trace point setting window.

2. Trace Point Setting Window in initial state

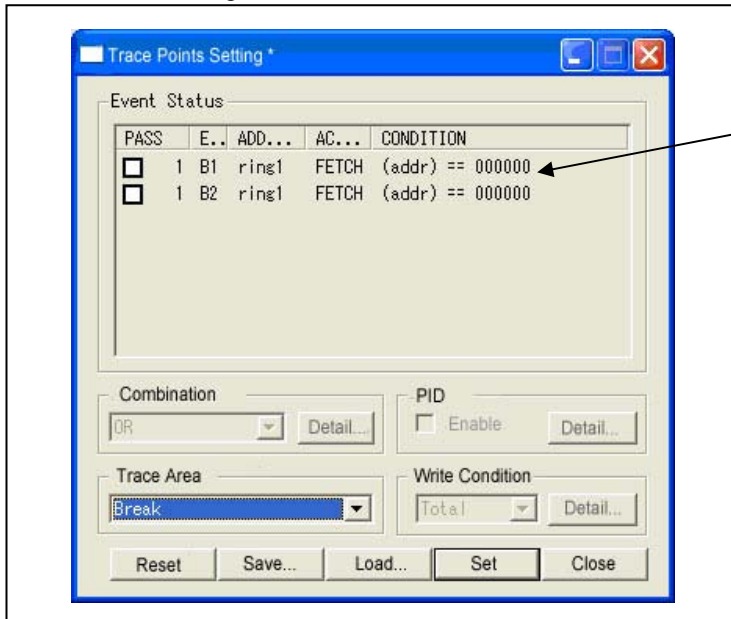
**Trace Point Setting Window in initial state**

Be sure to select "Enable the trace point" in the Init dialog box. Here, you can set events in the same way as for the hardware breakpoints.

3. Specifying a trace area

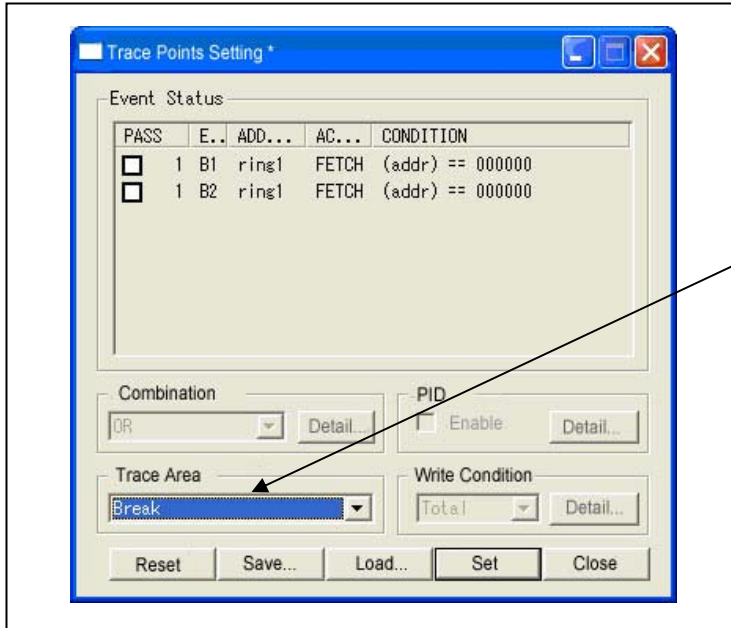

Specifying a trace area

You can specify a trace range for the trace event.

- Break
64K cycles of instruction execution before the user program stopped is recorded.
- Before
64K cycles of instruction execution before a trace point condition was met is recorded.
- About
32K cycles of instruction execution before and after a trace point condition was met is recorded.
- After
64K cycles of instruction execution after a trace point condition was met is recorded.
- Full
64K cycles of instruction execution after a trace began is recorded.

4. Setting the trace write condition

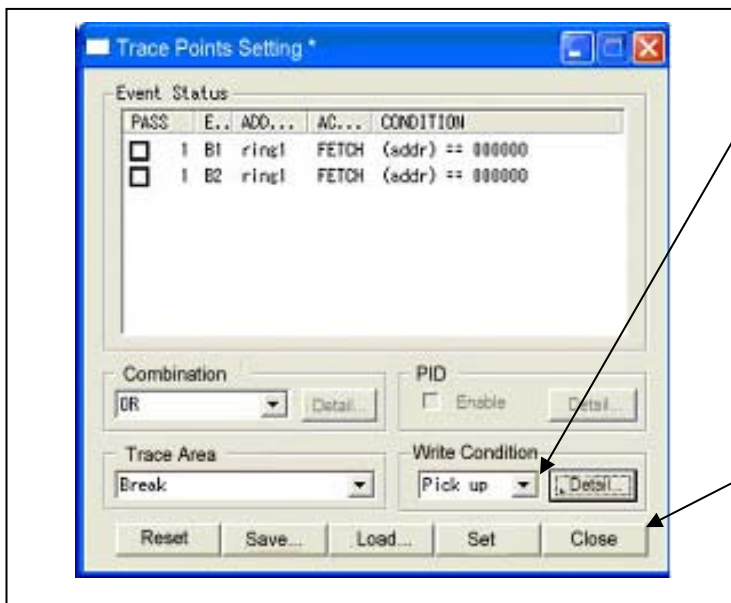

Setting the trace write condition

You can specify a condition for the cycles to be written into the trace memory.

- Total
All cycles are written into memory.
- Pick up
Only the cycles in which the specified condition was met are written into memory.
- Exclude
Only the cycles in which the specified condition was not met are written into memory.

When you have finished setting the trace write condition, click this button. The Realtime-trace Write Condition dialog box shown below will appear.

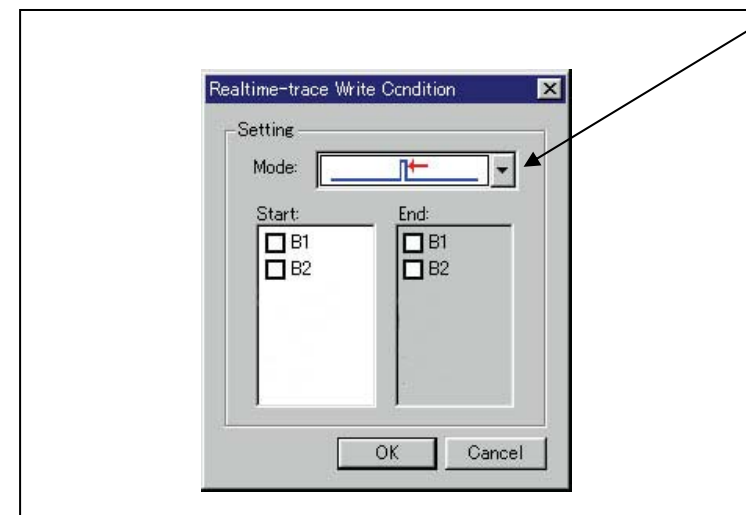

Write mode



Only the cycle in which the specified Start event occurred



A range of cycles from when the specified Start event occurred to when the specified Start event became nonexistent



A range of cycles from when the specified Start event occurred to when the specified End event occurred

3.8 RAM Monitor Window

(1) RAM monitor window

1 Opening the RAM monitor window

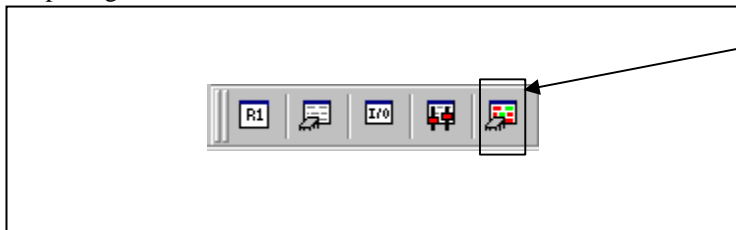

RAM monitor
 Clicking this button opens the RAM monitor window.
 Or you can select “RAM monitor” from “CPU” of “Display” menu for the same effect.

2. RAM monitor window

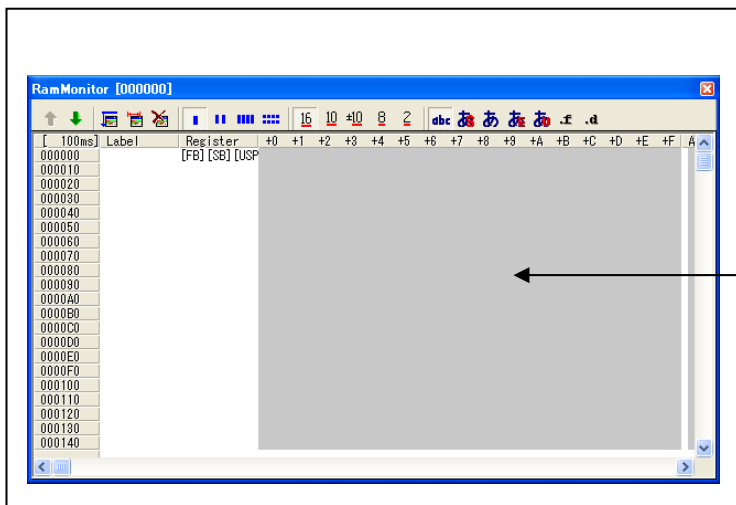

RAM monitor window
 This window shows changes of memory contents while the user program is executed. This is accomplished by using the real-time RAM monitor function, and the memory contents corresponding to the RAM monitor area are displayed in dump form. The memory contents displayed here are updated at given intervals (by default, every 100 ms) during user program execution.

(2) RAM monitor area setting window

1. Opening RAM monitor area setting window

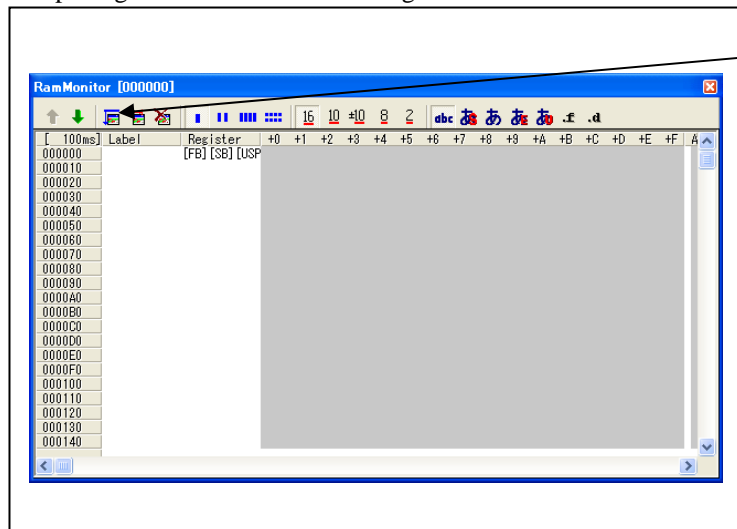

RAM monitor area setting
 Clicking this toolbar button opens the RAM monitor area setting window.

2. RAM monitor area setting window in initial state

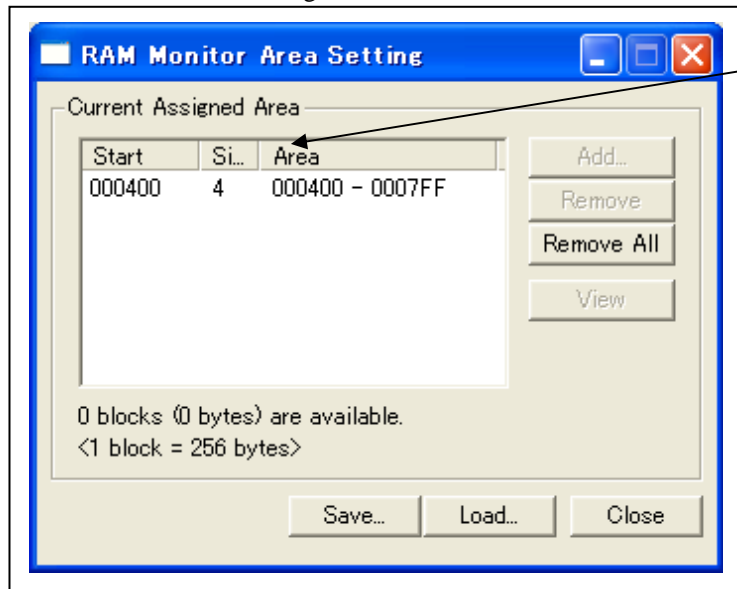

RAM Monitor Area Setting Window in initial state
 By default, the monitor area is set to 000400h through 0007FFh. To change it, click the "Add..." or "Remove" button.

3. RAM monitor area setting dialog box

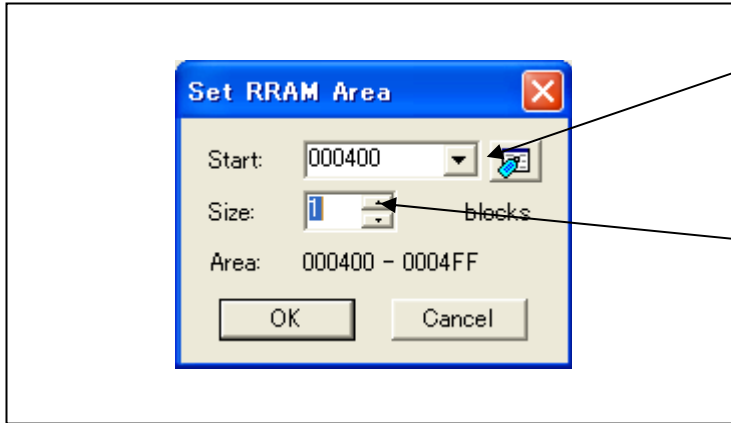

Specifying the start address
 You can set the start address of the RAM area to be monitored.

Specifying the size
 You can set the size to be monitored by specifying the number of blocks from the start address. One block is 256 bytes in size.

4. RAM monitor area setting dialog box when RAM monitor area is changed from 400h to 1 block

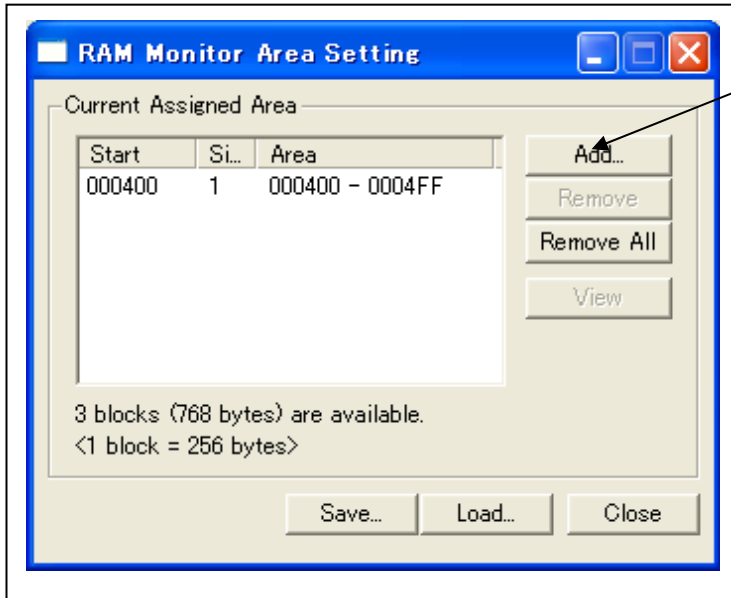

Specifying the start address
 You can set the start address of the RAM area to be monitored. To add a RAM monitor area, click the "Add..." button. The RAM Monitor Area Setting Window will be displayed.

5. RAM monitor area setting dialog box

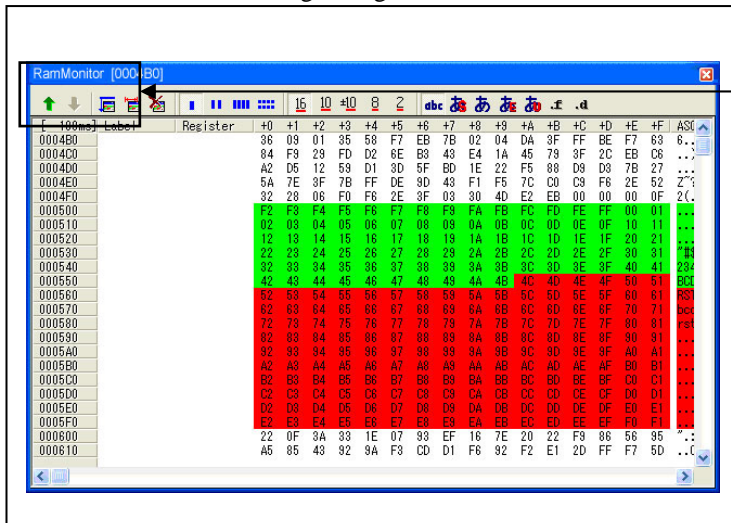

Changing the RAM monitor display area
 You can change the manner in which the RAM monitor area you have set in the above dialog box is displayed.

- ↑ Shows the blocks at the preceding addresses.
- ↓ Shows the blocks at the following addresses.

The background colors of the data display and the code display sections change with the access attribute as described below.

- Green Addresses accessed for read
- Red Addresses accessed for write
- White Addresses not accessed

The background colors can be changed as necessary.

4. Hardware Specifications

This chapter describes specifications of this product.

4.1 Target MCU Specifications

Table 4.1 lists the specifications of target MCUs which can be debugged with this product.

Table 4.1 Specifications of target MCUs for the M3028BT2-CPE

Item	Description
Applicable MCU	M16C/Tiny Series
Applicable MCU mode	Single-chip mode
Max. ROM/RAM capacity	1. Internal flash ROM: 128KB+4KB 0F000h--0FFFFh, E0000h--FFFFFFh 2. Internal RAM: 12KB 00400h--033FFh
Maximum operating frequency	Power voltage at 4.2 to 5.5V: 24MHz (for 24MHz: when using PLL) Power voltage at 3.0 to 5.5V: 20MHz Power voltage at 2.7 to 5.5V: 10MHz

4.2 Differences between the Actual MCU and Emulator

Differences between the actual MCU and emulator are shown below. When debugging the MCU using this product, be careful about the following precautions.

IMPORTANT

Note on Differences between the Actual MCU and Emulator:

- Operations of the emulator system differ from those of actual MCUs as listed below.
 - (1) Reset condition
Set the time for starting up (0.2 VCC to 0.8 VCC) 1 μ s or less.
 - (2) Initial values of internal resource data of an MCU at power-on
 - (3) Interrupt stack pointer (ISP) after a reset is released
 - (4) Capacities of the internal memories (ROM and RAM)
The evaluation MCU of this product has RAM of 12KB (00400h--033FFh) and flash ROM of 4KB (0F000h--0FFFFh) and 128KB (E0000h--FFFFFFh).
 - (5) Oscillator circuit
In the oscillator circuit where an oscillator is connected between pins X_{IN} and X_{OUT}, oscillation does not occur because a package converter board is used between the evaluation MCU and the user system. For notes on when using an oscillator circuit on the user system, refer to "2.9.2 Selecting Clock Supply" (page 38). It is same for pins X_{CIN} and X_{COU}T.
 - (6) Xin input when resetting the MCU
When resetting the MCU, it is necessary to input a clock to the pin Xin.
 - (7) A/D conversion
The characteristics of the A/D converter differ from those of actual MCU because there are a converter board and other devices between the evaluation MCU and the user system.
 - (8) Operation after releasing the reset
After releasing the reset, for about up to 350 cycles, a program to control the emulator will be executed. Note that this will have an affect on a user program execution time and tracing result.

Note on RESET# Input:

- A low input to pin RESET# from the user system is accepted only when a user program is being executed (when the RUN status LED on the emulator's upper panel is lit).

Note on NMI# Input:

- A low input to pin NMI# from the user system is accepted only when a user program is being executed (when the RUN status LED on the emulator's upper panel is lit).

Notes on Maskable Interrupts:

- Even if a user program is not being executed (including when run-time debugging is being performed), the evaluation MCU keeps running so as to control the emulator. Therefore, timers and other components do not stop running. If a maskable interrupt is requested when the user program is not being executed (including Internal I/O access when run-time debugging is being performed), the maskable interrupt request cannot be accepted, because the emulator disables interrupts. The interrupt request is accepted immediately after the user program execution is started.
- Take note that when the user program is not being executed (including when run-time debugging is being performed), a peripheral I/O interruption is not accepted.

Note on DMA Transfer:

- With this product, the program is stopped with a loop program to a specific address. Therefore, if a DMA request is generated while the program is stopped, DMA transfer is executed. However, make note that DMA transfer while the program is stopped may not be performed correctly. Also note that the below registers have been changed to generate DMA transfer as explained here even when the program is stopped.
 - (1) DMA0 transfer counter: TCR0
 - (2) DMA1 transfer counter: TCR1

IMPORTANT

Note on Access Prohibited Area:

- You cannot use internally reserved areas. Write signals to the areas will be ignored, and values read will be undefined.

Notes on Stack Area:

- With this product, a maximum 8 bytes of the interrupt stack is consumed as a work area. Therefore, ensure the +8 byte maximum capacity used by the user program as the interrupt stack area.
If the interrupt stack does not have an enough area, do not use areas which cannot be used as a stack (SFR area, RAM area which stores data, or ROM area) as a work area. Using areas like this is a cause of user program crashes and destabilized emulator control.
- With this product, the interrupt stack pointer (ISP) is set at 00500h and used as a stack area after a reset is released.

Notes on Reset Vector Area:

- Memory in the emulator main unit is always selected as a reset vector area (FFFFCh--FFFFFh) in order to operate the evaluation MCU in the emulator-dedicated mode. Set the contents of the reset vector area in one of the following ways.
 - (1) Download a user program to an area including the reset vector area.
 - (2) Set the reset vector using a memory window of the emulator debugger etc.
- You can change data in the reset vector area only when the user program is stopped.
- Do not access the reset vector area as data. It may not be accessed properly.

Note on Accessing Addresses 00000h and 00001h:

- With the M16C/Tiny Series MCUs, when a maskable interrupt is generated, the interrupt data (interrupt number and interrupt request level) stored in addresses 00000h and 00001h are read out. Also, the interrupt request bit is cleared when address 00000h or 00001h is read out. Consequently, when the address 00000h or 00001h readout instruction is executed or when address 00000h or 00001h is read out in the cause of a program runaway, a malfunction occurs in that the interrupt is not executed despite the interrupt request, because the request bit of the highest priority interrupt factor enabled is cleared.

Note on Operating Frequency:

- You cannot use this product with a main clock (X_{IN} - X_{OUT}) less than 1MHz. To use it with a main clock less than 1MHz, contact your local distributor.

Note on Timeout Setting:

- If you download, execute or single-step a program at a low operating frequency, a communication timeout error may occur.

Execute the command shown below in the Script Window after starting the emulator debugger.

```
[Command]          _settimeout 300, 300
```

Once this command is executed, it remains effective the next time you start the emulator debugger. Therefore, you do not need to execute this command again.

If the error still occurs in this setting, contact your local distributor.

IMPORTANT

Notes on Applicable MCUs:

- This product is applicable to the M16C/Tiny Series MCUs. ROM, RAM size and peripheral functions vary depending on the target MCUs used. Before the program development, refer to each Hardware Manual of the M16C/Tiny Series. When developing the program of the M16C/26A and 28 Groups, do not access to the SFR which is not built in the M16C/26A and 28 Groups.
- With this product, the initial value of main clock stop bit (CM05) is different from that of the M16C/26A Group M16C/26T MCU. Note that the initial value of CM05 of this product is set to “0”, and that of the M16C/26A Group M16C/26T MCU is set to “1”.

Note on Final Evaluation:

- Be sure to evaluate your system with an evaluation MCU. Before starting mask production, evaluate your system and make final confirmation with a CS (Commercial Sample) version MCU.

4.3 Connection Diagram

Figure 4.1 shows a part of the connection diagram of the M3028BT2-CPE. This connection diagram mainly shows the interface section. The circuits not connected to the user system such as the emulator's control system are omitted. The signals not shown in Figure 4.1 connect the evaluation MCU and the user system directly. Table 4.2 shows IC electric characteristics of this product for reference purposes.

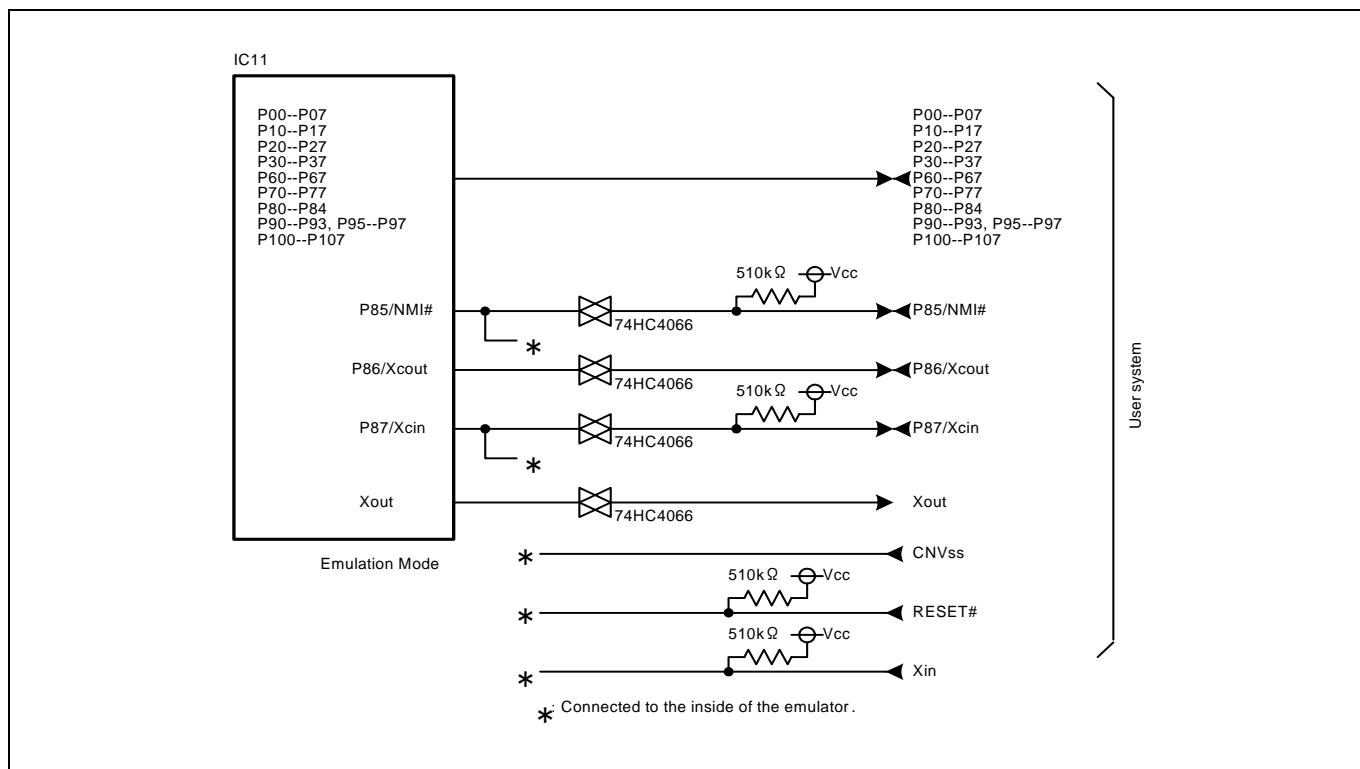

Figure 4.1 Connection diagram

Table 4.2 Electrical characteristics of the 74HC4066

Symbol	Item	Condition	Standard values			Unit
			Min.	Standard	Max.	
R _{ON}	ON resistor	VCC=4.5V	-	96	200	Ω
ΔR _{ON}	ON resistor difference	VCC=4.5V	-	10	-	
I _{OFF}	Leak current (Off)	VCC=12.0V	-	-	±1	μA
I _Z	Leak current (On, output: open)	VCC=12.0V	-	-	±1	

4.4 External Dimensions

4.4.1 External Dimensions of the Compact Emulator

Figure 4.2 shows external dimensions of the M3028BT2-CPE connected with the M30290T-PTCB.

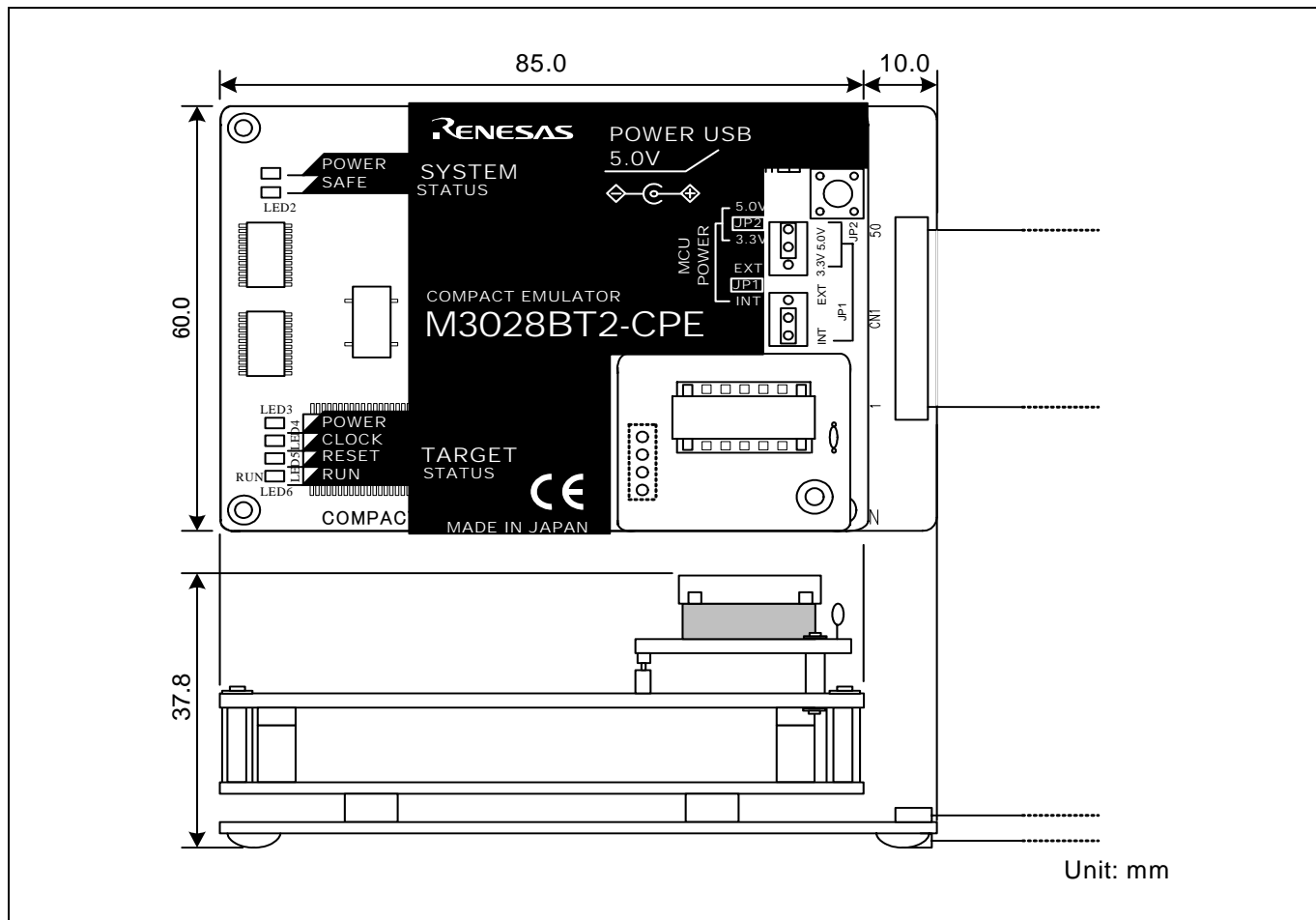

Figure 4.2 External dimensions of the compact emulator

4.4.2 External Dimensions of the Converter Board M30263T-42SSB

Figure 4.3 shows external dimensions and a sample foot pattern of the converter board M30263T-42SSB (included with the M3028BT2-CPE-1) for a 42-pin 0.8mm pitch SSOP.

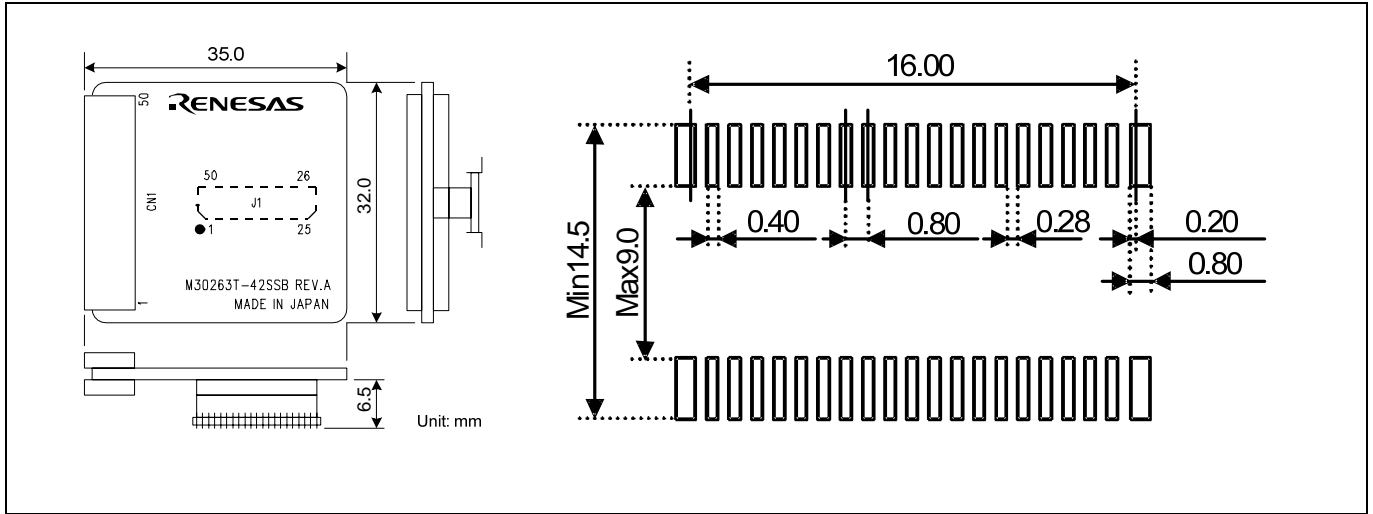

Figure 4.3 External dimensions and a sample foot pattern of the converter board M30263T-42SSB

4.4.3 External Dimensions of the Converter Board M30260T-48FPD

Figure 4.4 shows external dimensions and a sample foot pattern of the converter board M30260T-48FPD (included with the M3028BT2-CPE-2) for a 48-pin 0.5mm pitch LQFP.

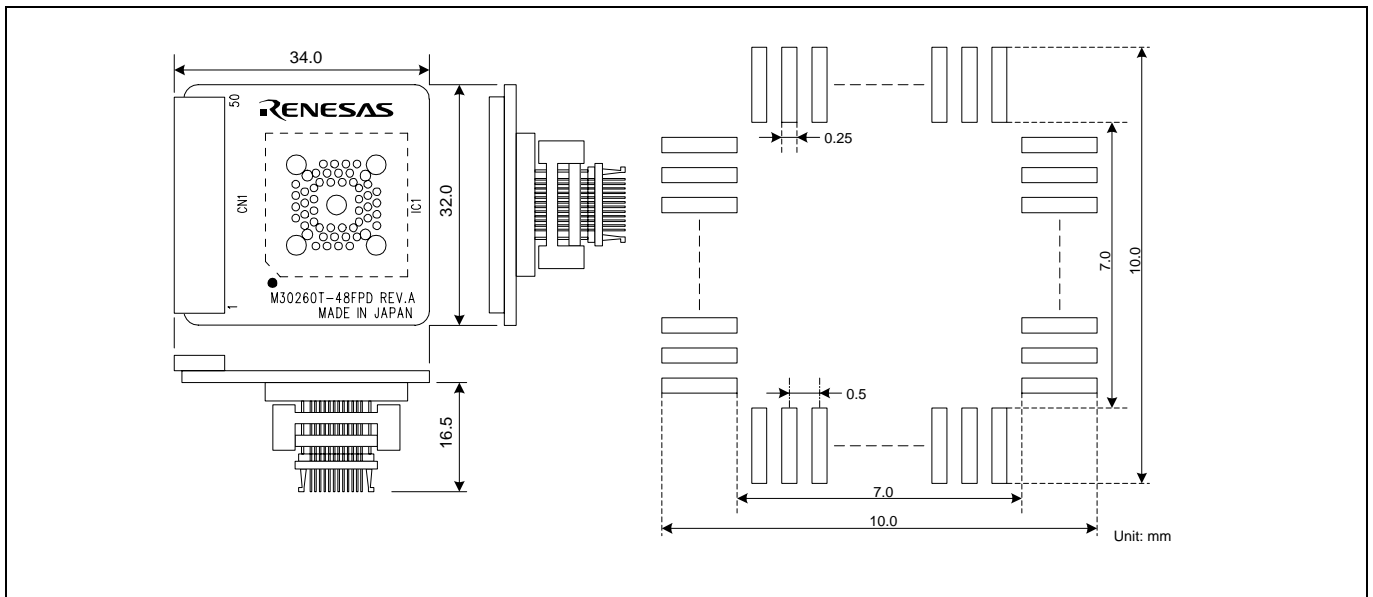

Figure 4.4 External dimensions and a sample foot pattern of the converter board M30260T-48FPD

4.4.4 External Dimensions of the Converter Board M30291T-64FPD

Figure 4.5 shows external dimensions and a sample foot pattern of the converter board M30291T-64FPD (included with the M3028BT2-CPE-3) for a 64-pin 0.5mm pitch LQFP.

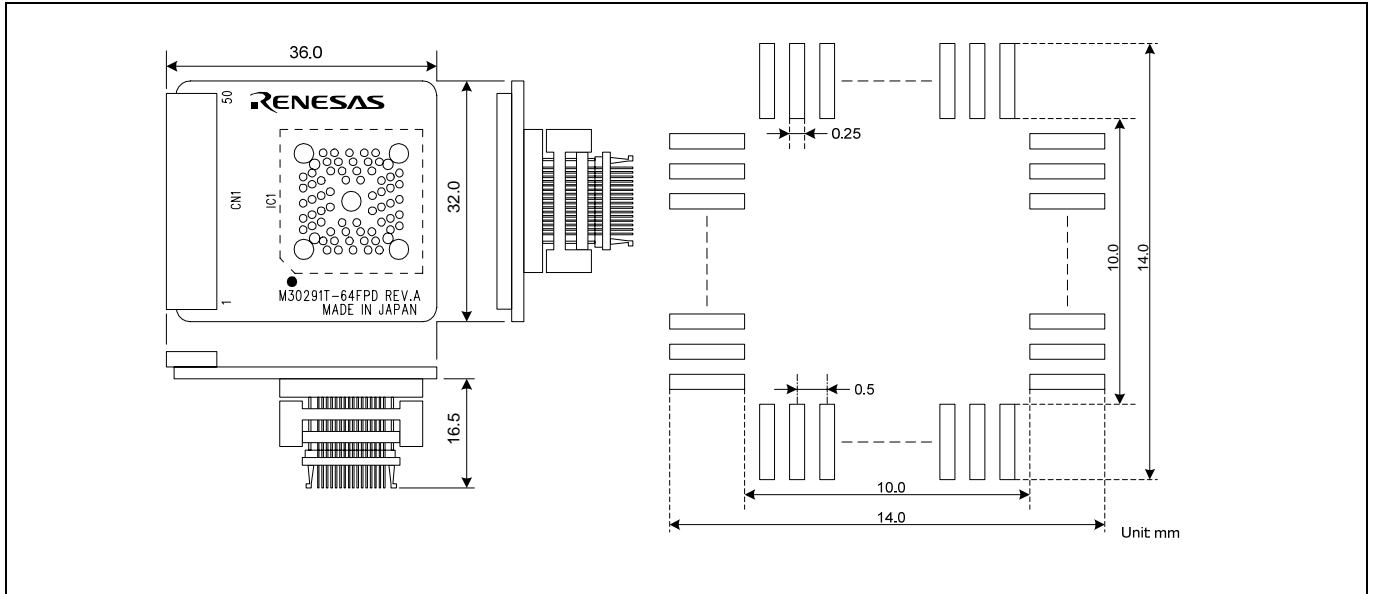

Figure 4.5 External dimensions and a sample foot pattern of the converter board M30291T-64FPD

4.4.5 External Dimensions of the Converter Board M30290T-80FPD

Figure 4.6 shows external dimensions and a sample foot pattern of the converter board M30290T-80FPD (included with the M3028BT2-CPE-4) for an 80-pin 0.5mm pitch LQFP.

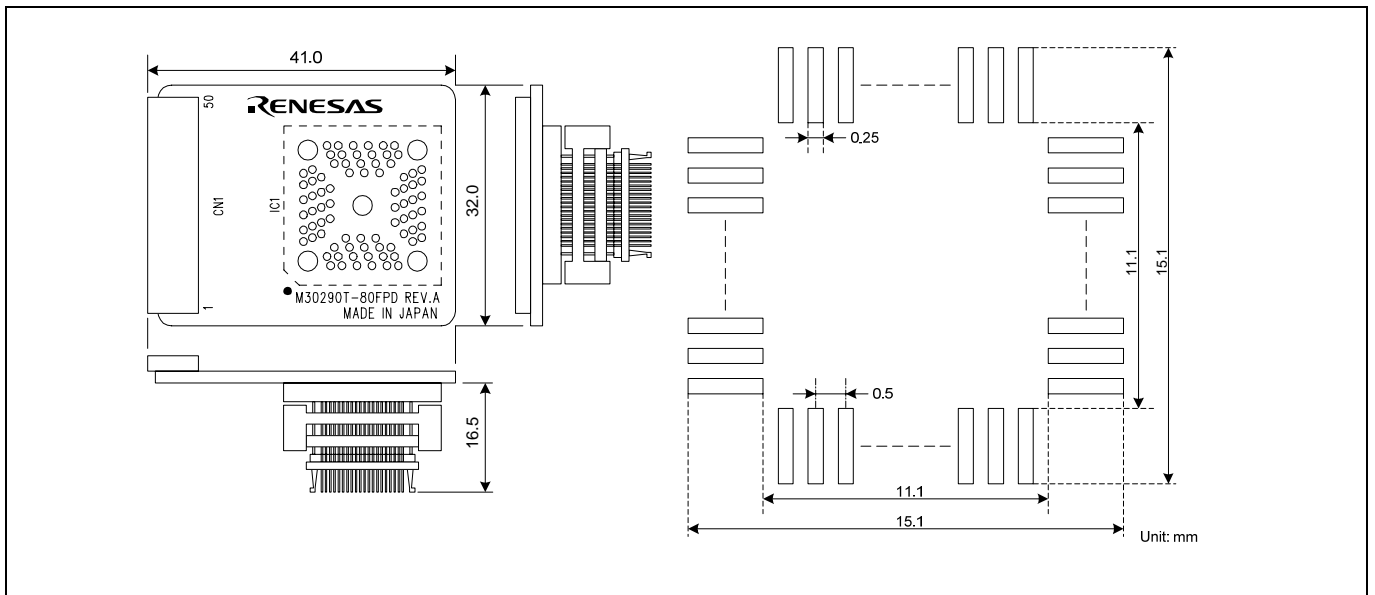

Figure 4.6 External dimensions and a sample foot pattern of the converter board M30290T-80FPD

4.4.6 External Dimensions of the Converter Board M30280T-85LGF

Figure 4.7 shows external dimensions and a sample foot pattern of the converter board M30280T-85LGF (included with the M3028BT2-CPE-5) for an 85-pin 0.65mm pitch TFLGA.

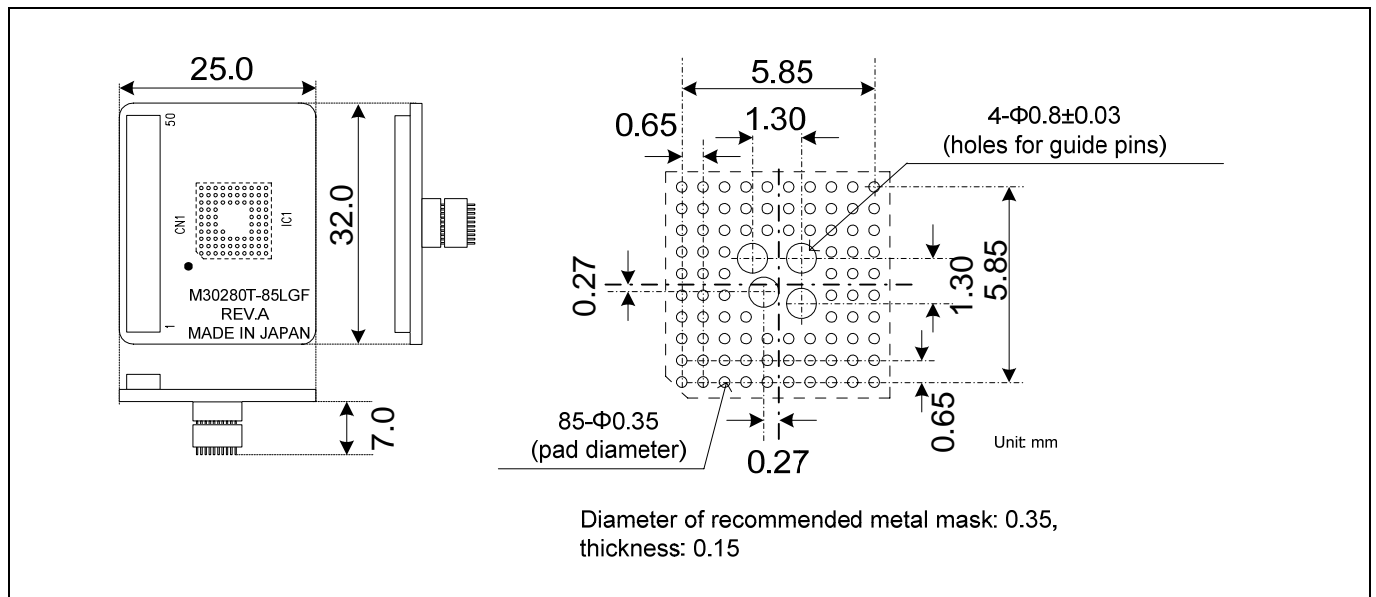

Figure 4.7 External dimensions and a sample foot pattern of the converter board M30280T-85LGF

4.5 Notes on Using This Product

Notes on using this product are listed below. When debugging the MCU using this product, be careful about the following precautions.

IMPORTANT

Note on the Version of the Emulator Debugger:

- Be sure to use this product with one of the following emulator debuggers.
 - M16C R8C Compact Emulator debugger V.1.02 Release 00 or later
 - When debugging the M16C/26A Group MCUs, an MCU file for the M16C/26A and M16C/26B (M16C26.MCU) is required.
 - When debugging the M16C/28 Group MCUs, an MCU file for the M16C/28 and M16C/28B (M16C28.MCU) is required.
 - When debugging the M16C/29 Group MCUs, an MCU file for the M16C/29 (M16C29.MCU) is required.

Notes on the Self-check:

- If the self-check does not result normally (excluding target status errors), the emulator may be damaged. Then contact your local distributor.
- Run the self-check with the user system not connected.

Note on Quitting the Emulator Debugger:

- To restart the emulator debugger, always shut power to the emulator module off once and then on again.

Notes on the User System (Power Supply, Order of Powering On):

- When the user system is connected, be sure to set the JP1 of the emulator to "EXT".
 - This emulator cannot supply the power to the user system. Therefore design your system so that the user system is powered separately.
 - This emulator consumes max. 500mA of electric current from the user system.
 - The voltage of the user system should be as follows.

$$2.7\text{ V} \leq \text{VCC} \leq 5.5\text{ V}$$
 - Do not change the voltage of the user system after turning on the power.
 - Before powering on your emulator system, check that the host machine, the emulator, the converter board and user system are all connected correctly. Next, turn on the power to each equipment following the procedure below.
 - (1) Turn ON/OFF the user system and the emulator as simultaneously as possible.
 - (2) When the emulator debugger starts up, check the target status LEDs on the emulator to see if this product is ready to operate.
 - Is the power supplied? Check that target status LED (POWER) is ON.*1
 - Is the clock supplied? Check that target status LED (CLOCK) is ON.
- *1 When the user system is not connected the target status LED (POWER) does not light.

IMPORTANT

Note on Clock Supply to the MCU:

- A clock supplied to the evaluation MCU is selected by the Emulator tab in the Init dialog box of the emulator debugger.
 - (1) When "Internal" is selected:

A clock generated by the oscillator circuit board in the M3028BT2-CPE is supplied. It is continually supplied regardless of the status of the user system clock and that of the user program execution.
 - (2) When "External" is selected:

A clock generated by the oscillator in the user system is supplied. It depends on the status of the oscillation (on/off) of the user system.

Note on Stop and Wait Modes:

- Do not single step an instruction shifting to stop or wait mode. It may cause communications errors.

Note on Display of MCU Status:

- "MCU status" you can refer to in the MCU tab of the MCU Setting dialog box of the emulator debugger shows pin levels of the user system. Make sure that proper pin levels are specified according to the mode you use. When this product is used with connecting to the user system, be sure to set as follow:
CNVss: Low

Note on Breaks:

- The following three breaks can be selected in the emulator debugger.
 - (1) Address-match break
This is a debugging function which breaks a program, using the address-match interrupt function of the MCU, immediately before the system executes an instruction at a specified address. The instruction at the preset address will not be executed.
 - (2) Software break
This is a debugging function which generates a BRK interruption by changing an instruction at a specified address to a BRK instruction (00h) to break a program immediately before the system executes an instruction at a specified address. The instruction at the preset address will not be executed.
 - (3) Hardware break
This is a debugging function which breaks a program by setting the detection of an execution of an instruction at a specified address as a break event. The program will break after the instruction at the specified address is executed.

Notes on Address-Match Breaks:

- As the processing speed of setting and canceling address-match breaks is relatively fast, you can save the times of writing into the internal flash ROM of an MCU. Therefore, address-match breaks precede the other breaks when setting breakpoints in the internal flash ROM area of an MCU.
- Address-match breaks can be set up to six points.
- Address-match breaks can be set or canceled even when the user program is being executed.

IMPORTANT

Notes on Address-Match Interrupts:

- When you use the address-match interrupt function in a user program, uncheck "Enable the Address Match Interrupt Break Function" in the MCU tab of the Init dialog box of the emulator debugger. Thus, normal software breaks are used for the internal RAM and ROM areas of an MCU.
- Do not set a software break at an address where an address-match interrupt occurs. Otherwise, a user program may be run out of control. Set a software or hardware break in the top address in address-match interrupt processing.
- When you single step an address where an address-match interrupt occurs, the program stops after executing the first instruction after returning from address-match interrupt processing.

Notes on Software Breaks:

- Software breaks change the instruction at a specified address to a BRK (00h). Therefore, take note that when you reference the result of a trace in bus mode, "00h" is displayed.
- As the BRK instruction is used for the emulator, do not use it in a user program.
- You can neither set nor cancel a software breakpoint in the internal ROM area of an MCU during user program execution, while you can set or cancel it in the internal RAM area of an MCU.

Note on the Watchdog Function:

- If the reset circuit of the user system has a watchdog timer, disable it when using the emulator.

Note on Protect Register:

- The protect is not canceled when bit 2 of protect register PRCR (PRC2), which enables writing into the port P9 direction register and the SI/Oi control register, is changed with the below procedure.
 - (1) Step execution of an instruction setting PRC2 to "1"
 - (2) Setting a break point between an instruction setting PRC2 to "1" and a point where the port P9 direction register or the SI/Oi control register is set
 - (3) Setting PRC2 to "1" by the memory window or script window

Note on Internal Flash ROM of the MCU:

- Because the number of write/erase cycles of the internal flash ROM of the MCU is limited, it must be replaced at the end of its service-life. If the following errors occur frequently when downloading a program, replace the MCU board.
 - (1) Flash ROM erase error occurred ERROR (16258)
 - (2) Flash ROM verify error occurred ERROR (16259)To purchase products for replacement, contact your local distributor.

IMPORTANT

Notes on Debugging in CPU Rewrite Mode:

- When you debug M16C/Tiny Series MCUs in CPU rewrite mode, do not change the block 0 area (FF000h--FFFFFh) of the flash ROM. Otherwise, the emulator will be uncontrollable.
- If you check "Debug the program using CPU Rewrite Mode" in the MCU tab of the Init dialog box of the emulator debugger, you cannot use the following functions.
 - (1) Setting software breakpoints in an internal ROM area
 - (2) Executing COME in an internal ROM area
- Do not stop the program in CPU rewrite mode or erase suspend mode. And do not single-step the instructions shifting to the CPU rewrite mode or erase suspend mode. The emulator will go out of control in CPU rewrite mode or erase suspend mode.
- Do not stop the program in CPU rewrite mode. And do not single-step the instructions shifting to the CPU rewrite mode. The emulator will go out of control in CPU rewrite mode.
- As the following interrupt vectors are used by the emulator system, the read data is different from expected value.
 - (1) BRK instruction (FFFE4h--FFFE7h)
 - (2) Address match (FFFE8h--FFFEb)
 - (3) Single-step (FFFECh--FFFEFh)
 - (4) DBC (FFFF4h--FFFF7h)

Notes on CE Declaration of Conformity:

- Please use this product with care as described below.
 - * Electrostatic Discharge Precautions must be taken when handling the product.
 - * Must not be used within 30 meters of a domestic radio or television receiver.
 - * For correct operation of this product, it is recommended that Mobile phones are not used within 10 meters of this product system.
 - * This product should be powered down when not in use.
 - * Use the power supply which complies with CE marking requirements.
- This product generates, uses, and can radiate radio frequency energy and may cause harmful interference to radio communications.
- If this product causes harmful interference to radio or television reception, which can be determined by turning this product off or on, you are encouraged to try to correct the interference by one or more of the following methods;
 - * Ensure attached cables do not lie across the probe board and converter board.
 - * Reorient the receiving antenna.
 - * Increase the distance between the product and the receiver.
 - * Connect the product into an outlet on a circuit different from that to which the receiver is connected.
 - * Consult the dealer or experienced radio/TV technician for help.
- Attach the ferrite core included with this product close to the DC plug of the power cable. Without the ferrite core it may cause interference.
The power cable should be wound around the ferrite core as shown in the figure, and close the ferrite core until it clicks.

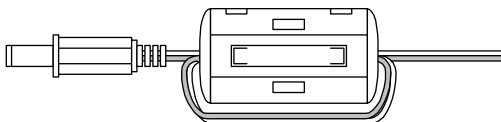

5. Troubleshooting

This chapter describes how to troubleshoot when this product does not work properly.

5.1 Flowchart to Remedy the Troubles

Figure 5.1 shows the flowchart to remedy the troubles from when power to the emulator is activated until the emulator debugger starts up. Check this while the user system is disconnected. For the latest FAQs visit the Renesas Tools Homepage.

<http://www.renesas.com/tools>

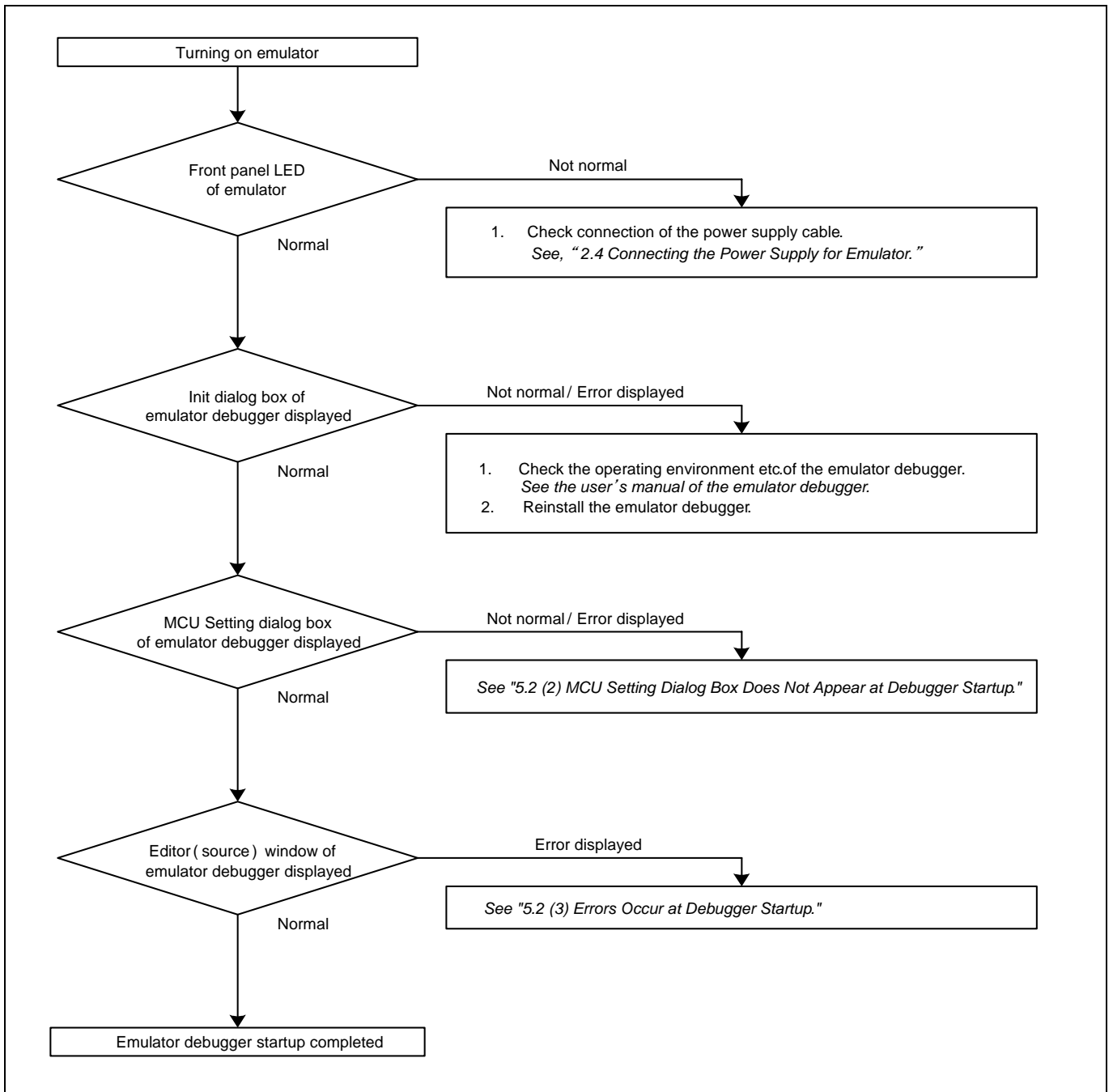

Figure 5.1 Flowchart to remedy the troubles

5.2 When the Emulator Debugger Does Not Start Up Properly

(1) When the LEDs of the M3028BT2-CPE Do Not Display Normally

Table 5.1 Errors LEDs show and their checkpoints

Error	Connection to the user system	Checkpoint
LEDs do not light up.	-	Check that the power cable is connected. <i>See "2.4 Connecting a Power Supply" (page 23).</i>
Target Status POWER LED does not light up.	Connected	Check that power is properly supplied to the user system and that the user system is properly grounded.
Target Status CLOCK LED does not light up.	Not connected	(1) Check that both the main and sub clocks of the emulator debugger are not set to "EXT". <i>See the CLK command of the emulator debugger.</i> (2) Check that the oscillator circuit board is properly installed in the emulator and is oscillating. <i>See "2.9.2 Selecting Clock Supply" (page 38).</i>
	Connected	When the clock is supplied from an external oscillator, check that the oscillator circuit in the user system is oscillating properly. <i>See "2.9.2 Selecting Clock Supply" (page 38).</i>
Target Status RESET LED does not go out.	Connected	Check that the reset pin of the user system is at "H" level.

(2) MCU Setting Dialog Box Does Not Appear at Debugger Startup

Table 5.2 Checkpoints of errors at debugger startup

Error	Checkpoint
Communication error occurred. Data was not sent to the target.	Check that the USB cable is connected properly. <i>See "2.5 Connecting the Host Machine" (page 24).</i>
Not compact emulator.	Check that an emulator other than the compact emulator (such as PC4701, PC7501) is not connected.
Target MCU is in the reset state.	(1) Check that the reset pin of the user system is at "H" level. (2) Check that the reset pin of the user system has changed from Low to High level.
Target MCU cannot be reset.	(1) Check that pin NMI# is held High. (2) If the reset circuit of the user system has a watchdog timer, disable the timer. (3) Check that power is properly supplied to the user system and that the user system is properly grounded.
Target is in "HOLD" state.	The MCU is either in stop mode or wait mode. Either reset the MCU or cancel the mode with an interrupt. <i>See MCU specifications.</i>
Target clock is stopped.	When the clock is supplied from the user system, check that the oscillator circuit in the user system is oscillating properly. <i>See "2.9.2 Selecting Clock Supply" (page 38).</i>
Target MCU is not receiving power.	Check that power is properly supplied to the user system and that the user system is properly grounded.

(3) Errors Occur at Debugger Startup

Table 5.3 Checkpoints of errors at debugger startup

Error	Checkpoint
Target MCU is uncontrollable.	<ol style="list-style-type: none"><li data-bbox="651 322 1468 383">(1) Check that the NQPACK etc. mounted on the user system is soldered properly.<li data-bbox="651 389 1468 421">(2) Check that the connector is installed properly to the user system.<li data-bbox="651 427 1468 459">(3) Check that pin CNVSS is held Low.

5.3 How to Request for Support

After checking the items in "5 Troubleshooting", fill in the text file which is downloaded from the following page, then send the information to your local distributor.

<http://tool-support.renesas.com/eng/toolnews/registration/support.txt>

For prompt response, please specify the following information:

(1) Operating environment

- Operating voltage: _____ [V]
- Operating frequency: _____ [MHz]
- Clock supply to the MCU: Internal oscillator/External oscillator

(2) Condition

- The emulator debugger starts up/does not start up
- The error is detected/not detected in the self-check
- Frequency of errors: always/frequency (_____)

(3) Problem

6. Maintenance and Guarantee

This chapter describes how to maintenance, repair provisions and how to request for repair.

6.1 User Registration

When you purchase our product, be sure register as a user. For user registration, refer to "User Registration" (page 12) of this user's manual.

6.2 Maintenance

- (1) If dust or dirt collects on any equipment of your emulation system, wipe it off with a dry soft cloth. Do not use thinner or other solvents because these chemicals can cause the equipment's surface coating to separate.
- (2) When you do not use this product for a long period, for safety purposes, disconnect the power cable from the power supply.

6.3 Guarantee

If your product becomes faulty within one year after its purchase while being used under good conditions by observing "IMPORTANT" and "Precautions for Safety" described in this user's manual, we will repair or replace your faulty product free of charge. Note, however, that if your product's fault is raised by any one of the following causes, we will repair it or replace it with new one with extra-charge:

- Misuse, abuse, or use under extraordinary conditions
- Unauthorized repair, remodeling, maintenance, and so on
- Inadequate user's system or misuse of it
- Fires, earthquakes, and other unexpected disasters

In the above cases, contact your local distributor. If your product is being leased, consult the leasing company or the owner.

6.4 Repair Provisions

(1) Repair with extra-charge

The products elapsed more than one year after purchase can be repaired with extra-charge.

(2) Replacement with extra-charge

If your product's fault falls in any of the following categories, the fault will be corrected by replacing the entire product instead of repair, or you will be advised to purchase new one, depending on the severity of the fault.

- Faulty or broken mechanical portions
- Flaw, separation, or rust in coated or plated portions
- Flaw or cracks in plastic portions
- Faults or breakage caused by improper use or unauthorized repair or modification
- Heavily damaged electric circuits due to overvoltage, overcurrent or shorting of power supply
- Cracks in the printed circuit board or burnt-down patterns
- Wide range of faults that makes replacement less expensive than repair
- Unlocatable or unidentified faults

(3) Expiration of the repair period

When a period of one year elapses after the model was dropped from production, repairing products of the model may become impossible.

(4) Transportation fees at sending your product for repair

Please send your product to us for repair at your expense.

6.5 How to Make Request for Repair

If your product is found faulty, fill in a Repair Request Sheet downloadable from the following URL. And email the sheet and send the product to your local distributor.

<http://www.renesas.com/repair>

CAUTION

Note on Transporting the Product:

- When sending your product for repair, use the packing box and cushion material supplied with this product when delivered to you and specify handling caution for it to be handled as precision equipment. If packing of your product is not complete, it may be damaged during transportation. When you pack your product in a bag, make sure to use conductive polyvinyl supplied with this product (usually a blue bag). When you use other bags, they may cause a trouble on your product because of static electricity.

Compact Emulator for M16C/Tiny Series
M3028BT2-CPE User's Manual

Publication Date: Jul. 22, 2009 Rev.3.00

Published by: Sales Strategic Planning Div.
 Renesas Technology Corp.

Edited by: Microcomputer Tool Development Department
 Renesas Solutions Corp.

M3028BT2-CPE User's Manual



Renesas Electronics Corporation

1753, Shimonumabe, Nakahara-ku, Kawasaki-shi, Kanagawa 211-8668 Japan

REJ10J1457-0300(T)