

To our customers,

Old Company Name in Catalogs and Other Documents

On April 1st, 2010, NEC Electronics Corporation merged with Renesas Technology Corporation, and Renesas Electronics Corporation took over all the business of both companies. Therefore, although the old company name remains in this document, it is a valid Renesas Electronics document. We appreciate your understanding.

Renesas Electronics website: <http://www.renesas.com>

April 1st, 2010
Renesas Electronics Corporation

Issued by: Renesas Electronics Corporation (<http://www.renesas.com>)

Send any inquiries to <http://www.renesas.com/inquiry>.

Notice

1. All information included in this document is current as of the date this document is issued. Such information, however, is subject to change without any prior notice. Before purchasing or using any Renesas Electronics products listed herein, please confirm the latest product information with a Renesas Electronics sales office. Also, please pay regular and careful attention to additional and different information to be disclosed by Renesas Electronics such as that disclosed through our website.
2. Renesas Electronics does not assume any liability for infringement of patents, copyrights, or other intellectual property rights of third parties by or arising from the use of Renesas Electronics products or technical information described in this document. No license, express, implied or otherwise, is granted hereby under any patents, copyrights or other intellectual property rights of Renesas Electronics or others.
3. You should not alter, modify, copy, or otherwise misappropriate any Renesas Electronics product, whether in whole or in part.
4. Descriptions of circuits, software and other related information in this document are provided only to illustrate the operation of semiconductor products and application examples. You are fully responsible for the incorporation of these circuits, software, and information in the design of your equipment. Renesas Electronics assumes no responsibility for any losses incurred by you or third parties arising from the use of these circuits, software, or information.
5. When exporting the products or technology described in this document, you should comply with the applicable export control laws and regulations and follow the procedures required by such laws and regulations. You should not use Renesas Electronics products or the technology described in this document for any purpose relating to military applications or use by the military, including but not limited to the development of weapons of mass destruction. Renesas Electronics products and technology may not be used for or incorporated into any products or systems whose manufacture, use, or sale is prohibited under any applicable domestic or foreign laws or regulations.
6. Renesas Electronics has used reasonable care in preparing the information included in this document, but Renesas Electronics does not warrant that such information is error free. Renesas Electronics assumes no liability whatsoever for any damages incurred by you resulting from errors in or omissions from the information included herein.
7. Renesas Electronics products are classified according to the following three quality grades: "Standard", "High Quality", and "Specific". The recommended applications for each Renesas Electronics product depends on the product's quality grade, as indicated below. You must check the quality grade of each Renesas Electronics product before using it in a particular application. You may not use any Renesas Electronics product for any application categorized as "Specific" without the prior written consent of Renesas Electronics. Further, you may not use any Renesas Electronics product for any application for which it is not intended without the prior written consent of Renesas Electronics. Renesas Electronics shall not be in any way liable for any damages or losses incurred by you or third parties arising from the use of any Renesas Electronics product for an application categorized as "Specific" or for which the product is not intended where you have failed to obtain the prior written consent of Renesas Electronics. The quality grade of each Renesas Electronics product is "Standard" unless otherwise expressly specified in a Renesas Electronics data sheets or data books, etc.

"Standard": Computers; office equipment; communications equipment; test and measurement equipment; audio and visual equipment; home electronic appliances; machine tools; personal electronic equipment; and industrial robots.

"High Quality": Transportation equipment (automobiles, trains, ships, etc.); traffic control systems; anti-disaster systems; anti-crime systems; safety equipment; and medical equipment not specifically designed for life support.

"Specific": Aircraft; aerospace equipment; submersible repeaters; nuclear reactor control systems; medical equipment or systems for life support (e.g. artificial life support devices or systems), surgical implantations, or healthcare intervention (e.g. excision, etc.), and any other applications or purposes that pose a direct threat to human life.

8. You should use the Renesas Electronics products described in this document within the range specified by Renesas Electronics, especially with respect to the maximum rating, operating supply voltage range, movement power voltage range, heat radiation characteristics, installation and other product characteristics. Renesas Electronics shall have no liability for malfunctions or damages arising out of the use of Renesas Electronics products beyond such specified ranges.
9. Although Renesas Electronics endeavors to improve the quality and reliability of its products, semiconductor products have specific characteristics such as the occurrence of failure at a certain rate and malfunctions under certain use conditions. Further, Renesas Electronics products are not subject to radiation resistance design. Please be sure to implement safety measures to guard them against the possibility of physical injury, and injury or damage caused by fire in the event of the failure of a Renesas Electronics product, such as safety design for hardware and software including but not limited to redundancy, fire control and malfunction prevention, appropriate treatment for aging degradation or any other appropriate measures. Because the evaluation of microcomputer software alone is very difficult, please evaluate the safety of the final products or system manufactured by you.
10. Please contact a Renesas Electronics sales office for details as to environmental matters such as the environmental compatibility of each Renesas Electronics product. Please use Renesas Electronics products in compliance with all applicable laws and regulations that regulate the inclusion or use of controlled substances, including without limitation, the EU RoHS Directive. Renesas Electronics assumes no liability for damages or losses occurring as a result of your noncompliance with applicable laws and regulations.
11. This document may not be reproduced or duplicated, in any form, in whole or in part, without prior written consent of Renesas Electronics.
12. Please contact a Renesas Electronics sales office if you have any questions regarding the information contained in this document or Renesas Electronics products, or if you have any other inquiries.

(Note 1) "Renesas Electronics" as used in this document means Renesas Electronics Corporation and also includes its majority-owned subsidiaries.

(Note 2) "Renesas Electronics product(s)" means any product developed or manufactured by or for Renesas Electronics.

H8S, H8SX Family E10A-USB Emulator

Additional Document for User's Manual
Supplementary Information on Using
the H8S/2114RF

Renesas Microcomputer Development
Environment System

H8S Family / H8S/2100 Series

E10A-USB for H8S/2114RF HS2114KCU01HE

Notes regarding these materials

1. This document is provided for reference purposes only so that Renesas customers may select the appropriate Renesas products for their use. Renesas neither makes warranties or representations with respect to the accuracy or completeness of the information contained in this document nor grants any license to any intellectual property rights or any other rights of Renesas or any third party with respect to the information in this document.
2. Renesas shall have no liability for damages or infringement of any intellectual property or other rights arising out of the use of any information in this document, including, but not limited to, product data, diagrams, charts, programs, algorithms, and application circuit examples.
3. You should not use the products or the technology described in this document for the purpose of military applications such as the development of weapons of mass destruction or for the purpose of any other military use. When exporting the products or technology described herein, you should follow the applicable export control laws and regulations, and procedures required by such laws and regulations.
4. All information included in this document such as product data, diagrams, charts, programs, algorithms, and application circuit examples, is current as of the date this document is issued. Such information, however, is subject to change without any prior notice. Before purchasing or using any Renesas products listed in this document, please confirm the latest product information with a Renesas sales office. Also, please pay regular and careful attention to additional and different information to be disclosed by Renesas such as that disclosed through our website. (<http://www.renesas.com>)
5. Renesas has used reasonable care in compiling the information included in this document, but Renesas assumes no liability whatsoever for any damages incurred as a result of errors or omissions in the information included in this document.
6. When using or otherwise relying on the information in this document, you should evaluate the information in light of the total system before deciding about the applicability of such information to the intended application. Renesas makes no representations, warranties or guaranties regarding the suitability of its products for any particular application and specifically disclaims any liability arising out of the application and use of the information in this document or Renesas products.
7. With the exception of products specified by Renesas as suitable for automobile applications, Renesas products are not designed, manufactured or tested for applications or otherwise in systems the failure or malfunction of which may cause a direct threat to human life or create a risk of human injury or which require especially high quality and reliability such as safety systems, or equipment or systems for transportation and traffic, healthcare, combustion control, aerospace and aeronautics, nuclear power, or undersea communication transmission. If you are considering the use of our products for such purposes, please contact a Renesas sales office beforehand. Renesas shall have no liability for damages arising out of the uses set forth above.
8. Notwithstanding the preceding paragraph, you should not use Renesas products for the purposes listed below:
 - (1) artificial life support devices or systems
 - (2) surgical implantations
 - (3) healthcare intervention (e.g., excision, administration of medication, etc.)
 - (4) any other purposes that pose a direct threat to human lifeRenesas shall have no liability for damages arising out of the uses set forth in the above and purchasers who elect to use Renesas products in any of the foregoing applications shall indemnify and hold harmless Renesas Technology Corp., its affiliated companies and their officers, directors, and employees against any and all damages arising out of such applications.
9. You should use the products described herein within the range specified by Renesas, especially with respect to the maximum rating, operating supply voltage range, movement power voltage range, heat radiation characteristics, installation and other product characteristics. Renesas shall have no liability for malfunctions or damages arising out of the use of Renesas products beyond such specified ranges.
10. Although Renesas endeavors to improve the quality and reliability of its products, IC products have specific characteristics such as the occurrence of failure at a certain rate and malfunctions under certain use conditions. Please be sure to implement safety measures to guard against the possibility of physical injury, and injury or damage caused by fire in the event of the failure of a Renesas product, such as safety design for hardware and software including but not limited to redundancy, fire control and malfunction prevention, appropriate treatment for aging degradation or any other applicable measures. Among others, since the evaluation of microcomputer software alone is very difficult, please evaluate the safety of the final products or system manufactured by you.
11. In case Renesas products listed in this document are detached from the products to which the Renesas products are attached or affixed, the risk of accident such as swallowing by infants and small children is very high. You should implement safety measures so that Renesas products may not be easily detached from your products. Renesas shall have no liability for damages arising out of such detachment.
12. This document may not be reproduced or duplicated, in any form, in whole or in part, without prior written approval from Renesas.
13. Please contact a Renesas sales office if you have any questions regarding the information contained in this document, Renesas semiconductor products, or if you have any other inquiries.

Contents



Section 1	Connecting the Emulator with the User System.....	1
1.1	Components of the E10A-USB Emulator.....	1
1.2	Connecting the E10A-USB Emulator with the User System.....	3
1.3	Pin Assignments of the E10A-USB Connector.....	5
1.4	Example of Emulator Connection.....	6
Section 2	Specification of the Emulator's Software.....	11
2.1	Differences between the H8S/2114RF and the Emulator.....	11
2.2	The H8S/2114RF E10A-USB Emulator Specific Functions and Notes.....	14
2.2.1	Emulator Driver Selection.....	14
2.2.2	Hardware Break Functions.....	14
2.2.3	Notes on Setting the [Breakpoint] Dialog Box.....	16
2.2.4	Note on Using the JTAG Clock (TCK).....	16
2.2.5	Trace Function.....	16

Section 1 Connecting the Emulator with the User System

1.1 Components of the E10A-USB Emulator

The H8S/2114RF E10A-USB emulator supports the H8S/2114RF (hereafter referred to as the MCU unless the description is specific to any of them). Table 1.1 lists the components of the emulator.

Table 1.1 Components of the Emulator

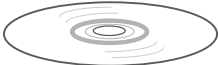
Classification	Component	Appearance	Quantity	Remarks
Hardware	Emulator box		1	HS0005KCU01H: Depth: 65.0 mm, Width: 97.0 mm, Height: 20.0 mm, Mass: 72.9 g or HS0005KCU02H ¹ : Depth: 65.0 mm, Width: 97.0 mm, Height: 20.0 mm, Mass: 73.7 g
	User system interface cable		1	14-pin type: Length: 20 cm, Mass: 33.1 g
	USB cable		1	Length: 150 cm, Mass: 50.6 g
Software	H8S/2114RF E10A-USB emulator setup program, H8S, H8SX Family E10A-USB Emulator User's Manual, Supplementary Information on Using the H8S/2114RF ² , and Test program manual for HS0005KCU01H and HS0005KCU02H		1	HS0005KCU01SR, HS0005KCU01HJ-H8S, HS0005KCU01HE-H8S, HS2114KCU01HJ, HS2114KCU01HE, HS0005TM01HJ, and HS0005TM01HE (provided on a CD-R)

- Notes: 1. When HS0005KCU02H is purchased, the 36-pin type cable is provided; however, it is not available for this MCU.
2. Additional document for the MCUs supported by the emulator is included. Check the target MCU and refer to its additional document.

1.2 Connecting the E10A-USB Emulator with the User System

Before connecting an E10A-USB emulator (hereafter referred to as emulator) with the user system, a connector must be installed in the user system so that a user system interface cable can be connected. When designing the user system, refer to an example of recommended connection between the connector and the MCU shown in this manual.

Before designing the user system, be sure to read the E10A-USB emulator user's manual and the hardware manual for related MCUs.

Connect pins 8, 9, 10, 12, 13, and 14 of the user system connector to GND firmly on the PCB. These pins are used as electrical GND and to monitor the connection of the user system connector. Note the pin arrangement of the user system connector.

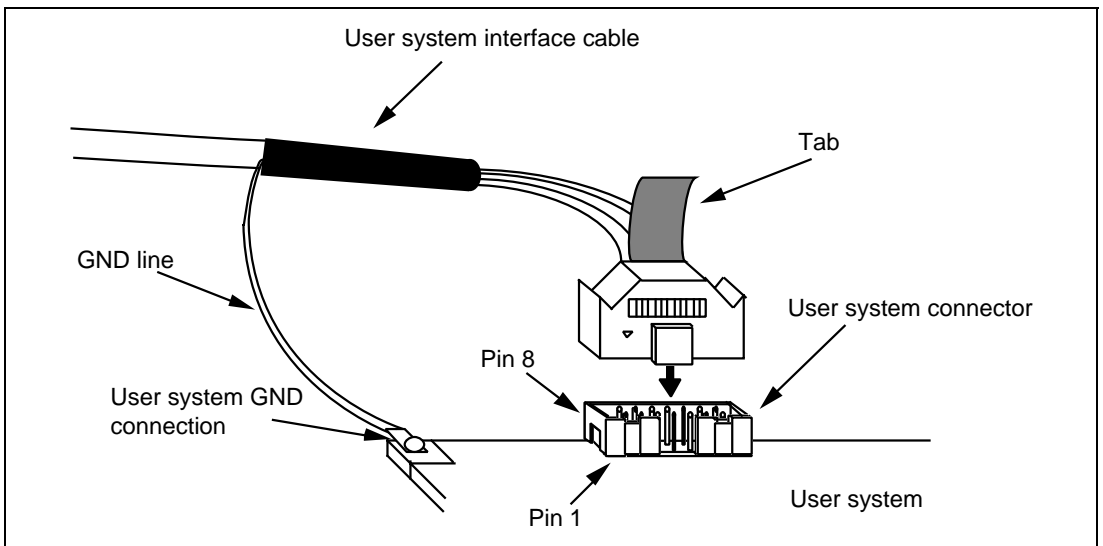

Figure 1.1 Connecting the User System Interface Cable to the User System

- Notes:
1. The pin number assignments of the 14-pin connector differ from those of the E7 emulator; however, the physical location is the same.
 2. When designing the connector layout on the user board, do not place any components within 3 mm of the connector.



WARNING

Be sure to place the GND line of the user system interface cable on the GND of the user system with a screw, etc. Failure to do so will result in a FIRE HAZARD due to an overcurrent and will damage the user system, the emulator product, and the host computer.

1.3 Pin Assignments of the E10A-USB Connector

Figure 1.2 shows the pin assignments of the user system connector.

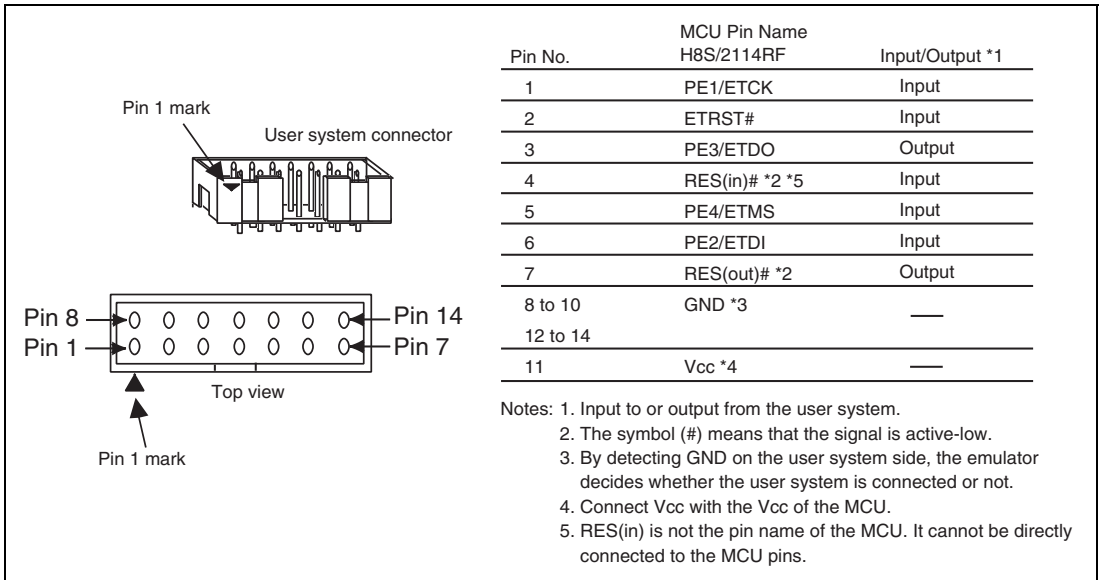

Figure 1.2 Pin Assignments of the User System Connector

1.4 Example of Emulator Connection

The figure shown below is an example of connecting the user system to the emulator.

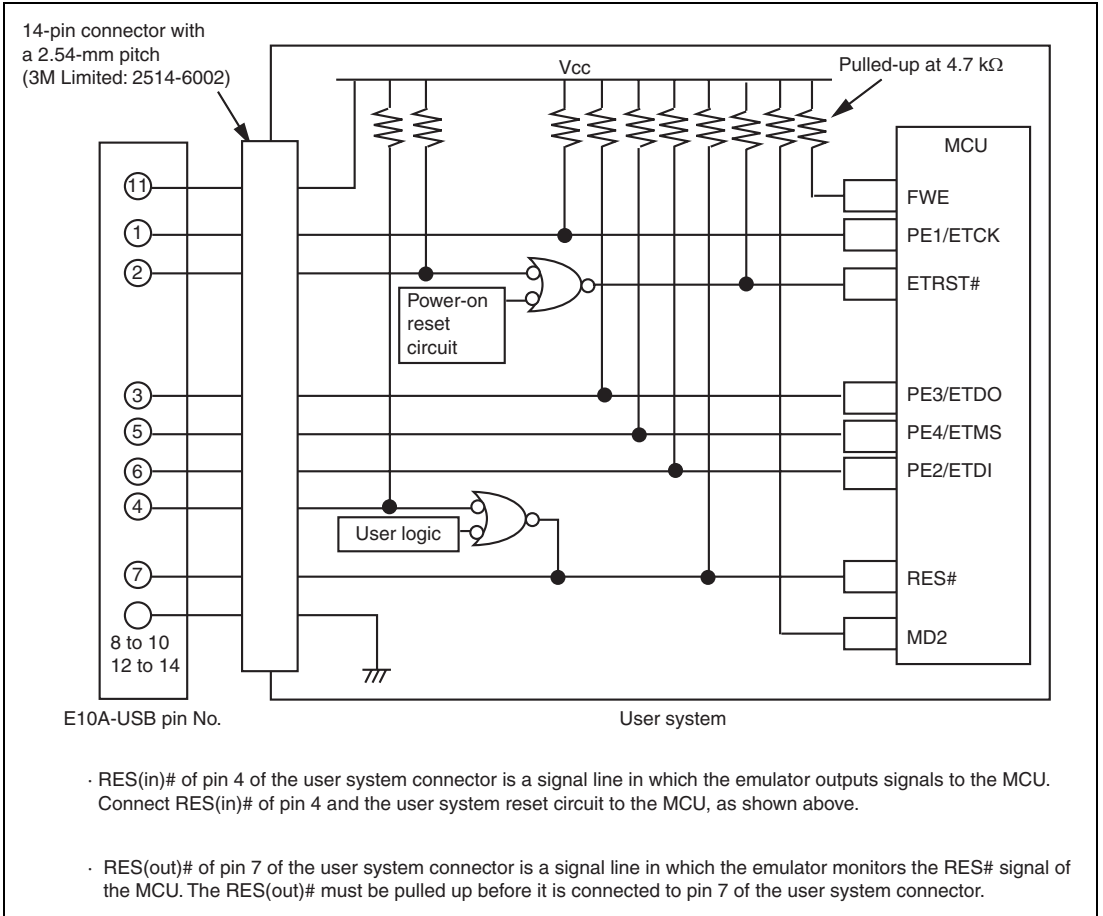

Figure 1.3 Example of Emulator Connection

Notes: 1. The emulator uses PE1/ETCK, PE2/ETDI, PE3/ETDO, and PE4/ETMS pins. Pull up the emulator and MCU pins and connect them to the user system connector.

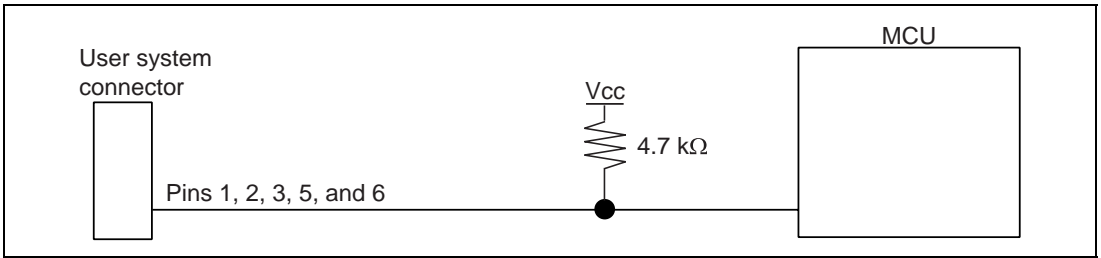

Figure 1.4 Connection of Emulator and the MCU

2. If the emulator is not connected to the user system, ground pin MD2 of the MCU, and when the emulator is connected to the user system, pull up pin MD2.

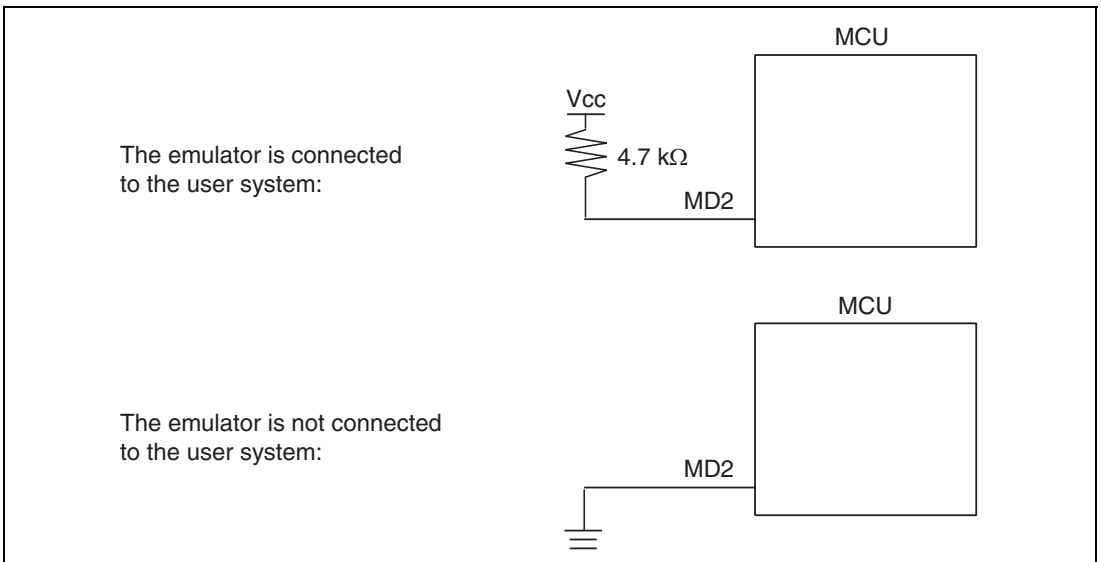

Figure 1.5 Emulator and Pin MD2

- RES(in)# of pin 4 of the user system connector is a signal line in which the emulator outputs signals to the MCU. RES(in)# of pin 4 and the user logic reset circuit must be connected to the MCU, as shown in figure 1.6. RES(out)# of pin 7 of the user system connector is a signal line in which the emulator monitors pin RES# of the MCU. The RES# must be pulled up before it is connected to pin 7 of the user system connector.

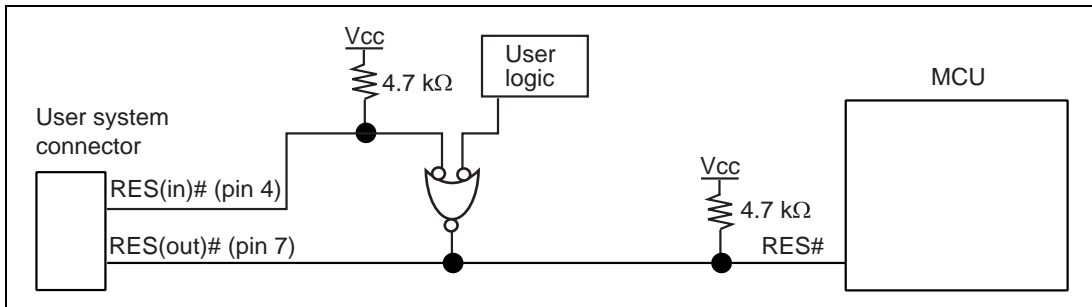

Figure 1.6 Connection of Pin RES#

- Pin FWE in the H8S/2114RF must be pulled up when connecting with the emulator.

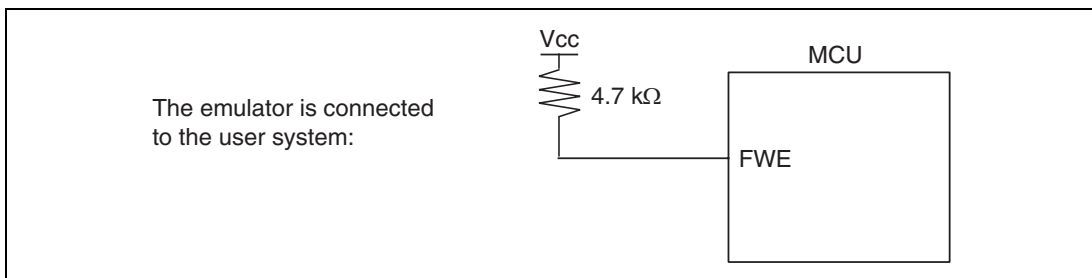

Figure 1.7 Connection of Pin FWE

- Pin ETRST# must be connected as shown in figure 1.8.

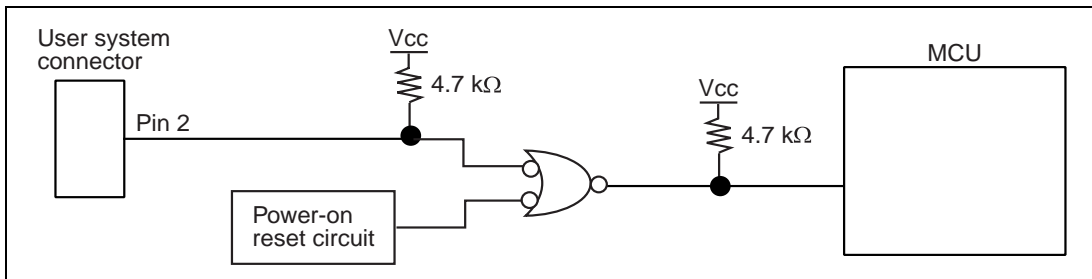

Figure 1.8 Connection of Pin ETRST#

6. Ground pins 8, 9, 10, 12, 13, and 14 of the user system connector.
7. Connect Vcc, pin 11 of the user system connector, to the power supply (Vcc) in the user system. The input voltage, Vcc, is within the range of guaranteed operation of the microcomputer.
8. When the emulator is used, the pin functions listed below are not available.

Table 1.2 Pin Functions Not Available

H8S/2114RF

PE1 to PE4

Section 2 Specification of the Emulator's Software

2.1 Differences between the H8S/2114RF and the Emulator

1. When the emulator system is initiated, it initializes the general registers and part of the control registers as shown in table 2.1. The initial value of the MCU is undefined. When the emulator is initiated from the workspace, a value to be entered is saved in a session.

Table 2.1 Register Initial Values at Emulator Power-On

Register	Initial Value
PC	Reset vector value in the vector address table
ER0 to ER6	H'0
ER7 (SP)	H'10
CCR	1 for I mask, and others undefined
EXR	H'7F

2. System Control Register

In the emulator, the internal I/O registers can be accessed from the [IO] window. However, be careful when accessing the system control register. The emulator saves the register value of the system control register at a break and returns the value when the user program is executed. Since this is done during a break, do not rewrite the system control register in the [IO] window.

3. Memory Access during Emulation

If the memory contents are referenced or modified during emulation, realtime emulation cannot be performed because the user program is temporarily halted.

4. The emulator communicates with the MCU by using the PE1/ETCK, PE2/ETDI, PE3/ETDO, and PE4/ETMS pins. These pins cannot be used.

5. The power consumed by the MCU can reach several mA. This is because the user power supply drives one IC to make the communication signal level match the user-system power-supply voltage.

6. Do not use an MCU that has been used for debugging.

If the flash memory is rewritten many times, and the MCU is left for a few days, data may be lost due to retention problems.

If the flash memory is rewritten many times, the data will not be erased. If an error message is displayed, exchange the MCU for a new one.

7. The H8S/2114RF E10A-USB emulator supports the normal and advanced modes. When the [IO] window is displayed after activating the emulator, register addresses for those modes are displayed. Use the address suitable for the user's environment.
8. Sum Data Displayed in the Writing Flash memory Mode
Sum data, which is displayed in the 'Writing Flash memory' mode, is a value that data in the whole ROM areas has been added by bytes.
9. Note on Executing the User Program
The set value is rewritten since the emulator uses flash memory registers during programming (Go, Step In, Step Out, or Step Over) of the flash memory.
10. MCU Operating Mode
The emulator supports mode 6 (16-Mbyte advanced mode) and mode 7 (64-kbyte normal mode). Use mode 6 and mode 7 for emulation in mode 2 and mode 3, respectively.
11. Programming Flash Memory during Debugging
The flash memory is programmed in the following functions because they use breakpoints:
 - When executing [Go to cursor]
 - When stepping over the subroutine
 - When executing the subroutine at step-out operation
12. Loading Sessions
Information in [JTAG clock] of the [Configuration] dialog box cannot be saved by sessions. Thus the TCK value becomes the initial value when loading sessions.
— When HS0005KCU01H or HS0005KCU02H is used: TCK = 2.5 MHz
13. Note on Using the Watchdog Timer (WDT)
If a reset occurs by an overflow of the WDT during user program halting, the emulator will not operate correctly. Do not use the reset function by the overflow of the WDT.

14. Value Set in the [System Clock] Dialog Box when Connecting the Emulator

Input the frequency of the oscillator in use in the [System Clock] dialog box (this also applies when the MCU is multiplied by the PLL circuit).

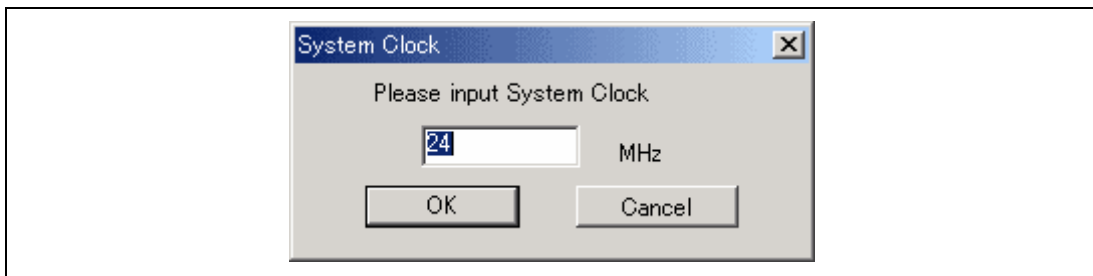

Figure 2.1 [System Clock] Dialog Box

15. Emulation on Programming or Erasing the Internal Flash Memory

A break cannot be generated while the program for programming or erasing the internal flash memory is being called. Note that the following processing also cannot be performed:

- Execution of the [STOP] button
- Auto-update of the watch function and use of the tool-chip watch function
- Memory operation during executing emulation

2.2 The H8S/2114RF E10A-USB Emulator Specific Functions and Notes

- Notes:
1. Do not use an MCU that has been used for debugging.
 2. If the flash memory is rewritten many times, and the emulator is left for a few days, data may be lost due to retention problems.
 3. If the flash memory is rewritten many times, the data will not be erased. If an error message is displayed, exchange the MCU for a new one.

2.2.1 Emulator Driver Selection

Table 2.2 shows drivers which can be selected in the [Driver Details] dialog box.

Table 2.2 Type Name and Driver

Type Name	Driver
HS0005KCU01H, HS0005KCU02H	Renesas E-Series USB Driver

2.2.2 Hardware Break Functions

Hardware Break Conditions: In the H8S/2114RF E10A-USB emulator, eight break conditions (Break Condition 1,2,3,4,5,6,7,8) can be set. Table 2.3 lists the items that can be specified.

Table 2.3 Hardware Break Condition Specification Items

Items	Description
Address bus condition	Breaks when the MCU address bus value matches the specified value.
Data bus condition	Breaks when the MCU data bus value matches the specified value. High or low byte or word can be specified as the access data size.
Read or write condition	Breaks in the read or write cycle.
Trace acquisition condition	Acquires trace information based on Break Condition 1.*

Note: Refer to section 2.2.5 (3), Setting a Break Condition for Tracing.

Table 2.4 lists the combinations of conditions that can be set in the [Break condition] dialog box.

Table 2.4 Conditions Set in [Break condition] Dialog Box

Dialog Box	Condition		
	Address Bus Condition	Data Condition	Read or Write Condition
[Break condition 1]	O	O	O
[Break condition 2]	O	O	O
[Break condition 3]	O	X	O
[Break condition 4]	O	X	O
[Break condition 5]	O	X	O
[Break condition 6]	O	X	O
[Break condition 7]	O	X	O
[Break condition 8]	O	X	O

Note: O: Can be set by checking the radio button in the dialog box.

Table 2.5 lists the combinations of conditions that can be set by the BREAKCONDITION_SET command.

Table 2.5 Conditions Set by BREAKCONDITION_SET Command

Channel	Condition		
	Address Bus Condition (<addropt> option)	Data Condition (<dataopt> option)	Read or Write Condition (<r/wopt> option)
Break condition 1	O	O	O
Break condition 2	O	O	O
Break condition 3	O	X	O
Break condition 4	O	X	O
Break condition 5	O	X	O
Break condition 6	O	X	O
Break condition 7	O	X	O
Break condition 8	O	X	O

Note: O: Can be set by the BREAKCONDITION_SET command.

Notes on Setting the Break Condition:

1. When [Step In], [Step Over], or [Step Out] is selected, the settings of Break Condition are disabled.
2. The settings of Break Condition are disabled when an instruction to which a BREAKPOINT has been set is executed.
3. When step over function is used, the settings of BREAKPOINT and Break Condition are disabled.

2.2.3 Notes on Setting the [Breakpoint] Dialog Box

1. When an odd address is set, the address is rounded down to an even address.
2. A BREAKPOINT is accomplished by replacing instructions. Accordingly, it can be set only to the flash memory or the RAM area. A BREAKPOINT cannot be set to the following addresses:
 - An area other than flash memory or RAM
 - An area occupied by the emulator program
 - An instruction in which Break Condition is satisfied
3. During step execution, a BREAKPOINT is disabled.
4. A condition set at Break Condition is disabled immediately after starting execution when an instruction at a BREAKPOINT is executed. A break does not occur even if a condition of Break Condition is satisfied immediately after starting the execution.
5. When execution resumes from the breakpoint address after the program execution stops at the BREAKPOINT, single-step execution is performed at the address before execution resumes. Therefore, realtime operation cannot be performed.
6. Settings of BREAKPOINT and Break Condition are invalid while the STEP OVER function is being used.

2.2.4 Note on Using the JTAG Clock (TCK)

When the JTAG clock (TCK) is changed, set the frequency to lower than that of the system clock.

2.2.5 Trace Function

The emulator uses the branch-instruction trace and bus trace functions in the MCU, and acquires a trace by operating the user program in realtime. The branch-instruction trace function displays the four-channel branch-source address, the mnemonic, and the operand. The bus trace function displays and searches the information on the 512-step address bus, data bus, memory access,

interrupt, and bus cycle, the mnemonic, and the operand. The acquisition conditions can also be set.

(1) Setting Trace Acquisition

The acquisition condition on the trace information is set.

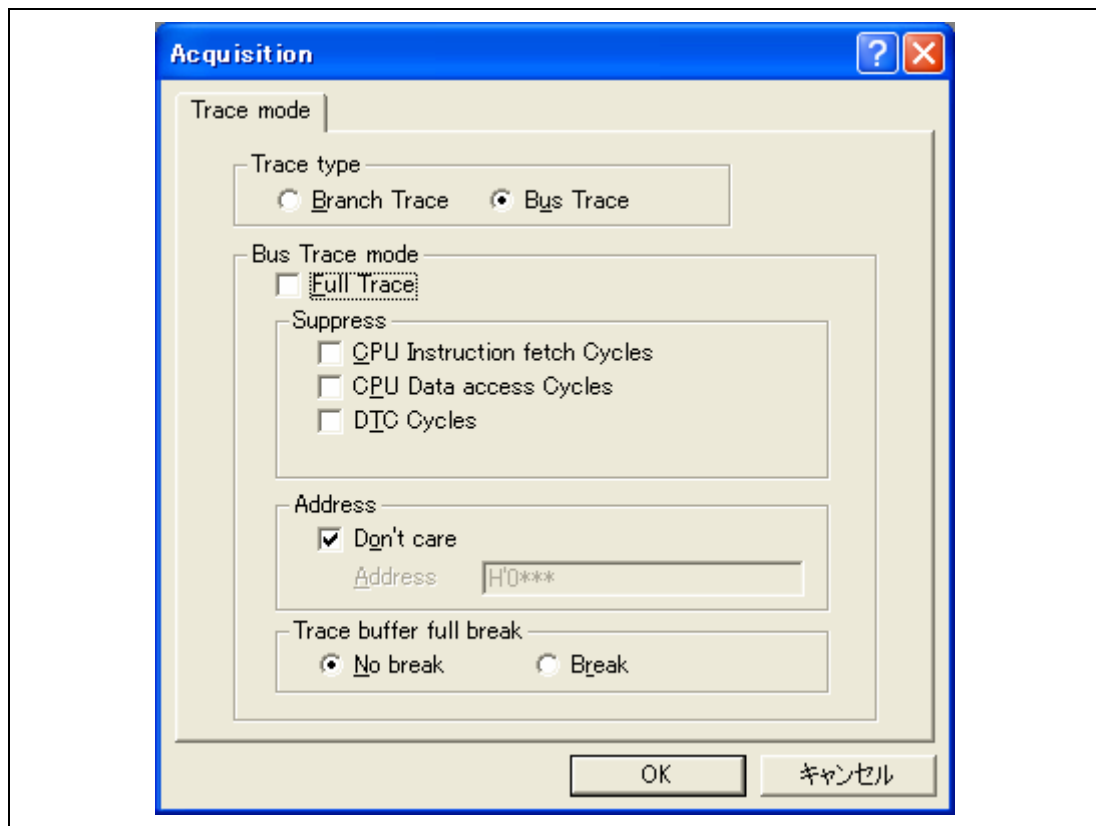

Figure 2.2 [Trace mode] Page

Table 2.6 Setting Trace Acquisition

Acquisition Condition	Description
Trace type	<p>Sets the trace information for acquisition and display.</p> <p>Branch trace: Acquires and displays the branch-instruction trace information.</p> <p>Bus trace: Acquires and displays the bus trace information.</p>
Bus Trace mode	<p>Sets the trace acquisition condition when Bus Trace is selected as Trace type. This is not set when Branch Trace is selected.</p> <ul style="list-style-type: none">• [Full Trace] check box Indicates that all cycles are acquired.• [Suppress] group box Sets a cycle to suppress acquisition. CPU Instruction fetch Cycles: Suppresses acquiring the CPU-instruction fetch cycle. CPU Data access Cycles: Suppresses acquiring the CPU-data access cycle. DTC Cycles: Suppresses acquiring the DTC cycle.• [Address] group box Sets the address condition to be acquired.• [Trace buffer full break] group box No break: Acquires the latest information by overwriting the oldest information when the trace buffer becomes full. Break: Generates a break when the trace buffer becomes full.

(2) Displaying a Trace in the Bus Trace Function

The contents of the trace buffer in table 2.7 are displayed in the [Trace] window.

PTR	IP	Cycle	Type	Address	Instruction	Data	R/W	Area	Bus_Status	Clock	IRQ	Source	Label
-000511	-D'0511			00000958	CMP.L ER5,ER4	1FD4	READ	ROM	PROG	1	0		
-000510	-D'0510			0000095A	BCS @loop4:8	45F6	READ	ROM	PROG	1	0		next_loop4
-000509	-D'0509			0000095C		1F90	READ	ROM	PROG	1	0		
-000508	-D'0508			00000952	MOV.B @ER4+,R2L	6C4A	READ	ROM	PROG	1	0		next_loop3
-000507	-D'0507			00000954	MOV.B R2L,@ER6	68EA	READ	ROM	PROG	1	0		loop4
-000506	-D'0506			00000DF5		00	READ	ROM	DATA	1	0		
-000505	-D'0505			00000956	ADDS.L #1,ER6	0B06	READ	ROM	PROG	1	0		
-000504	-D'0504			00FFA223		00	WRITE	RAM	DATA	1	0		
-000503	-D'0503			00000958	CMP.L ER5,ER4	1FD4	READ	ROM	PROG	1	0		
-000502	-D'0502			0000095A	BCS @loop4:8	45F6	READ	ROM	PROG	1	0		next_loop4
-000501	-D'0501			0000095C	CMP.L ER1,ER0	1F90	READ	ROM	PROG	1	0		
-000500	-D'0500			00000952		6C4A	READ	ROM	PROG	1	0		next_loop3
-000499	-D'0499			0000095E	BCS @loop3:8	45E4	READ	ROM	PROG	1	0		loop4
-000498	-D'0498			00000960	LDM.L @SP+,(ER4-ER6)	0120	READ	ROM	PROG	1	0		
-000497	-D'0497			00000944		0100	READ	ROM	PROG	1	0		
-000496	-D'0496			00000962		6D76	READ	ROM	PROG	1	0		loop3
-000495	-D'0495			00000964	MOV.W @ER7+,R2	6D72	READ	ROM	PROG	1	0		
-000494	-D'0494			00FFBBEA		0000	READ	RAM	DATA	1	0		
-000493	-D'0493			00FFBBEC		0000	READ	RAM	DATA	1	0		

Figure 2.3 [Trace] Window

Table 2.7 Items in the [Trace] Window

Item	Description
[PTR]	Pointer to a location in the trace buffer (+0 for the last executed instruction) (signed decimal)
[IP]	Instruction pointer
[Cycle]	Cycle
[Type]	Type of trace information BRANCH: Branch source instruction
[Address]	Address value
[Instruction]	Instruction mnemonic
[Data]	Data value
[R/W]	Read or write access
[Area]	Access area
[Bus_Status]	Bus cycle states
[Clock]	Bus cycle counts
[IRQ]	IRQ pins
[Source]	The C/C++ or assembly-language source program in which the trace is acquired
[Label]	Label information

For branch trace, items [Cycle], [Data], [R/W], [Area], [Bus_Status], [Clock], and [IRQ] are not displayed. For bus trace, items [IP] and [Type] are not displayed.

The column width of the [Trace] window can be adjusted by clicking and dragging the vertical separate line between columns. When the window is closed, the new column width is automatically saved.

The capacity of the trace buffer is limited. When the buffer becomes full, the oldest trace information is overwritten.

(3) Setting a Break Condition for Tracing

Selecting the [Trace] radio button in [Action] of the [Break condition 1] dialog box enables the functions listed below. The trace acquisition condition depends on the [Trace buffer full break] setting.

Trace start function:

Starts acquisition of trace information from the address specified in the [Break condition 1] dialog box and stops when the trace buffer becomes full. Select [Break] in [Trace buffer full break] of the [Acquisition] dialog box.

Trace stop function:

Starts acquisition of trace information from the start of the program and stops at the address specified in the [Break condition 1] dialog box. Select [No break] in [Trace buffer full break] of the [Acquisition] dialog box.

(4) Trace Filter Function

The emulator displays all the information that matches the specified conditions for all the trace data. The information is displayed by selecting [Filter...] from the popup menu that is displayed with the right-hand mouse button on the [Trace] window.

The filter condition is set to restrict the cycle to be displayed on the trace buffer.

(i) [General] Page Options

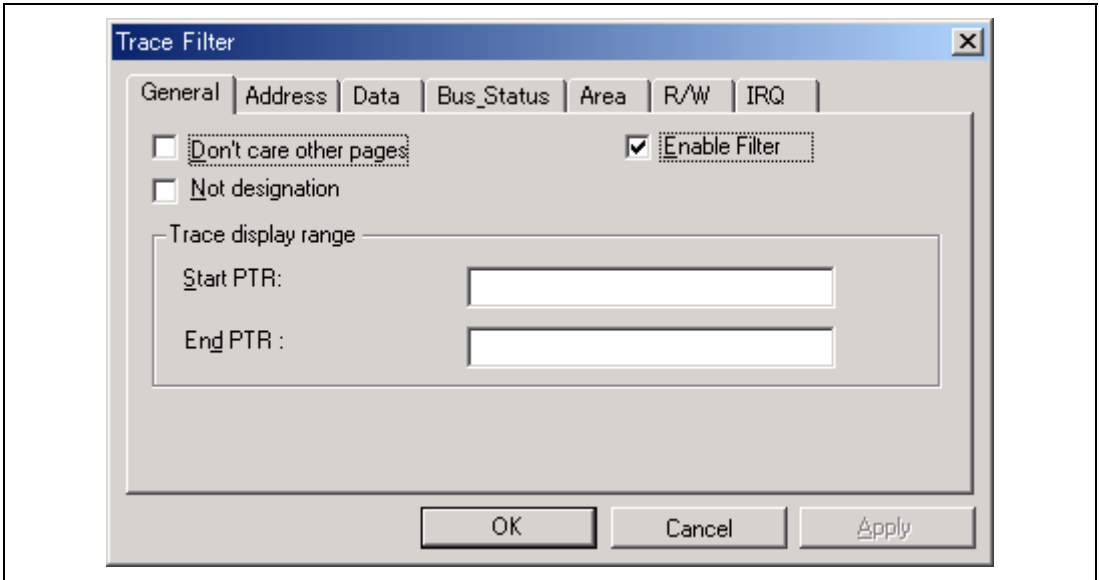

Figure 2.4 [General] Page

Table 2.8 [General] Page Options

Option	Description
[Don't care other pages] check box	Disables settings on other pages than the [General] page.
[Enable Filter] check box	Enables filter conditions.
[Not designation] check box	Designates no conditions.
[Start PTR] edit box	Enters the start pointer in the range that is displayed on the [Trace] window.
[End PTR] edit box	Enters the end pointer in the range that is displayed on the [Trace] window.

(ii) [Address] Page Options

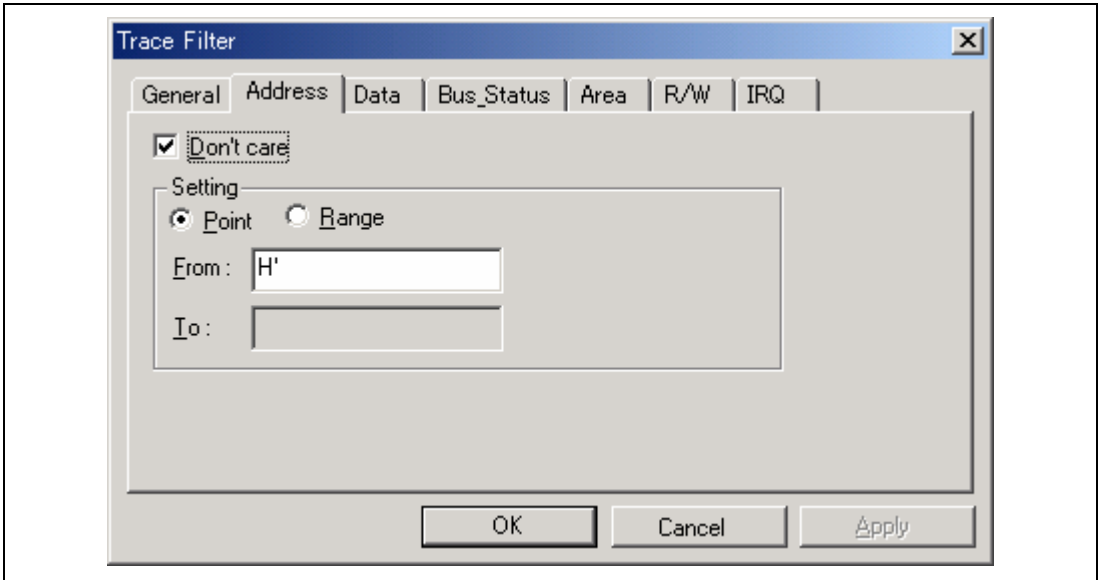

Figure 2.5 [Address] Page

Table 2.9 [Address] Page Options

Option	Description
[Don't care] check box	Indicates that no address condition is set.
[Point] radio button	Specifies the single address.
[Range] radio button	Sets an address range as a display condition.
[From] edit box	Sets the start value of the address range.
[To] edit box	Sets the end value of the address range.

(iii) [Data] Page Options

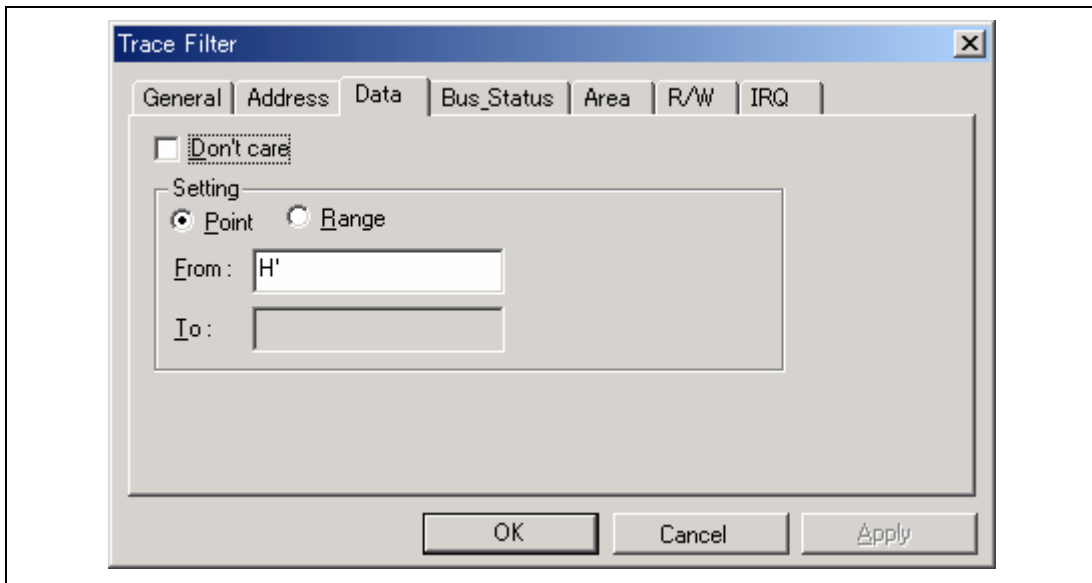

Figure 2.6 [Data] Page

Table 2.10 [Data] Page Options

Option	Description
[Don't care] check box	Indicates that no data condition is set.
[Point] radio button	Specifies the single data value.
[Range] radio button	Sets a range of the data value as a display condition.
[From] edit box	Sets the start value of the data value.
[To] edit box	Sets the end value of the data value.

(iv) [Bus_Status] Page Options

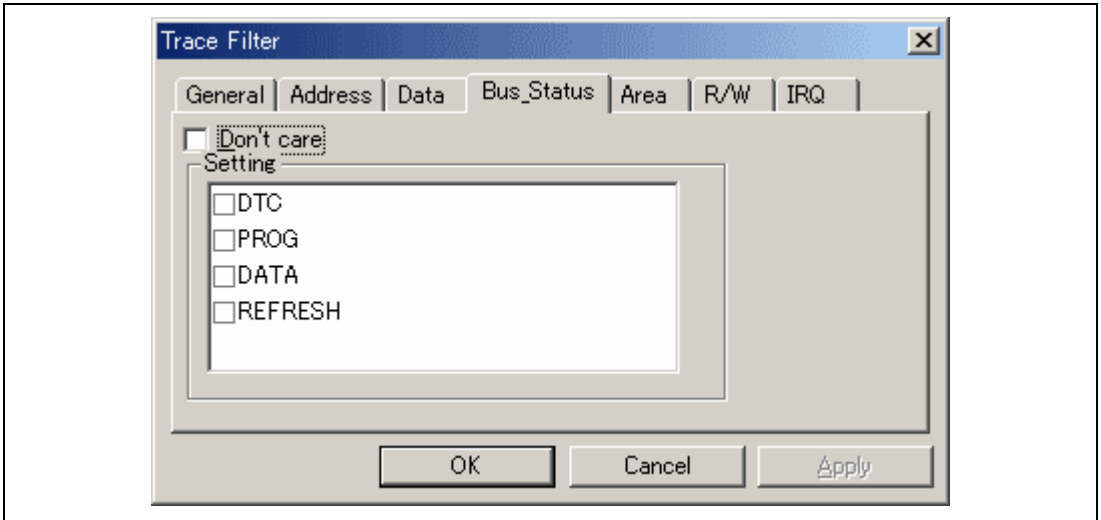

Figure 2.7 [Bus_Status] Page

Table 2.11 [Bus_Status] Page Options

Option	Description
[Don't care] check box	Indicates that no Bus_Status condition is set.
[Setting] group box	Specifies the bus status. DTC: DTC cycle PROG: CPU-instruction fetch cycle DATA: CPU-data access cycle REFRESH: Refresh cycle

(v) [Area] Page Options

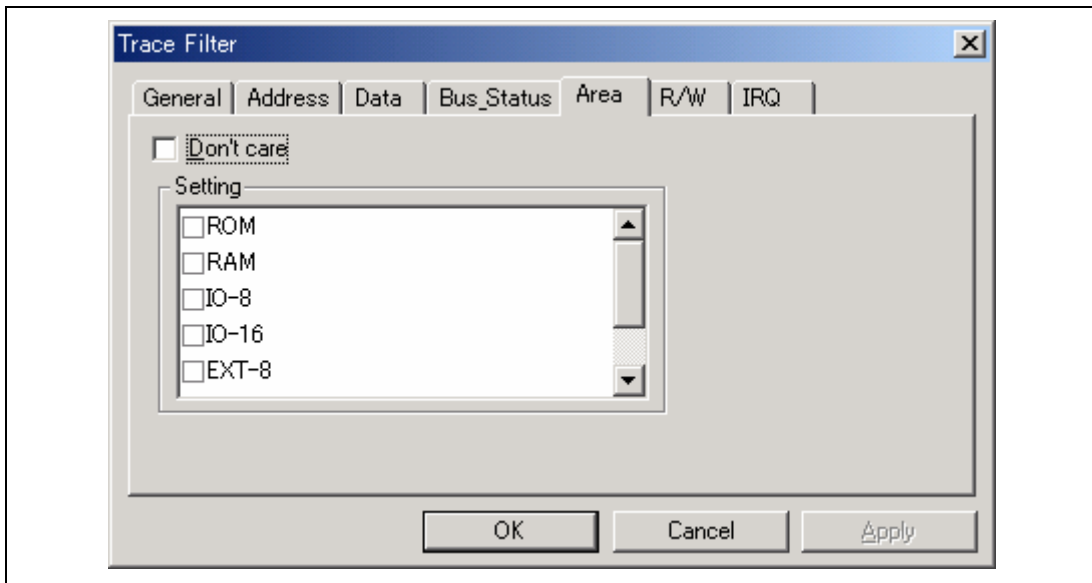

Figure 2.8 [Area] Page

Table 2.12 [Area] Page Options

Option	Description
[Don't care] check box	Indicates that no area condition is set.
[Setting] group box	Specifies the area. ROM: ROM area RAM: RAM area IO-8: IO-8 area IO-16: IO-16 area EXT-8: EXT-8 area EXT-16: EXT-16 area

(vi) [R/W] Page Options

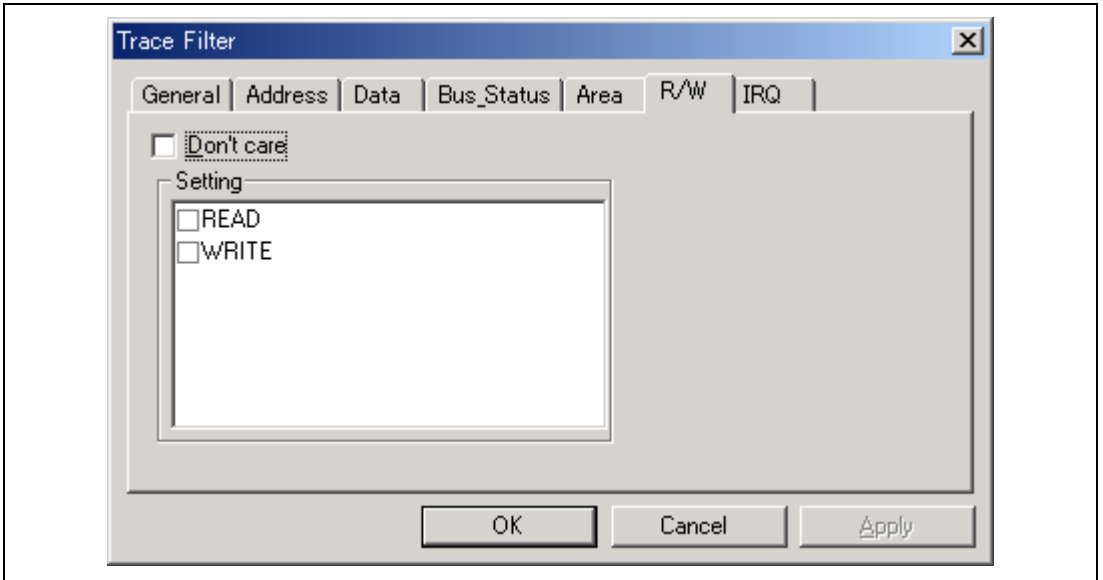

Figure 2.9 [R/W] Page

Table 2.13 [R/W] Page Options

Option	Description
[Don't care] check box	Indicates that no read/write condition is set.
[Setting] group box	Specifies the read/write. READ: Read cycle WRITE: Write cycle

(vii) [IRQ] Page Options

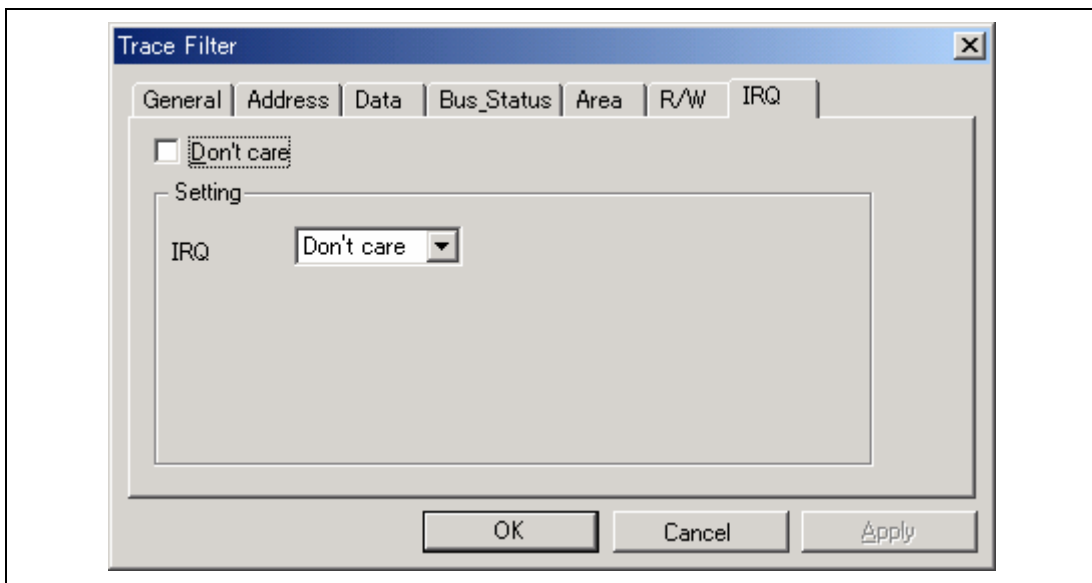

Figure 2.10 [IRQ] Page

Table 2.14 [IRQ] Page Options

Option	Description
[Don't care] check box	Indicates that no IRQ condition is set.
[IRQ] drop-down list	Specifies the IRQ. Don't care: Detects no IRQ. High: IRQ is high. Low: IRQ is low.

(5) Trace Find Function

The emulator jumps to the information that matches the conditions specified by all the trace data on the [Trace] window. The search condition is set in the [Trace Filter] dialog box. The information is displayed by selecting [Find...] from the popup menu that is displayed with the right-hand mouse button on the [Trace] window.

(i) [General] Page Options

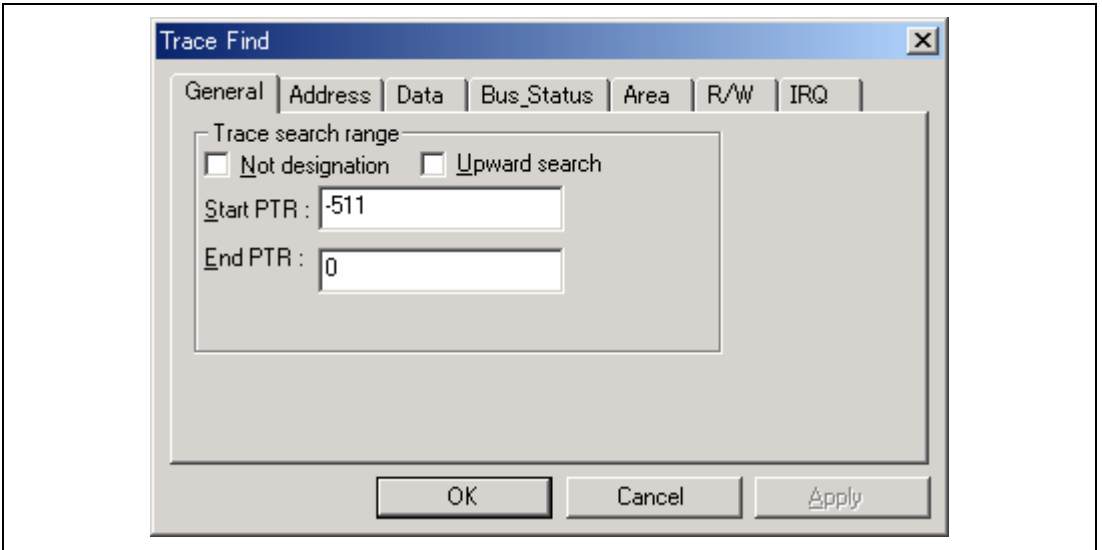

Figure 2.11 [General] Page

Table 2.15 [General] Page Options

Option	Description
[Not designation] check box	Designates no conditions.
[Upward search] check box	Performs upward search.
[Start PTR] edit box	Enters the pointer to start searching conditions.
[End PTR] edit box	Enters the pointer to end searching conditions.

(ii) [Address] Page Options

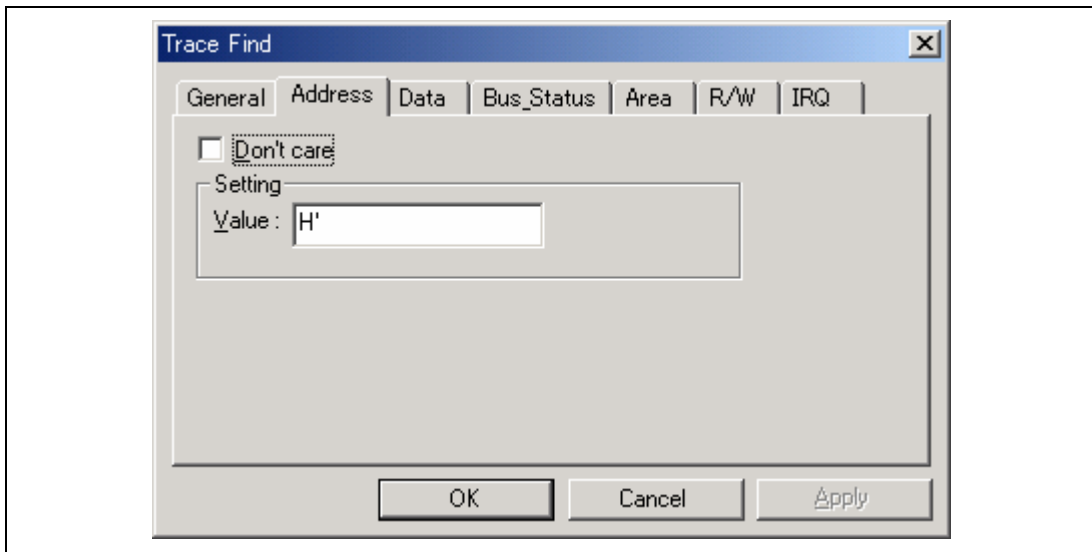

Figure 2.12 [Address] Page

Table 2.16 [Address] Page Options

Option	Description
[Don't care] check box	Indicates that no address condition is set.
[Value] edit box	Enters the address value.

(iii) [Data] Page Options

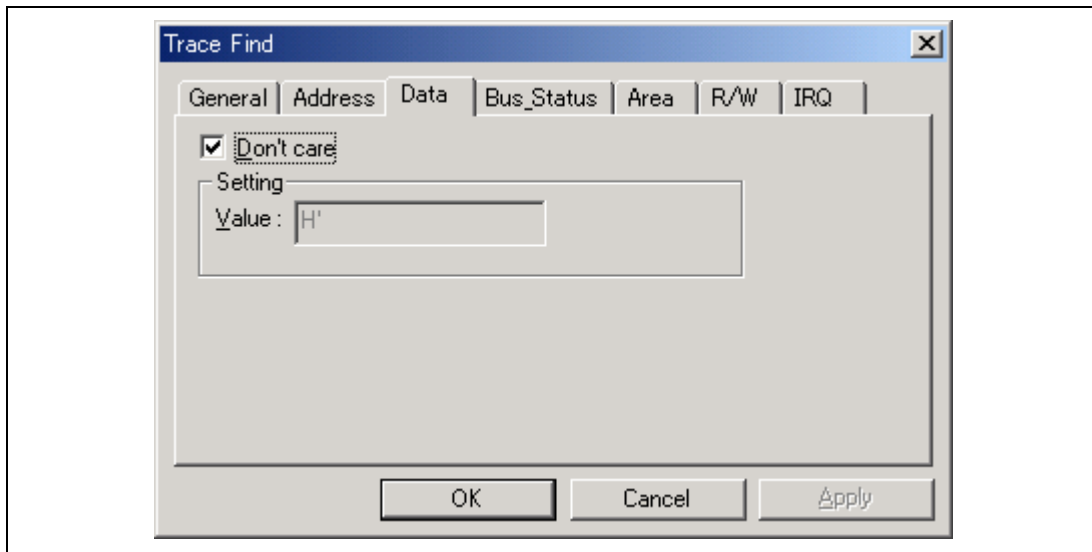

Figure 2.13 [Data] Page

Table 2.17 [Data] Page Options

Option	Description
[Don't care] check box	Indicates that no data condition is set.
[Value] edit box	Enters the data value.

(iv) [Bus_Status] Page Options

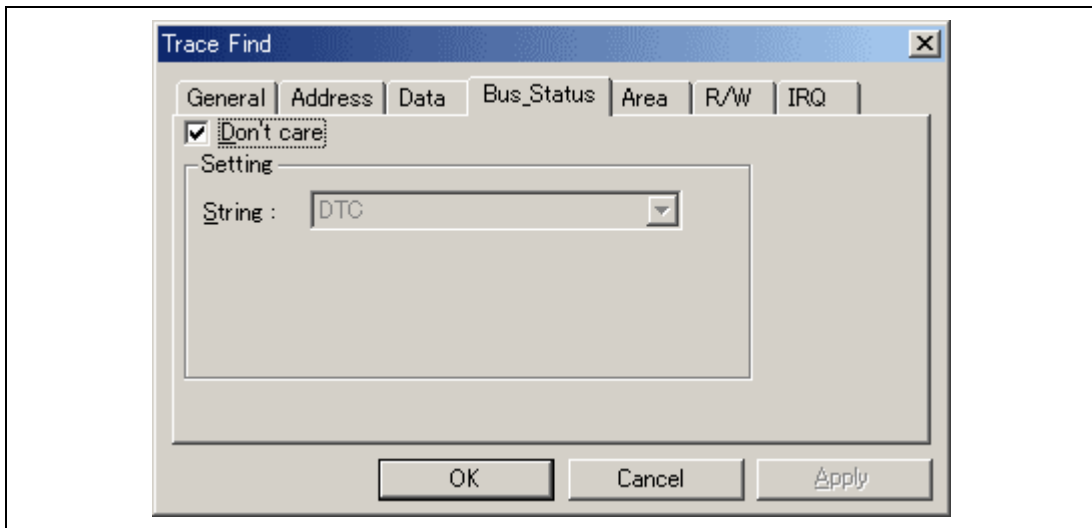

Figure 2.14 [Bus_Status] Page

Table 2.18 [Bus_Status] Page Options

Option	Description
[Don't care] check box	Indicates that no Bus_Status condition is set.
[String] drop-down list	Specifies the bus status. DTC: DTC cycle PROG: CPU-instruction fetch cycle DATA: CPU-data access cycle REFRESH: Refresh cycle

(v) [Area] Page Options

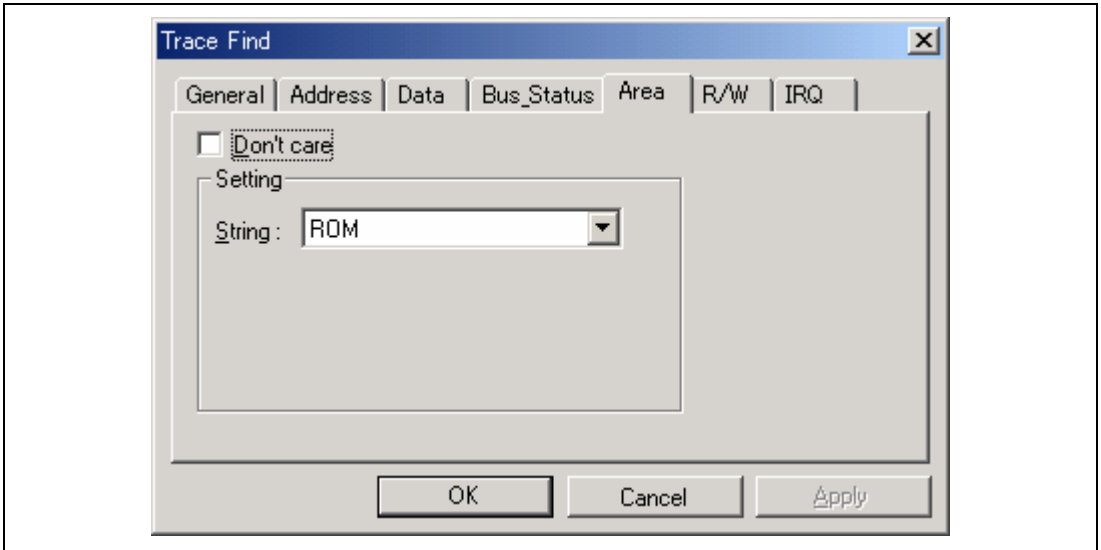

Figure 2.15 [Area] Page

Table 2.19 [Area] Page Options

Option	Description
[Don't care] check box	Indicates that no area condition is set.
[String] drop-down list	Specifies the area. ROM: ROM area RAM: RAM area IO-8: IO-8 area IO-16: IO-16 area EXT-8: EXT-8 area EXT-16: EXT-16 area

(vi) [R/W] Page Options

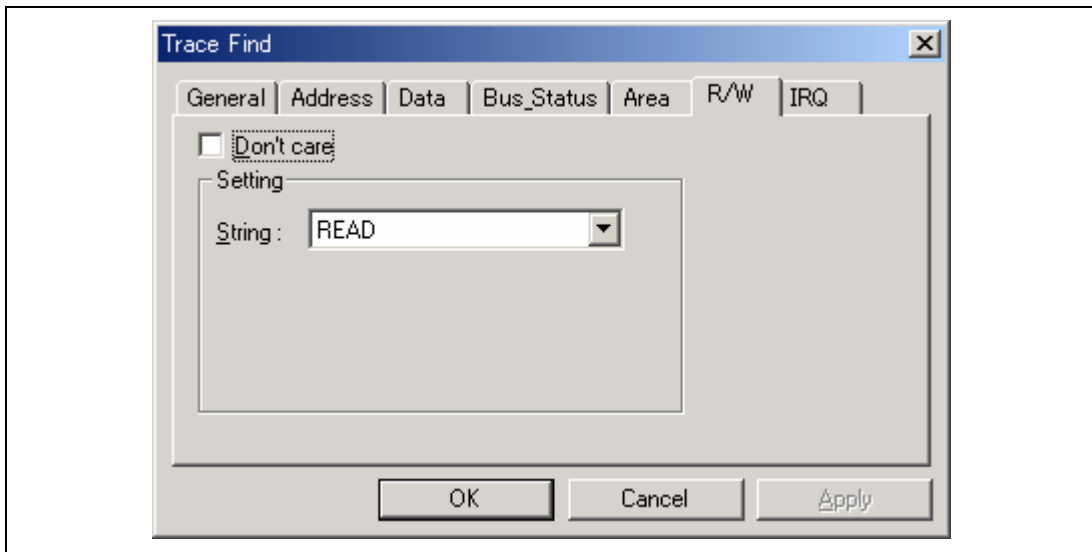

Figure 2.16 [R/W] Page

Table 2.20 [R/W] Page Options

Option	Description
[Don't care] check box	Indicates that no read/write condition is set.
[String] drop-down list	Specifies the read/write. READ: Read cycle WRITE: Write cycle

(vii) [IRQ] Page Options

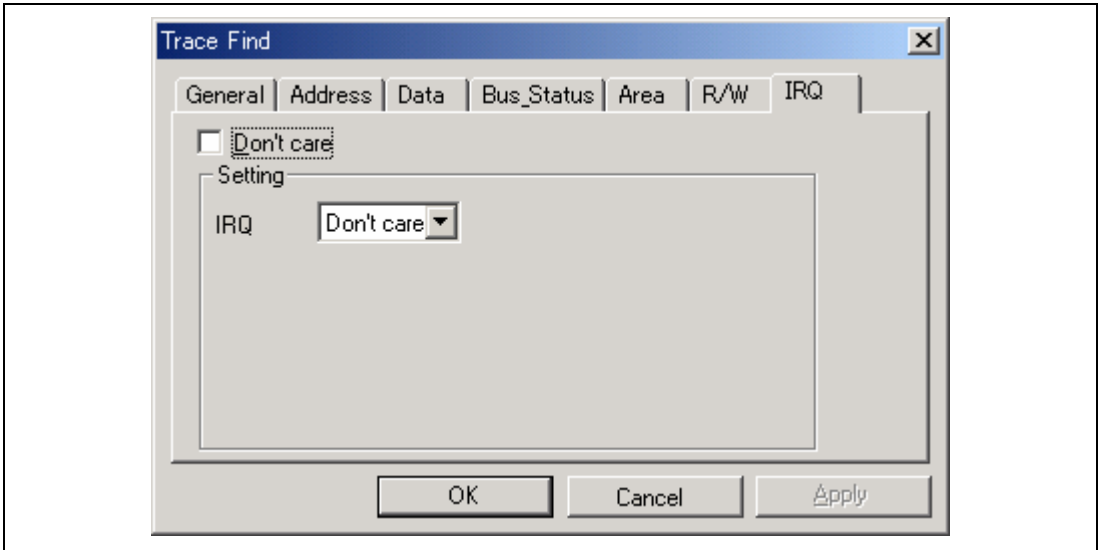

Figure 2.17 [IRQ] Page

Table 2.21 [IRQ] Page Options

Option	Description
[Don't care] check box	Indicates that no IRQ condition is set.
[IRQ] drop-down list	Specifies the IRQ. Don't care: Detects no IRQ. High: IRQ is high. Low: IRQ is low.

**H8S, H8SX Family E10A-USB Emulator
Additional Document for User's Manual
Supplementary Information on Using the H8S/2114RF**

Publication Date: Rev.1.00, November 28, 2003
Rev.2.00, November 15, 2007

Published by: Sales Strategic Planning Div.
Renesas Technology Corp.

Edited by: Customer Support Department
Global Strategic Communication Div.
Renesas Solutions Corp.

Renesas Technology Corp. Sales Strategic Planning Div. Nippon Bldg., 2-6-2, Ohte-machi, Chiyoda-ku, Tokyo 100-0004, Japan



RENESAS SALES OFFICES

<http://www.renesas.com>

Refer to "<http://www.renesas.com/en/network>" for the latest and detailed information.

Renesas Technology America, Inc.

450 Holger Way, San Jose, CA 95134-1368, U.S.A
Tel: <1> (408) 382-7500, Fax: <1> (408) 382-7501

Renesas Technology Europe Limited

Dukes Meadow, Millboard Road, Bourne End, Buckinghamshire, SL8 5FH, U.K.
Tel: <44> (1628) 585-100, Fax: <44> (1628) 585-900

Renesas Technology (Shanghai) Co., Ltd.

Unit 204, 205, AZIACenter, No.1233 Lujiazui Ring Rd, Pudong District, Shanghai, China 200120
Tel: <86> (21) 5877-1818, Fax: <86> (21) 6887-7898

Renesas Technology Hong Kong Ltd.

7th Floor, North Tower, World Finance Centre, Harbour City, 1 Canton Road, Tsimshatsui, Kowloon, Hong Kong
Tel: <852> 2265-6688, Fax: <852> 2730-6071

Renesas Technology Taiwan Co., Ltd.

10th Floor, No.99, Fushing North Road, Taipei, Taiwan
Tel: <886> (2) 2715-2888, Fax: <886> (2) 2713-2999

Renesas Technology Singapore Pte. Ltd.

1 Harbour Front Avenue, #06-10, Keppel Bay Tower, Singapore 098632
Tel: <65> 6213-0200, Fax: <65> 6278-8001

Renesas Technology Korea Co., Ltd.

Kukje Center Bldg. 18th Fl., 191, 2-ka, Hangang-ro, Yongsan-ku, Seoul 140-702, Korea
Tel: <82> (2) 796-3115, Fax: <82> (2) 796-2145

Renesas Technology Malaysia Sdn. Bhd

Unit 906, Block B, Menara Amcorp, Amcorp Trade Centre, No.18, Jalan Persiaran Barat, 46050 Petaling Jaya, Selangor Darul Ehsan, Malaysia
Tel: <603> 7955-9390, Fax: <603> 7955-9510

**H8S, H8SX Family E10A-USB Emulator
Additional Document for User's Manual
Supplementary Information on
Using the H8S/2114RF**



Renesas Electronics Corporation

1753, Shimonumabe, Nakahara-ku, Kawasaki-shi, Kanagawa 211-8668 Japan

REJ10B0151-0200