

# RA6M3 Group

Evaluation Kit for RA6M3 Microcontroller Group  
EK-RA6M3 v1  
Errata

Renesas RA Family  
RA6 Series

All information contained in these materials, including products and product specifications, represents information on the product at the time of publication and is subject to change by Renesas Electronics Corp. without notice. Please review the latest information published by Renesas Electronics Corp. through various means, including the Renesas Electronics Corp. website (<http://www.renesas.com>).

## Notice

1. Descriptions of circuits, software and other related information in this document are provided only to illustrate the operation of semiconductor products and application examples. You are fully responsible for the incorporation or any other use of the circuits, software, and information in the design of your product or system. Renesas Electronics disclaims any and all liability for any losses and damages incurred by you or third parties arising from the use of these circuits, software, or information.
  2. Renesas Electronics hereby expressly disclaims any warranties against and liability for infringement or any other claims involving patents, copyrights, or other intellectual property rights of third parties, by or arising from the use of Renesas Electronics products or technical information described in this document, including but not limited to, the product data, drawings, charts, programs, algorithms, and application examples.
  3. No license, express, implied or otherwise, is granted hereby under any patents, copyrights or other intellectual property rights of Renesas Electronics or others.
  4. You shall not alter, modify, copy, or reverse engineer any Renesas Electronics product, whether in whole or in part. Renesas Electronics disclaims any and all liability for any losses or damages incurred by you or third parties arising from such alteration, modification, copying or reverse engineering.
  5. Renesas Electronics products are classified according to the following two quality grades: "Standard" and "High Quality". The intended applications for each Renesas Electronics product depends on the product's quality grade, as indicated below.
    - "Standard": Computers; office equipment; communications equipment; test and measurement equipment; audio and visual equipment; home electronic appliances; machine tools; personal electronic equipment; industrial robots; etc.
    - "High Quality": Transportation equipment (automobiles, trains, ships, etc.); traffic control (traffic lights); large-scale communication equipment; key financial terminal systems; safety control equipment; etc.
- Unless expressly designated as a high reliability product or a product for harsh environments in a Renesas Electronics data sheet or other Renesas Electronics document, Renesas Electronics products are not intended or authorized for use in products or systems that may pose a direct threat to human life or bodily injury (artificial life support devices or systems; surgical implantations; etc.), or may cause serious property damage (space system; undersea repeaters; nuclear power control systems; aircraft control systems; key plant systems; military equipment; etc.). Renesas Electronics disclaims any and all liability for any damages or losses incurred by you or any third parties arising from the use of any Renesas Electronics product that is inconsistent with any Renesas Electronics data sheet, user's manual or other Renesas Electronics document.
6. When using Renesas Electronics products, refer to the latest product information (data sheets, user's manuals, application notes, "General Notes for Handling and Using Semiconductor Devices" in the reliability handbook, etc.), and ensure that usage conditions are within the ranges specified by Renesas Electronics with respect to maximum ratings, operating power supply voltage range, heat dissipation characteristics, installation, etc. Renesas Electronics disclaims any and all liability for any malfunctions, failure or accident arising out of the use of Renesas Electronics products outside of such specified ranges.
  7. Although Renesas Electronics endeavors to improve the quality and reliability of Renesas Electronics products, semiconductor products have specific characteristics, such as the occurrence of failure at a certain rate and malfunctions under certain use conditions. Unless designated as a high reliability product or a product for harsh environments in a Renesas Electronics data sheet or other Renesas Electronics document, Renesas Electronics products are not subject to radiation resistance design. You are responsible for implementing safety measures to guard against the possibility of bodily injury, injury or damage caused by fire, and/or danger to the public in the event of a failure or malfunction of Renesas Electronics products, such as safety design for hardware and software, including but not limited to redundancy, fire control and malfunction prevention, appropriate treatment for aging degradation or any other appropriate measures. Because the evaluation of microcomputer software alone is very difficult and impractical, you are responsible for evaluating the safety of the final products or systems manufactured by you.
  8. Please contact a Renesas Electronics sales office for details as to environmental matters such as the environmental compatibility of each Renesas Electronics product. You are responsible for carefully and sufficiently investigating applicable laws and regulations that regulate the inclusion or use of controlled substances, including without limitation, the EU RoHS Directive, and using Renesas Electronics products in compliance with all these applicable laws and regulations. Renesas Electronics disclaims any and all liability for damages or losses occurring as a result of your noncompliance with applicable laws and regulations.
  9. Renesas Electronics products and technologies shall not be used for or incorporated into any products or systems whose manufacture, use, or sale is prohibited under any applicable domestic or foreign laws or regulations. You shall comply with any applicable export control laws and regulations promulgated and administered by the governments of any countries asserting jurisdiction over the parties or transactions.
  10. It is the responsibility of the buyer or distributor of Renesas Electronics products, or any other party who distributes, disposes of, or otherwise sells or transfers the product to a third party, to notify such third party in advance of the contents and conditions set forth in this document.
  11. This document shall not be reprinted, reproduced or duplicated in any form, in whole or in part, without prior written consent of Renesas Electronics.
  12. Please contact a Renesas Electronics sales office if you have any questions regarding the information contained in this document or Renesas Electronics products.

(Note1) "Renesas Electronics" as used in this document means Renesas Electronics Corporation and also includes its directly or indirectly controlled subsidiaries.

(Note2) "Renesas Electronics product(s)" means any product developed or manufactured by or for Renesas Electronics.

(Rev.4.0-1 November 2017)

## Corporate Headquarters

TOYOSU FORESIA, 3-2-24 Toyosu,  
Koto-ku, Tokyo 135-0061, Japan  
[www.renesas.com](http://www.renesas.com)

## Trademarks

Renesas and the Renesas logo are trademarks of Renesas Electronics Corporation. All trademarks and registered trademarks are the property of their respective owners.

## Contact information

For further information on a product, technology, the most up-to-date version of a document, or your nearest sales office, please visit:  
[www.renesas.com/contact/](http://www.renesas.com/contact/).

## Renesas EK-RA6M3 Disclaimer

By using this EK-RA6M3, the User accepts the following terms, which are in addition to, and control in the event of disagreement, with Renesas' General Terms and Conditions available at <https://www.renesas.com/en-us/legal/disclaimer.html>.

The EK-RA6M3 is not guaranteed to be error free, and the entire risk as to the results and performance of the EK-RA6M3 is assumed by the User. The EK-RA6M3 is provided by Renesas on an "as is" basis without warranty of any kind whether express or implied, including but not limited to the implied warranties of good workmanship, fitness for a particular purpose, title, merchantability, and non-infringement of intellectual property rights. Renesas expressly disclaims any implied warranty.

Renesas does not consider the EK-RA6M3 to be a finished product and therefore the EK-RA6M3 may not comply with some requirements applicable to finished products, including, but not limited to recycling, restricted substances and electromagnetic compatibility regulations. Refer to Certifications section, for information about certifications and compliance information for the EK-RA6M3. It is the kit User's responsibility to make sure the kit meets any local requirements applicable to their region.

Renesas or its affiliates shall in no event be liable for any loss of profit, loss of data, loss of contract, loss of business, damage to reputation or goodwill, any economic loss, any reprogramming or recall costs (whether the foregoing losses are direct or indirect) nor shall Renesas or its affiliates be liable for any other direct or indirect special, incidental or consequential damages arising out of or in relation to the use of this EK-RA6M3, even if Renesas or its affiliates have been advised of the possibility of such damages.

Renesas has used reasonable care in preparing the information included in this document, but Renesas does not warrant that such information is error free nor does Renesas guarantee an exact match for every application or parameter to part numbers designated by other vendors listed herein. The information provided in this document is intended solely to enable the use of Renesas products. No express or implied license to any intellectual property right is granted by this document or in connection with the sale of Renesas products. Renesas reserves the right to make changes to specifications and product descriptions at any time without notice. Renesas assumes no liability for any damages incurred by you resulting from errors in or omissions from the information included herein. Renesas cannot verify, and assumes no liability for, the accuracy of information available on another company's website.

## Precautions

This Evaluation Kit is only intended for use in a laboratory environment under ambient temperature and humidity conditions. A safe separation distance should be used between this and any sensitive equipment. Its use outside the laboratory, classroom, study area, or similar such area invalidates conformity with the protection requirements of the Electromagnetic Compatibility Directive and could lead to prosecution.

The product generates, uses, and can radiate radio frequency energy and may cause harmful interference to radio communications. There is no guarantee that interference will not occur in a particular installation. If this equipment causes harmful interference to radio or television reception, which can be determined by turning the equipment off or on, you are encouraged to try to correct the interference by one or more of the following measures:

- Ensure attached cables do not lie across the equipment.
- Reorient the receiving antenna.
- Increase the distance between the equipment and the receiver.
- Connect the equipment into an outlet on a circuit different from that which the receiver is connected.
- Power down the equipment when not in use.
- Consult the dealer or an experienced radio/TV technician for help.

Note: It is recommended that wherever possible shielded interface cables are used.

The product is potentially susceptible to certain EMC phenomena. To mitigate against them it is recommended that the following measures be undertaken:

- The user is advised that mobile phones should not be used within 10 m of the product when in use.
- The user is advised to take ESD precautions when handling the equipment.

The Evaluation Kit does not represent an ideal reference design for an end product and does not fulfill the regulatory standards for an end product.

## Renesas RA Family

**EK-RA6M3 v1**
**Contents**

1. Introduction.....	5
2. Known Issues and Exceptions .....	5
2.1 USB High Speed Performance.....	5
2.2 Package Type on the Board Silk Screen for RA6M3 MCU.....	6
2.3 P105 Not Connected Correctly.....	7
2.4 USB Full-Speed Device Mode Cable Disconnect Detection .....	8
2.5 USB High-Speed Device Mode Cable Disconnect Detection .....	9
3. Appendix – Kit Identification.....	10
4. Website and Support .....	12
Revision History .....	13

**Figures**

Figure 1. C28 and C29 Location.....	5
Figure 2. Package Type on Silk Screen .....	6
Figure 3. P105 Rework Pin Locations .....	7
Figure 4. USB Full Speed Rework Locations .....	8
Figure 5. USB High Speed Rework Locations .....	9
Figure 6. Identification of the Kit Version Number on the EK-RA6M3 Kit Packaging .....	10
Figure 7. Identification of the Kit Version Number on the EK-RA6M3 Board .....	10
Figure 8. Identification of the Serial Number .....	10
Figure 9. Identification of the Manufacturing Date Code .....	11

## 1. Introduction

This Errata describes the known issues and exceptions to the functional specifications for the EK-RA6M3 v1, Evaluation Kit for the RA6M3 MCU Group. For additional information on the kit, see the EK-RA6M3 v1 user's manual.

## 2. Known Issues and Exceptions

### 2.1 USB High Speed Performance

#### Description

The USB High Speed (USB HS) port may exhibit connection problems or performance degradation when operating the USB HS port at the highest specified speed.

#### Corrective Action

To improve the function of the USB HS port, remove capacitors C28 and C29.

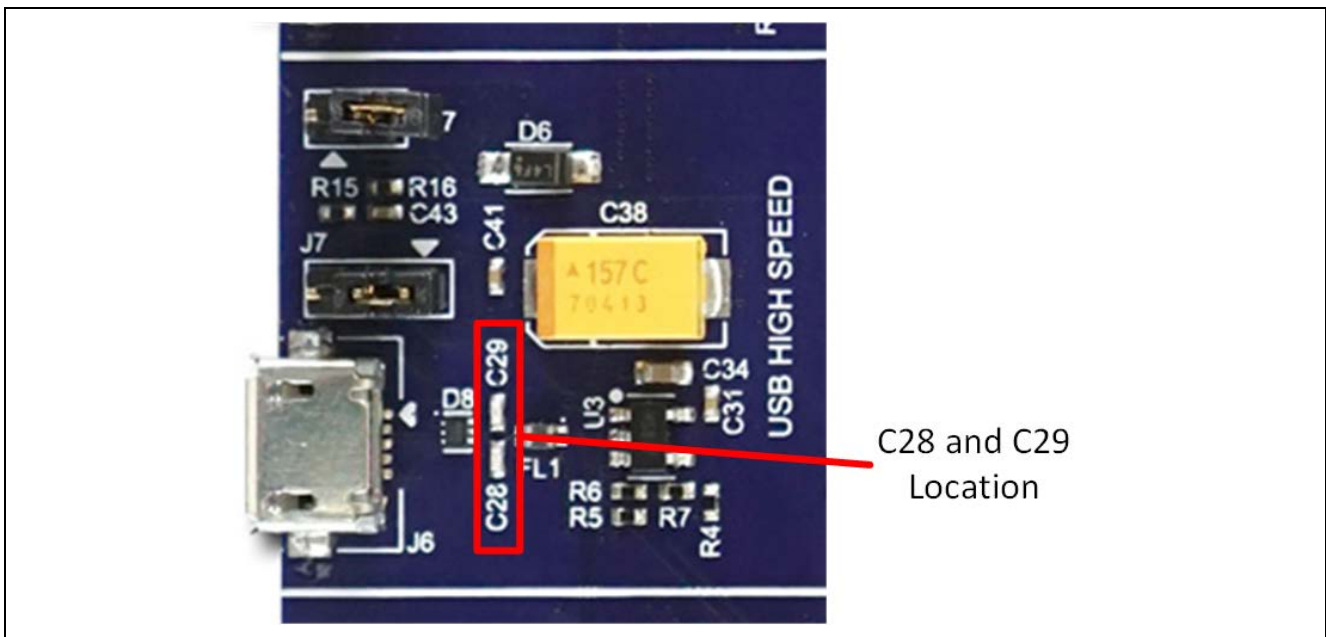

Figure 1. C28 and C29 Location

#### Kits Affected

Version : 1  
Serial number : 001 to 720  
Manufacturing date code : 1934 or 1938

See the Appendix – Kit Identification section for information on locating the kit version, serial number and manufacturing date code.

## 2.2 Package Type on the Board Silk Screen for RA6M3 MCU

### Description

The silk screen on the EK-RA6M3 board shows an incorrect package type for the RA6M3 MCU. The incorrect silk screen identifies the package type as LQFP144. The actual package type is LQFP176.

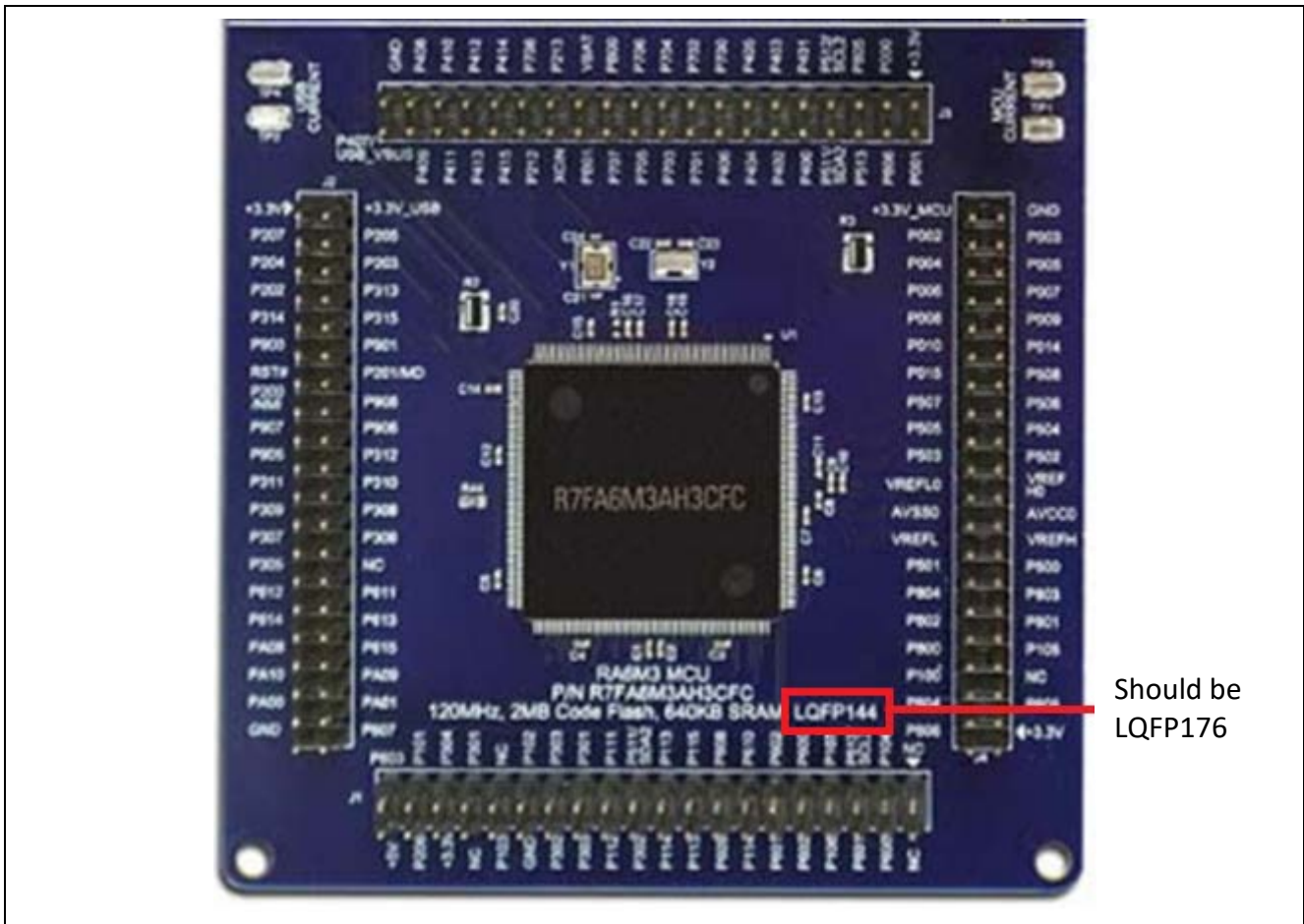

Figure 2. Package Type on Silk Screen

### Corrective Action

No corrective action is needed. The silk screen is correct on later builds of the board.

### Kits Affected

Version : 1  
 Serial number : 001 to 720  
 Manufacturing date code : 1934 or 1938

See the Appendix – Kit Identification section for information on locating the kit version, serial number and manufacturing date code.

### 2.3 P105 Not Connected Correctly

#### Description

P105 is not connected between J4 pin 7 and J25 pin 2. As a result, PMOD 2 may not function correctly.

#### Corrective Action

A wire may be added between J4 pin 7 and J25 pin 2. This will add the correct functionality to PMOD 2. It is recommended to add rework wire on the bottom side of the board.

This error has been corrected on later builds of the board.

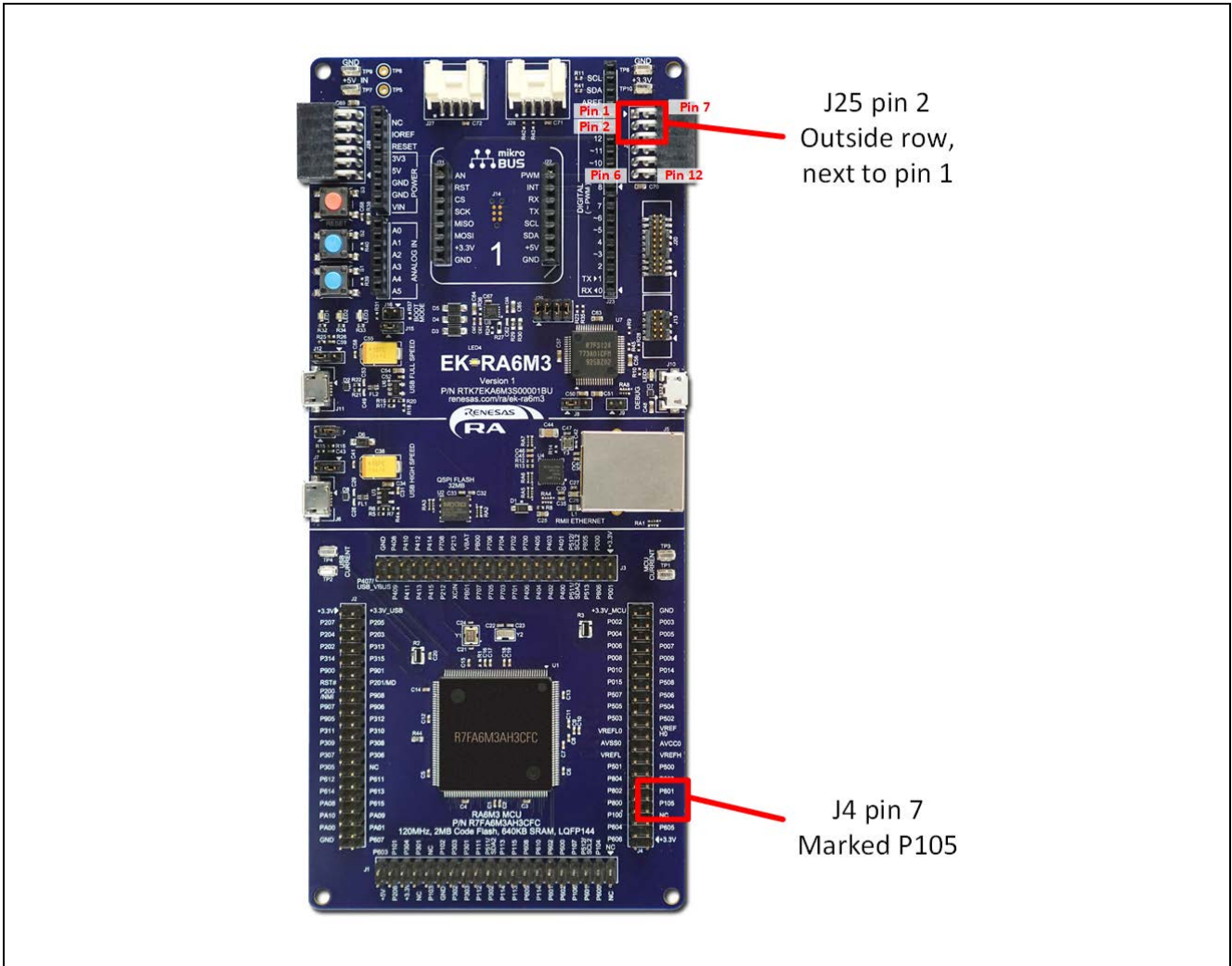

Figure 3. P105 Rework Pin Locations

#### Kits Affected

Version : 1  
 Serial number : 001 to 720  
 Manufacturing date code : 1934 or 1938

See the Appendix – Kit Identification section for information on locating the kit version, serial number and manufacturing date code.

## 2.4 USB Full Speed Device Mode Cable Disconnect Detection

### Description

When configured in Device Mode, the USB Full Speed peripheral in the RA6M3 MCU uses the USB\_VBUS signal (P407) to detect the presence of a USB cable connected to J11. Due to voltage leakage through the ESD protection circuit D2, the voltage on P407/USB\_VBUS may not drop low enough to detect detaching a cable at J11. This may prevent the USB Full Speed port from detecting that cable has been disconnected. The issue occurs when a cable is first connected to the USB port and is properly configured, then the cable is disconnected.

### Corrective Action

There are two possible methods to enable correct operation of the USB Full Speed port in self-powered mode. Implementing either method will resolve the issue. It is not necessary to implement both methods.

1. (Recommended) Cut the +5V trace between D2 pin 6 and the rest of the USB Full Speed +5V trace. Cut the trace at the location indicated by the arrow in Figure 4. The trace is located next to the D2 reference designator on the top side of the circuit board.
2. Remove D2. This will eliminate the voltage leakage between the USB Full Speed data lines and the USB +5V. However, this will also remove the ESD protection provided by D2.

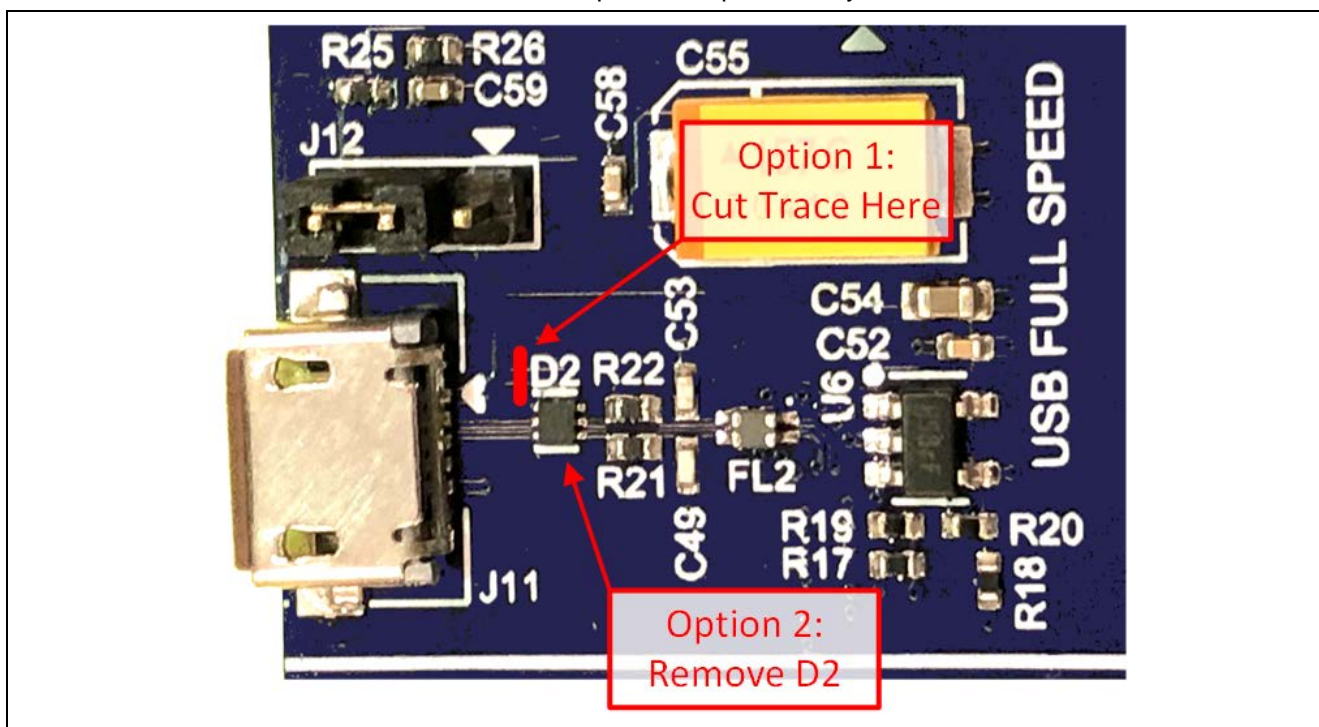

Figure 4. USB Full Speed Rework Locations

### Kits Affected

Version : 1  
 Serial number : 001-720  
 Manufacturing date code : 1934, 1938, 2002, 2003, or 2024

See the Appendix – Kit Identification section for information on locating the kit version, serial number and manufacturing date code.



## 2.5 USB High Speed Device Mode Cable Disconnect Detection

### Description

When configured in Device mode, the USB High Speed peripheral in the RA6M3 MCU uses the USBHS\_VBUS signal (PB01) to detect the presence of a USB cable connected to J6. Due to voltage leakage through the ESD protection circuit D2, the voltage on PB01/USBHS\_VBUS may not drop low enough to detect detaching a cable at J6. This may prevent the USB High Speed port from detecting that the cable has been disconnected. The issue occurs when a cable is first connected to the USB port and is properly configured, then the cable is disconnected.

### Corrective Action

There are two possible methods to enable correct operation of the USB Full Speed port in self-powered mode. Implementing either method will resolve the issue. It is not necessary to implement both methods.

1. (Recommended) Cut the +5V trace between D8 pin 6 and the rest of the USB High Speed +5V trace. Cut the trace at the location indicated in Figure 5. The trace is located next to the D8 reference designator on the top side of the circuit board.
2. Remove D8. This will eliminate the voltage leakage between the USB High Speed data lines and the USB +5V. However, this will also remove the ESD protection provided by D8.

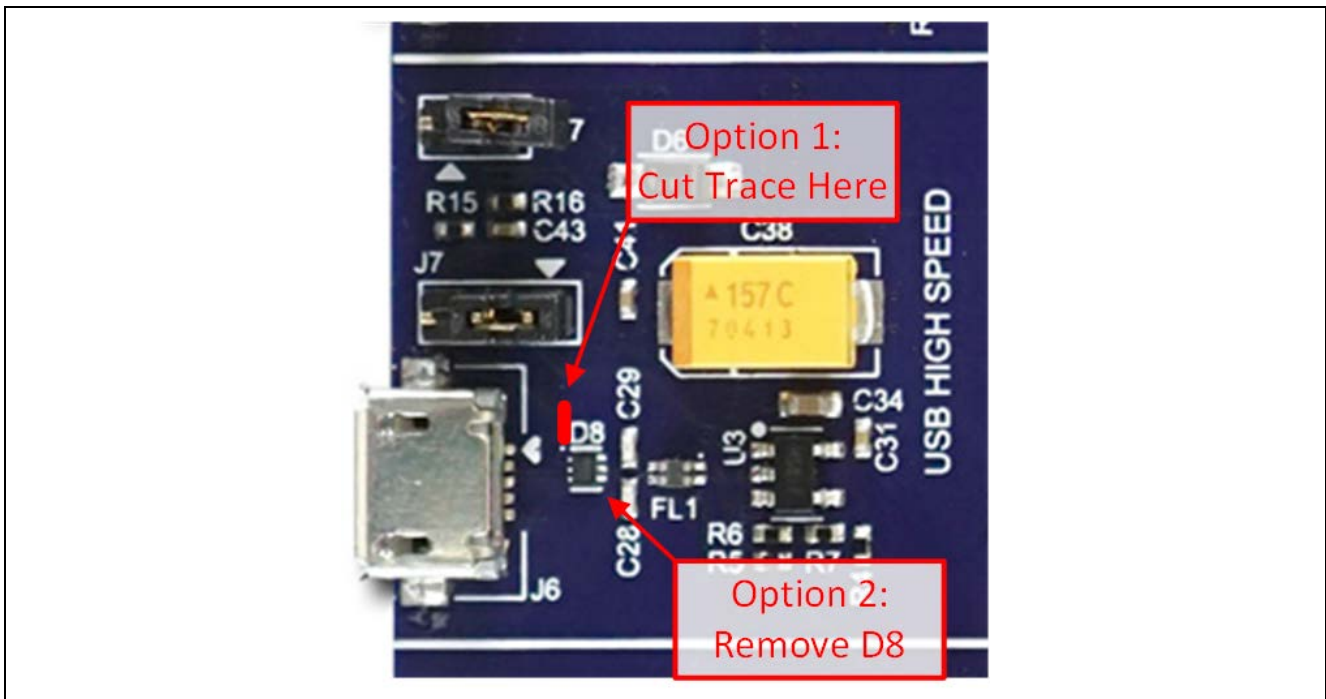

Figure 5. USB High Speed Rework Locations

### Kits Affected

Version : 1  
 Serial number : 001-720  
 Manufacturing date code : 1934, 1938, 2002, 2003, or 2024

See the Appendix – Kit Identification section for information on locating the kit version, serial number and manufacturing date code.

### 3. Appendix – Kit Identification

#### Kit Version

The kit version can be found on the EK-RA6M3 kit packaging and EK-RA6M3 board as described in this section. The kit version is the last digit in the orderable part number as shown in the second box in Figure 7. In the example below, the kit version number is “1” as shown in both Figure 6 and Figure 7.

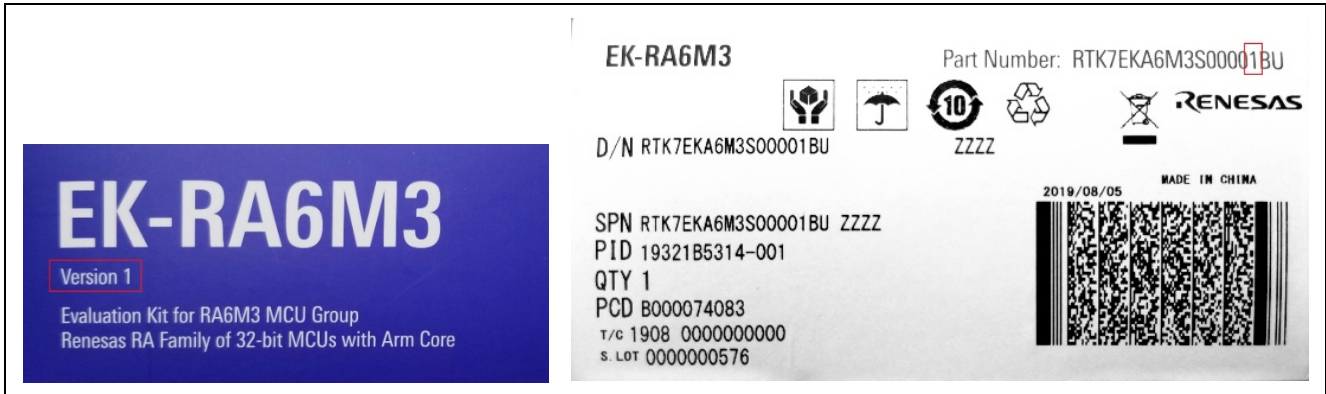

Figure 6. Identification of the Kit Version Number on the EK-RA6M3 Kit Packaging



Figure 7. Identification of the Kit Version Number on the EK-RA6M3 Board

#### Serial Number and Manufacturing Date Code

In addition to the kit version number, the kit serial number and the manufacturing date code are used to uniquely identify a kit.

The serial number is located on the QR code sticker on the back/bottom side of EK-RA6M3 board and on the bar code sticker of the EK-RA6M3 kit packaging. In the example in Figure 8, the serial number is “576.”

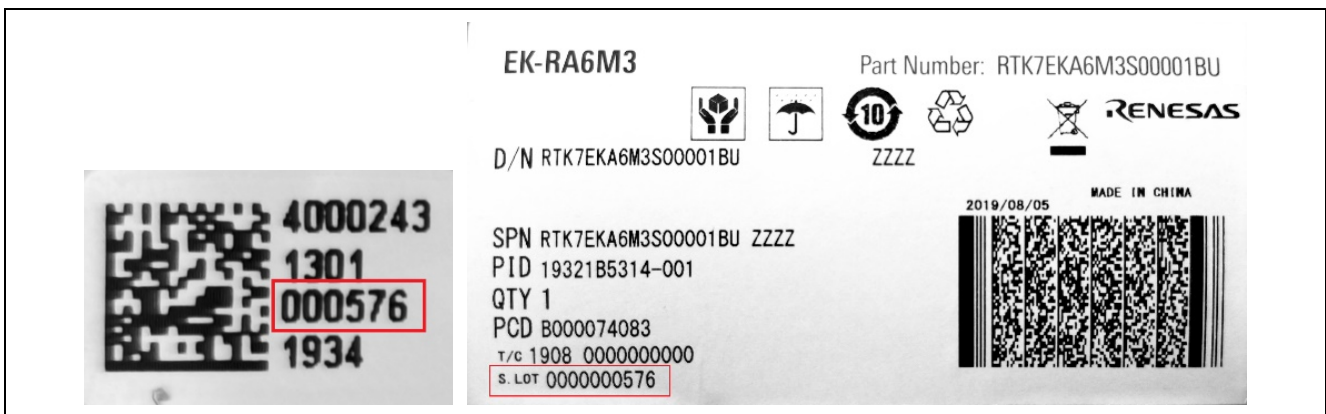
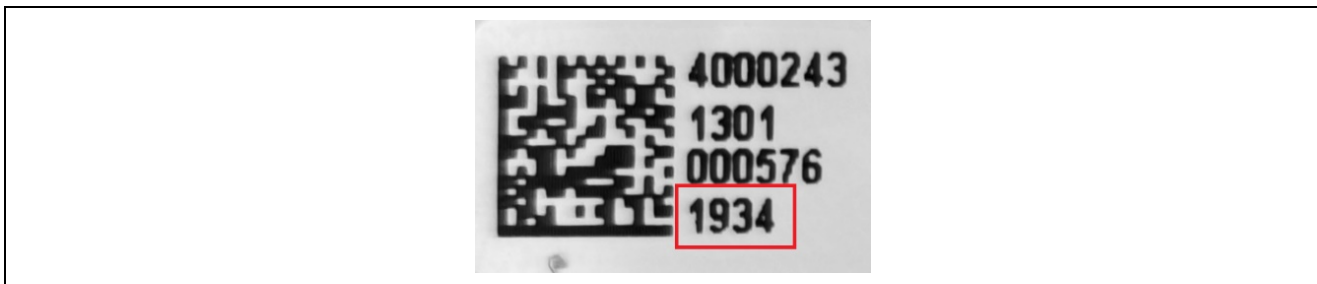

Figure 8. Identification of the Serial Number

The manufacturing date code is located on the QR code sticker on the back/bottom side of EK-RA6M3 board. In the example in Figure 9, the manufacturing date code is “1934.”



**Figure 9. Identification of the Manufacturing Date Code**

#### 4. Website and Support

Visit the following URLs to learn about the kit and the RA family of microcontrollers, download tools and documentation, and get support.

EK-RA6M3 Resources	<a href="https://renesas.com/ra/ek-ra6m3">renesas.com/ra/ek-ra6m3</a>
RA Product Information	<a href="https://renesas.com/ra">renesas.com/ra</a>
RA Product Support Forum	<a href="https://renesas.com/ra/forum">renesas.com/ra/forum</a>
Renesas Support	<a href="https://renesas.com/support">renesas.com/support</a>

**Revision History**

Rev.	Date	Description	
		Page	Summary
1.00	Nov.18.19	—	Initial release
1.01	Apr.17.20	—	Edited for clarity and completeness
1.02	Jul.21.20	—	Added information on USB Full Speed/High Speed Mode cable disconnection detection

---

EK-RA6M3 v1 – Errata

Publication Date: Jul.21.20

Published by: Renesas Electronics Corporation

---

# EK-RA6M3 v1 – Errata