

ISL80102, ISL80103

High Performance 2A and 3A Linear Regulators

FN6660  
Rev.9.02  
Jun 11, 2020

The [ISL80102](#) and [ISL80103](#) are low voltage, high-current, single output LDOs specified for 2A and 3A output current, respectively. These LDOs operate from the input voltages of 2.2V to 6V and are capable of providing the output voltages of 0.8V to 5.5V.

An external capacitor on the soft-start pin provides adjustment for applications that demand inrush current less than the current limit. The ENABLE feature allows the part to be placed into a low quiescent current shutdown mode. A submicron BiCMOS process is used for this product family to deliver best-in-class analog performance and overall value.

These CMOS (LDOs) consume significantly lower quiescent current as a function of load over bipolar LDOs, so they are more efficient and allow packages with smaller footprints. The quiescent current has been modestly compromised to enable a leading class fast load transient response, and hence a lower total AC regulation band for an LDO in this category.

**Related Literature**

For a full list of related documents, visit our website

- [ISL80102](#), [ISL80103](#) product pages

**Features**

- Stable with ceramic capacitors ([Note 11](#))
- 2A and 3A output current ratings
- 2.2V to 6V input voltage range
- $\pm 1.8\%$   $V_{OUT}$  accuracy assured over line, load, and  $T_J = -40^\circ C$  to  $+125^\circ C$
- Very low 120mV dropout voltage at 3A (ISL80103)
- Very fast transient response
- Excellent 62dB PSRR
- $49\mu V_{RMS}$  output noise
- Power-good output
- Adjustable inrush current limiting
- Short-circuit and over-temperature protection
- Available in a 10 Ld DFN

**Applications**

- Servers
- Telecommunications and networking
- Medical equipment
- Instrumentation systems
- Routers and switches

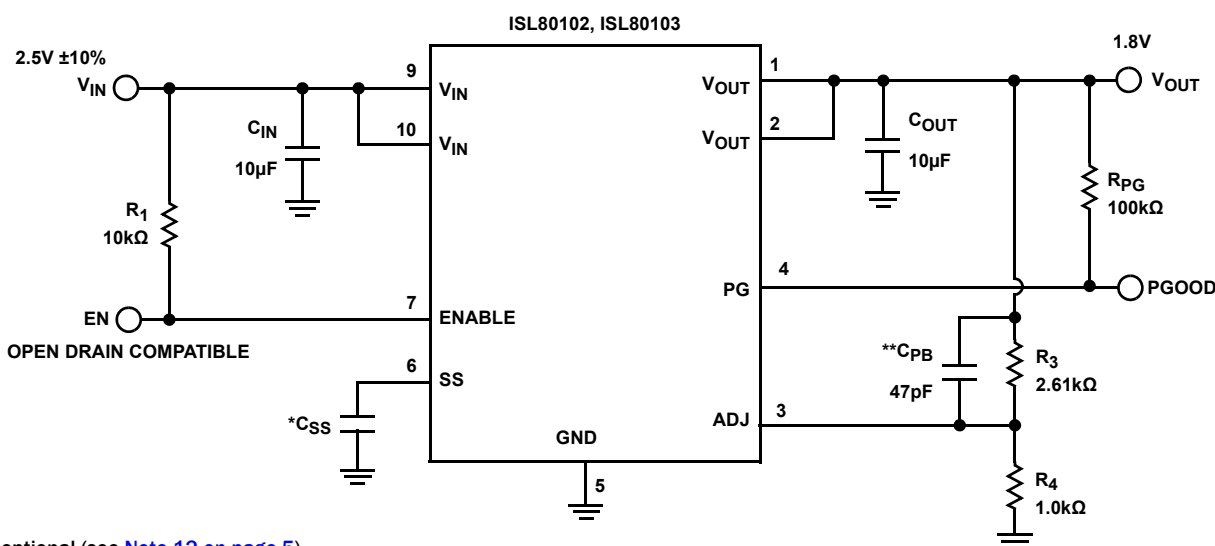

\* $C_{SS}$  is optional (see [Note 12 on page 5](#)).

\*\* $C_{PB}$  is optional (see ["Functional Description" on page 12](#) for more information).

FIGURE 1. TYPICAL APPLICATION DIAGRAM FOR ADJUSTABLE OUTPUT VOLTAGE VERSION

TABLE 1. COMPONENTS VALUE SELECTION

V <sub>OUT</sub> (V)	R <sub>TOP</sub> (kΩ)	R <sub>BOTTOM</sub> (Ω)	C <sub>PB</sub> (pF)	C <sub>OUT</sub> (μF)
5.0	2.61	287	47	10
3.3	2.61	464	47	10
2.5	2.61	649	47	10
1.8 (Note 1)	2.61	1.0k	47	10
1.8 (Note 1)	2.61	1.0k	82	22
1.5	2.61	1.3k	82	22
1.2	2.61	1.87k	150	47
1.0	2.61	2.61k	150	47
0.8	2.61	4.32k	150	47

NOTE:

1. Either option can be used depending on cost/performance requirements

### Pin Configuration

10 LD 3x3 DFN  
TOP VIEW

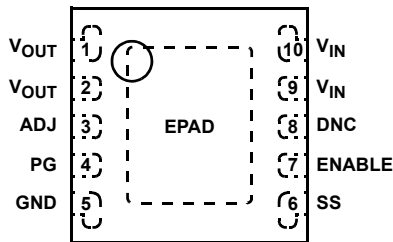

### Pin Descriptions

PIN NUMBER	PIN NAME	DESCRIPTION
1, 2	V <sub>OUT</sub>	Output voltage pin
3	ADJ	ADJ pin for externally set V <sub>OUT</sub> .
4	PG	V <sub>OUT</sub> in regulation signal. Logic low defines when V <sub>OUT</sub> is not in regulation. Must be grounded if not used.
5	GND	GND pin
6	SS	External cap adjusts inrush current. Leave this pin open if not used.
7	ENABLE	V <sub>IN</sub> independent chip enable. TTL and CMOS compatible.
8	DNC	Do not connect this pin to ground or supply. Leave floating.
9, 10	V <sub>IN</sub>	Input supply pin
	EPAD	EPAD must be connected to a copper plane with as many vias as possible for proper electrical and optimal thermal performance.

### Block Diagram

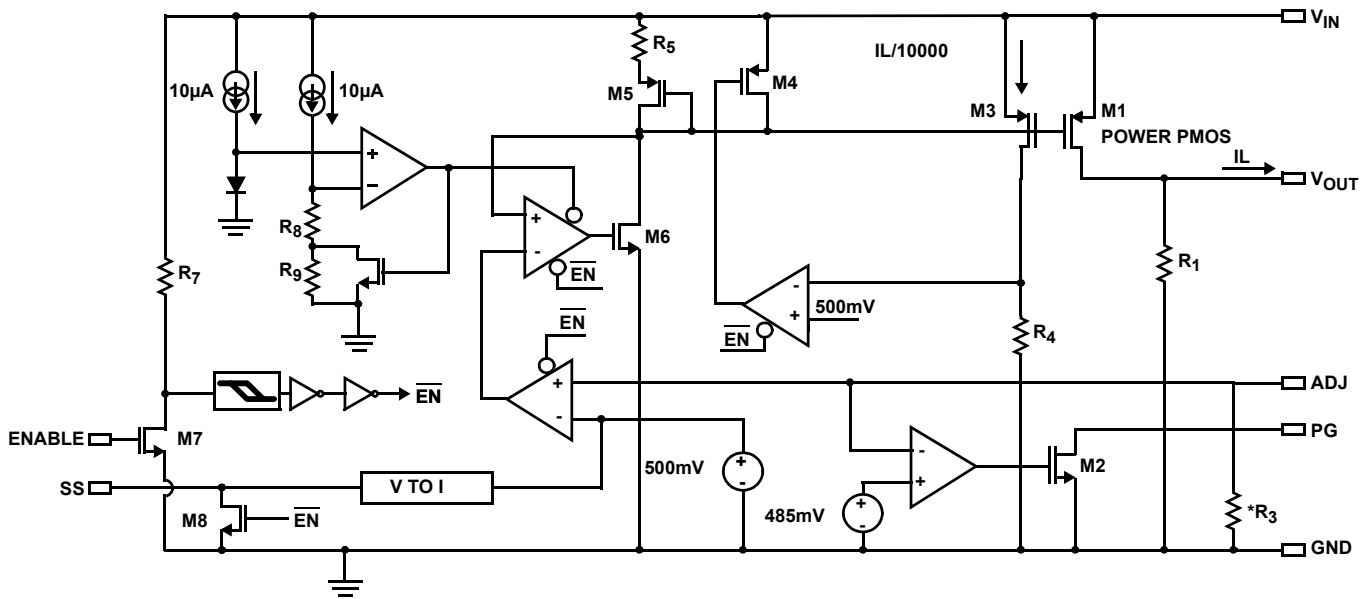

\*R<sub>3</sub> is open for ADJ versions.

FIGURE 2. BLOCK DIAGRAM

## Ordering Information

PART NUMBER (Notes 2, 4, 4)	PART MARKING	V <sub>OUT</sub> VOLTAGE	TEMP. RANGE (°C)	TAPE AND REEL (Units) (Note 1)	PACKAGE (RoHS COMPLIANT)	PKG DWG. #
ISL80102IRAJZ	DZJA	ADJ	-40 to +125	-	10 Ld 3x3 DFN	L10.3x3
ISL80102IRAJZ-T	DZJA	ADJ	-40 to +125	6k	10 Ld 3x3 DFN	L10.3x3
ISL80102IRAJZ-TK	DZJA	ADJ	-40 to +125	1k	10 Ld 3x3 DFN	L10.3x3
ISL80102IRAJZ-T7A	DZJA	ADJ	-40 to +125	250	10 Ld 3x3 DFN	L10.3x3
ISL80103IRAJZ	DZAA	ADJ	-40 to +125	-	10 Ld 3x3 DFN	L10.3x3
ISL80103IRAJZ-T	DZAA	ADJ	-40 to +125	6k	10 Ld 3x3 DFN	L10.3x3
ISL80103IRAJZ-TK	DZAA	ADJ	-40 to +125	4k	10 Ld 3x3 DFN	L10.3x3
ISL80103IRAJZ-T7A	DZAA	ADJ	-40 to +125	250	10 Ld 3x3 DFN	L10.3x3
ISL80102EVAL2Z	Evaluation Board					
ISL80103EVAL2Z	Evaluation Board					

## NOTES:

- See [TB347](#) for details about reel specifications.
- These Pb-free plastic packaged products employ special Pb-free material sets, molding compounds/die attach materials, and 100% matte tin plate plus anneal (e3 termination finish, which is RoHS compliant and compatible with both SnPb and Pb-free soldering operations). Pb-free products are MSL classified at Pb-free peak reflow temperatures that meet or exceed the Pb-free requirements of IPC/JEDEC J STD-020.
- For Moisture Sensitivity Level (MSL), see the [ISL80102](#) and [ISL80103](#) product information pages. For more information about MSL, see [TB363](#).

**Absolute Maximum Ratings** (Note 8)

$V_{IN}$ Relative to GND	-0.3V to +6.5V
$V_{OUT}$ Relative to GND	-0.3V to +6.5V
PG, ENABLE, ADJ, SS, Relative to GND	-0.3V to +6.5V
ESD Rating	
Human Body Model (Tested per JESD22 A114F)	2.2kV
Charge Device Model (Tested per JESD22-C101C)	1kV
Latch-up (Tested per JESD78C, Class 2, Level A)	$\pm 100$ mA at +85°C

**Thermal Information**

Thermal Resistance (Typical)	$\theta_{JA}$ (°C/W)	$\theta_{JC}$ (°C/W)
10 Ld 3x3 DFN Package (Notes 5, 6)	45	4
$\theta_{JB}$ at Pin 3 (Note 7)	14.7°C/W	
$\theta_{JB}$ at Pin 5 (Note 7)	8.9°C/W	
Maximum Junction Temperature (Plastic Package)	+150°C	
Storage Temperature Range	-65°C to +150°C	
Pb-Free Reflow Profile	see <a href="#">TB493</a>	

**Recommended Operating Conditions**

Junction Temperature Range ( $T_J$ )	-40°C to +125°C
$V_{IN}$ Relative to GND	2.2V to 6V
$V_{OUT}$ Range	800mV to 5.5V
PG, ENABLE, ADJ, SS Relative to GND	0V to 6V
PG Sink Current	10mA

**CAUTION:** Do not operate at or near the maximum ratings listed for extended periods of time. Exposure to such conditions can adversely impact product reliability and result in failures not covered by warranty.

**NOTES:**

- $\theta_{JA}$  is measured in free air with the component mounted on a high-effective thermal conductivity test board with "direct attach" features. See [TB379](#).
- For  $\theta_{JC}$ , the "case temp" location is the center of the exposed metal pad on the package underside.
- For  $\theta_{JB}$ , the board temperature is taken on the board near the edge of the package, on a copper trace at either lead #3 or lead #5, as applicable. See [TB379](#).
- ABS max voltage rating is defined as the voltage applied for a lifetime average duty cycle above 6V of 1%.

**Electrical Specifications**

Unless otherwise noted, all parameters are established over the following specified conditions:

2.2V <  $V_{IN}$  < 6V,  $V_{OUT}$  = 0.5V,  $T_J$  = +25°C,  $I_{LOAD}$  = 0A. Applications must follow thermal guidelines of the package to determine worst case junction temperature. Refer to "[Functional Description](#)" on page 12 and [TB379](#). **Boldface limits apply across the operating temperature range, -40°C to +125°C.** Pulse load techniques used by ATE to ensure  $T_J = T_A$  defines established limits.

PARAMETER	SYMBOL	TEST CONDITIONS	MIN (Note 9)	TYP	MAX (Note 9)	UNIT
<b>DC CHARACTERISTICS</b>						
DC Output Voltage Accuracy	$V_{OUT}$	2.2V < $V_{IN}$ < 6V; $I_{LOAD}$ = 0A		0.5		%
		2.2V < $V_{IN}$ < 6V; 0A < $I_{LOAD}$ < 3A	<b>-1.8</b>		<b>1.8</b>	%
		2.9V < $V_{IN}$ < 6V; $I_{LOAD}$ = 0A		0.5		%
		2.9V < $V_{IN}$ < 6V; 0A < $I_{LOAD}$ < full load	<b>-1.8</b>		<b>-1.8</b>	%
Feedback Pin	$V_{ADJ}$	0A < $I_{LOAD}$ < full load	<b>491</b>	500	<b>509</b>	mV
DC Input Line Regulation	$(V_{OUT} \text{ Low Line} - V_{OUT} \text{ High Line}) / V_{OUT} \text{ Low Line}$	2.2V < $V_{IN}$ < 3.6V, $V_{OUT}$ = 1.8V	<b>-0.4</b>	0.1	<b>0.4</b>	%
		2.9V < $V_{IN}$ < 6V, $V_{OUT}$ = 2.5V	<b>-0.8</b>	0.1	<b>0.8</b>	%
DC Output Load Regulation	$(V_{OUT} \text{ No Load} - V_{OUT} \text{ High Load}) / V_{OUT} \text{ No Load}$	ISL80103, 0A < $I_{LOAD}$ < 3A, 2.9V < $V_{IN}$ < 6V; $V_{OUT}$ = 2.5V	<b>-0.8</b>	-0.2	<b>0.8</b>	%
		ISL80102, 0A < $I_{LOAD}$ < 2A, 2.9V < $V_{IN}$ < 6V; $V_{OUT}$ = 2.5V	<b>-0.6</b>	-0.2	<b>0.6</b>	%
Feedback Input Current		$V_{ADJ}$ = 0.5V		0.01	<b>1</b>	μA
Ground Pin Current	$I_Q$	$I_{LOAD}$ = 0A, $V_{OUT}$ + 0.4V < $V_{IN}$ < 6V, $V_{OUT}$ = 2.5V		7.5	<b>9</b>	mA
		$I_{LOAD}$ = 3A, $V_{OUT}$ + 0.4V < $V_{IN}$ < 6V, $V_{OUT}$ = 2.5V		8.5	<b>12</b>	mA
Ground Pin Current in Shutdown	$I_{SHDN}$	EN = 0V, $V_{IN}$ = 5V		0.4		μA
		EN = 0V, $V_{IN}$ = 6V		3.3	<b>16.0</b>	μA

**Electrical Specifications** Unless otherwise noted, all parameters are established over the following specified conditions:  $2.2V < V_{IN} < 6V$ ,  $V_{OUT} = 0.5V$ ,  $T_J = +25^\circ C$ ,  $I_{LOAD} = 0A$ . Applications must follow thermal guidelines of the package to determine worst case junction temperature. Refer to “[Functional Description](#)” on page 12 and [TB379](#). **Boldface limits apply across the operating temperature range,  $-40^\circ C$  to  $+125^\circ C$ .** Pulse load techniques used by ATE to ensure  $T_J = T_A$  defines established limits. (Continued)

PARAMETER	SYMBOL	TEST CONDITIONS	MIN (Note 9)	TYP	MAX (Note 9)	UNIT
Dropout Voltage (Note 10)	$V_{DO}$	ISL80103, $I_{LOAD} = 3A$ , $V_{OUT} = 2.5V$		120	<b>185</b>	mV
		ISL80102, $I_{LOAD} = 2A$ , $V_{OUT} = 2.5V$		81	<b>125</b>	mV
		ISL80103, $I_{LOAD} = 3A$ , $V_{OUT} = 5.5V$		120	<b>244</b>	mV
		ISL80102, $I_{LOAD} = 2A$ , $V_{OUT} = 5.5V$		60	<b>121</b>	mV
Output Short-Circuit Current (3A Version)	ISC	ISL80103, $V_{OUT} = 0V$		5.0		A
Output Short-Circuit Current (2A Version)		ISL80102, $V_{OUT} = 0V$		2.8		A
Thermal Shutdown Temperature	TSD			160		$^\circ C$
Thermal Shutdown Hysteresis	TSDn			15		$^\circ C$
<b>AC CHARACTERISTICS</b>						
Input Supply Ripple Rejection	PSRR	$f = 1kHz$ , $I_{LOAD} = 1A$ ; $V_{IN} = 2.2V$		55		dB
		$f = 120Hz$ , $I_{LOAD} = 1A$ ; $V_{IN} = 2.2V$		62		dB
Output Noise Voltage		$V_{IN} = 2.2V$ , $V_{OUT} = 1.8V$ , $I_{LOAD} = 3A$ , $BW = 100Hz < f < 100kHz$		49		$\mu V_{RMS}$
<b>ENABLE PIN CHARACTERISTICS</b>						
Turn-On Threshold	$V_{EN(HIGH)}$	$2.2V < V_{IN} < 6V$	<b>0.616</b>	0.800	<b>0.950</b>	V
Turn-Off Threshold	$V_{EN(LOW)}$	$2.2V < V_{IN} < 6V$	<b>0.463</b>	0.600		V
Hysteresis	$V_{EN(HYS)}$	$2.2V < V_{IN} < 6V$		135		mV
Enable Pin Turn-On Delay	$t_{EN}$	$C_{OUT} = 10\mu F$ , $I_{LOAD} = 1A$		150		$\mu s$
Enable Pin Leakage Current		$V_{IN} = 6V$ , $EN = 3V$			<b>1</b>	$\mu A$
<b>SOFT-START CHARACTERISTICS</b>						
Reset Pull-Down Resistance	RPD			323		$\Omega$
Soft-Start Charge Current	ICHG		<b>-7.0</b>	-4.5	<b>-2.0</b>	$\mu A$
<b>PG PIN CHARACTERISTICS</b>						
$V_{OUT}$ PG Flag Threshold			<b>75</b>	84	<b>92</b>	$\%V_{OUT}$
$V_{OUT}$ PG Flag Hysteresis				4		%
PG Flag Low Voltage		$I_{SINK} = 500\mu A$		47	<b>100</b>	mV
PG Flag Leakage Current		$V_{IN} = 6V$ , $PG = 6V$		0.05	<b>1</b>	$\mu A$

**NOTES:**

9. Compliance to datasheet limits is assured by one or more methods: production test, characterization, and/or design.
10. Dropout is defined by the difference in supply  $V_{IN}$  and  $V_{OUT}$  when the supply produces a 2% drop in  $V_{OUT}$  from its nominal value.
11. Minimum cap of  $10\mu F$  X5R/X7R on  $V_{IN}$  and  $V_{OUT}$  required for stability.
12. If the current limit for inrush current is acceptable in the application, do not use this feature (leave the SS pin open). Use only when large bulk capacitance is required on  $V_{OUT}$  for the application.

# Typical Operating Performance

$I_L = 0A$ .

Unless otherwise noted,  $V_{IN} = 2.2V$ ,  $V_{OUT} = 1.8V$ ,  $C_{IN} = C_{OUT} = 10\mu F$ ,  $T_J = +25^\circ C$ ,

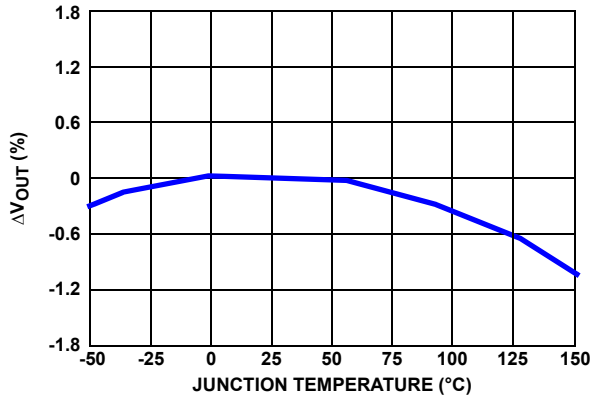

FIGURE 3.  $\Delta V_{OUT}$  vs TEMPERATURE

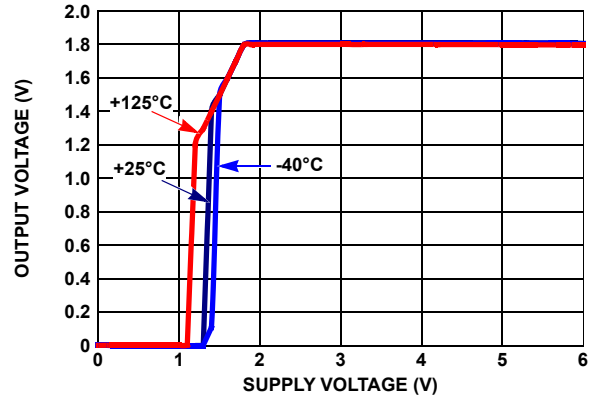

FIGURE 4. OUTPUT VOLTAGE vs SUPPLY VOLTAGE

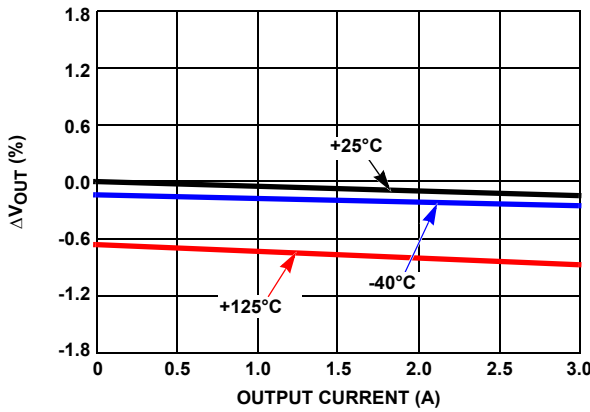

FIGURE 5.  $\Delta V_{OUT}$  vs OUTPUT CURRENT

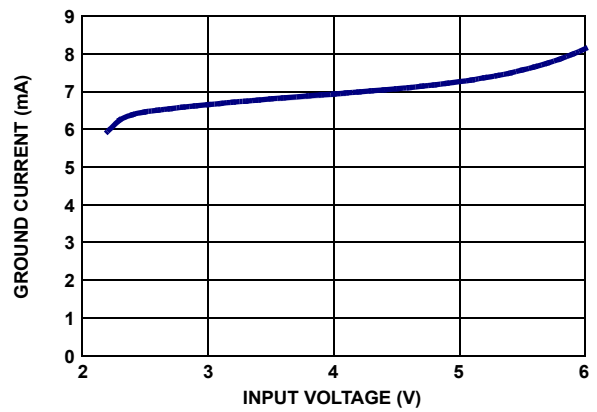

FIGURE 6. GROUND CURRENT vs SUPPLY VOLTAGE

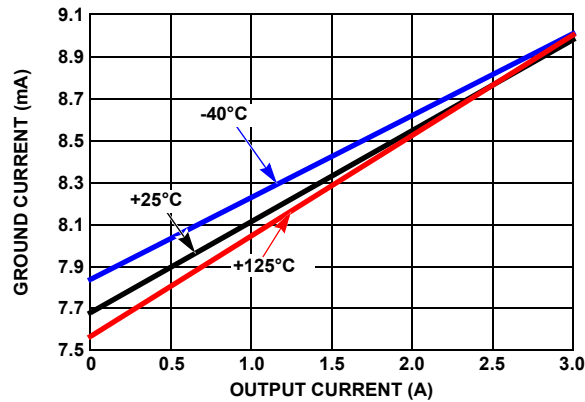

FIGURE 7. GROUND CURRENT vs OUTPUT CURRENT

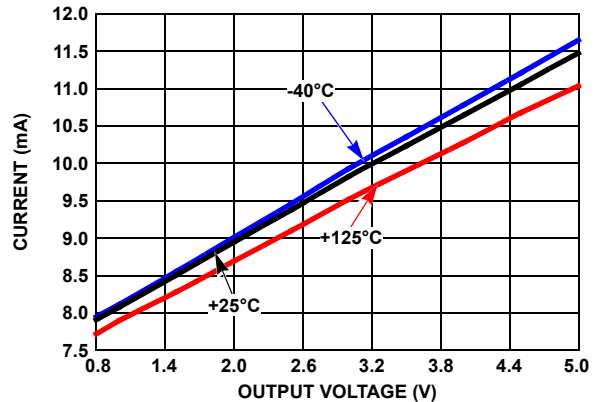

FIGURE 8. GROUND CURRENT vs OUTPUT VOLTAGE ( $V_{IN} = V_{OUT} + V_{DO}$ )

# Typical Operating Performance

Unless otherwise noted,  $V_{IN} = 2.2V$ ,  $V_{OUT} = 1.8V$ ,  $C_{IN} = C_{OUT} = 10\mu F$ ,  $T_J = +25^\circ C$ ,  $I_L = 0A$ . (Continued)

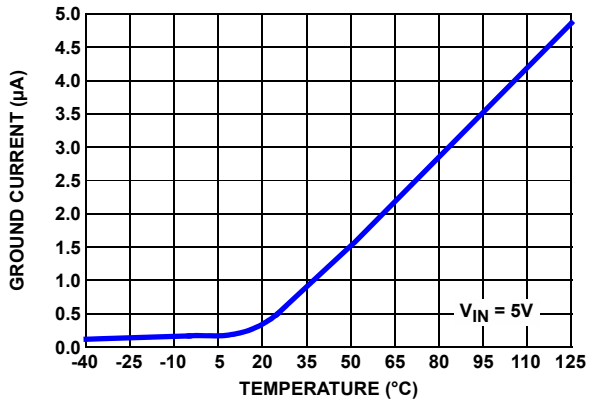

FIGURE 9. GROUND CURRENT IN SHUTDOWN vs TEMPERATURE

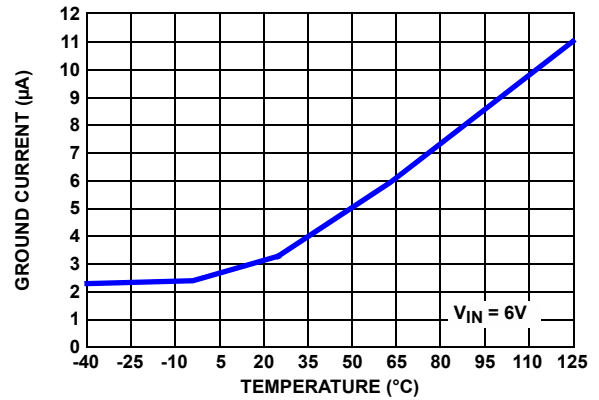

FIGURE 10. GROUND CURRENT IN SHUTDOWN vs TEMPERATURE

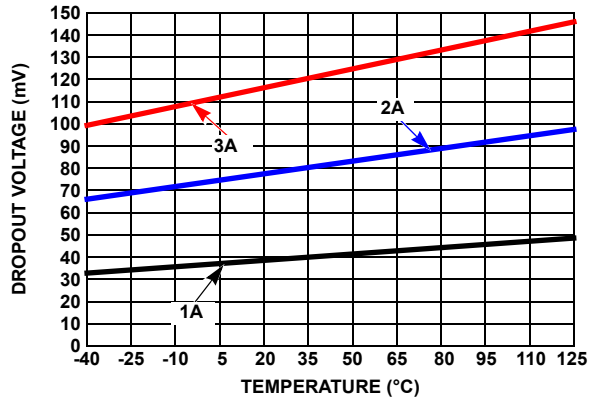

FIGURE 11. DROPOUT VOLTAGE vs TEMPERATURE

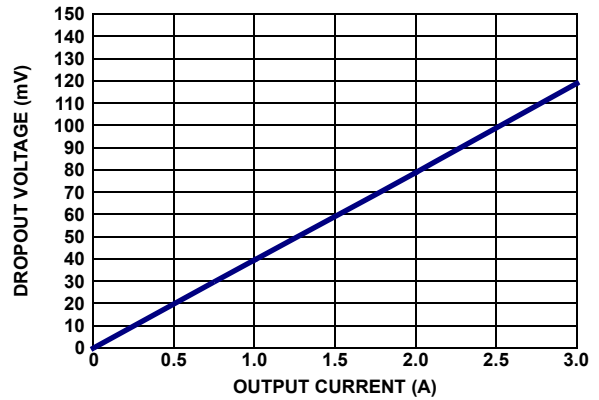

FIGURE 12. DROPOUT VOLTAGE vs OUTPUT CURRENT

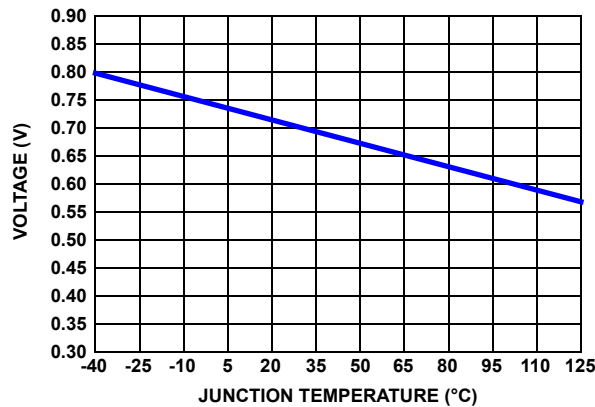

FIGURE 13. ENABLE THRESHOLD VOLTAGE vs TEMPERATURE

# Typical Operating Performance

Unless otherwise noted,  $V_{IN} = 2.2V$ ,  $V_{OUT} = 1.8V$ ,  $C_{IN} = C_{OUT} = 10\mu F$ ,  $T_J = +25^\circ C$ ,  $I_L = 0A$ . (Continued)

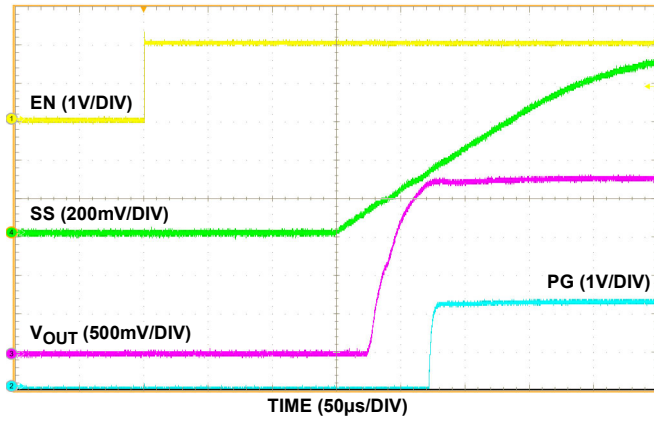

FIGURE 14. ENABLE START-UP SS CAP 1nF

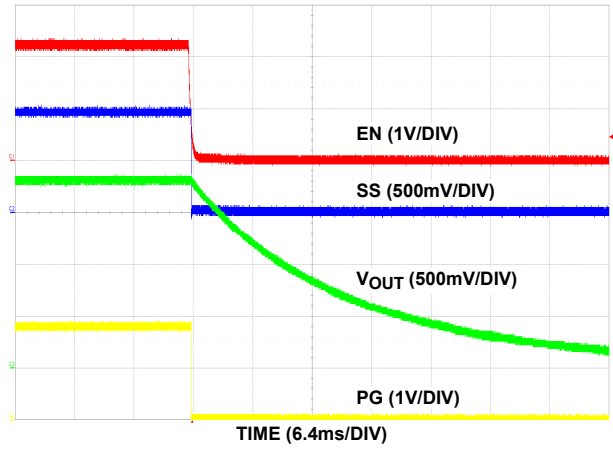

FIGURE 15. ENABLE SHUTDOWN SS CAP 1nF

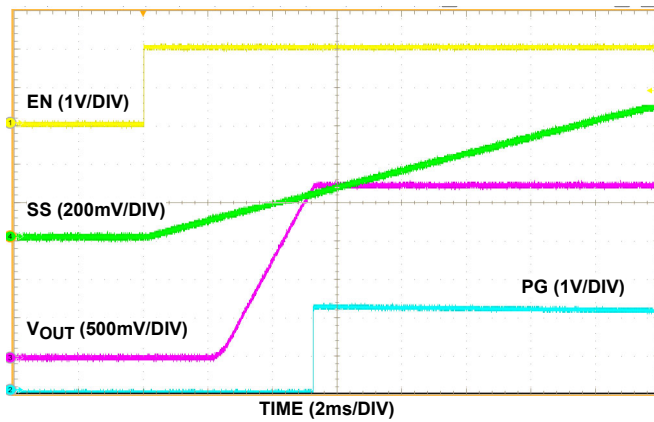

FIGURE 16. ENABLE START-UP SS CAP 100nF

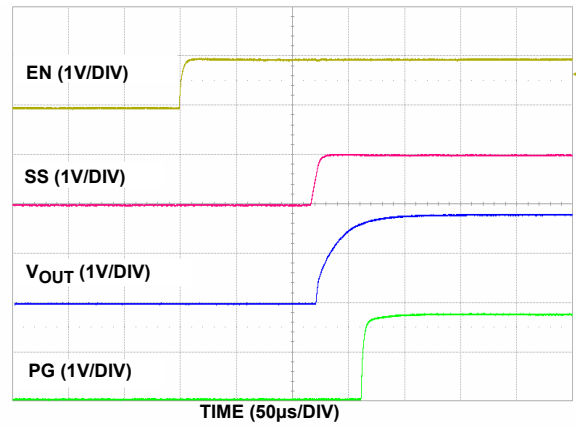

FIGURE 17. ENABLE START-UP (NO SS CAP)

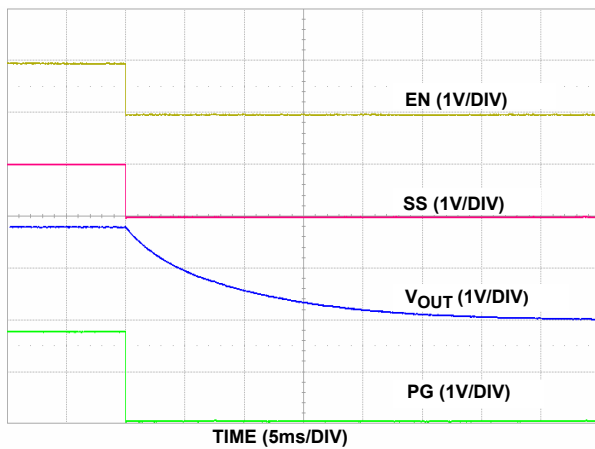

FIGURE 18. ENABLE SHUTDOWN (NO SS CAP)

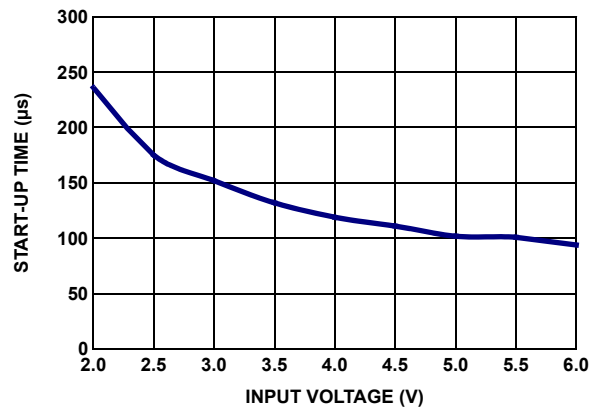

FIGURE 19. START-UP TIME vs SUPPLY VOLTAGE



# Typical Operating Performance

$I_L = 0A$ . (Continued)

Unless otherwise noted,  $V_{IN} = 2.2V$ ,  $V_{OUT} = 1.8V$ ,  $C_{IN} = C_{OUT} = 10\mu F$ ,  $T_J = +25^\circ C$ ,

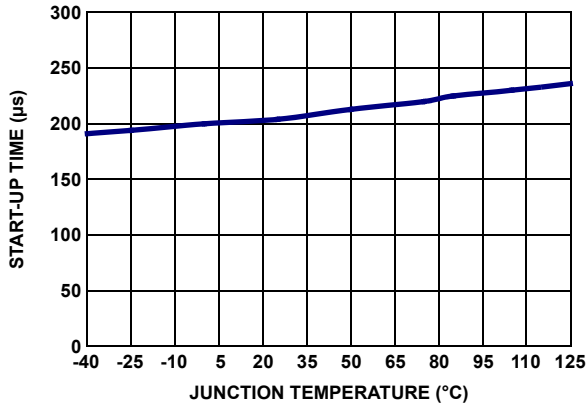

FIGURE 20. START-UP TIME vs TEMPERATURE

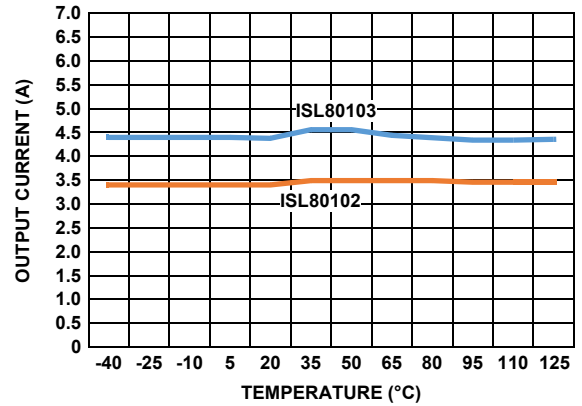

FIGURE 21. CURRENT LIMIT vs TEMPERATURE

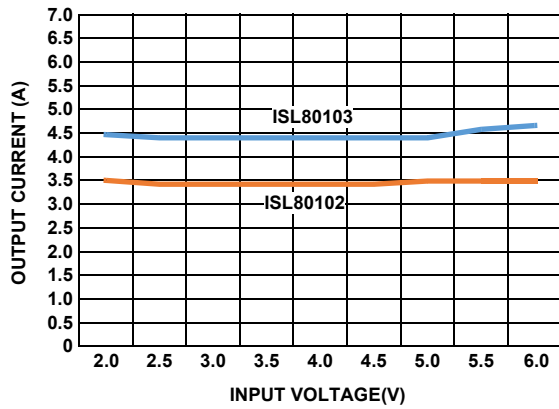

FIGURE 22. CURRENT LIMIT vs SUPPLY VOLTAGE

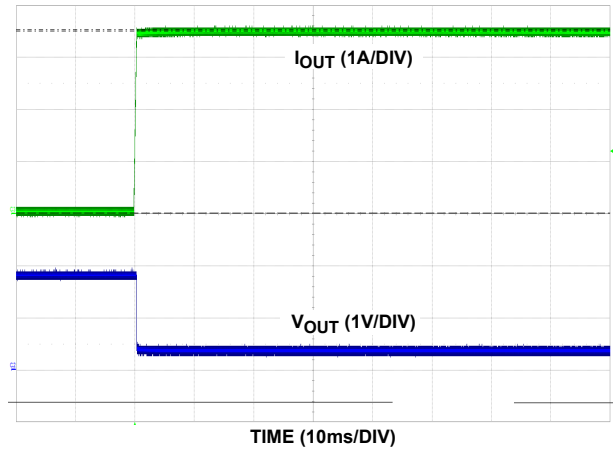

FIGURE 23. CURRENT LIMIT RESPONSE (ISL80102)

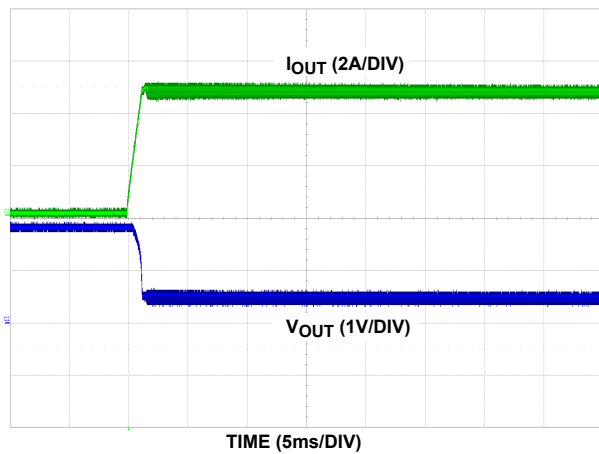

FIGURE 24. CURRENT LIMIT RESPONSE (ISL80103)

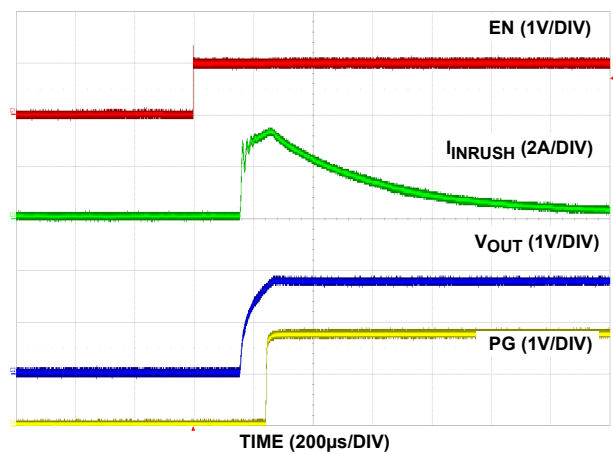

FIGURE 25. INRUSH CURRENT WITH NO SOFT-START CAPACITOR,  $C_{OUT} = 1000\mu F$

# Typical Operating Performance

Unless otherwise noted,  $V_{IN} = 2.2V$ ,  $V_{OUT} = 1.8V$ ,  $C_{IN} = C_{OUT} = 10\mu F$ ,  $T_J = +25^\circ C$ ,  $I_L = 0A$ . (Continued)

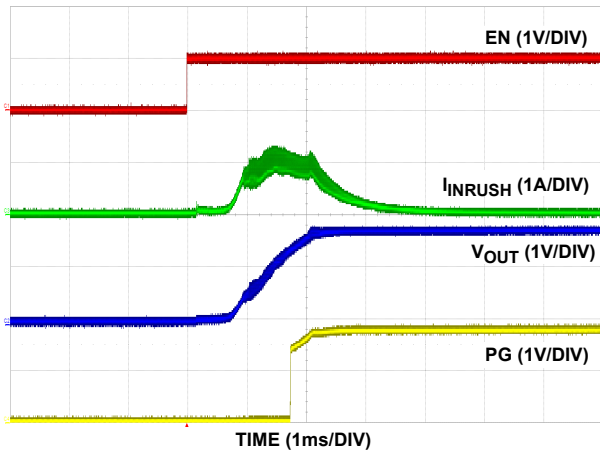

FIGURE 26. INRUSH WITH 22nF SOFT-START CAPACITOR,  $C_{OUT} = 1000\mu F$

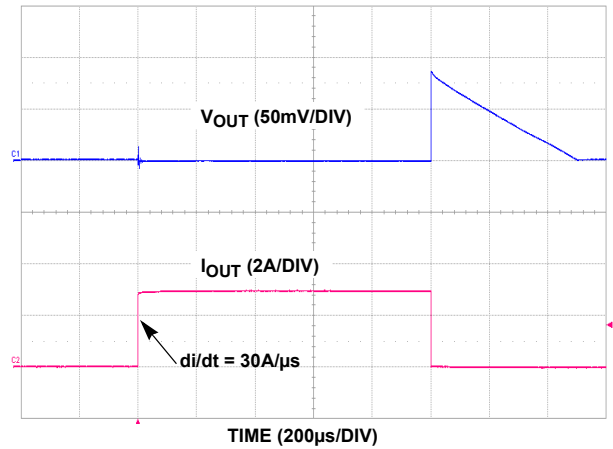

FIGURE 27. LOAD TRANSIENT 0A TO 3A,  $C_{OUT} = 10\mu F$  CERAMIC

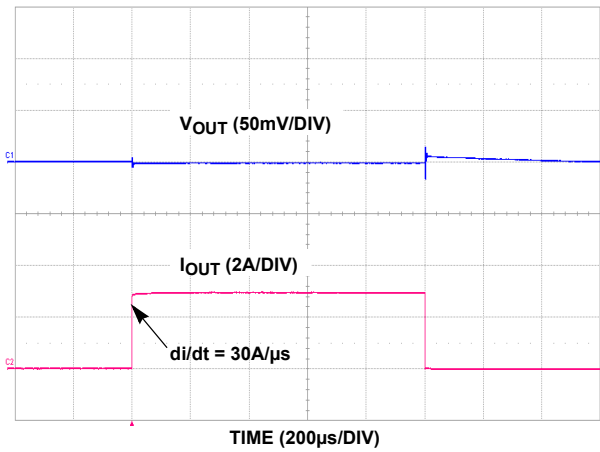

FIGURE 28. LOAD TRANSIENT 0A TO 3A,  $C_{OUT} = 10\mu F$  CERAMIC + 100µF OSCON

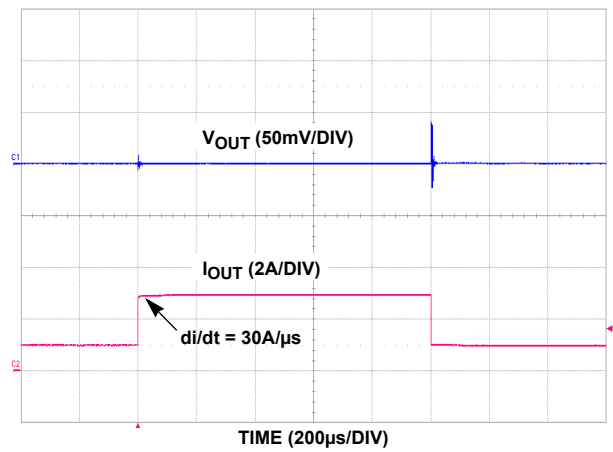

FIGURE 29. LOAD TRANSIENT 1A TO 3A,  $C_{OUT} = 10\mu F$  CERAMIC

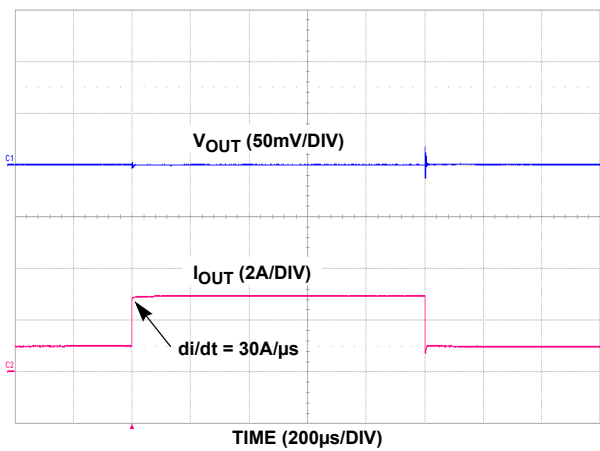

FIGURE 30. LOAD TRANSIENT 1A TO 3A,  $C_{OUT} = 10\mu F$  CERAMIC + 100µF OSCON

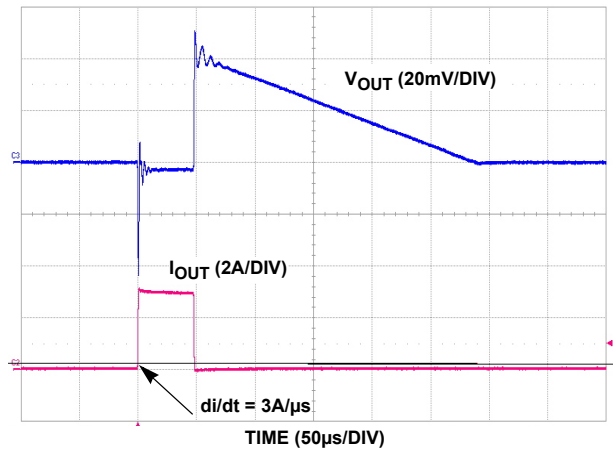

FIGURE 31. LOAD TRANSIENT 0A TO 3A,  $C_{OUT} = 10\mu F$  CERAMIC, NO  $C_{PB}$

# Typical Operating Performance

$I_L = 0A$ . (Continued)

Unless otherwise noted,  $V_{IN} = 2.2V$ ,  $V_{OUT} = 1.8V$ ,  $C_{IN} = C_{OUT} = 10\mu F$ ,  $T_J = +25^\circ C$ ,

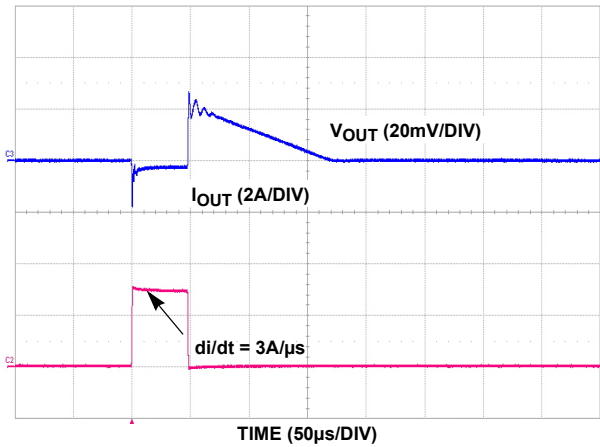

FIGURE 32. LOAD TRANSIENT 0A TO 3A,  $C_{OUT} = 10\mu F$  CERAMIC,  $C_{PB} = 1500pF$

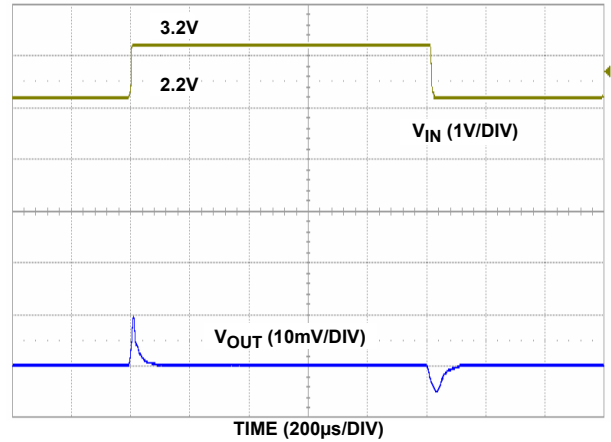

FIGURE 33. LINE TRANSIENT

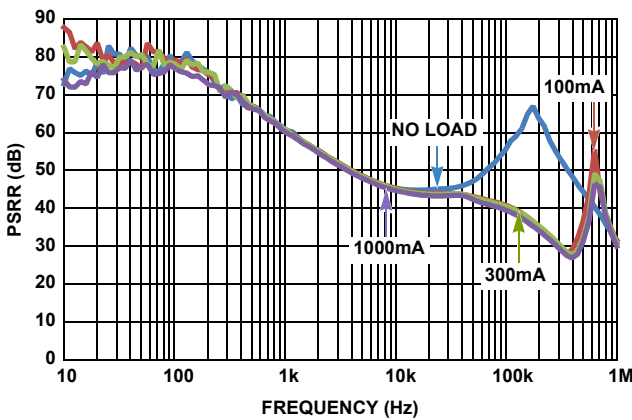

FIGURE 34. PSRR vs FREQUENCY FOR  $V_{OUT} = 1.0V$ ,  $V_{IN} = 2.5V$ ;  $C_{OUT} = 47\mu F$ ,  $C_{PB} = 150pF$

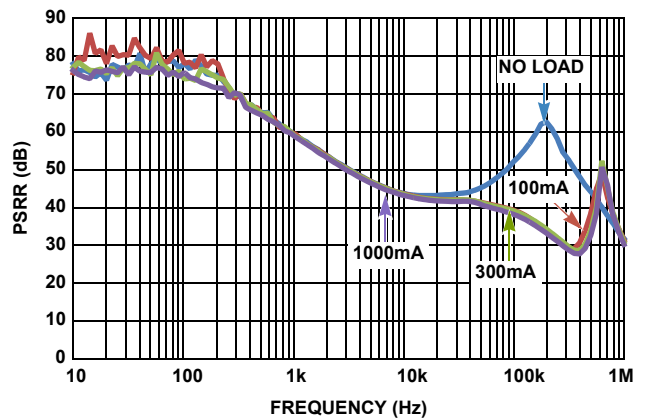

FIGURE 35. PSRR vs FREQUENCY FOR  $V_{OUT} = 1.2V$ ;  $V_{IN} = 2.5V$ ;  $C_{OUT} = 47\mu F$ ,  $C_{PB} = 150pF$

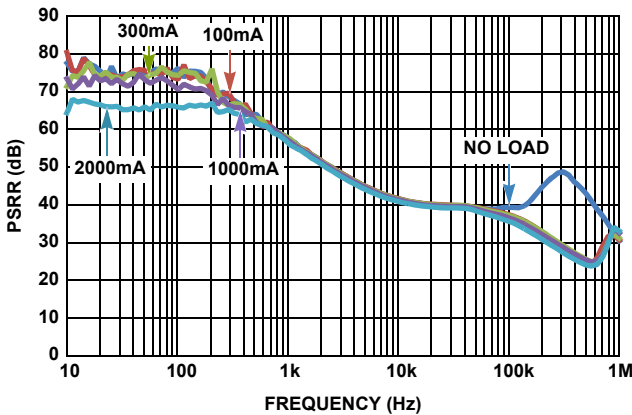

FIGURE 36. PSRR vs FREQUENCY FOR  $V_{OUT} = 1.5V$ ,  $V_{IN} = 2.5V$ ;  $C_{OUT} = 22\mu F$ ,  $C_{PB} = 82pF$

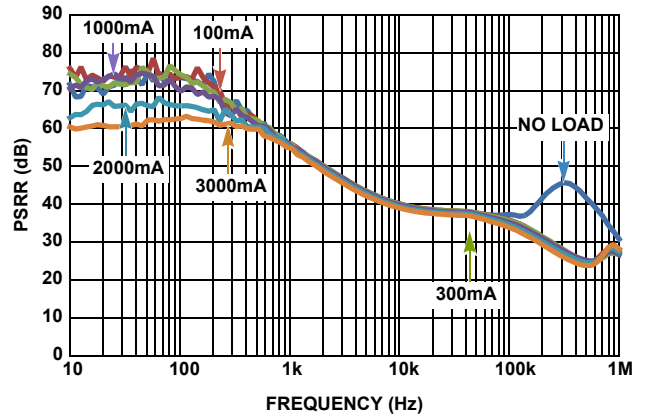

FIGURE 37. PSRR vs FREQUENCY FOR  $V_{OUT} = 1.8V$ ,  $V_{IN} = 2.5V$ ;  $C_{OUT} = 22\mu F$ ,  $C_{PB} = 82pF$

## Typical Operating Performance

$I_L = 0A$ . (Continued)

Unless otherwise noted,  $V_{IN} = 2.2V$ ,  $V_{OUT} = 1.8V$ ,  $C_{IN} = C_{OUT} = 10\mu F$ ,  $T_J = +25^\circ C$ ,

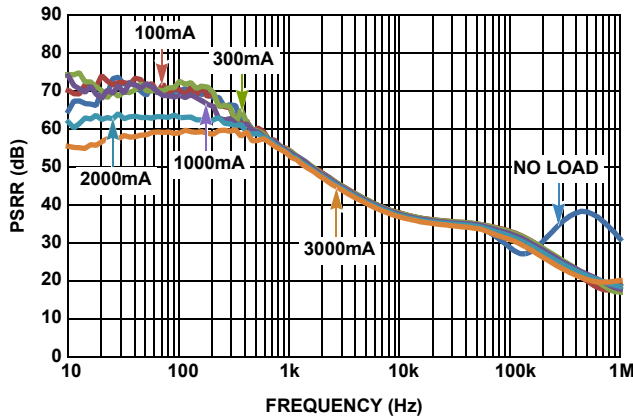

FIGURE 38. PSRR vs FREQUENCY FOR  $V_{OUT} = 2.5V$ ,  $V_{IN} = 3.3V$ ;  $C_{OUT} = 10\mu F$ ,  $C_{PB} = 47pF$

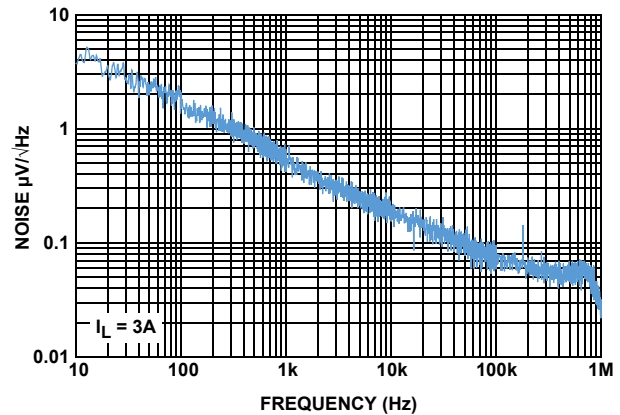

FIGURE 39. SPECTRAL NOISE DENSITY vs FREQUENCY

## Functional Description

### Input Voltage Requirements

This family of LDOs is optimized for a true 2.5V to 1.8V conversion in which the input supply can have a tolerance of as much as  $\pm 10\%$  for conditions noted in the “Electrical Specifications” table on [page 4](#). The minimum guaranteed input voltage is 2.2V; however, due to the nature of an LDO,  $V_{IN}$  must be some margin higher than the output voltage plus dropout at the maximum rated current of the application if active filtering (PSRR) is expected from  $V_{IN}$  to  $V_{OUT}$ . The dropout of this family of LDOs has been generously specified to allow applications to design for a level of efficiency that can accommodate the smaller outline package.

### Enable Operation

The Enable turn-on threshold is typically 800mV with a hysteresis of 135mV. This pin must not be left floating. This pin must be tied to  $V_{IN}$  if it is not used. A 1k $\Omega$  to 10k $\Omega$  pull-up resistor is required for applications that use open collector or open drain outputs to control the Enable pin. The Enable pin can be connected directly to  $V_{IN}$  for applications that are always on.

### Power-Good Operation

Applications not using the power-good (PGOOD) feature must connect this pin to ground. The PGOOD flag is an open-drain NMOS that can sink up to 10mA during a fault condition. The PGOOD pin requires an external pull-up resistor, which is typically connected to the  $V_{OUT}$  pin. The PGOOD pin should not be pulled up to a voltage source greater than  $V_{IN}$ . PGOOD faults can be caused by the output voltage going below 84% of the nominal output voltage, or the current limit fault, or low input voltage. PGOOD does not function during thermal shutdown.

### Soft-Start Operation (Optional)

If the current limit for inrush current is acceptable in the application, do not use the soft-start (SS) feature (leave the SS pin open). The soft-start circuit controls the rate at which the output voltage comes up to regulation at power-up or LDO enable. The external soft-start capacitor always gets discharged to ground pin potential at the beginning of start-up or enabling. After the capacitor discharges, it will immediately begin charging by a constant current source. The discharge rate is the RC time constant of  $R_{PD}$  and  $C_{SS}$ . Refer to [Figures 14](#) through [18](#) in the “Typical Operating Performance Curves” beginning on [page 8](#).  $R_{PD}$  is the ON-resistance of the pull-down MOSFET, M8.  $R_{PD}$  is typically 323 $\Omega$ .

The soft-start feature effectively reduces the inrush current at power-up or LDO enable until  $V_{OUT}$  reaches regulation. The in-rush current can be an issue for applications that require large, external bulk capacitances on  $V_{OUT}$  where high levels of charging current can be seen for a significant period of time. The inrush currents can cause  $V_{IN}$  to drop below minimum which could cause  $V_{OUT}$  to shutdown. [Figure 26 on page 10](#) shows the relationship between inrush current and  $C_{SS}$  with a  $C_{OUT}$  of 1000 $\mu F$ .

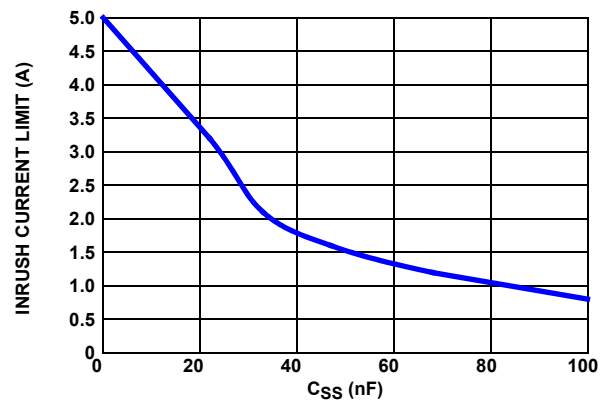

FIGURE 40. INRUSH CURRENT vs SOFT-START CAPACITANCE

## Output Voltage Selection

An external resistor divider scales the output voltage relative to the internal reference voltage. This voltage is then fed back to the error amplifier. The output voltage can be programmed to any level between 0.8V and 5.5V. An external resistor divider,  $R_3$  and  $R_4$ , sets the output voltage as shown in [Equation 1](#). The recommended value for  $R_4$  is 200Ω to 5kΩ.  $R_3$  is then chosen according to [Equation 2](#):

$$V_{OUT} = 0.5V \times \left( \frac{R_3}{R_4} + 1 \right) \quad (\text{EQ. 1})$$

$$R_3 = R_4 \times \left( \frac{V_{OUT}}{0.5V} - 1 \right) \quad (\text{EQ. 2})$$

## External Capacitor Requirements

External capacitors are required for proper operation. To ensure optimal performance, pay careful attention to the layout guidelines and selection of capacitor type and value.

### OUTPUT CAPACITOR

The ISL80102 and ISL80103 apply state-of-the-art internal compensation to keep selection of the output capacitor simple for the customer. Stable operation over full temperature,  $V_{IN}$  range,  $V_{OUT}$  range, and load extremes are guaranteed for all ceramic capacitors and values assuming a 10μF X5R/X7R is used for local bypass on  $V_{OUT}$ . This minimum capacitor (see [Table 1 on page 2](#) for component value selections) must be connected to the  $V_{OUT}$  and ground pins of the LDO with PCB traces no longer than 0.5cm.

Lower cost Y5V and Z5U type ceramic capacitors are acceptable if the size of the capacitor is large enough to compensate for the significantly lower tolerance over X5R/X7R types. Additional capacitors of any value in Ceramic, POSCAP, or Alum/Tantalum Electrolytic types can be placed in parallel to improve PSRR at higher frequencies and/or load transient AC output voltage tolerances.

### INPUT CAPACITOR

The minimum input capacitor required for proper operation is a 10μF with a ceramic dielectric. This minimum capacitor must be connected to  $V_{IN}$  and ground pins of the LDO with PCB traces no longer than 0.5cm.

### Phase Boost Capacitor (Optional)

The ISL80102 and ISL80103 are designed to be stable with 10μF or larger ceramic capacitors.

Applications can see improved performance with the addition of a small ceramic capacitor  $C_{PB}$  as shown in [Figure 1 on page 1](#). The conditions in which  $C_{PB}$  may be beneficial are:

- $V_{OUT} > 1.5V$
- $C_{OUT} = 10\mu F$
- Tight AC voltage regulation band

$C_{PB}$  introduces phase lead with the product of  $R_3$  and  $C_{PB}$  that results in increasing the bandwidth of the LDO. Typical  $R_3 \times C_{PB}$  should be less than 0.4μs (400ns).

## Current Limit Protection

The ISL80102 and ISL80103 family of LDOs incorporates protection against overcurrent due to a short overload condition applied to the output and the inrush current that occurs at start-up. The LDO performs as a constant current source when the output current exceeds the current limit threshold noted in the “Electrical Specifications” table on [page 4](#). If the short or overload condition is removed from  $V_{OUT}$ , then the output returns to normal voltage mode regulation. In the event of an overload condition, the LDO may begin to cycle on and off due to the die temperature exceeding the thermal fault condition.

## Power Dissipation and Thermals

The junction temperature must not exceed the range specified in the “[Recommended Operating Conditions](#)” on [page 4](#). The power dissipation can be calculated by using [Equation 3](#):

$$P_D = (V_{IN} - V_{OUT}) \times I_{OUT} + V_{IN} \times I_{GND} \quad (\text{EQ. 3})$$

The maximum allowable junction temperature,  $T_{J(MAX)}$  and the maximum expected ambient temperature,  $T_{A(MAX)}$  determine the maximum allowable power dissipation as shown in [Equation 4](#):

$$P_{D(MAX)} = (T_{J(MAX)} - T_A) / \theta_{JA} \quad (\text{EQ. 4})$$

where  $\theta_{JA}$  is the junction-to-ambient thermal resistance.

For safe operation, ensure that the power dissipation calculated in [Equation 3](#),  $P_D$ , is less than the maximum allowable power dissipation  $P_{D(MAX)}$ .

The DFN package uses the copper area on the PCB as a heatsink. The EPAD of this package must be soldered to the copper plane (GND plane) for heat sinking. [Figure 41](#) shows a curve for the  $\theta_{JA}$  of the DFN package for different copper area sizes.

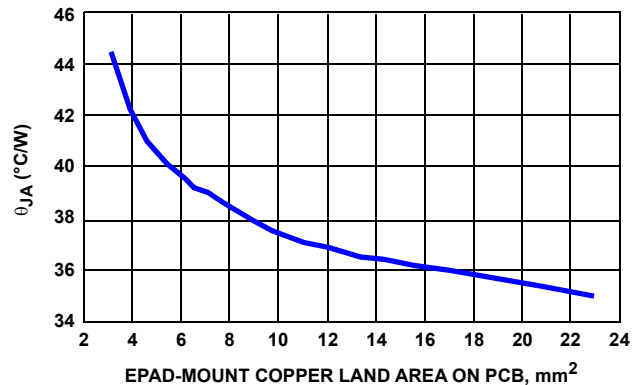

FIGURE 41. 3mmx3mm-10 PIN DFN ON 4-LAYER PCB WITH THERMAL VIAS  $\theta_{JA}$  vs EPAD-MOUNT COPPER LAND AREA ON PCB

## Thermal Fault Protection

If the die temperature exceeds typically +160°C, the output of the LDO shuts down until the die temperature can cool down to typically +145°C. The level of power combined with the thermal impedance of the package (+48°C/W for DFN) determine if the junction temperature exceeds the thermal shutdown temperature.

## Revision History

The revision history provided is for informational purposes only and is believed to be accurate, but not warranted. Please go to web to make sure you have the latest revision.

DATE	REVISION	CHANGE
Jun 11, 2020	9.02	Updated Ordering Information table by removing retired parts, adding tape and reel info, and updated notes. Removed information throughout the document related to the retired parts. Added Theta JB information.
Dec 3, 2019	9.01	Updated Links throughout. Updated Figures 15 and 17. Updated disclaimer.
Mar 19, 2018	9.00	Added Related Literature section to page 1. Changed values in Output Voltage Selection section on page 13 from "500Ω to 1kΩ" to "200Ω to 5kΩ". Removed About Intersil section and added Renesas disclaimer.
Sep 2, 2016	8.00	Removed Note 8 "Electromigration specification defined as lifetime average junction temperature of +110 °C where max rated DC current = lifetime average current" from Recommended Operating Conditions.
Apr 8, 2016	7.00	Updated Ordering Information table (on page 3), Note 1 to include quantities for tape and reel options. Changed V <sub>OUT</sub> range upper limit from "5V to 5.5V" on page 1, in the "Recommended Operating Conditions (Note 7)" on page 4 and in the "Output Voltage Selection" on page 12 Electrical Spec table test conditions changed from: V <sub>IN</sub> = V <sub>OUT</sub> + 0.4V, V <sub>OUT</sub> = 1.8V, C <sub>IN</sub> = C <sub>OUT</sub> = 10μF, T <sub>J</sub> = +25 °C, I <sub>LOAD</sub> = 0A, to: 2.2V < V <sub>IN</sub> < 6V, V <sub>OUT</sub> = 0.5V, T <sub>J</sub> = +25 °C, I <sub>LOAD</sub> = 0A Changed Test conditions in "Output Noise Voltage" on page 5 from: I <sub>LOAD</sub> = 10mA, BW = 300Hz < f < 300kHz; to: V <sub>IN</sub> = 2.2V, V <sub>OUT</sub> = 1.8V, I <sub>LOAD</sub> = 3A, BW = 100Hz < f < 100kHz and changed TYP from: 100; to: 49 Added two rows to "Dropout Voltage (Note 9)" on page 5 to show parameters for 5.5V V <sub>OUT</sub> conditions. Updated verbiage for "About Intersil" on page 16. Updated POD L10.3x3 to most updated revision with changes as follows: Added missing dimension 0.415 in Typical Recommended land pattern. Shortened the e-pad rectangle on both the recommended land pattern and the package bottom view to line up with the centers of the corner pins. Changed Tiebar note 4, from: Tiebar shown (if present) is a non-functional feature. to: Tiebar shown (if present) is a non-functional feature and may be located on any of the 4 sides (or ends).
May 23, 2013	6.00	Pin Descriptions on page 2, updated EPAD section From: EPAD at ground potential. Soldering it directly to GND plane is optional. To: EPAD must be connected to copper plane with as many vias as possible for proper electrical and optimal thermal performance. Removed obsolete part numbers: ISL80102IR33Z, ISL80102IR50Z, ISL80103IR33Z, ISL80103IR50Z from ordering information table on page 3. Added evaluation boards to ordering information table on page 3: ISL80103IR50Z and ISL80103EVAL2Z. Features on page 1: Removed 5 Ld TO220 and 5 Ld TO263. Input Voltage Requirements on page 12: Removed the sentence "those applications that cannot accommodate the profile of the TO220/TO263".
Jun 14, 2012	5.00	In "Thermal Information" on page 4, corrected θ <sub>JA</sub> from 48 to 45.
Feb 14, 2012	4.00	Increased "VEN(HIGH)" minimum limit from 0.4V to 0.616 and added the "VEN(LOW)" spec for clarity on page 5.
Dec 14, 2011	3.00	Increased "Turn-on Threshold" minimum limit on page 5 from 0.3V to 0.4V. Updated "Package Outline Drawing" on page 16 as follows: Removed package outline and included center to center distance between lands on recommended land pattern. Removed Note 4 "Dimension b applies to the metallized terminal and is measured between 0.18mm and 0.30mm from the terminal tip." since it is not applicable to this package. Renumbered notes accordingly.
Mar 4, 2011	2.00	Converted to new template On page 1 - first paragraph, changed "Fixed output voltage options are available in 1.5V, 1.8V, 2.5V, 3.3V and 5V" to "Fixed output voltage options are available in 1.8V, 2.5V, 3.3V and 5V" In "Ordering Information" table on page 2, removed ISL80102IR15Z and ISL80103IR15Z. In Note 3 on page 2, below the "Ordering Information" table, removed '1.5V', so it reads "The 3.3V and 5V fixed output voltages will be released in the future. Please contact Intersil Marketing for more details."

The revision history provided is for informational purposes only and is believed to be accurate, but not warranted. Please go to web to make sure you have the latest revision. (Continued)

DATE	REVISION	CHANGE
Mar 4, 2010	1.00	<p>Corrected Features on page 1 as follows:</p> <ul style="list-style-type: none"> <li>-Changed bullet "• 185mV Dropout @ 3A, 125mV Dropout @ 2A" to "• Very Low 120mV Dropout at 3A"</li> <li>-Changed bullet "• 65dB Typical PSRR" to "• 62dB Typical PSRR"</li> <li>-Deleted 0.5% Initial VOUT Accuracy</li> </ul> <p>Modified Figure 1 and placed as "TYPICAL APPLICATION" on page 1.  Moved Pinout to page 3  In "Block Diagram" on page 2, corrected resistor associated with M5 from R4 to R5  Updated "Block Diagram" on page 2 as follows"  - Added M8 from SS to ground.  Updated Figure 1 on page 1 as follows:  -Corrected Pin 6 from SS to IRSET  -Removed Note 11 callout "Minimum cap on VIN and VOUT required for stability." Added Note "*CSS is optional. See Note 12 on Page 5." and "*** CPB is optional. See "Functional Description" on page 12 for more information."  Added "The 1.5V, 3.3V and 5V fixed output voltages will be released in the future." to Note 3 on page 2.  In "Thermal Information" on page 4, updated Theta JA from 45 to 48.  In "Soft-Start Operation (Optional)" on page 12:  -Changed "The external capacitor always gets discharged to 0V at start-up of after coming out of a chip disable. "The external capacitor always gets discharged to ground pin potential at start-up or enabling."  -Changed "The soft-start function effectively limits the amount of inrush current below the programmed current limit during start-up or an enable sequence to avoid an overcurrent fault condition." to "The soft-start feature effectively reduces the inrush current at power-up or LDO enable until VOUT reaches regulation."  -Added "See Figures 25 through 27 in the "Typical Operating Performance Curves" beginning on page 6."  -Added "RPD is the on resistance of the pull-down MOSFET, M8. RPD is 300Ω typically."  Added "Phase Boost Capacitor (Optional)" on page 13.  In "Typical Operating Performance" on page 11, revised figure "PSRR vs VIN" which had 3 curves with "SPECTRAL NOISE DENSITY vs FREQUENCY" which has one curve.  Added "Figure 33. "LOAD TRANSIENT 0A TO 3A, C<sub>OUT</sub> = 10μF CERAMIC, NO CPB (ADJ VERSION)" and "Figure 34. "LOAD TRANSIENT 0A TO 3A, C<sub>OUT</sub> = 10μF CERAMIC, CPB = 1500pF (ADJ VERSION)"</p>
Sep 30, 2009	0.00	Initial Release.

# Package Outline Drawing

For the most recent package outline drawing, see [L10.3x3](#).

L10.3x3  
 10 LEAD DUAL FLAT PACKAGE (DFN)  
 Rev 11, 3/15

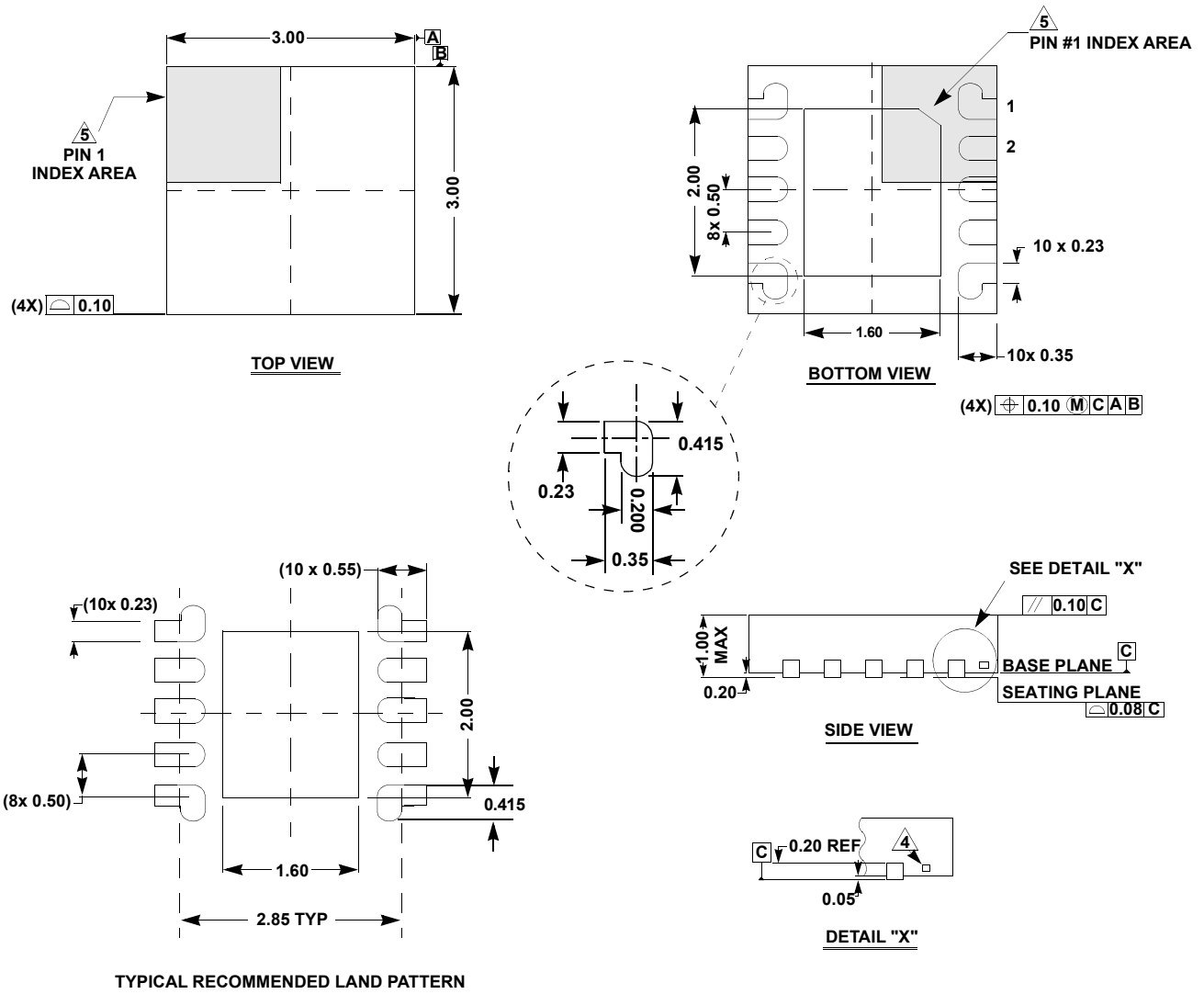

**NOTES:**

1. Dimensions are in millimeters.  
 Dimensions in ( ) for Reference Only.
2. Dimensioning and tolerancing conform to ASME Y14.5m-1994.
3. Unless otherwise specified, tolerance : Decimal ± 0.05
4. Tiebar shown (if present) is a non-functional feature and may be located on any of the 4 sides (or ends).
5. The configuration of the pin #1 identifier is optional, but must be located within the zone indicated. The pin #1 identifier may be either a mold or mark feature.



## IMPORTANT NOTICE AND DISCLAIMER

RENESAS ELECTRONICS CORPORATION AND ITS SUBSIDIARIES (“RENESAS”) PROVIDES TECHNICAL SPECIFICATIONS AND RELIABILITY DATA (INCLUDING DATASHEETS), DESIGN RESOURCES (INCLUDING REFERENCE DESIGNS), APPLICATION OR OTHER DESIGN ADVICE, WEB TOOLS, SAFETY INFORMATION, AND OTHER RESOURCES “AS IS” AND WITH ALL FAULTS, AND DISCLAIMS ALL WARRANTIES, EXPRESS OR IMPLIED, INCLUDING, WITHOUT LIMITATION, ANY IMPLIED WARRANTIES OF MERCHANTABILITY, FITNESS FOR A PARTICULAR PURPOSE, OR NON-INFRINGEMENT OF THIRD PARTY INTELLECTUAL PROPERTY RIGHTS.

These resources are intended for developers skilled in the art designing with Renesas products. You are solely responsible for (1) selecting the appropriate products for your application, (2) designing, validating, and testing your application, and (3) ensuring your application meets applicable standards, and any other safety, security, or other requirements. These resources are subject to change without notice. Renesas grants you permission to use these resources only for development of an application that uses Renesas products. Other reproduction or use of these resources is strictly prohibited. No license is granted to any other Renesas intellectual property or to any third party intellectual property. Renesas disclaims responsibility for, and you will fully indemnify Renesas and its representatives against, any claims, damages, costs, losses, or liabilities arising out of your use of these resources. Renesas' products are provided only subject to Renesas' Terms and Conditions of Sale or other applicable terms agreed to in writing. No use of any Renesas resources expands or otherwise alters any applicable warranties or warranty disclaimers for these products.

(Rev.1.0 Mar 2020)

### Corporate Headquarters

TOYOSU FORESIA, 3-2-24 Toyosu,  
Koto-ku, Tokyo 135-0061, Japan  
[www.renesas.com](http://www.renesas.com)

### Contact Information

For further information on a product, technology, the most up-to-date version of a document, or your nearest sales office, please visit:  
[www.renesas.com/contact/](http://www.renesas.com/contact/)

### Trademarks

Renesas and the Renesas logo are trademarks of Renesas Electronics Corporation. All trademarks and registered trademarks are the property of their respective owners.