

---

# RX610 Group

R01AN0200EJ0100

Rev.1.00

Dec 09, 2010

---

## RIIC Single-Master Communication

### Abstract

This application note presents an example of communication by a single master device using the I<sup>2</sup>C bus interface of a Renesas MCU.

Note: I<sup>2</sup>C bus is a registered trademark of NXP Semiconductors of the Netherlands.

### Introduction

This application note applies to the following MCUs and conditions.

MCUs: RX610 Group

This program can be used with other RX Family MCUs that have the same internal I/O registers (peripheral device control registers) as the RX610 Group. Check the latest version of the manual for any additions and modifications to functions. Careful evaluation is recommended before using this application note.

The program works with an endian specification of big or little and with left or right specified as the bit order.

### Target Device

RX610 Group

### Contents

1. Overview .....	2
2. Connection Diagram.....	3
3. Details .....	4
4. Operation Confirmation Environment.....	13
5. Reference Documents.....	14

## 1. Overview

### 1.1 Functions Used

An overview of the functions used in this application example is shown below.

Single master (7-bit address format)

- Master transmit
- Master receive

Note: For details of the I<sup>2</sup>C bus communication format, see the RX610 Group hardware manual or the I<sup>2</sup>C bus specification.

### 1.2 Operation

First the master transmits data (10 bytes), then it receives data (10 bytes). The communication speed is 100 kbps. The slave address of the device being communicated with is assumed to be 0x20 (including R/W bits). In addition, the address of the master device is 0x10.

## 2. Connection Diagram

Figure 1 is a connection diagram.

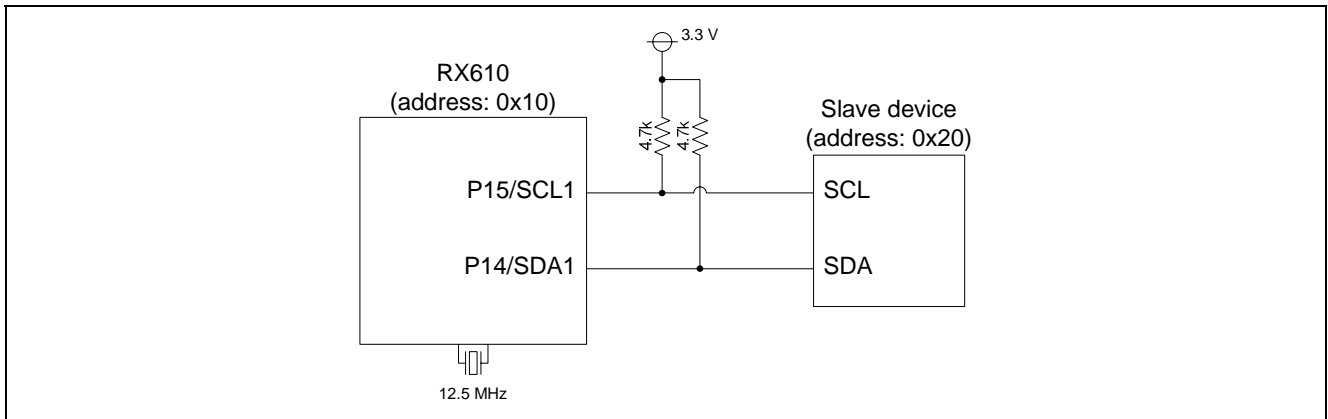

Figure 1 Connection Diagram

3. Details

3.1 Flowcharts

Flowcharts of the application example presented in this document are shown below.

3.1.1 Main Process

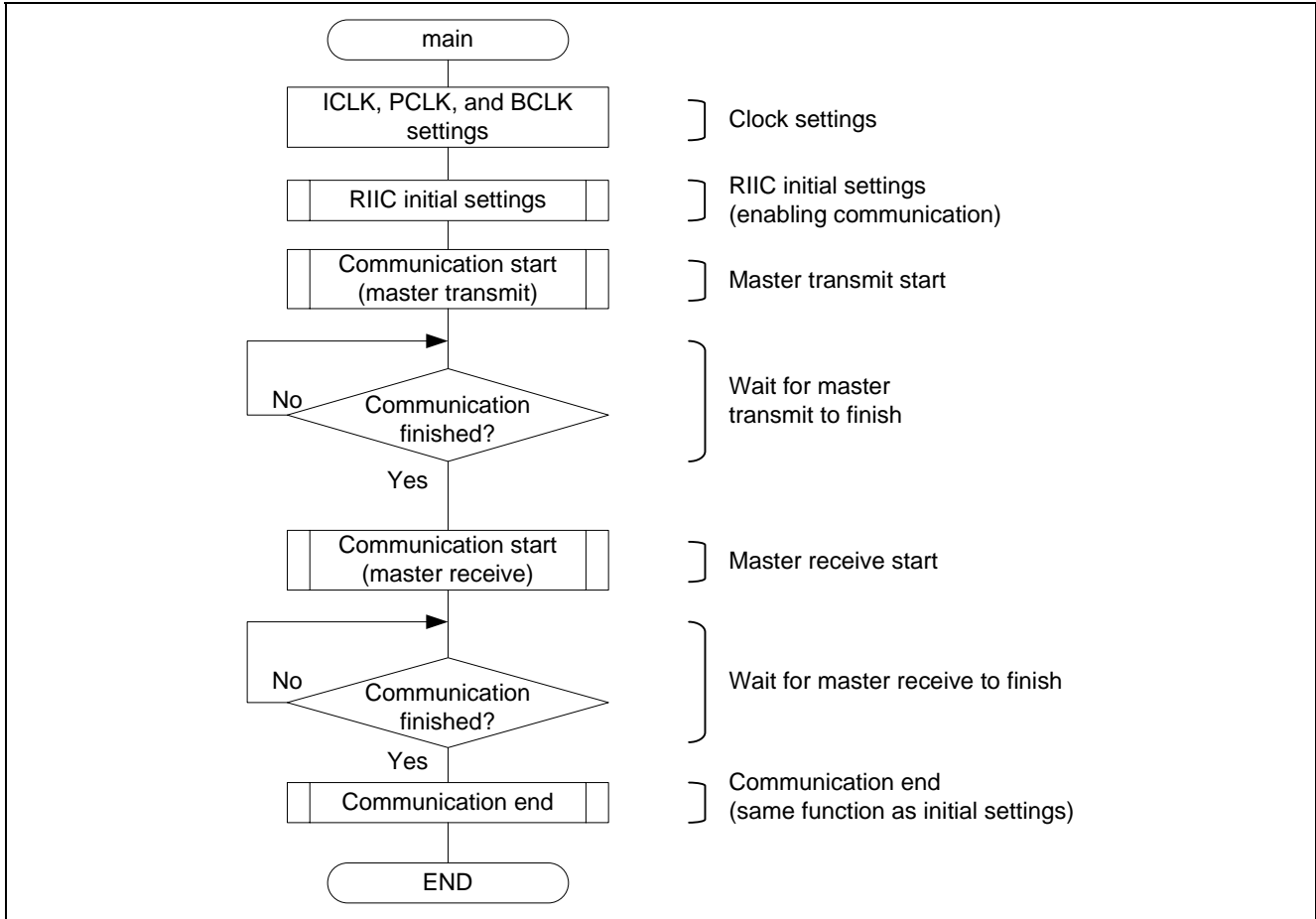

Figure 2 Main Function

3.1.2 RIIC Initial Settings

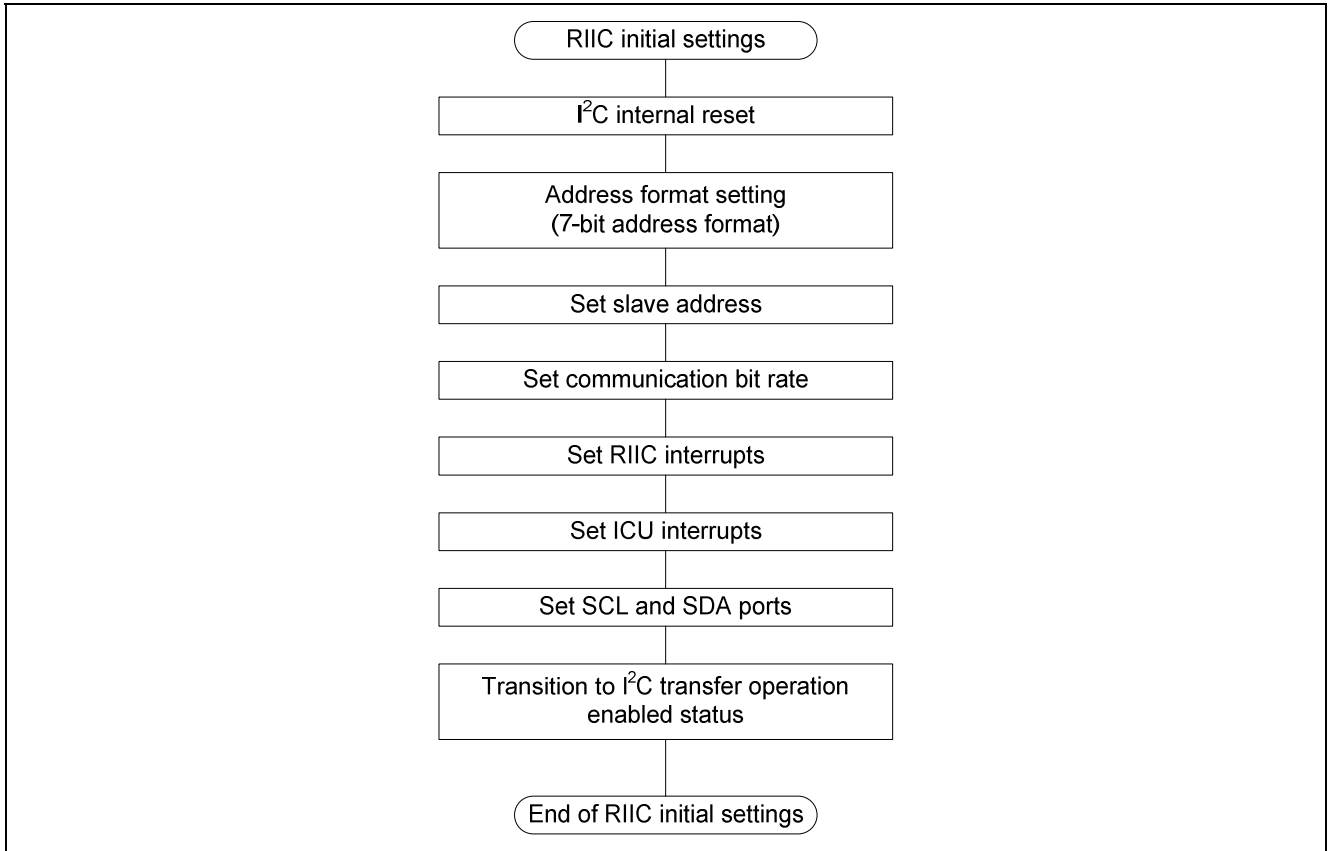

Figure 3 RIIC Initial Settings

3.1.3 Communication Start

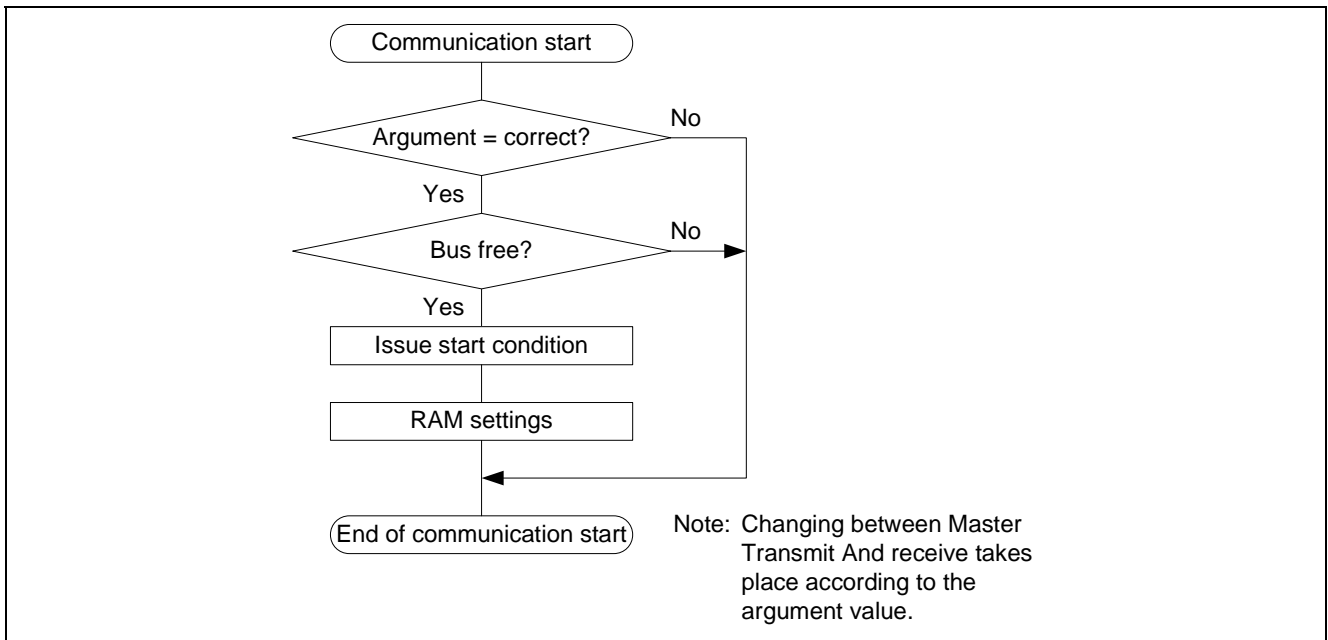

Figure 4 Communication Start

3.1.4 Transmit Data Empty Interrupt

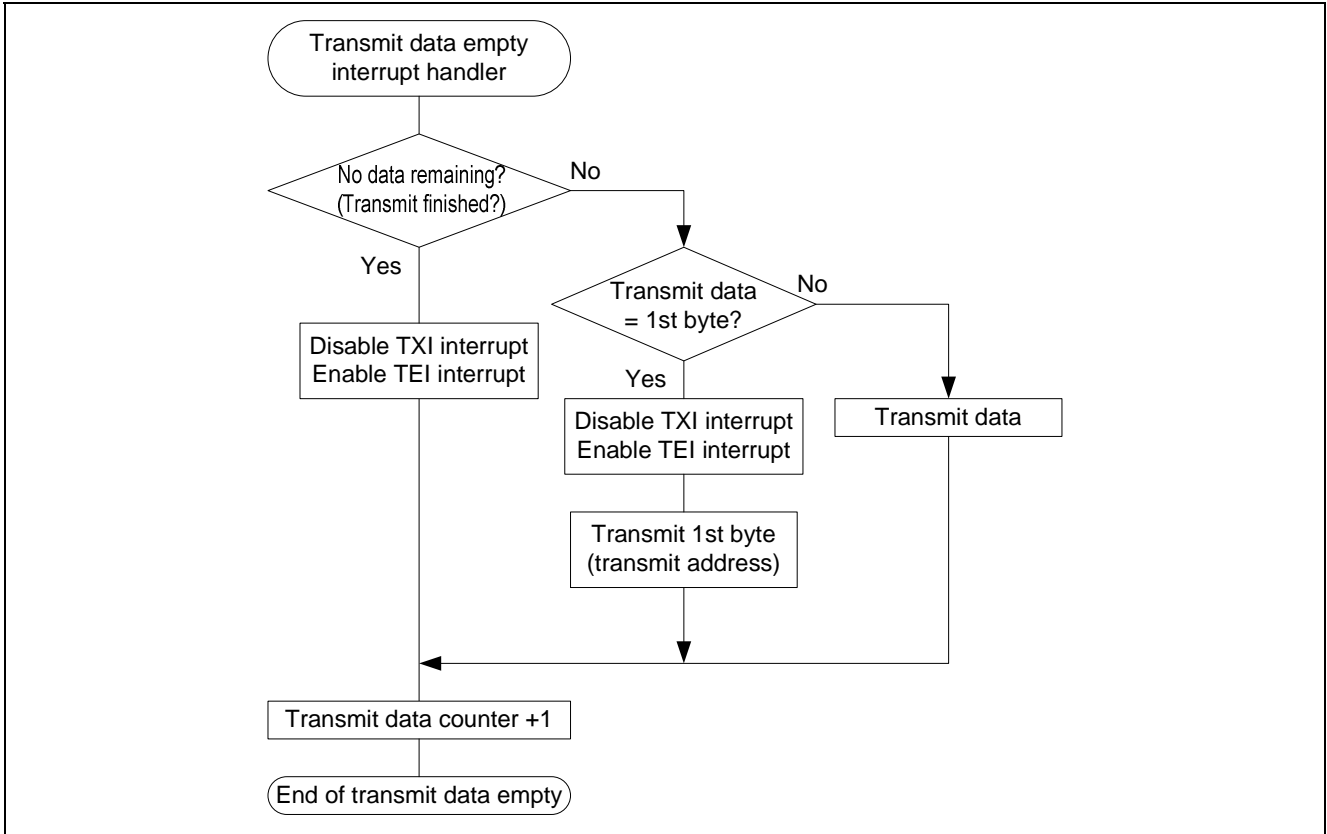

Figure 5 Transmit Data Empty Interrupt

3.1.5 Transmit Finished Interrupt

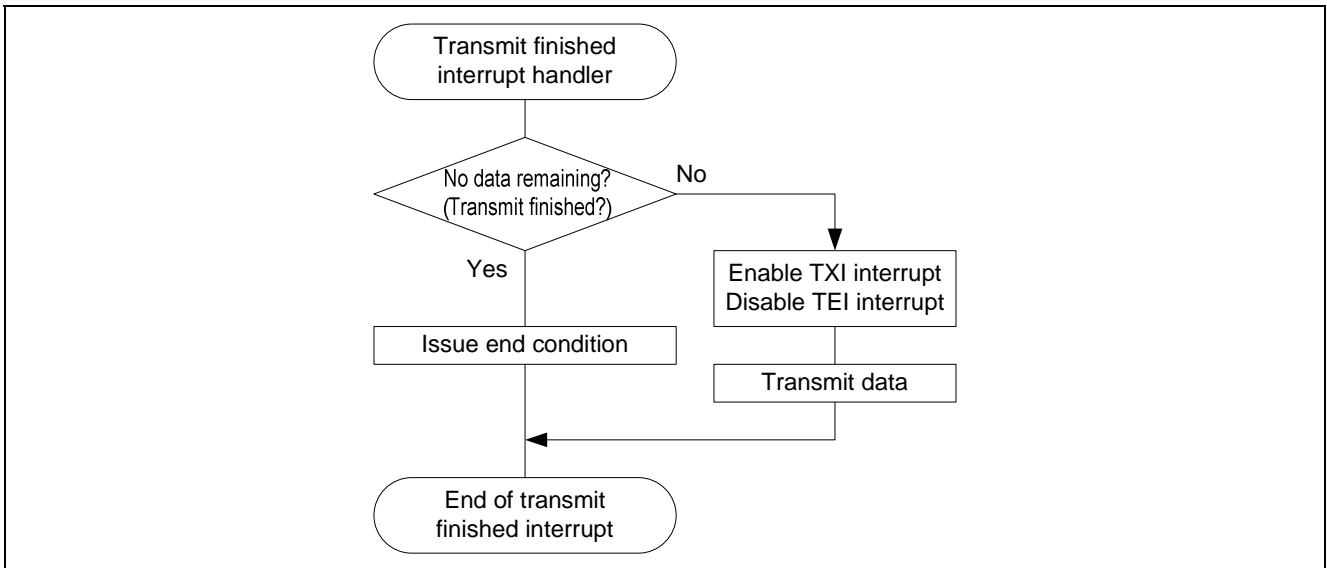

Figure 6 Transmit Finished Interrupt

3.1.6 Receive Data Full Interrupt

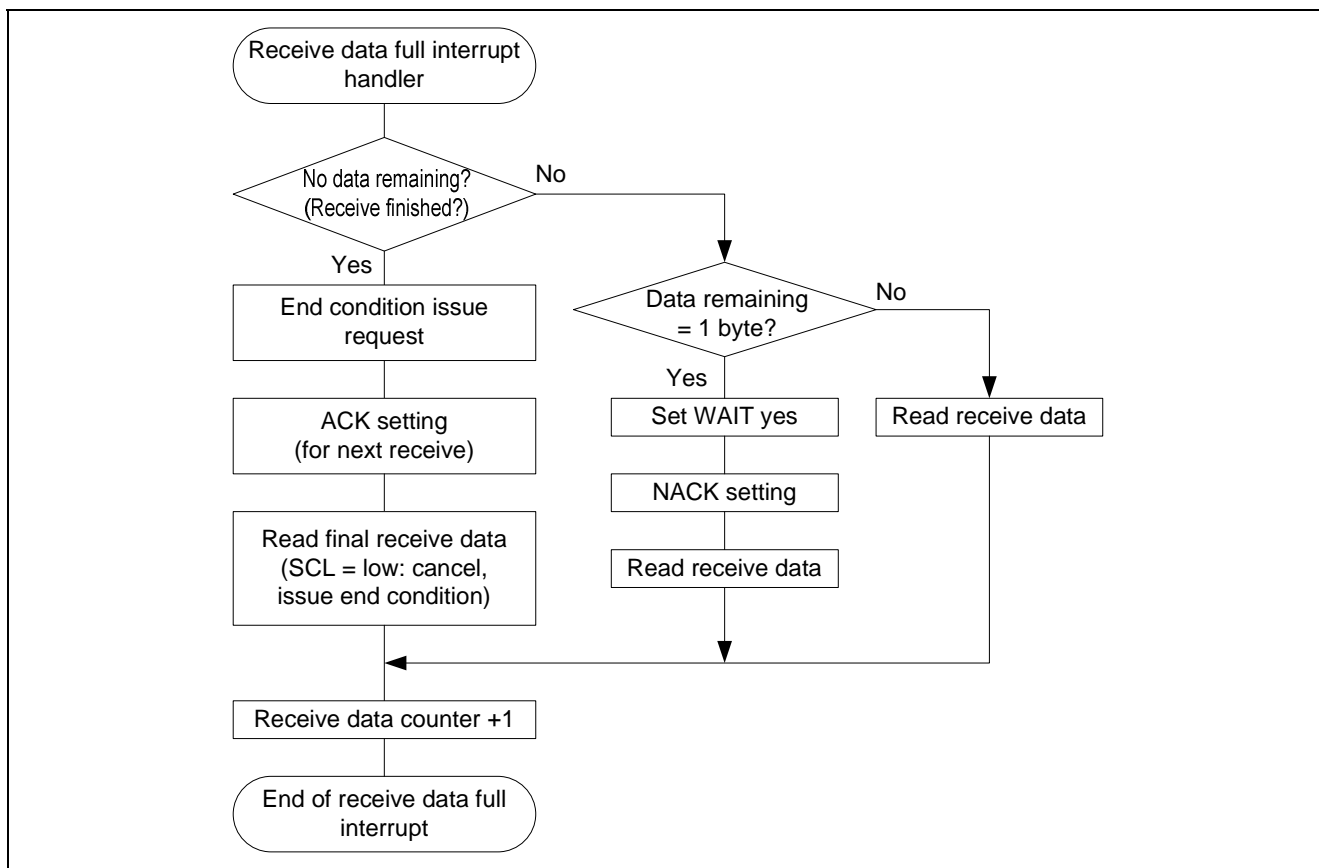

Figure 7 Receive Data Full Interrupt

3.1.7 Communication Error/Event Generation Interrupt

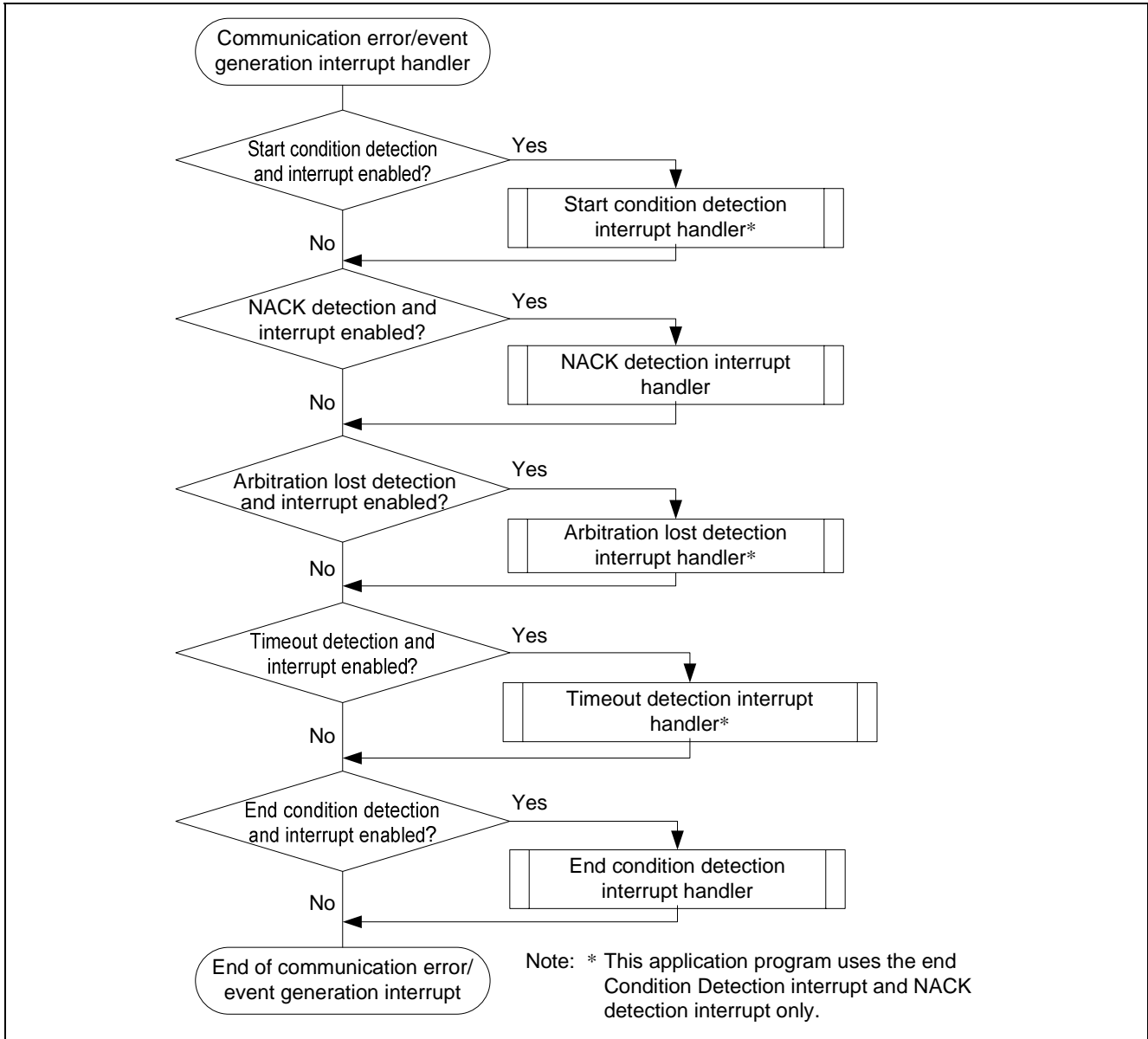

Figure 8 Communication Error/Event Generation Interrupt



3.1.8 End Condition Detection Interrupt

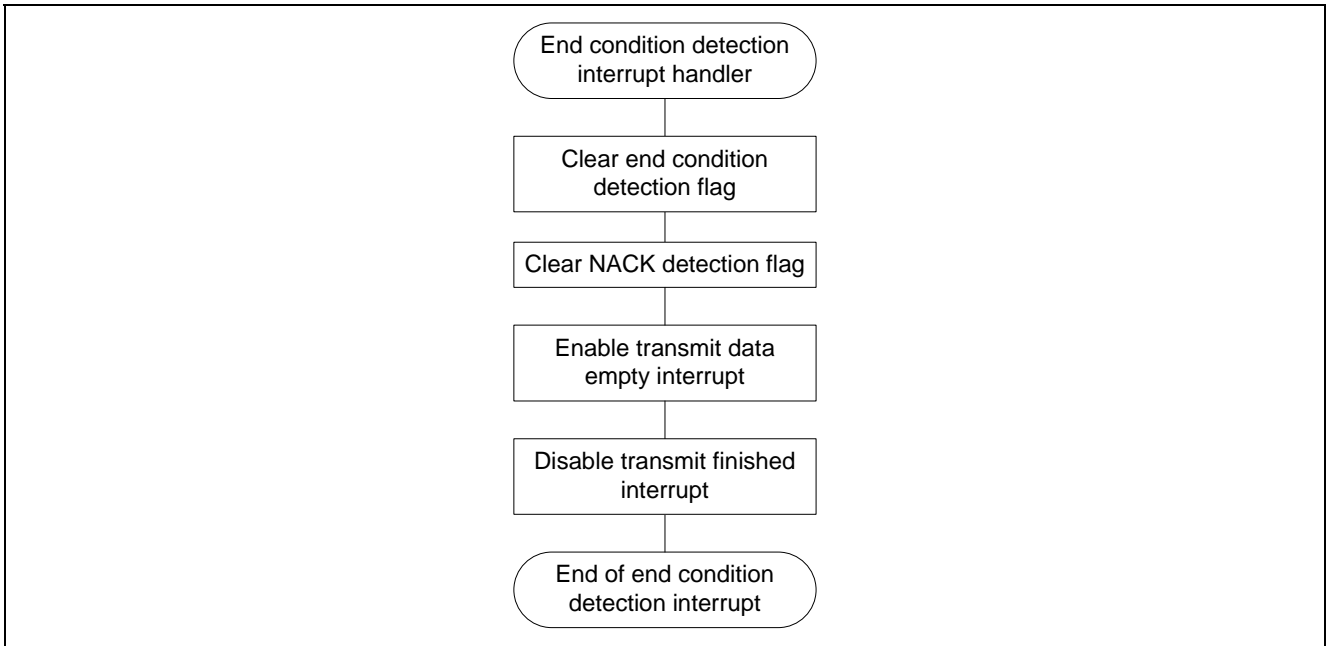

Figure 9 End Condition Detection Interrupt

3.1.9 NACK Detection Interrupt

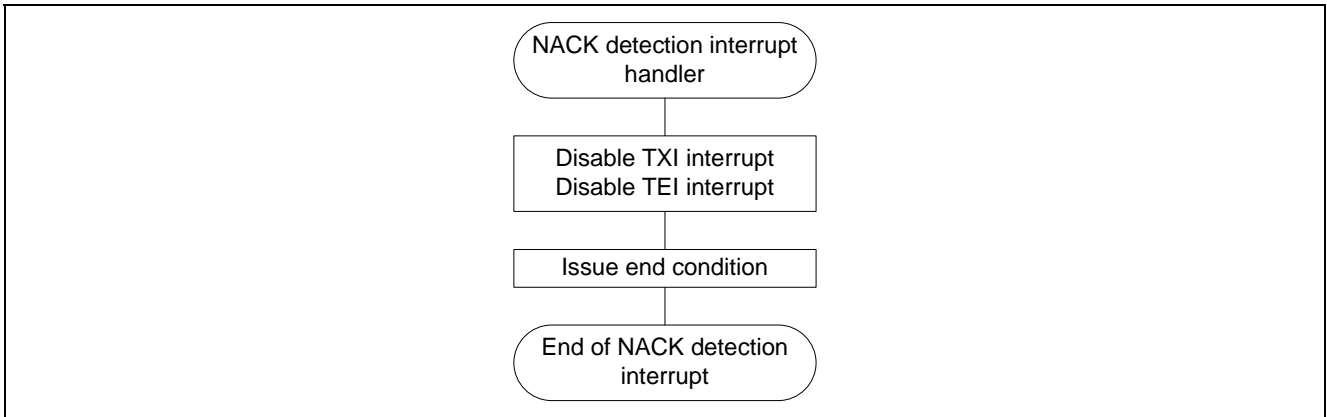

Figure 10 NACK Detection Interrupt

### 3.2 File Structure

Table 1 shows the file structure. In addition to the files listed in table 1, some files generated automatically by HEW are used as well.

**Table 1 File Structure**

File Name	Description
main.c	Main process
riic.c	RIIC control-related process
riic_int.c	RIIC interrupt handler
riic.h	RIIC-related header file (prototype declarations, etc.)
inprg.c	File generated automatically by HEW (Only RIIC interrupt functions used by the sample program have been deleted.)

### 3.3 Function Structure

The specifications of the functions are described below.

**Table 2 List of Functions**

Function Name	File Name	Description
main()	main.c	Main process.
RiicIni()	riic.c	<b>User I/F function.</b> RIIC initial settings. Communication enable/disable settings.
RiicStart()	riic.c	<b>User I/F function.</b> Communication start (master transmit/master receive).
RiicTDRE()	riic.c	Transmit data empty interrupt handler.
RiicTEND()	riic.c	Transmit finished interrupt handler.
RiicRDRF()	riic.c	Receive data full interrupt handler.
RiicSTOP()	riic.c	End condition detection interrupt handler.
RiicNACK()	riic.c	NACK detection interrupt handler.
Excep_RIIC0_EE10 ()	riic_int.c	Functions set for interrupt vectors.
Excep_RIIC0_RX10 ()		Each interrupt calls a corresponding function. The functions called are RiicSTOP(), RiicRDRF(), RiicTDRE(), and RiicTEND().
Excep_RIIC0_TX10 ()		
Excep_RIIC0_TE10 ()		
Excep_RIIC1_EE11 ()		
Excep_RIIC1_RX11 ()		
Excep_RIIC1_TX11 ()		
Excep_RIIC1_TE11 ()		

### 3.3.1 User I/F Functions

- RIIC initial settings function
  - Prototype declarations  
void RiicIni(unsigned char, unsigned char)

— Functions

- RIIC initial settings
- Master (own) address setting
- RIIC communication enable/disable switching

— Arguments

Arguments	Type	Description
1st argument	unsigned char	Master (own) address. (Set the lowest bit to 0.)
2nd argument	unsigned char	0: RIIC communication disabled Other than 0: RIIC communication enabled

— Return values

None

- Communication start function
  - Prototype declarations  
unsigned char RiicStart(unsigned char, unsigned char \*, unsigned long)

— Functions

- RIIC communication start
- Slave address setting of device to be communicated with
- Pointer setting for transmit or receive buffer
- Setting of number of data bytes to be transferred

— Arguments

Arguments	Type	Description
1st argument	unsigned char	Slave address <b>The master transmits</b> when the lowest bit is 0, and <b>the master receives</b> when the lowest bit is 1.
2nd argument	unsigned char*	Storage buffer for data to be transferred During master transmit operation, the data in the buffer indicated by this argument is transmitted. During master receive operation, data is stored in the buffer indicated by this argument. The transmit/receive buffer address is incremented by 1 after each byte of data is transmitted or received.
3rd argument	unsigned long	Transmit/receive data count Specifies the number of bytes of data to be transmitted or received. Also includes the transmitted address.

— Return values

Definition	Value	Description
RIIC_OK	0	Successful finish (communication start)
RIIC_NG	1	Argument error (when transmit/receive data count is less than 2)
RIIC_BUS_BUSY	2	Bus busy

### 3.4 Switching Between Channel 0 and Channel 1

The example application presented in this note uses RIIC channel 1, but this can be switched to channel 0 by changing the `define` declarations in the file `riic.h`. To switch the channel, make the following changes to the `define` declarations.

- To use channel 0:  
Make the `define` declaration for `RIIC_CH0` **valid** and **invalidate** (comment out, etc.) the `define` declaration for `RIIC_CH1`.
- To use channel 1:  
**Invalidate** the `define` declaration for `RIIC_CH0` and make the `define` declaration for `RIIC_CH1` **valid**.

#### 4. Operation Confirmation Environment

Table 3 shows the environment for confirming the operation of the example program.

**Table 3 Operation Confirmation Environment**

Item	Name
Device	RX610 (R5F56108VNFP)
Board	Evaluation board
Power supply voltage	5.0 V (CPU operating voltage: 3.3 V)
Input clock	12.5 MHz (ICLK = 100 MHz, PCLK = 50 MHz, BCLK = 25 MHz)
Operating temperature	Room temperature
HEW	Version 4.07.00.007
Toolchain	RX Standard Toolchain (V.1.0.0.0) RX Family C/C++ Compile Driver V.1.00.00.001 RX Family C/C++ Compiler V.1.00.00.001 RX Family Assembler V.1.00.00.001 Optimizing Linkage Editor V.10.00.00.001 RX Family C/C++ Standard Library Generator V.1.00.00.001
Debugger	RX E20 SYSTEM V.1.00.00.000

## 5. Reference Documents

- Hardware Manual  
RX610 Group Hardware Manual  
(The latest version can be downloaded from the Renesas Electronics Web site.)
- Development Environment Manual  
RX Family C/C++ Compiler Package User's Manual  
(The latest version can be downloaded from the Renesas Electronics Web site.)
- Technical Updates  
(The latest information can be downloaded from the Renesas Electronics Web site.)

**Website and Support**

Renesas Electronics Website

<http://www.renesas.com/>

Inquiries

<http://www.renesas.com/inquiry>

All trademarks and registered trademarks are the property of their respective owners.

## Revision Record

Rev.	Date	Description	
		Page	Summary
1.00	Dec.09.10	—	First edition issued



## General Precautions in the Handling of MPU/MCU Products

The following usage notes are applicable to all MPU/MCU products from Renesas. For detailed usage notes on the products covered by this document, refer to the relevant sections of the document as well as any technical updates that have been issued for the products.

### 1. Handling of Unused Pins

Handle unused pins in accord with the directions given under Handling of Unused Pins in the manual.

- The input pins of CMOS products are generally in the high-impedance state. In operation with an unused pin in the open-circuit state, extra electromagnetic noise is induced in the vicinity of LSI, an associated shoot-through current flows internally, and malfunctions occur due to the false recognition of the pin state as an input signal become possible. Unused pins should be handled as described under Handling of Unused Pins in the manual.

### 2. Processing at Power-on

The state of the product is undefined at the moment when power is supplied.

- The states of internal circuits in the LSI are indeterminate and the states of register settings and pins are undefined at the moment when power is supplied.

In a finished product where the reset signal is applied to the external reset pin, the states of pins are not guaranteed from the moment when power is supplied until the reset process is completed. In a similar way, the states of pins in a product that is reset by an on-chip power-on reset function are not guaranteed from the moment when power is supplied until the power reaches the level at which resetting has been specified.

### 3. Prohibition of Access to Reserved Addresses

Access to reserved addresses is prohibited.

- The reserved addresses are provided for the possible future expansion of functions. Do not access these addresses; the correct operation of LSI is not guaranteed if they are accessed.

### 4. Clock Signals

After applying a reset, only release the reset line after the operating clock signal has become stable. When switching the clock signal during program execution, wait until the target clock signal has stabilized.

- When the clock signal is generated with an external resonator (or from an external oscillator) during a reset, ensure that the reset line is only released after full stabilization of the clock signal. Moreover, when switching to a clock signal produced with an external resonator (or by an external oscillator) while program execution is in progress, wait until the target clock signal is stable.

### 5. Differences between Products

Before changing from one product to another, i.e. to a product with a different part number, confirm that the change will not lead to problems.

- The characteristics of an MPU or MCU in the same group but having a different part number may differ in terms of the internal memory capacity, layout pattern, and other factors, which can affect the ranges of electrical characteristics, such as characteristic values, operating margins, immunity to noise, and amount of radiated noise. When changing to a product with a different part number, implement a system-evaluation test for the given product.

## Notice

1. All information included in this document is current as of the date this document is issued. Such information, however, is subject to change without any prior notice. Before purchasing or using any Renesas Electronics products listed herein, please confirm the latest product information with a Renesas Electronics sales office. Also, please pay regular and careful attention to additional and different information to be disclosed by Renesas Electronics such as that disclosed through our website.
  2. Renesas Electronics does not assume any liability for infringement of patents, copyrights, or other intellectual property rights of third parties by or arising from the use of Renesas Electronics products or technical information described in this document. No license, express, implied or otherwise, is granted hereby under any patents, copyrights or other intellectual property rights of Renesas Electronics or others.
  3. You should not alter, modify, copy, or otherwise misappropriate any Renesas Electronics product, whether in whole or in part.
  4. Descriptions of circuits, software and other related information in this document are provided only to illustrate the operation of semiconductor products and application examples. You are fully responsible for the incorporation of these circuits, software, and information in the design of your equipment. Renesas Electronics assumes no responsibility for any losses incurred by you or third parties arising from the use of these circuits, software, or information.
  5. When exporting the products or technology described in this document, you should comply with the applicable export control laws and regulations and follow the procedures required by such laws and regulations. You should not use Renesas Electronics products or the technology described in this document for any purpose relating to military applications or use by the military, including but not limited to the development of weapons of mass destruction. Renesas Electronics products and technology may not be used for or incorporated into any products or systems whose manufacture, use, or sale is prohibited under any applicable domestic or foreign laws or regulations.
  6. Renesas Electronics has used reasonable care in preparing the information included in this document, but Renesas Electronics does not warrant that such information is error free. Renesas Electronics assumes no liability whatsoever for any damages incurred by you resulting from errors in or omissions from the information included herein.
  7. Renesas Electronics products are classified according to the following three quality grades: "Standard", "High Quality", and "Specific". The recommended applications for each Renesas Electronics product depends on the product's quality grade, as indicated below. You must check the quality grade of each Renesas Electronics product before using it in a particular application. You may not use any Renesas Electronics product for any application categorized as "Specific" without the prior written consent of Renesas Electronics. Further, you may not use any Renesas Electronics product for any application for which it is not intended without the prior written consent of Renesas Electronics. Renesas Electronics shall not be in any way liable for any damages or losses incurred by you or third parties arising from the use of any Renesas Electronics product for an application categorized as "Specific" or for which the product is not intended where you have failed to obtain the prior written consent of Renesas Electronics. The quality grade of each Renesas Electronics product is "Standard" unless otherwise expressly specified in a Renesas Electronics data sheets or data books, etc.  
\*Standard\*: Computers; office equipment; communications equipment; test and measurement equipment; audio and visual equipment; home electronic appliances; machine tools; personal electronic equipment; and industrial robots.  
\*High Quality\*: Transportation equipment (automobiles, trains, ships, etc.); traffic control systems; anti-disaster systems; anti-crime systems; safety equipment; and medical equipment not specifically designed for life support.  
\*Specific\*: Aircraft; aerospace equipment; submersible repeaters; nuclear reactor control systems; medical equipment or systems for life support (e.g. artificial life support devices or systems), surgical implantations, or healthcare intervention (e.g. excision, etc.), and any other applications or purposes that pose a direct threat to human life.
  8. You should use the Renesas Electronics products described in this document within the range specified by Renesas Electronics, especially with respect to the maximum rating, operating supply voltage range, movement power voltage range, heat radiation characteristics, installation and other product characteristics. Renesas Electronics shall have no liability for malfunctions or damages arising out of the use of Renesas Electronics products beyond such specified ranges.
  9. Although Renesas Electronics endeavors to improve the quality and reliability of its products, semiconductor products have specific characteristics such as the occurrence of failure at a certain rate and malfunctions under certain use conditions. Further, Renesas Electronics products are not subject to radiation resistance design. Please be sure to implement safety measures to guard them against the possibility of physical injury, and injury or damage caused by fire in the event of the failure of a Renesas Electronics product, such as safety design for hardware and software including but not limited to redundancy, fire control and malfunction prevention, appropriate treatment for aging degradation or any other appropriate measures. Because the evaluation of microcomputer software alone is very difficult, please evaluate the safety of the final products or system manufactured by you.
  10. Please contact a Renesas Electronics sales office for details as to environmental matters such as the environmental compatibility of each Renesas Electronics product. Please use Renesas Electronics products in compliance with all applicable laws and regulations that regulate the inclusion or use of controlled substances, including without limitation, the EU RoHS Directive. Renesas Electronics assumes no liability for damages or losses occurring as a result of your noncompliance with applicable laws and regulations.
  11. This document may not be reproduced or duplicated, in any form, in whole or in part, without prior written consent of Renesas Electronics.
  12. Please contact a Renesas Electronics sales office if you have any questions regarding the information contained in this document or Renesas Electronics products, or if you have any other inquiries.
- (Note 1) "Renesas Electronics" as used in this document means Renesas Electronics Corporation and also includes its majority-owned subsidiaries.  
(Note 2) "Renesas Electronics product(s)" means any product developed or manufactured by or for Renesas Electronics.



### SALES OFFICES

Renesas Electronics Corporation

<http://www.renesas.com>

Refer to "<http://www.renesas.com/>" for the latest and detailed information.

#### Renesas Electronics America Inc.

2880 Scott Boulevard Santa Clara, CA 95050-2554, U.S.A.  
Tel: +1-408-588-6000, Fax: +1-408-588-6130

#### Renesas Electronics Canada Limited

1101 Nicholson Road, Newmarket, Ontario L3Y 9C3, Canada  
Tel: +1-905-898-5441, Fax: +1-905-898-3220

#### Renesas Electronics Europe Limited

Dukes Meadow, Millboard Road, Bourne End, Buckinghamshire, SL8 5FH, U.K  
Tel: +44-1628-585-100, Fax: +44-1628-585-900

#### Renesas Electronics Europe GmbH

Arcadiastrasse 10, 40472 Düsseldorf, Germany  
Tel: +49-211-65030, Fax: +49-211-6503-1327

#### Renesas Electronics (China) Co., Ltd.

7th Floor, Quantum Plaza, No.27 ZhichunLu Haidian District, Beijing 100083, P.R.China  
Tel: +86-10-8235-1155, Fax: +86-10-8235-7679

#### Renesas Electronics (Shanghai) Co., Ltd.

Unit 204, 205, AZIA Center, No.1233 Lujiazui Ring Rd., Pudong District, Shanghai 200120, China  
Tel: +86-21-5877-1818, Fax: +86-21-6887-7858 / -7898

#### Renesas Electronics Hong Kong Limited

Unit 1601-1613, 16/F., Tower 2, Grand Century Place, 193 Prince Edward Road West, Mongkok, Kowloon, Hong Kong  
Tel: +852-2886-9318, Fax: +852 2886-9022/9044

#### Renesas Electronics Taiwan Co., Ltd.

7F, No. 363 Fu Shing North Road Taipei, Taiwan  
Tel: +886-2-8175-9600, Fax: +886 2-8175-9670

#### Renesas Electronics Singapore Pte. Ltd.

1 HarbourFront Avenue, #06-10, Keppel Bay Tower, Singapore 098632  
Tel: +65-6213-0200, Fax: +65-6278-8001

#### Renesas Electronics Malaysia Sdn.Bhd.

Unit 906, Block B, Menara Amcorp, Amcorp Trade Centre, No. 18, Jln Persiaran Barat, 46050 Petaling Jaya, Selangor Darul Ehsan, Malaysia  
Tel: +60-3-7955-9390, Fax: +60-3-7955-9510

#### Renesas Electronics Korea Co., Ltd.

11F., Samik Lavied' or Bldg., 720-2 Yeoksam-Dong, Kangnam-Ku, Seoul 135-080, Korea  
Tel: +82-2-558-3737, Fax: +82-2-558-5141