

IGBT

R07AN0001EJ0410

Rev.4.10

Jul 13, 2018

IGBT Application Note

Introduction

This application note describes the characteristics and basic usage of the Renesas IGBT based on the content of the information provided on the data sheet.

Contents

1. What is an IGBT?	P2
2. Symbol and terms	P3
2.1. Absolute Maximum Ratings	P3
2.2. Electrical Characteristics	P4
3. Electrical Characteristics	P5
3.1. Collector current, Collector Dissipation	P5
3.2. Safe Operating Area	P6
3.2.1 Forward bias safe operating area	P6
3.2.2 Reverse bias safe operating area	P7
3.3. Static Characteristics	P7
3.4. Capacitance Characteristics	P9
3.4.1. Gate Charge Characteristics	P9
3.4.2. How to determine gate drive current	P10
3.4.3. Drive loss calculation	P10
3.5. Switching Characteristics	P11
3.6. Built-in Diode Characteristics	P13
3.6.1. Built-in diode reverse recovery characteristics	P13
3.6.2. Built-in diode forward voltage characteristics	P14
3.7. Thermal Resistance Characteristics	P15
3.8. Short Circuit Characteristics	P16
4. Maximum Junction Temperature T_{jmax} for 175°C	P17
5. IGBT Losses	P18
5.1. Operating Loss	P18
5.2. Switching Loss	P18

1. What is an IGBT?

IGBT is the acronym for Insulate-gate Bipolar Transistor, a power semiconductor that combines MOSFET high-speed switching, voltage drive characteristics, and the low ON resistance (low saturation voltage) characteristics of a bipolar transistor. As Figure 1 shows IGBT equivalent circuit, a bipolar transistor uses a MOS gate structure, while the equivalent IGBT circuit is a combination of a MOS transistor and a bipolar transistor.

IGBTs, boasting high speed and low saturation voltage characteristics, are used in a wide range of fields, from industrial applications such as solar power conditioning units and uninterruptible power supply (UPS), to consumer applications, such as heat control for IH cooktops, air conditioner PFC, inverters, and camera strobe controllers.

Figure 2 shows a comparison of IGBT, bipolar transistor, and MOSFET structures and features. The basic structure of the IGBT is that of a MOSFET with a p+ layer added to the drain (collector) side, as well as an added pn junction. Therefore, when minority carriers (holes) are injected from the p+ layer to the n- layer with conductivity modulation, the resistance of the n- layer drastically decreases. As a result, the IGBT has a lower saturation voltage (lower ON resistance) than a MOSFET when handling a large current, helping to reduce conduction loss.

However, since the outflow path of holes, the minority carriers accumulated at turn-off, is shut off due to the IGBT structure, a phenomenon called tail current, in which the turn-off is delayed, is generated. When this is generated, the switching time becomes longer than that of the MOSFET and switching time loss at turn-off increases.

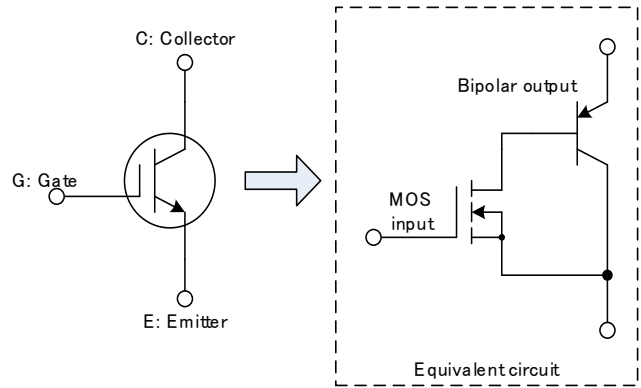

Figure 1. IGBT Equivalent Circuit

		Bipola Transistor	IGBT	Power MOSFET
Structure				
Charact eristics	Carriers	Electrons and holes	Electrons and holes	Electrons only
	Drive capability	High	Low	Low
	High current	○	⊙	×
	Operating frequency	Low	A few KHz~20KHz	Several 10KHz~300KHz

Figure 2. Basic Transistor Structure Comparison

2. Symbol and terms

2.1 Absolute Maximum Ratings

Absolute maximum ratings are rated values set to ensure safe usage of IGBT. Exceeding absolute maximum ratings even instantaneously may lead to deterioration or destruction of the circuit, so please be sure to use IGBTs within the maximum ratings stated here.

Table 1. Absolute Maximum

Name	Symbol	Definition
Collector to Emitter voltage	V_{CES}	Maximum voltage that can be applied between collector and emitter when shorting gate-emitter.
Gate to Emitter voltage	V_{GES}	Maximum voltage that can be applied between gate and emitter when shorting collector-emitter.
Collector current	I_C	Maximum allowable current to collector terminal.
	$I_{C(peak)}$	Maximum allowable current to collector terminal during pulse operation.
Diode forward current	I_F	Maximum allowable current to built-in diode.
	$I_{F(peak)}$	Maximum allowable current to built-in diode during pulse operation.
Collector dissipation	P_C	Maximum allowable power dissipation (loss) occurring at collector-emitter.
Junction-to-case thermal resistance	$R_{th(j-c)}$	Thermal resistance from element junction to case.
Junction temperature	T_j	Maximum allowable temperature range at element junction for normal operations.
Storage temperature	T_{stg}	Temperature range for storage without applied power

Usage Notes

Even if the usage conditions (operating temperature / current / voltage etc.) are within the absolute maximum ratings, if the IGBT is used continuously under high load (high temperature, large current/high voltage application, large temperature change etc.), the reliability may decrease significantly. Please check the Renesas Semiconductor Reliability Handbook (handling precautions, usage notes, requests and derating concepts and methods) and individual reliability data (reliability test reports, estimated failure rates, etc.), and always design for reliability.

2.2 Electrical Characteristics

Table 2. Electrical Characteristics

Name	Symbol	Definition
Collector to Emitter leakage current	I_{CES}	Collector current when gate-emitter is shorted and a specified voltage is applied between collector and emitter.
Gate to Emitter leakage current	I_{GES}	Gate current when collector-emitter is shorted and a specified voltage is applied between gate and emitter.
Gate to Emitter threshold voltage	$V_{GE(th)}$	Gate-emitter voltage at a specified collector current when a specified collector-emitter voltage is applied.
Collector to Emitter saturation voltage	$V_{CE(sat)}$	Gate-emitter voltage at a specified collector current when a specified gate-emitter voltage is applied.
Input capacitance	C_{ies}	Gate-emitter capacitance at a specified gate-emitter voltage, specified collector-emitter voltage, and specified frequency.
Output capacitance	C_{oes}	Collector-emitter capacitance at a specified gate-emitter voltage, specified collector-emitter voltage, and specified frequency.
Reverse transfer capacitance	C_{res}	Gate-collector capacitance at a specified gate-emitter voltage, specified collector-emitter voltage, and specified frequency.
Total Gate charge	Q_g	Charge required to reach specified gate-emitter voltage.
Gate to Emitter charge	Q_{ge}	Charge required for gate-emitter voltage to reach threshold voltage
Gate to Collector charge	Q_{gc}	Additional charge due to gate-collector mirror effect.
Turn-on delay time	$t_{d(on)}$	Time required for collector current to rise to 10% after gate-emitter voltage reaches 10% of its forward bias voltage.
Rise time	t_r	Time for collector current to rise from 10% to 90%.
Turn-off delay time	$t_{d(off)}$	Time required for collector current to fall to 90% after gate-emitter voltage reaches 90% of its forward bias voltage.
Fall time	t_f	Time for collector current to fall from 90% to 10%.
Turn-on energy loss	E_{on}	Integral value of collector energy loss from the start of turn-on until the specified collector-emitter voltage is reached.
Turn-off energy loss	E_{off}	Integral value of collector energy loss from the start of turn-off until the specified collector-emitter voltage is reached.
Total switching energy loss	E_{total}	Total of E_{on} and E_{off} .
Short circuit withstand time	t_{sc}	Time IGBT can withstand short circuiting under specified conditions.
Diode forward voltage	V_F	Emitter-collector voltage at specified diode current.
Diode reverse recovery time	t_{rr}	When the diode current switches from the forward direction to the reverse direction, the period from when the reverse recovery current begins to flow and the point where the straight line connecting 90% and 50% of the reverse recovery current peak value crosses the time axis.
Diode reverse recovery current	I_{rr}	Current flowing in the reverse direction transiently when switching from the state when the diode current is flowing to the off state.
Diode reverse recovery charge	Q_{rr}	Total charge that is disappear during reverse recovery operation.

3. Electrical Characteristics

3.1 Collector current, Collector Dissipation

Figure 3 shows the collector dissipation temperature characteristics of RBN40H125S1FPQ.

The allowable collector dissipation is shown at different case temperatures, and the following equation holds when $T_C = 25^\circ\text{C}$ or more.

$$P_C = \frac{(T_{jmax} - T_C)}{R_{th(j-c)}}$$

If $T_C = 25^\circ\text{C}$ or less, collector dissipation is applied by the absolute maximum rating.

Collector current is specified following formula.

$$I_C = \frac{(T_{jmax} - T_C)}{R_{th(j-c)} \times V_{CE(sat)}}$$

But this is basic formula which are based on thermal calculation. Collector current of products is decided by $V_{CE(sat)}$ of current dependency and temperature dependency.

And collector current (peak) is specified by current capability which are based on assembly factor or reliability. Therefore, please use it in range of the maximum ratings. However even though collector current is below the maximum rating, it might be limited by junction temperature or safe operation area. So please take care it.

Both collector current and collector dissipation are specified maximum ratings. so please be sure to use IGBTs within the maximum ratings.

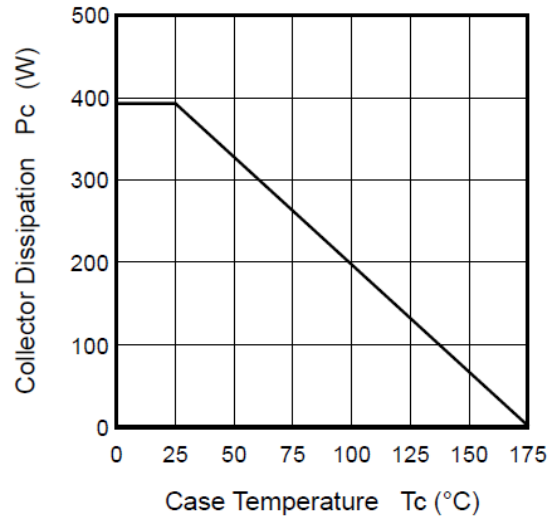

Figure 3. Collector Dissipation vs. Case Temperature

3.2 Safe Operating Area

The safe operating area (SOA) is based on ratings that confirm that the operation locus after the IGBT switching operation is within the specified range of voltage, current and power values. It is necessary to design the circuit so that operation trajectory at both turn-on and turn-off are within the SOA (Figure 4).

There SOA includes a forward bias SOA and a reverse bias SOA, but as the specified range of values may differ according to product, so please confirm the corresponding data sheet.

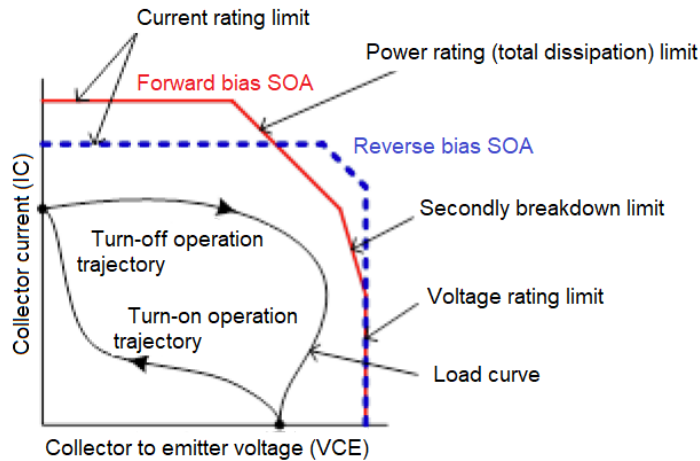

Figure 4. Safe Operating Area (SOA)

3.2.1 Forward bias safe operating area

Figure 5 shows the forward bias safe operation area (FBSOA) of RBN50H65T1FPQ. The SOA is divided into 4 areas based on specific limitations, as listed below.

- ① Area limited by the maximum rating pulse collection current $I_{C(peak)}$.
- ② Area limited by collector dissipation region
- ③ Area limited by the secondly breakdown
Be aware that this causes the safe operation area to be narrower unless the produce has a second breakdown margin.
- ④ Area limited by maximum rating collector-emitter voltage V_{CES} .

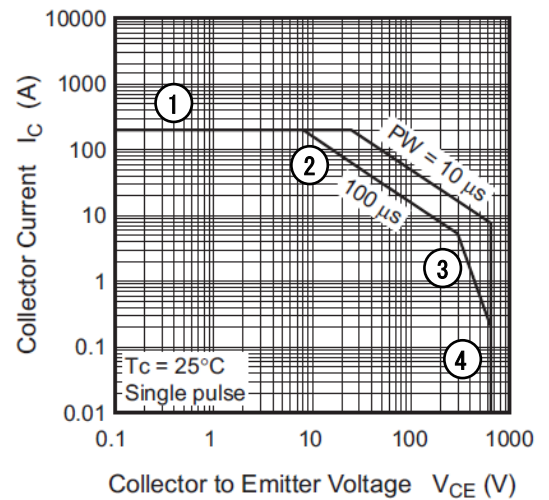

Figure 5. Forward bias safe operating area

3.2.2 Reverse bias safe operating area

Figure 6 shows the reverse bias safe operation area (RBSOA) of RBN50H65T1FPQ.

This characteristic corresponds to the reverse bias SOA of the bipolar transistor. When a reverse bias, including no bias, is applied between the gate and the emitter at turn-off in the inductive load, a high voltage is applied to the IGBT's collector-emitter. At the same time, a large current continues to flow due to the residual hole. However, in this operation the forward bias SOA cannot be applied and the reverse bias SOA is used. The reverse bias SOA is divided into 2 limited areas, as described below; ultimately the area is determined by confirming the actual operation.

- ① Area limited by the maximum rating peak collector current $I_{C(peak)}$.
- ② Area limited by the maximum rating collector-emitter voltage (tolerance) V_{CES} .

Note that the product may breakdown when the designed $V_{CE}-I_C$ operation trajectory deviates from the SOA. Therefore, when designing the circuit, close attention must be paid to dissipation and other performance issues when determining specific characteristics and circuit constants related to breakdown tolerance. For example, reverse bias SOA has a temperature characteristic (deteriorates at high temperature), and the $V_{CE}-I_C$ operating locus changes according to gate resistance R_g and gate voltage V_{GE} .

For this reason, it is necessary to design in R_g and V_{GE} after recognizing the operating environment and minimum gate resistance value at turn-off. Incidentally a snubber circuit can be effective in suppressing dv/dt V_{CE} .

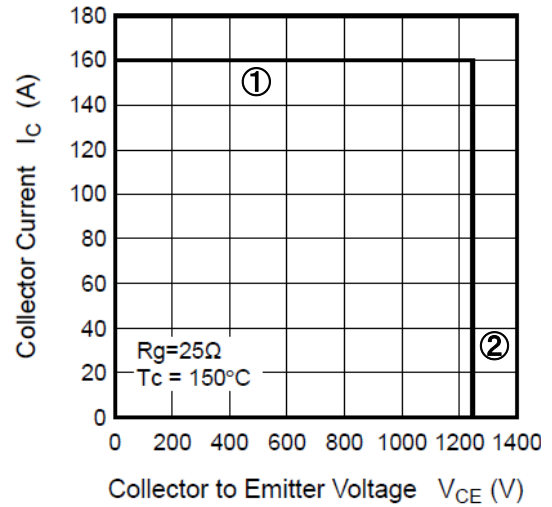

Figure 6. Reverse bias safe operating area

3.3 Static Characteristics

Figure 7 shows the output characteristics of RBN40H125S1FPQ.

The figure depicts the collector-emitter voltage when the collector current flows in an arbitrary gate voltage condition. The collector-emitter voltage, which affects the current capability and loss in the ON state, depends on the gate voltage and case temperature, and must be considered when designing a circuit. The current rises when $V_{CE} = 0.7$ to 0.8 V, but this is due to the forward voltage of the collector-emitter PN junction.

Figure 8 shows the collector-emitter saturation voltage vs. gate voltage characteristics of RBN40H125S1FPQ. Basically, $V_{CE(sat)}$ decreases as gate-emitter voltage V_{GE} increases, but the change is minimal when $V_{GE} = 15$ V or more, so we recommend using $V_{GE} = 15$ V as much as possible.

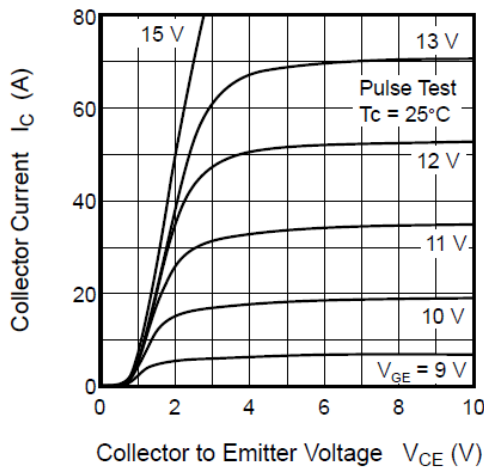

Figure 7. Typical Output Characteristics

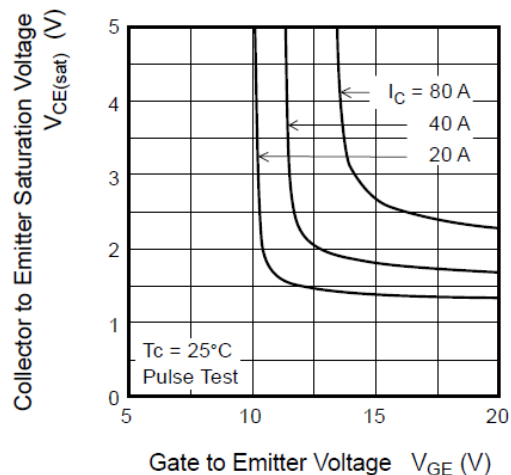

Figure 8. Collector to Emitter Saturation Voltage vs. Gate to Emitter Voltage

Figure 9 shows the collector current vs. gate voltage characteristics of RBN40H12S1FPQ.

The I_C - V_{GE} characteristics are temperature dependent, but the area of low gate voltage around the cross point are negative temperature coefficients and the high gate voltage area indicates positive temperature coefficients. Since power devices generate heat during operation, it is preferable to focus on the positive temperature coefficient area especially in parallel operations. The recommended usage condition of $V_{GE} = 15V$ shows the positive temperature characteristics.

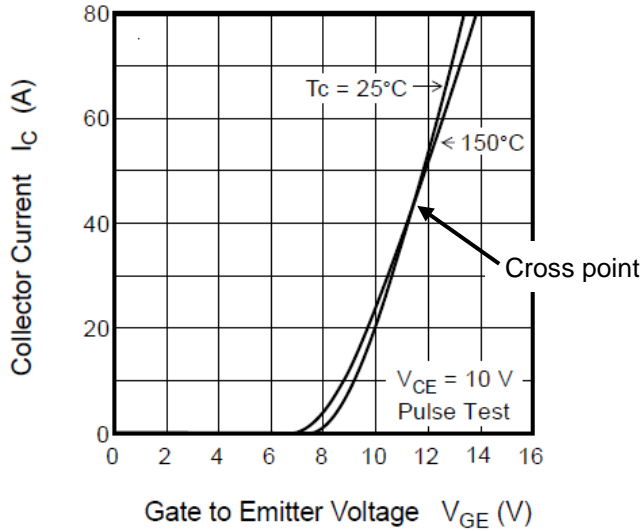

Figure 9. Typical Transfer Characteristics

Figures 10 and 11 show the temperature dependency of the collector-emitter saturation voltage and gate threshold voltage, respectively.

Since the collector-emitter saturation voltage has a positive temperature dependency, it is difficult for current to flow when heat is generated by the IGBT operation, hindering current concentration in parallel operation. Oppositely, the gate-emitter threshold voltage is dependent on negative temperatures. At high temperatures, the threshold voltage decreases, introducing a greater risk of mis-operation due to noise. Therefore, careful verification based on these characteristics is necessary.

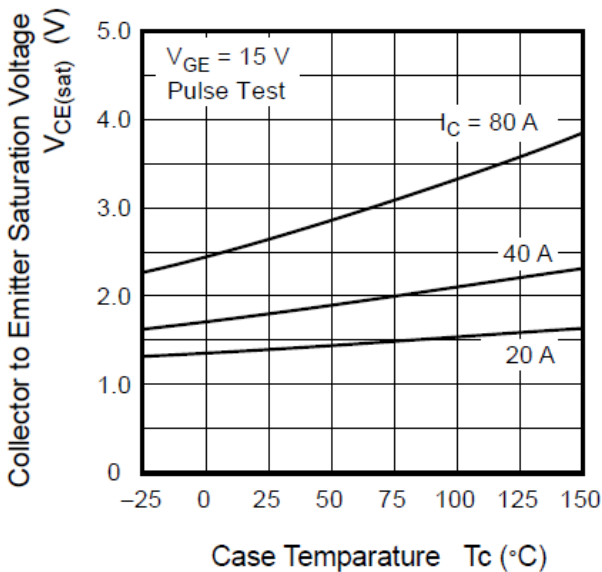

Figure 10. Collector to Emitter Saturation Voltage vs. Case Temperature

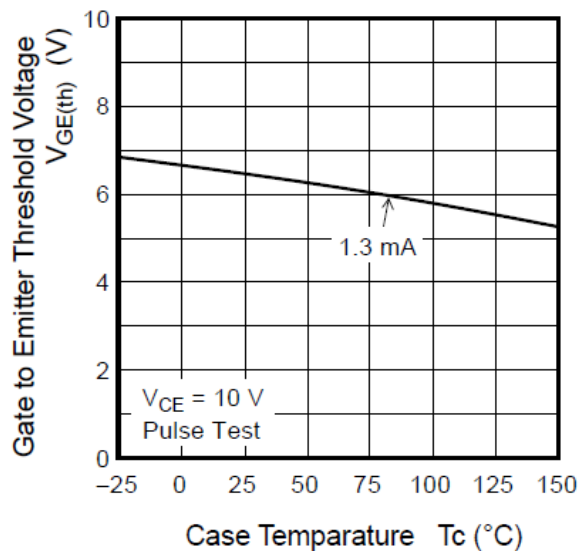

Figure 11. Collector to Emitter Saturation Voltage vs. Case Temperature

3.4 Capacitance Characteristics

3.4.1 Gate Charge Characteristics

Figure 12 shows the gate charge characteristics of RBN40H125S1FPQ. IGBT gate characteristics are basically based on the same concepts used for power MOSFETs and serve as the parameters that determine drive current and drive dissipation. Figure 13 shows the characteristic curve, sectioned into Periods 1 to 3. The operation corresponding to each period is described below.

Period 1

Gate voltage is increased to the threshold voltage at which current begins to flow. The part rising from $V_{GE} = 0V$ is the part charging gate-emitter capacitance C_{ge} .

Period 2

During the transition from the active region to the saturation region, the collector-emitter voltage changes and gate-collector capacitance C_{gc} is charged. This period has an apparent capacitance increases due to the mirror effect, so V_{GE} becomes constant, but when IGBT is completely in the ON state, and the change in V_{CE} and the mirror effect disappear.

Period 3

In this period the IGBT reaches the fully saturated state and the V_{CE} no longer changes.

Voltage V_{GE} rises with time.

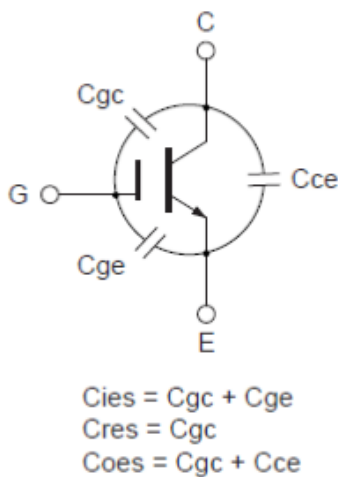

Figure 12. Capacitance Between terminal

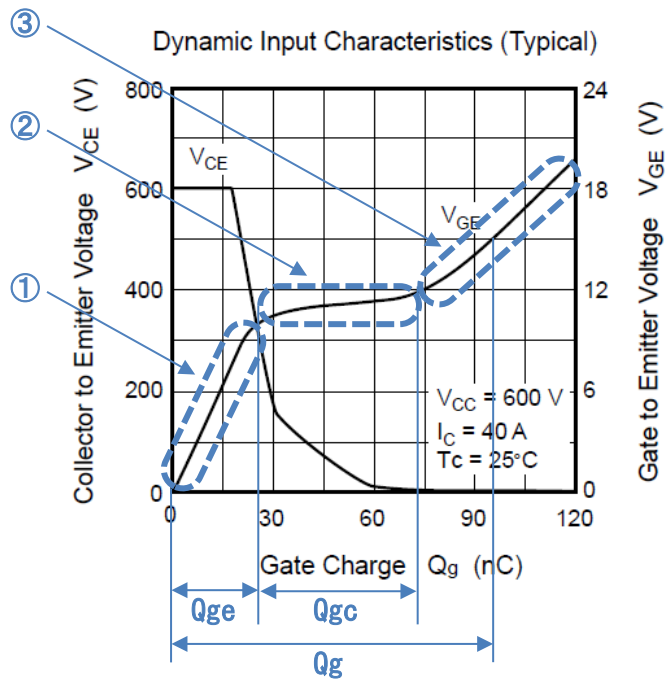

Figure 13. Dynamic Input Characteristics

3.4.2 How to determine gate drive current

This gate drive current is determined by gate series resistance R_g , signal source resistance R_s of the drive circuit, element internal resistance r_g , and drive voltage $V_{GE(ON)}$ and is expressed with the following formula.

$$I_{G(\text{peak})} = \frac{V_{GE(\text{on})}}{R_g + R_s + r_g}$$

Accordingly, the output stage of the drive circuit must be designed with current drive capability equal to or larger than $I_{G(\text{peak})}$. The actual peak current tends to be smaller than the calculated value due to the drive circuit delay and the delay in the di/dt rise of the gate current due to factors such as the wiring inductance from the drive circuit to the gate pad of the IGBT chip.

In addition, the switching characteristics for both turn-on and turn-off are heavily dependent on R_g , ultimately affecting switching time and switching losses. It is important to select the optimal R_g based on the device in use.

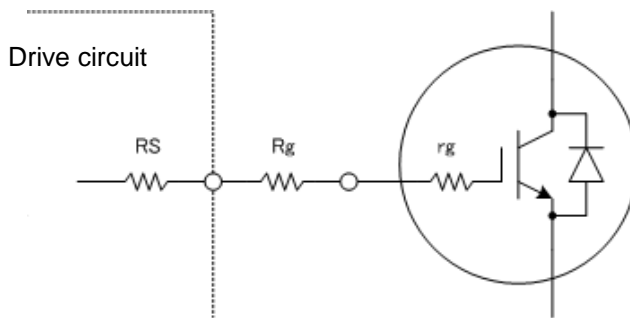

Figure 14. Drive Circuit Resistance Component

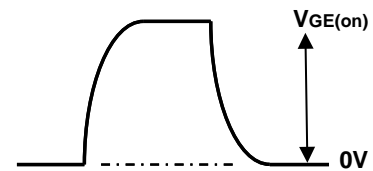

Figure 15. Gate terminal Drive Waveform

3.4.3 Drive loss calculation

Drive loss is expressed by the following equation when all generated losses of the drive circuit are consumed by these resistance components. (f : switching frequency)

$$P_{(\text{Drive Loss})} = V_{GE(\text{on})} \times Q_g \times f$$

3.5 Switching Characteristics

As the IGBT is a switching element, switching speed (turn-on time, turn-off time) is one of the key parameters influencing efficiency (loss). Figure 16 shows the Inductance Load switching measurement circuit.

Since the diode clamp is connected in parallel to inductive load L, the IGBT turn-on time (turn-on loss) is also affected by the diode's recovery characteristics.

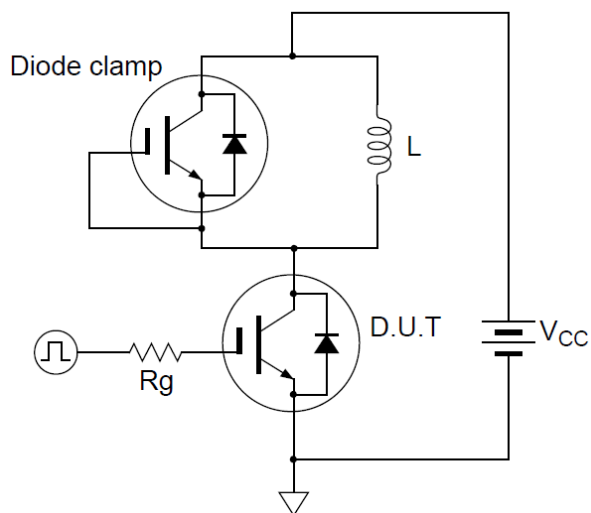

Figure 16. Switching Characteristics Measurement Circuit:
Inductance Load

Switching Time

Switching time, as shown in Figure 17, is divided into 4 measurement periods. Since the time changes significantly for each period according to T_j , I_C , V_{CE} , V_{GE} , and R_g conditions, these times is measured under the specified conditions.

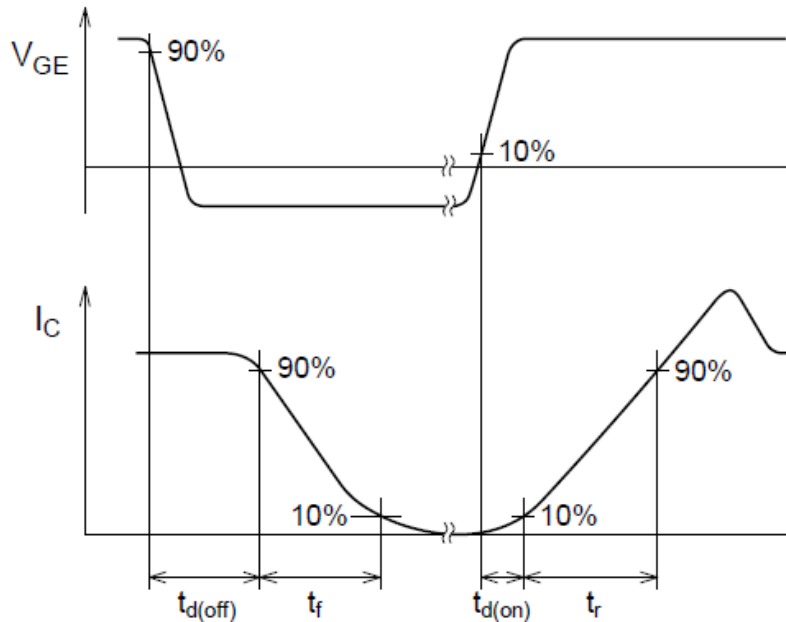

Figure 17. Switching Waveform

$t_{d(on)}$ (turn-on delay time)

The time from when gate-emitter voltage reaches 10% of forward bias voltage to until the collector current rises to 10%.

t_r (rise time)

The time from when collector current rise from 10% to 90%.

$t_{d(off)}$ (turn-off delay time)

The time from when gate-emitter voltage reaches 90% of forward bias voltage to until the collector current falls to 90%.

t_f (fall time)

The time from when collector current falls from 90% to 10%.

The IGBT turn-off period includes a tail time (t_{tail}). This is the time it takes for the excess carriers remaining on the collector side to disappear by recombination even if the IGBT turns off and the collector-emitter voltage rises.

3.6 Built-in Diode Characteristics

Unlike power MOSFETs, the IGBT does not include a parasitic diode. Therefore, a composite IGBT which features a built-in Fast Recovery Diode (FRD) chip is used for inductance charge control in motor and similar applications.

In such devices, performance of both the IGBT and the built-in diode greatly influences equipment efficiency and noise. In addition, reverse recovery and forward voltage characteristics are important diode parameters.

3.6.1 Built-in diode reverse recovery characteristics

Accumulated minority carriers are emitted when switching from the state where forward current flows through the diode to the state of reverse element. The time required for these minority carriers to be completely emitted is called the reverse recovery time (t_{rr}), the current during this time is called reverse recovery current (I_{rr}), and the integral value of these two periods is called the reverse recovery charge (Q_{rr}).

$$Q_{rr} = \frac{1}{2} I_{rr} \times t_{rr}$$

Since the t_{rr} period is equivalently short circuited, it entails a large loss. In addition, it limits the frequency during the switching operation. In general, fast t_{rr} and small I_{rr} (Q_{rr} is small) is considered optimal. These characteristics are highly dependent on forward bias current I_F , di_F/dt , and junction temperature T_j .

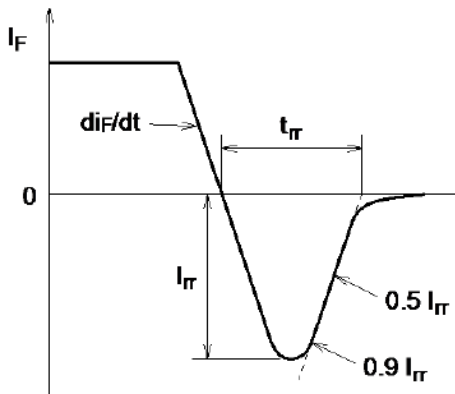

(a) Built-in Diode Reverse Recovery Characteristics

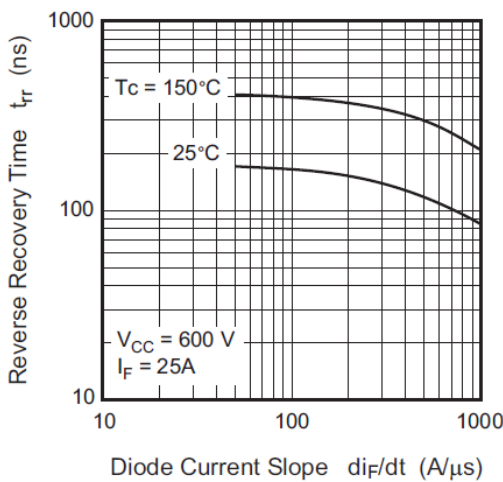

(b) Reverse Recovery Time vs. Diode Current Slope

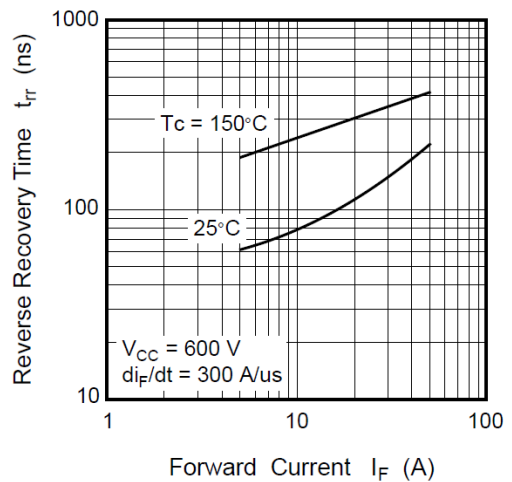

(c) Reverse Recovery Time vs. Forward Current

Figure 18. Diode Switching Characteristics

However, when t_{tr} becomes faster, di/dt becomes steeper at recovery timing, as does the corresponding collector-emitter voltage dv/dt , which increases the tendency for noise generation. Examples of noise countermeasures are provided below.

- 1) Reduce di_F/dt (slow down IGBT turn-on time).
- 2) Add a snubber capacitor between the IGBT collector and emitter to mitigate collector-emitter voltage dv/dt .
- 3) Change the built-in diode to a soft recovery.

The reverse recovery characteristic greatly depends on the withstand voltage and the capacity of the device. This characteristic can be improved with lifetime control, heavy metal diffusion, and other methods.

3.6.2 Built-in diode forward voltage characteristics

Figure 19 shows the built-in diode output characteristics of RBN40H125S1FPQ.

Diode forward voltage V_F indicates falling voltage generated when diode current I_F flows in the diode forward direction. As this characteristic affects power loss during power regeneration (free-wheeling diode) in motor applications, the lower the V_F the better. In addition, as shown in Figure 19, the positive and negative temperature characteristics depend on the magnitude of the diode forward current I_F .

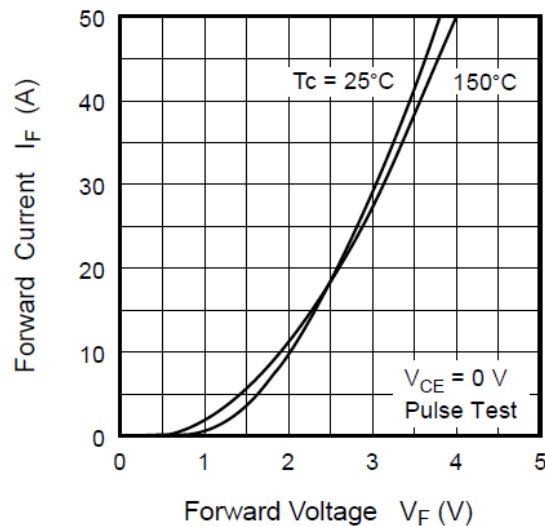

Figure 19. Diode Forward Current vs. Diode Forward Voltage Characteristics

3.7 Thermal Resistance Characteristics

Figure 20 shows the transient thermal resistance characteristics of the IGBT and built-in diode of RBN40H125S1FPQ.

This is a characteristic for calculating junction temperature T_j . The pulse width (PW) on the horizontal axis is the operation time, describing the 1 shot single pulse and the conditions of repeated operation.

For example, $PW = 1\text{ms}$ and $D = 0.2$ (duty cycle = 20%) means that the repetition frequency is 200Hz because the repetition period is $T = 5\text{ms}$.

Assuming $PW=1\text{ms}$ and $D = 0.2$, using dissipation power $P_d=60\text{W}$, the increase in IGBT junction temperature ΔT_j can be calculated as follows:

$$\Delta T_j = P_d \times \theta_{j-c}(t) = 60 \times 0.17 = 10.2^\circ\text{C}$$

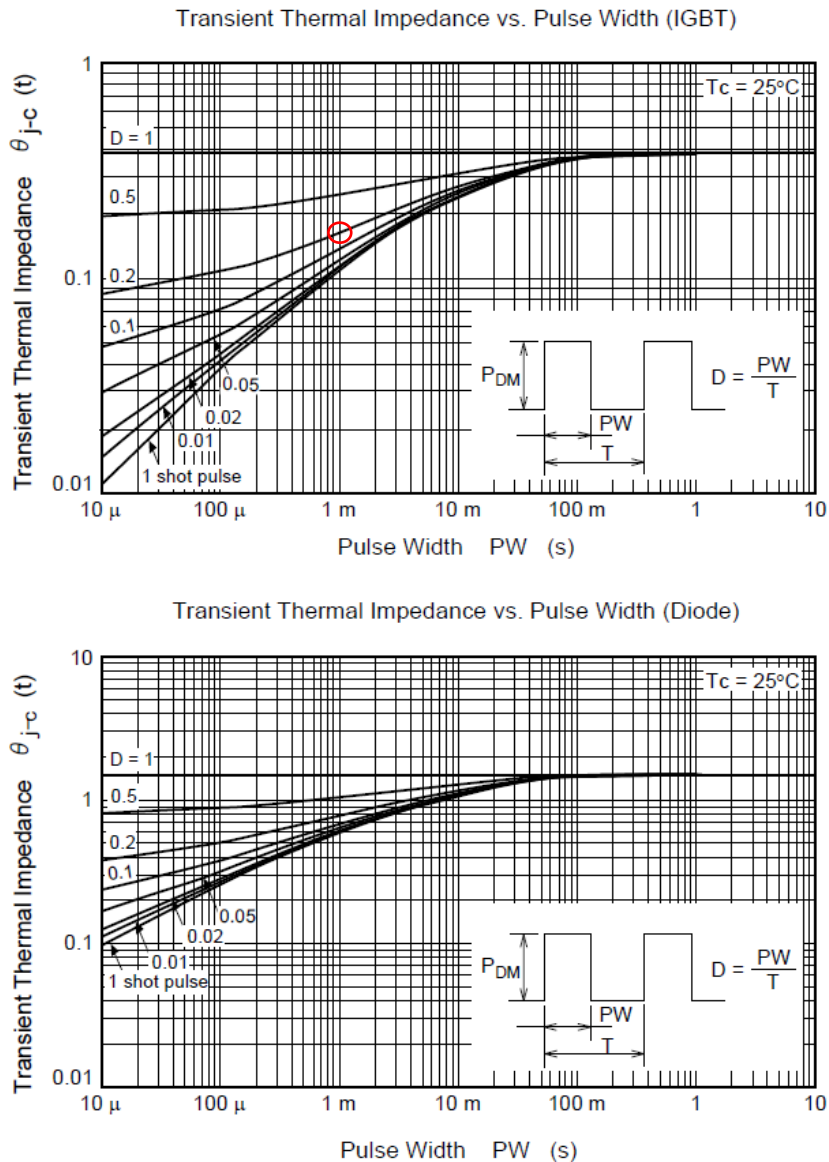

Figure 20. Transient Thermal Impedance vs. Pulse Width

3.8 Load Short Circuit Characteristics

Elements used for bridge circuits such as inverters must include a short circuit (overcurrent) protection circuit that withstands conditions and prevents damage for the period until the gate voltage is cut off, even if the set is short circuited.

Figure 21 and 22 show the short circuit withstanding time and short circuit current capability of RBN40H125S1FPQ.

This short circuit withstanding is generally expressed in terms of time t_{SC} . This withstanding depends greatly on the gate-emitter voltage, case temperature, and power supply voltage. This should be taken into consideration when circuit design. And select optimal device.

Gate-emitter voltage V_{GE} :

As the gate voltage increases, the short circuit current increases and the withstand capability decreases.

Case temperature:

The temperature rise causes ΔT_j and withstand capability to drop until the device breaks down.

Power supply voltage V_{CC} :

The increase in voltage causes the short circuit current to increase and the withstand capability to drop.

In addition, when the short circuit (overcurrent) protection circuit detects the short circuit current and the gate signal is turned off, the short circuit current is extremely large compared with the normal current value. When this large current is turned off at normal gate resistance R_g , it can generate a surge voltage that exceeds the rating. Therefore, it is necessary to set the gate resistance for short circuit protection at several to 10-times over the normal value (yet stay within the forward bias SOA) to prevent surge voltage generation at collector-emitter when the short circuit current is cut off. Further, the short circuit withstand time t_{SC} has distribution in each product. Make sure to set an ample margin of at least twice the normal amount of time required for the short-circuit protection circuit to start running.

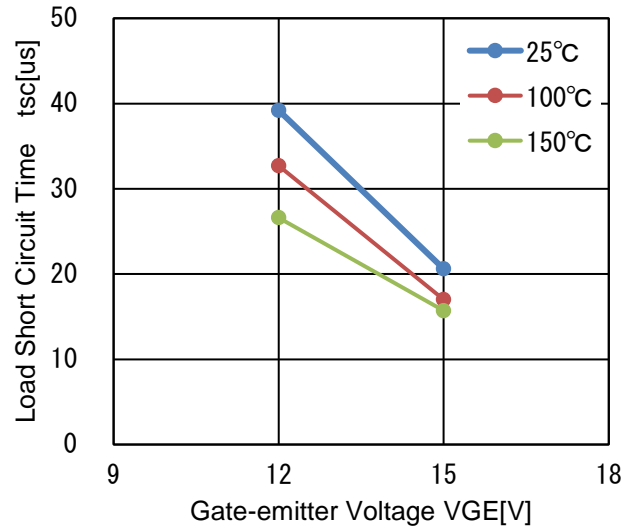

Figure 21 Short Circuit Withstanding Time Capability Data

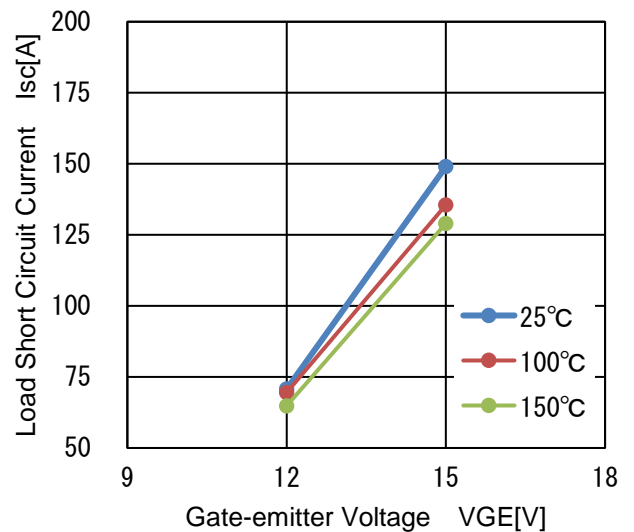

Figure 22 Short Circuit Current Capability Data

4. Maximum Junction Temperature T_{jmax} for 175°C

The absolute maximum rating of the junction temperature T_j is conventionally 150°C for general industrial-use products, but $T_{jmax} = 175°C$ is sometimes required for new generation products to meet high temperature specifications. Renesas has prepared some of our IGBT products to support 175°C usage requirements.

Table 3 shows an example of reliability test conditions for RBN40H125S1FPQ supporting 175°C operations.

To ensure successful operations at $T_{jmax} = 175°C$, some of the conditions for the conventional reliability test at 150°C were changed and operation verification carried out.

However, test conditions vary depending on the product. Please confirm the reliability report corresponding to the product you are using for more details.

Table 3. Example RBN40H125S1FPQ Reliability Test Conditions (excerpt)

Item	Test Conditions
High-temperature reverse bias test (HTRB)	1000 h $V_{CE} = V_{CES}(\text{rating}) \times 80\%$ $T_j = 175°C$

Note: Depending on the product, reliability tests may be carried out under individual conditions.

Also note that the T_{jmax} value is not only a limitation for continuous operations, but also a rating regulation that should not be exceeded even instantaneously. Protection from heat emissions, even instantaneous temperature increases, from an element during switching operations should be taken into account. Always use IGBT devices under conditions that never exceed $T_j = 175°C$.

For maximum ratings, including T_{jmax} , check individual reliability data (reliability test reports, estimated failure rates, etc.) as well as the Renesas Semiconductor Reliability Handbook (Basic Recommendations for Handling and Using Semiconductor Devices) to confirm usage conditions. Upon confirming usage conditions, always design for reliability, taking the appropriate derating methods into account.

5. IGBT Losses

5.1 Operating Loss

When driving an inductive load with an IGBT, the loss is largely divided into conduction loss and switching loss. The loss occurring when the IGBT is fully turned on is referred to as conduction loss, and the loss occurring while switching from ON to OFF or OFF to ON is called switching loss.

Since loss is determined by integration of voltage and current as shown in the following expression, loss occurs due to the influence of collector-emitter saturation voltage $V_{CE(sat)}$ even in conduction. $V_{CE(sat)}$ must be low, as the loss leads to heat generation in the device. Switching loss is explained in detail in the next section.

$$\text{Loss (P)} = \text{voltage (V)} \times \text{current (I)}$$

$$\text{Turn-on loss: } P_{(\text{turn ON})} = V_{CE(sat)} \times I_C$$

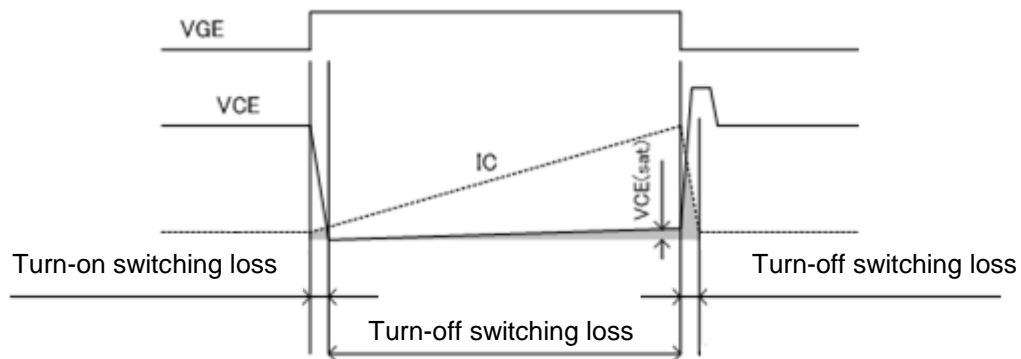

Figure 23. Operating Loss: inductive load drive example

5.2 Switching Loss

As IGBT loss is difficult to calculate using switching time, reference data is included in the data sheet to help system designers calculate switching loss.

Figure 24 shows the switching loss characteristics for RBN40H125S1FPQ.

E_{on} and E_{off} are highly dependent on collector current, gate resistance, and operating temperature.

E_{on} (Turn-on energy loss)

The amount of loss generated at turn-on under the inductive load conditions, including the recovery loss at reverse recovery of the diode.

E_{on} is measured from when the gate voltage is applied and the collector current starts to flow, until the IGBT completely shifts to the ON state.

E_{off} (Turn-off energy loss)

The amount of loss generated at turn-off under the inductive load conditions, including the tail current. E_{off} is measured from when the gate current is cut off and the collector-emitter voltage starts to rise, until the IGBT completely shifts to the OFF state.

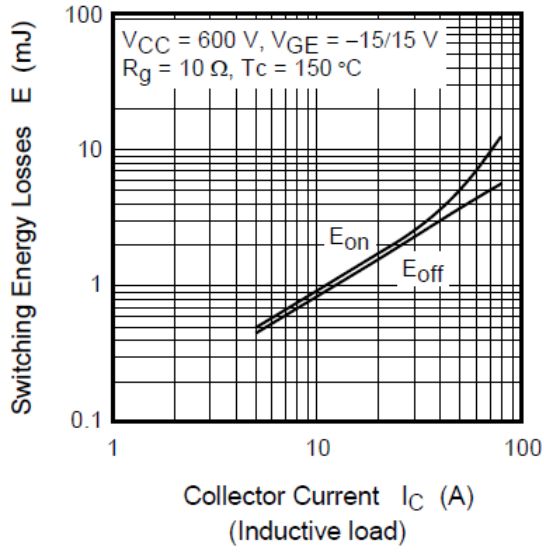

(a) Switching Loss vs. Collector Current Dependency

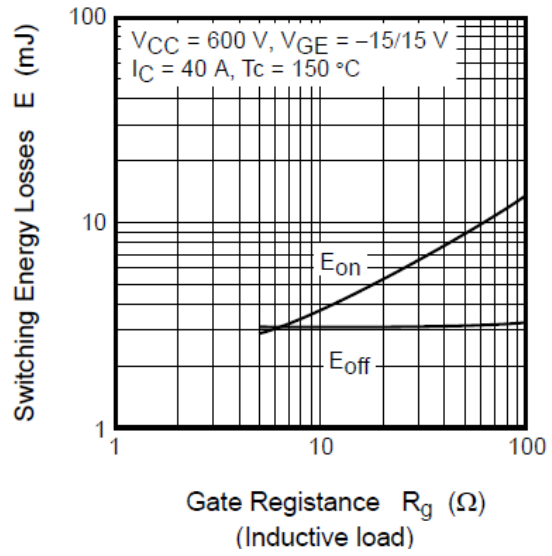

(b) Switching Loss vs. Gate Resistance Dependency

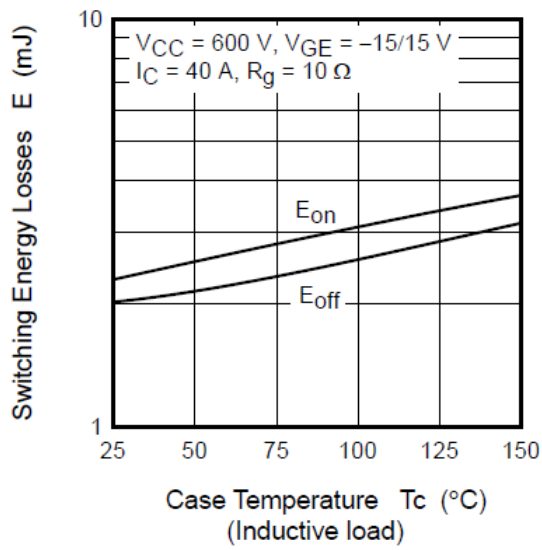

(c) Switching Loss vs. Case Temperature Dependency

Figure 24. Switching Characteristics

Website and Support

Renesas Electronics Website

<http://www.renesas.com/>

Inquiries

<http://www.renesas.com/contact/>

All trademarks and registered trademarks are the property of their respective owners.

Notice

1. Descriptions of circuits, software and other related information in this document are provided only to illustrate the operation of semiconductor products and application examples. You are fully responsible for the incorporation or any other use of the circuits, software, and information in the design of your product or system. Renesas Electronics disclaims any and all liability for any losses and damages incurred by you or third parties arising from the use of these circuits, software, or information.
2. Renesas Electronics hereby expressly disclaims any warranties against and liability for infringement or any other claims involving patents, copyrights, or other intellectual property rights of third parties, by or arising from the use of Renesas Electronics products or technical information described in this document, including but not limited to, the product data, drawings, charts, programs, algorithms, and application examples.
3. No license, express, implied or otherwise, is granted hereby under any patents, copyrights or other intellectual property rights of Renesas Electronics or others.
4. You shall not alter, modify, copy, or reverse engineer any Renesas Electronics product, whether in whole or in part. Renesas Electronics disclaims any and all liability for any losses or damages incurred by you or third parties arising from such alteration, modification, copying or reverse engineering.
5. Renesas Electronics products are classified according to the following two quality grades: "Standard" and "High Quality". The intended applications for each Renesas Electronics product depends on the product's quality grade, as indicated below.

Standard: Computers; office equipment; communications equipment; test and measurement equipment; audio and visual equipment; home electronic appliances; machine tools; personal electronic equipment; industrial robots; etc.

High Quality: Transportation equipment (automobiles, trains, ships, etc.); traffic control (traffic lights); large-scale communication equipment; key financial terminal systems; safety control equipment; etc.

Unless expressly designated as a high reliability product or a product for harsh environments in a Renesas Electronics data sheet or other Renesas Electronics document, Renesas Electronics products are not intended or authorized for use in products or systems that may pose a direct threat to human life or bodily injury (artificial life support devices or systems; surgical implantations; etc.), or may cause serious property damage (space system; undersea repeaters; nuclear power control systems; aircraft control systems; key plant systems; military equipment; etc.). Renesas Electronics disclaims any and all liability for any damages or losses incurred by you or any third parties arising from the use of any Renesas Electronics product that is inconsistent with any Renesas Electronics data sheet, user's manual or other Renesas Electronics document.

6. When using Renesas Electronics products, refer to the latest product information (data sheets, user's manuals, application notes, "General Notes for Handling and Using Semiconductor Devices" in the reliability handbook, etc.), and ensure that usage conditions are within the ranges specified by Renesas Electronics with respect to maximum ratings, operating power supply voltage range, heat dissipation characteristics, installation, etc. Renesas Electronics disclaims any and all liability for any malfunctions, failure or accident arising out of the use of Renesas Electronics products outside of such specified ranges.
7. Although Renesas Electronics endeavors to improve the quality and reliability of Renesas Electronics products, semiconductor products have specific characteristics, such as the occurrence of failure at a certain rate and malfunctions under certain use conditions. Unless designated as a high reliability product or a product for harsh environments in a Renesas Electronics data sheet or other Renesas Electronics document, Renesas Electronics products are not subject to radiation resistance design. You are responsible for implementing safety measures to guard against the possibility of bodily injury, injury or damage caused by fire, and/or danger to the public in the event of a failure or malfunction of Renesas Electronics products, such as safety design for hardware and software, including but not limited to redundancy, fire control and malfunction prevention, appropriate treatment for aging degradation or any other appropriate measures. Because the evaluation of microcomputer software alone is very difficult and impractical, you are responsible for evaluating the safety of the final products or systems manufactured by you.
8. Please contact a Renesas Electronics sales office for details as to environmental matters such as the environmental compatibility of each Renesas Electronics product. You are responsible for carefully and sufficiently investigating applicable laws and regulations that regulate the inclusion or use of controlled substances, including without limitation, the EU RoHS Directive, and using Renesas Electronics products in compliance with all these applicable laws and regulations. Renesas Electronics disclaims any and all liability for damages or losses occurring as a result of your noncompliance with applicable laws and regulations.
9. Renesas Electronics products and technologies shall not be used for or incorporated into any products or systems whose manufacture, use, or sale is prohibited under any applicable domestic or foreign laws or regulations. You shall comply with any applicable export control laws and regulations promulgated and administered by the governments of any countries asserting jurisdiction over the parties or transactions.
10. It is the responsibility of the buyer or distributor of Renesas Electronics products, or any other party who distributes, disposes of, or otherwise sells or transfers the product to a third party, to notify such third party in advance of the contents and conditions set forth in this document.
11. This document shall not be reprinted, reproduced or duplicated in any form, in whole or in part, without prior written consent of Renesas Electronics.
12. Please contact a Renesas Electronics sales office if you have any questions regarding the information contained in this document or Renesas Electronics products.

(Note 1) "Renesas Electronics" as used in this document means Renesas Electronics Corporation and also includes its directly or indirectly controlled subsidiaries.

(Note 2) "Renesas Electronics product(s)" means any product developed or manufactured by or for Renesas Electronics.

(Rev.4.0-1 November 2017)



SALES OFFICES

Renesas Electronics Corporation

<http://www.renesas.com>

Refer to "<http://www.renesas.com/>" for the latest and detailed information.

Renesas Electronics America Inc.

1001 Murphy Ranch Road, Milpitas, CA 95035, U.S.A.
Tel: +1-408-432-8888, Fax: +1-408-434-5351

Renesas Electronics Canada Limited

9251 Yonge Street, Suite 8309 Richmond Hill, Ontario Canada L4C 9T3
Tel: +1-905-237-2004

Renesas Electronics Europe Limited

Dukes Meadow, Millboard Road, Bourne End, Buckinghamshire, SL8 5FH, U.K
Tel: +44-1628-651-700, Fax: +44-1628-651-804

Renesas Electronics Europe GmbH

Arcadiastrasse 10, 40472 Düsseldorf, Germany
Tel: +49-211-6503-0, Fax: +49-211-6503-1327

Renesas Electronics (China) Co., Ltd.

Room 1709 Quantum Plaza, No.27 ZhichunLu, Haidian District, Beijing, 100191 P. R. China
Tel: +86-10-8235-1155, Fax: +86-10-8235-7679

Renesas Electronics (Shanghai) Co., Ltd.

Unit 301, Tower A, Central Towers, 555 Langao Road, Putuo District, Shanghai, 200333 P. R. China
Tel: +86-21-2226-0888, Fax: +86-21-2226-0999

Renesas Electronics Hong Kong Limited

Unit 1601-1611, 16/F., Tower 2, Grand Century Place, 193 Prince Edward Road West, Mongkok, Kowloon, Hong Kong
Tel: +852-2265-6688, Fax: +852 2886-9022

Renesas Electronics Taiwan Co., Ltd.

13F, No. 363, Fu Shing North Road, Taipei 10543, Taiwan
Tel: +886-2-8175-9600, Fax: +886 2-8175-9670

Renesas Electronics Singapore Pte. Ltd.

80 Bendemeer Road, Unit #06-02 Hyflux Innovation Centre, Singapore 339949
Tel: +65-6213-0200, Fax: +65-6213-0300

Renesas Electronics Malaysia Sdn.Bhd.

Unit 1207, Block B, Menara Amcorp, Amcorp Trade Centre, No. 18, Jln Persiaran Barat, 46050 Petaling Jaya, Selangor Darul Ehsan, Malaysia
Tel: +60-3-7955-9390, Fax: +60-3-7955-9510

Renesas Electronics India Pvt. Ltd.

No.777C, 100 Feet Road, HAL 2nd Stage, Indiranagar, Bangalore 560 038, India
Tel: +91-80-67208700, Fax: +91-80-67208777

Renesas Electronics Korea Co., Ltd.

17F, KAMCO Yangjae Tower, 262, Gangnam-daero, Gangnam-gu, Seoul, 06265 Korea
Tel: +82-2-558-3737, Fax: +82-2-558-5338