

# Application Note

## ADC Current Sense

### AN-CM-291

#### Abstract

*This application note describes how to implement an analog-to-digital converter (ADC) in the SLG46855V to measure current drawn by a load. The correlating ADC code can be read from the counter data via I2C. It also details some accuracy analysis of the read ADC value.*

*This application note comes complete with design files which can be found in the References section.*

---

---

## ADC Current Sense

### Contents

Abstract .....	1
Contents .....	2
Figures.....	2
Tables .....	2
1 Terms and Definitions.....	3
2 References .....	3
3 Introduction.....	4
4 ADC Architecture .....	4
5 Internal Circuit .....	4
6 External Circuit.....	5
7 I2C Read Instructions .....	5
8 Results.....	6
9 Conclusions .....	10
Appendix A.....	11
Revision History .....	12

### Figures

Figure 1: External Circuit Schematic .....	5
Figure 2: Difference Between Measured and Theoretical ADC Values, VDD = 4.3 V .....	7
Figure 3: Difference Between Measured and Theoretical ADC Values, VDD = 3.9 V .....	8
Figure 4: Difference Between Measured and Theoretical ADC Values, VDD = 3.6 V .....	9
Figure 5: Summary Graph of Differences between Measured and Theoretical ADC Values .....	10
Figure 6: Graph of Correlation between Theoretical ADC values and Load Current.....	10
Figure 7: View in GreenPAK Designer .....	11

### Tables

Table 1: Example Code to Current Comparison .....	4
Table 2: I2C Structure .....	5
Table 3: Component Values for Test Circuit .....	6
Table 4: Measured Values with VDD = 4.3 V .....	7
Table 5: Measured Values with VDD = 3.9 V .....	8
Table 6: Measured Values with VDD = 3.6 V .....	9

---

## ADC Current Sense

### 1 Terms and Definitions

ADC	Analog to digital converter
DAC	Digital to analog converter
PWM	Pulse width modulation

### 2 References

For related documents and software, please visit:

[GreenPAK™ Programmable Mixed-Signal Products | Renesas](#)

Download our free [GreenPAK™ Designer](#) software [1] to open the .gp files [2] and view the proposed circuit design. Use the [GreenPAK development tools](#) [3] to freeze the design into your own customized IC in a matter of minutes. Find out more in complete library of application notes [4] featuring design examples as well as explanations of features and blocks within the GreenPAK IC.

- [1] [Go Configure™ Software Hub | Renesas](#), Software Download and User Guide
- [2] [AN-CM-291 ADC Current Sense.gp](#), [GreenPAK Design File](#)
- [3] [GreenPAK Development Tools](#), [GreenPAK Development Tools Webpage](#)
- [4] [GreenPAK Application Notes](#), [GreenPAK Application Notes Webpage](#)
- [5] [SLG46855V](#), Datasheet
- [6] [AN-1177](#), Flexible Range ADC with I2C Interface, Application Note

Author: Gino Castillo

## ADC Current Sense

### 3 Introduction

In this application note we will describe how to implement an 8-bit analog-to-digital converter (ADC) in the SLG46855V [5] that can sense load current and interface with an MCU via I2C. This design can be used for various current sensing applications such as ammeters, fault detection systems, and fuel gauges.

### 4 ADC Architecture

The ADC is essentially comprised of an analog comparator and a Digital-to-Analog Converter (DAC). The comparator senses the input voltage vs. the DAC output voltage, and subsequently controls whether to increment or decrement the DAC input code, such that the DAC output converges to the input voltage. The resulting DAC input code becomes the ADC digital output code.

In our implementation, we create a DAC using a pulse-width modulation (PWM) controlled resistor network. We can easily create a precise digitally controlled PWM output using [GreenPAK](#). The PWM when filtered becomes our analog voltage and thus serves as an effective DAC. A distinct advantage of this approach is that it is easy to set the voltages which corresponds to zero code and full scale (equivalently offset and gain) by simply adjusting resistor values. For example, a user wants to ideally read zero code from a temperature sensor with no current (0  $\mu\text{A}$ ) corresponding to 4.3 V, and full-scale code at 1000  $\mu\text{A}$  corresponding to 3.9 V ([Table 1](#)). This is easily implemented by simply setting a few resistor values. By having the ADC range match the sensor range of interest, we make greatest use of the ADC resolution.

**Table 1: Example Code to Current Comparison**

Code (Dec)	Current ( $\mu\text{A}$ )	$V_{\text{SENSE}}$ (V)
0	0	4.3
125	500	4.1
255	1000	3.9

A design consideration for this architecture is that an internal PWM frequency needs to be much faster than the ADC update rate to prevent underdamped behavior of its control loop. At the very least it should be longer than the ADC data counter clock divided by 256. In this design, the ADC update period is set to 1.3312 ms.

### 5 Internal Circuit

The flexible ADC is based on the design presented in AN-1177 [6]. The clock speed is increased from 1 MHz to 12.5 MHz in order to clock the ADC counter since the SLG46855 has a 25 MHz clock available. This allows a much faster update rate for finer sample resolution. The LUT clocking the ADC data clock is changed so it will pass through the 12.5 MHz signal when the PWM DFF is low.

## ADC Current Sense

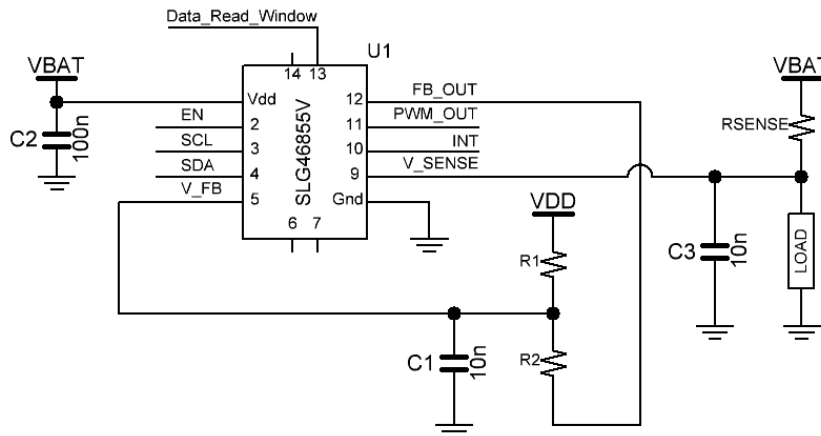

Figure 1: External Circuit Schematic

## 6 External Circuit

An external resistor and capacitor network are used to convert a PWM into an analog voltage as shown in the circuit schematic in Figure 1. The values are calculated for maximum resolution for the maximum current the device will sense. To achieve this flexibility, we add resistors R1 and R2 in parallel to VDD and ground. A resistor divider divides down VBAT to the low side of voltage range. The divider ratio for an expected minimum VBAT can be solved using the following equation:

Equation 1:

$$Divider = 1 - \frac{I_{MAX} \times R_{SENSE}}{V_{BAT MIN}}$$

## 7 I2C Read Instructions

Table 1 describes the I2C command structure to read back the data stored in CNT0. The I2C commands require a start bit, control byte, word address, read bit, and stop bit.

Table 2: I2C Structure

Information	Data (Hex)
Start Bit	[
Control Byte/Slave Address	0x10 (Write); 0x11 (Read)
Word Address/CNT0 Counted Value	0xA5
Read Bit	R
Stop Bit	]

An example I2C command to read back the CNT0 counted value is written below:

[0x10 0xA5] [0x11 R]

The counted value that is read back will be the ADC code value. As an example, an Arduino code is included in the ZIP file of this application note on the website.

## ADC Current Sense

### 8 Results

To test the accuracy of the ADC current sense design, the measured values at a given load current and VDD level were compared to a theoretical value. The theoretical ADC values were calculated with the following equation:

Equation 2:

$$ADC\ Value = \left(1 - \frac{I_{LOAD} \times R_{SENSE} - V_{BAT} + V_{BAT} \times Divider}{V_{BAT} \times (Divider - 1)}\right) \times 256$$

The  $I_{LOAD}$  that correlates with an ADC value is found with the following equation:

Equation 3:

$$I_{LOAD} = \frac{V_{BAT} (Div - 1) \left(1 - \frac{ADC\ Value}{256}\right) + V_{BAT} - V_{BAT} \times Div}{R_{SENSE}}$$

For the following results I used these component values:

**Table 3: Component Values for Test Circuit**

Component	Nominal Value	Measured Value
R <sub>SENSE</sub>	400Ω	381Ω
R <sub>1</sub>	10kΩ	11.87kΩ
R <sub>2</sub>	100kΩ	89.94kΩ
R <sub>LOAD</sub>	50kΩ (potentiometer)	N/A
C <sub>1</sub>	10nF	9.26nF
C <sub>2</sub>	10nF	9.47nF

The resolution of the ADC value to  $I_{LOAD}$  conversion can be calculated by using equation 3 with the measured values in Table 2 and the ADC value set to 1. With a  $V_{BAT}$  of 3.9 V the resolution is 4.96 μA/div.

In order to optimize the ADC current sense circuit to a minimum VDD level of 3.6 V with a maximum current of 1100 μA and a 381 Ω sense resistor, the ideal divider coefficient would be 0.884, based on equation 1. With the values given in Table 2, the actual divider has a divider coefficient of 0.876. Since this is slightly less, it will allow for a slightly larger load current range so the ADC values are close to the full range but will not overflow. The actual divider value is calculated with the following equation:

Equation 4:

$$Divider = \frac{R2}{R1 + R2}$$

Below are the measurements taken of the circuit at three voltage levels: 4.3 V, 3.9 V, and 3.6 V. Each level displays a graph displaying the difference between the measured and theoretical ADC values. Theoretical values are rounded to the closest whole integer. There is a summary graph to compare the differences at the three voltage levels. Afterwards there is a graph displaying the correlation between the theoretical ADC values and load current at the different voltage levels.

## ADC Current Sense

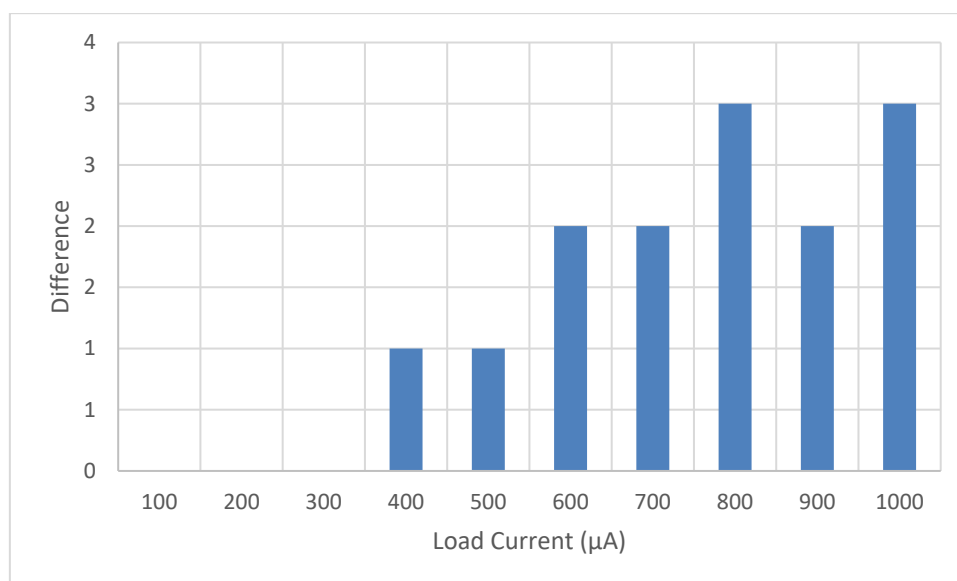

Figure 2: Difference Between Measured and Theoretical ADC Values, VDD = 4.3 V

Table 4: Measured Values with VDD = 4.3 V

Load Current (µA)	ADC Code Measured	ADC Code Theoretical	Difference	Expected V <sub>SENSE</sub>
100	18	18	0	4.2619
200	37	37	0	4.2238
300	55	55	0	4.1857
400	74	73	1	4.1476
500	93	92	1	4.1095
600	112	110	2	4.0714
700	130	128	2	4.0333
800	149	146	3	3.9952
900	167	165	2	3.9571
1000	186	183	3	3.919

## ADC Current Sense

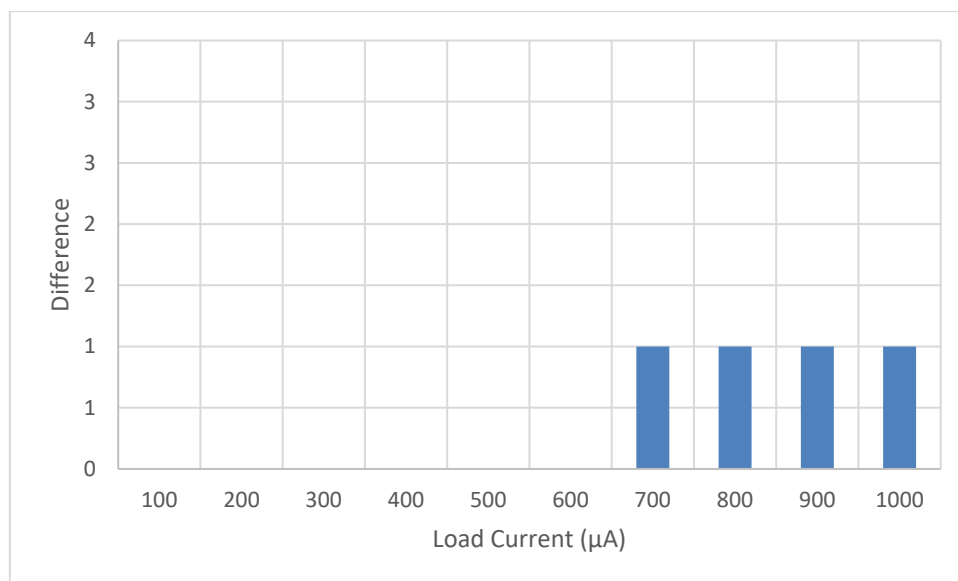

Figure 3: Difference Between Measured and Theoretical ADC Values, VDD = 3.9 V

Table 5: Measured Values with VDD = 3.9 V

Load Current (µA)	ADC Code Measured	ADC Code Theoretical	Difference	Expected ACMP VIN
100	20	20	0	3.8619
200	40	40	0	3.8238
300	61	61	0	3.7857
400	81	81	0	3.7476
500	101	101	0	3.7095
600	121	121	0	3.6714
700	142	141	1	3.6333
800	162	161	1	3.5952
900	183	182	1	3.5571
1000	203	202	1	3.519



## ADC Current Sense

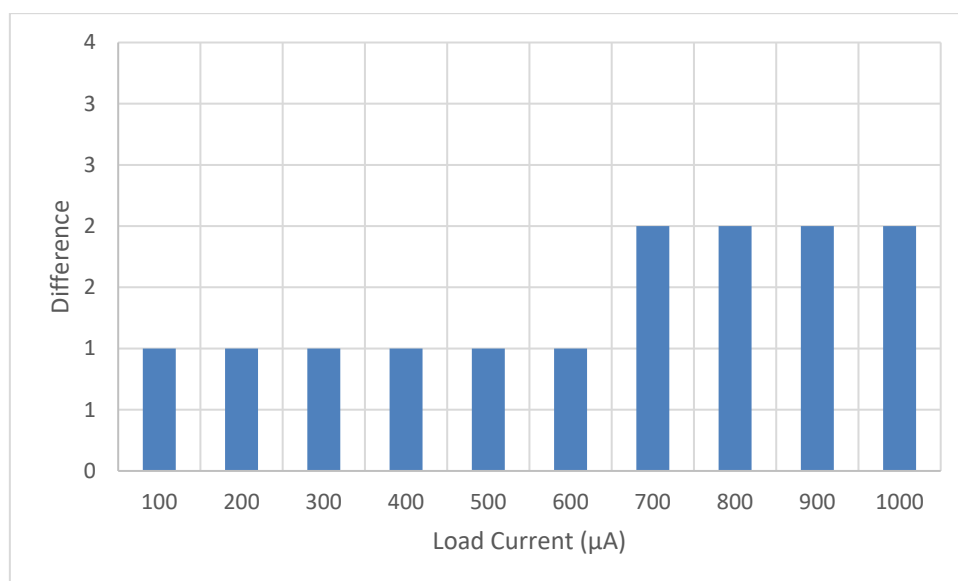

Figure 4: Difference Between Measured and Theoretical ADC Values, VDD = 3.6 V

Table 6: Measured Values with VDD = 3.6 V

Load Current (µA)	ADC Code Measured	ADC Code Theoretical	Difference	Expected ACMP VIN
100	23	22	1	3.5619
200	45	44	1	3.5238
300	67	66	1	3.4857
400	88	87	1	3.4476
500	110	109	1	3.4095
600	132	131	1	3.3714
700	155	153	2	3.3333
800	177	175	2	3.2952
900	199	197	2	3.2571
1000	221	219	2	3.219

ADC Current Sense

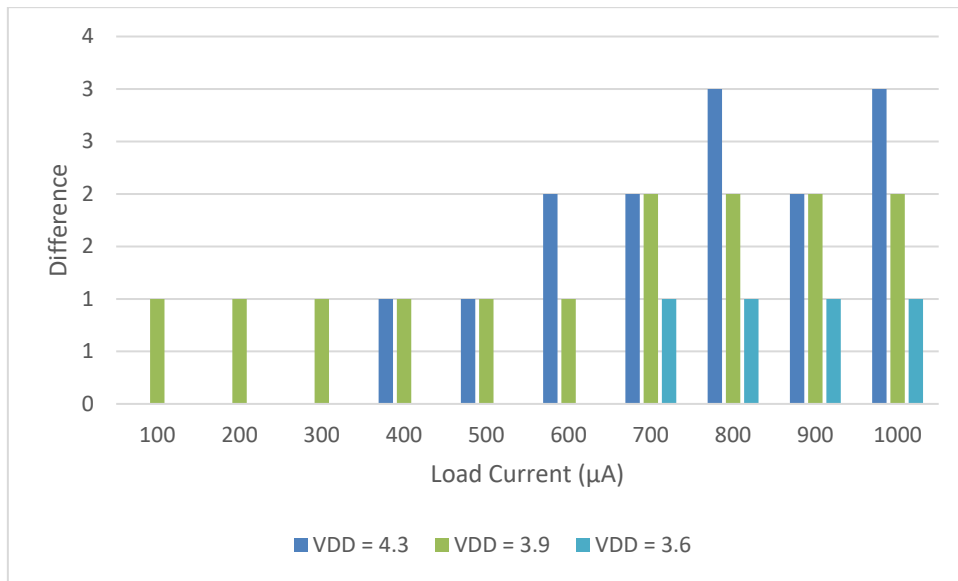

Figure 5: Summary Graph of Differences between Measured and Theoretical ADC Values

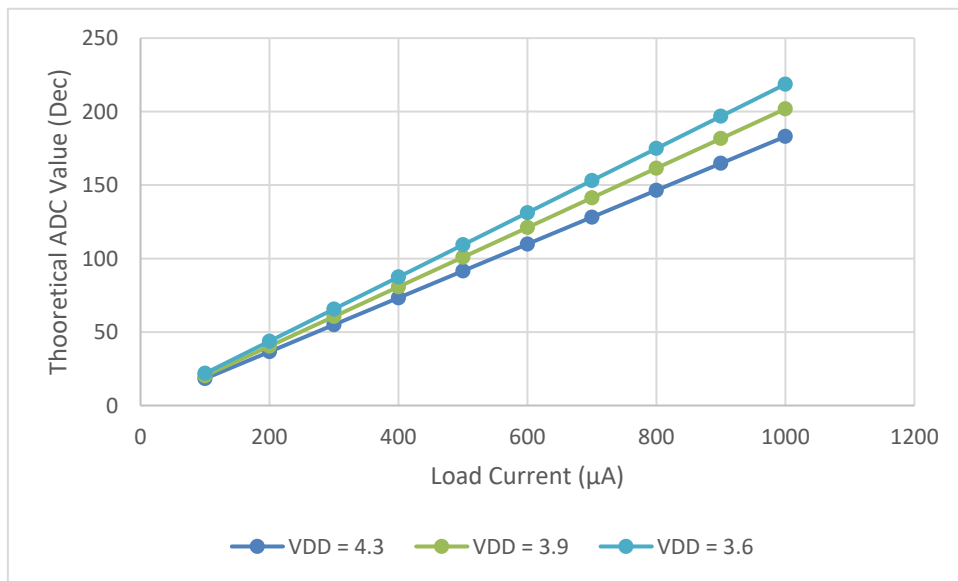

Figure 6: Graph of Correlation between Theoretical ADC values and Load Current

### 9 Conclusions

The device was tested at three voltage levels: 3.6 V, 3.9 V, and 4.3 V. The range of these voltages models a full lithium ion battery that discharges to its nominal level. Of the three voltage levels, it is observed that the device typically was more accurate at 3.9 V for the chosen external circuit. The difference between the measured and theoretical ADC values was only 1 decimal value off at load currents of 700 - 1000 µA. At the given voltage range, the measured ADC values were 3 decimal points above nominal conditions at the worst case. Further adjustments to the resistor divider can be made to optimize different VDD voltage levels.

ADC Current Sense

Appendix A

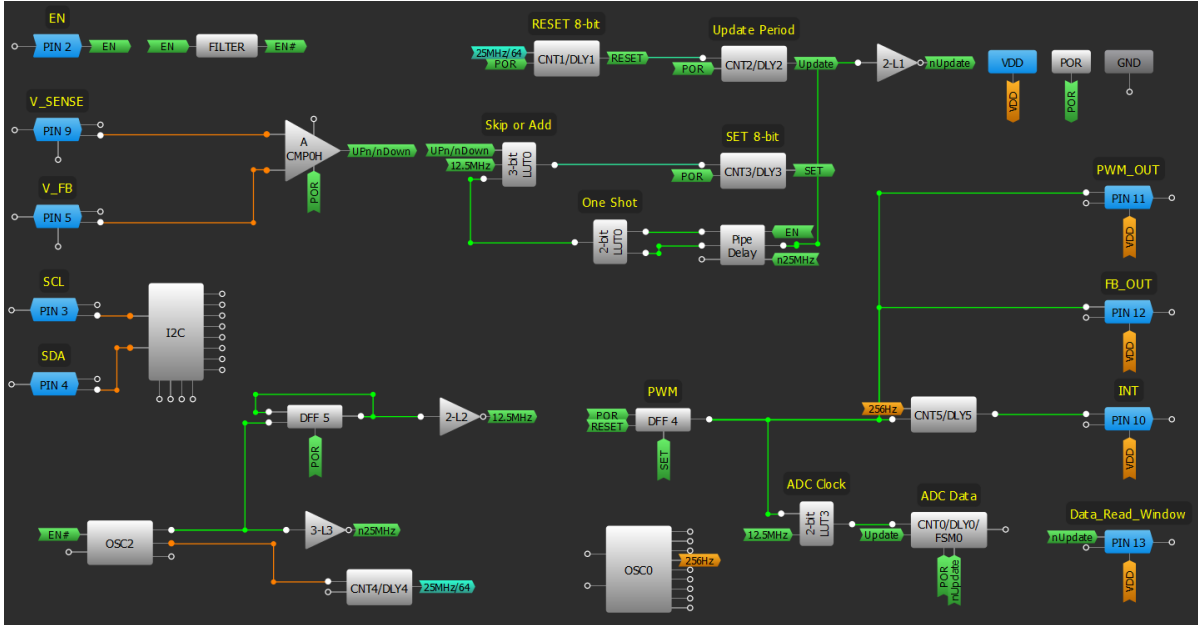

Figure 7: View in GreenPAK Designer

---

**ADC Current Sense****Revision History**

<b>Revision</b>	<b>Date</b>	<b>Description</b>
1.0	23-Oct-2019	Initial version

## IMPORTANT NOTICE AND DISCLAIMER

RENESAS ELECTRONICS CORPORATION AND ITS SUBSIDIARIES (“RENESAS”) PROVIDES TECHNICAL SPECIFICATIONS AND RELIABILITY DATA (INCLUDING DATASHEETS), DESIGN RESOURCES (INCLUDING REFERENCE DESIGNS), APPLICATION OR OTHER DESIGN ADVICE, WEB TOOLS, SAFETY INFORMATION, AND OTHER RESOURCES “AS IS” AND WITH ALL FAULTS, AND DISCLAIMS ALL WARRANTIES, EXPRESS OR IMPLIED, INCLUDING, WITHOUT LIMITATION, ANY IMPLIED WARRANTIES OF MERCHANTABILITY, FITNESS FOR A PARTICULAR PURPOSE, OR NON-INFRINGEMENT OF THIRD-PARTY INTELLECTUAL PROPERTY RIGHTS.

These resources are intended for developers who are designing with Renesas products. You are solely responsible for (1) selecting the appropriate products for your application, (2) designing, validating, and testing your application, and (3) ensuring your application meets applicable standards, and any other safety, security, or other requirements. These resources are subject to change without notice. Renesas grants you permission to use these resources only to develop an application that uses Renesas products. Other reproduction or use of these resources is strictly prohibited. No license is granted to any other Renesas intellectual property or to any third-party intellectual property. Renesas disclaims responsibility for, and you will fully indemnify Renesas and its representatives against, any claims, damages, costs, losses, or liabilities arising from your use of these resources. Renesas' products are provided only subject to Renesas' Terms and Conditions of Sale or other applicable terms agreed to in writing. No use of any Renesas resources expands or otherwise alters any applicable warranties or warranty disclaimers for these products.

(Disclaimer Rev.1.01 Jan 2024)

### Corporate Headquarters

TOYOSU FORESIA, 3-2-24 Toyosu,  
Koto-ku, Tokyo 135-0061, Japan  
[www.renesas.com](http://www.renesas.com)

### Trademarks

Renesas and the Renesas logo are trademarks of Renesas Electronics Corporation. All trademarks and registered trademarks are the property of their respective owners.

### Contact Information

For further information on a product, technology, the most up-to-date version of a document, or your nearest sales office, please visit [www.renesas.com/contact-us/](http://www.renesas.com/contact-us/).