

RL78/G14

7-Segment LED Lighting Control (Arduino API)

Introduction

This application note describes a method to control dynamically lighting of 7-segment LEDs using a program written in an Arduino language using the RL78/G14 Fast Prototyping Board (FPB).

Target Device

RL78/G14

When applying the sample program covered in this application note to another microcomputer, modify the program according to the specifications for the target microcomputer and conduct an extensive evaluation of the modified program.

Contents

1. Specifications	3
1.1 Program Execution Environment.....	4
1.2 Program (Sketch) Configuration.....	5
1.3 Preparations for Project Startup.....	5
1.4 Definitions in the Program (sketch)	6
1.5 Initial Setting Processing	8
1.6 Main Processing Part	8
2. Operating Conditions.....	9
3. Related Application Notes	9
4. Hardware	10
4.1 Example of Hardware Configuration	10
4.2 List of Pins Used	10
5. Software	11
5.1 Summary of Operation	11
(1) Pins to be used are set in the setup function.....	11
(2) The main processing is performed in the loop function.....	11
(3) In the poll_sw function, the state of the SW_USR switch is confirmed every 10 milliseconds, and the number of times the switch is pressed is counted.....	12
5.2 List of Constants.....	13
5.3 List of Variables.....	14
5.4 List of Functions	15
5.5 Specification of Functions	16
5.6 Flowcharts	18
5.6.1 Initial setting function.....	18
5.6.2 Main Processing Function.....	20
5.6.3 Function to set display data for 7-segment LEDs	24
6. Sample Code.....	26
7. Reference Documents.....	26
Revision History	27

1. Specifications

In this application note, an FPB is used with a program written in an Arduino language to dynamically control lighting of three 7-segment LEDs (cathode-common) and eight LEDs that are externally connected to the FPB.

The 7-segment LEDs realize a one-minute timer that displays an elapsed time in 100-millisecond (0.1 second) units. Upon the passing of each minute, the eight LEDs are lit in sequence, to realize a timer that can measure times up to nine minutes. Moreover, the timer counting operation can be controlled using a switch (SW_USR) mounted on the FPB or using an externally connected switch (ex_SW).

Table 1.1 shows peripheral functions used in this program and their uses.

Table 1.1 Peripheral functions used and their uses

Peripheral Function	Use
Digital input	Reading the state of the switch (SW_USR) or external switch (ex_SW)
Digital output	Control of the LEDs (three 7-segment LEDs and eight separate LEDs)
Timer array unit	Measurement of the elapsed time

1.1 Program Execution Environment

In this application note, a program in an Arduino language is executed in a development environment specific to the RL78 family. A conceptual diagram of the program execution environment is shown in Figure 1.1.

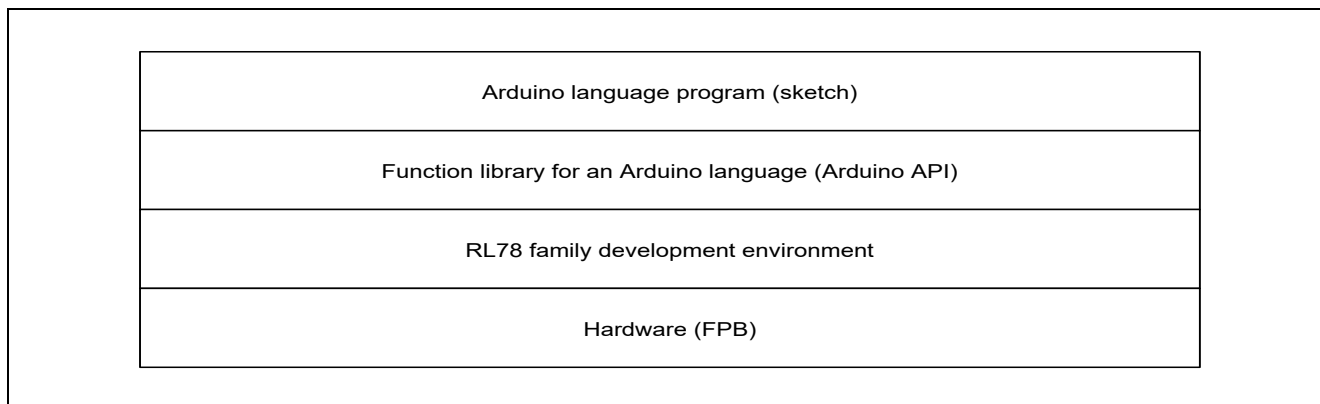

Figure 1.1 Program execution environment

Library functions that can be used in this application note are shown in Table 1.2.

Table 1.2 Library functions

Item	Library Function	Function
Digital I/O	pinMode(pin, mode)	Specifies the operation mode (input mode/output mode/input mode with internal pull-up resistor enabled) for the pin specified by "pin".
	digitalWrite (pin, value)	Sets the pin specified by "pin" to the state specified by "value" (high level/low level).
	digitalRead(pin)	Reads out the state of the pin specified by "pin".
Time control	millis()	Returns, in millisecond units, the time from the start of program execution to the present time.
	micros()	Returns, in microsecond units, the time from the start of program execution to the present time.
	delay (ms)	Stops the program for the specified time in millisecond units.
	delayMicroseconds (us)	Stops the program for the specified time in microsecond units.

1.2 Program (Sketch) Configuration

Subfolders are prepared for each integrated development environment below the folder (workspace) in which the project is stored. In the folders for each of the integrated development environments the files are stored that are used in the RL78 family development environment.

In each sketch subfolder, AR_SKETCH.c is stored which is the Arduino language program (sketch). When viewing or modifying sketch, the "AR_SKETCH.c" file in the sketch subfolder is used.

1.3 Preparations for Project Startup

Preparations for project startup are different depending on the integrated development environment used. For details, refer to the following application note.

RL78 Family Arduino API Introduction Guide (R01AN5413)

1.4 Definitions in the Program (sketch)

Definitions in the program (sketch) are indicated in Figure 1.2.

```

/*-----*-----↓
  Definition area. Write pin definition here.↓
  *-----*/↓
1) int segPinA = 0; // assign D0 pin to segPinA for 7SEG_LED.↓
   int segPinB = 1; // assign D1 pin to segPinB for 7SEG_LED.↓
   int segPinC = 2; // assign D2 pin to segPinC for 7SEG_LED.↓
   int segPinD = 3; // assign D3 pin to segPinD for 7SEG_LED.↓
   int segPinE = 4; // assign D4 pin to segPinE for 7SEG_LED.↓
   int segPinF = 5; // assign D5 pin to segPinF for 7SEG_LED.↓
   int segPinG = 6; // assign D6 pin to segPinG for 7SEG_LED.↓
   int segPinDP = 7; // assign D7 pin to segPinDP for 7SEG_LED.↓
↓
   int comPin0 = 8; // assign D8 pin to comPin0 for 7SEG_LED.↓
   int comPin1 = 9; // assign D9 pin to comPin1 for 7SEG_LED.↓
   int comPin2 = 10; // assign D10 pin to comPin2 for 7SEG_LED.↓
   int comPin3 = 11; // assign D11 pin to comPin3 for DOT_LEDS.↓
↓
   int ex_swPin = 13; // assign D13 pin to ex_swPin for external SW.↓
   int swPin = 18; // assign D18 pin to swPin for SW_USER.↓

2) const int SEG_TABLE[] =↓
   { // segment data table for 7seg_LED↓
     0x3F, // data "0"↓
     0x06, // data "1"↓
     0x5B, // data "2"↓
     0x4F, // data "3"↓
     0x66, // data "4"↓
     0x6D, // data "5"↓
     0x7D, // data "6"↓
     0x27, // data "7"↓
     0x7F, // data "8"↓
     0x6F, // data "9"↓
     0x00, // data " "↓
   };↓

3) int old_time = 0x0000; // previous time(milli sec.)↓
↓
   char mini_data = 0; // minute data 0:1:3:7:F:1F:3F:7F:FF↓
   char sec_data = 0; // second count data(0 to 59)↓
   char precount1 = 0; // prescaler for 100milli seconds. (25)↓
   char precount2 = 0; // prescaler(10) for 1second↓
   char digi_sel = 0; // digit select↓
↓
   char prescale4sw = 0; // prescaler for SW check( up to 5:20milli sec.)↓
   int sw_data = 0xFFFF; // SW data image(history of 20 milli sec. interval)↓
   int time_mode = 0; // 0:stop/1:run↓

```

Figure 1.2 Program definition details

- 1) The digital output pins used to drive segments of the 7-segment LEDs are defined.

0 is specified for the segPinA pin, which controls segment A, allocating this pin to D0.

Similarly, segments B, C, D, E, F, G, and DP are defined.

The digital output pins used to drive commons (for selecting the LED display digits) of the 7-segment LEDs are defined.

8 is specified for the comPin0 pin, which controls the 10-second digit, allocating this pin to D8.

9 is specified for the comPin1 pin, which controls the 1-second digit, allocating this pin to D9.

10 is specified for the comPin2 pin, which controls the 0.1-second digit, allocating this pin to D10.

11 is specified for the comPin3 pin, which controls eight separate LEDs, allocating this pin to D11.

The digital input pins used to read the states of the switches are defined.

13 is specified for the ex_swPin pin, which controls the external switch, allocating this pin to D13.

18 is specified for the swPin pin, which controls the on-board switch (SW_USR), allocating this pin to D18.

- 2) Control data is defined using the array SEG_TABLE, which specifies the numerals (0 to 9) to be displayed by the 7-segment LEDs and specifies where there is no display (LED extinguished).

- 3) A number of variables used in the program (sketch) are defined.

old_time : Variable to confirm the elapsed time (in milliseconds)

sec_data : Variable to count seconds

mini_data : Variable to count minutes

precount1 : Counter variable to obtain 100 milliseconds from the timing of switching of the 4-millisecond display digit

precount2 : Variable to obtain 1 second by counting 100 milliseconds

digi_sel : Variable to control display dynamically

prescale4sw : Variable to count timing to confirm the switch state

sw_data : Variable to store change of the switch state

time_mode : Variable to start/stop counting time

1.5 Initial Setting Processing

The initial settings section of the program (sketch) is shown in Figure 1.3.

In the setup function, input or output mode is specified for each pin.

```

/*-----↓
  Arduino setup area. Write setup program here. ↓
-----*/

↓
void setup(void) {↓
  // put your setup code here, to run once:↓
  pinMode(segPinA, OUTPUT); // set D0pin to output mode↓
  pinMode(segPinB, OUTPUT); // set D1pin to output mode↓
  pinMode(segPinC, OUTPUT); // set D2pin to output mode↓
  pinMode(segPinD, OUTPUT); // set D3pin to output mode↓
  pinMode(segPinE, OUTPUT); // set D4pin to output mode↓
  pinMode(segPinF, OUTPUT); // set D5pin to output mode↓
  pinMode(segPinG, OUTPUT); // set D6pin to output mode↓
  pinMode(segPinDP, OUTPUT); // set D7pin to output mode↓
  pinMode(comPin0, OUTPUT); // set D8pin to output mode↓
  pinMode(comPin1, OUTPUT); // set D9pin to output mode↓
  pinMode(comPin2, OUTPUT); // set D10pin to output mode↓
  pinMode(comPin3, OUTPUT); // set D11pin to output mode↓
  pinMode(ex_swPin, INPUT_PULLUP); // set D13pin to input mode↓
  pinMode(swPin, INPUT); // set D18pin to input mode↓
}↓

```

Figure 1.3 Initial setting processing section

1.6 Main Processing Part

The leading section of the main processing, which is executed repeatedly, is shown in Figure 1.4. When preparations for project startup have been set correctly, the startup screen is as in Figure 1.4.

```

void loop(void) {
  // put your main code here, to run repeatedly:

  int time_work; // present time buffer
  char com_sel; // common select signal
  char seg_data; // segment data
  char sw_work; // work for switch check

  /*-----
    wait for 4milli seconds interval.
  -----*/

  time_work = ( int )( millis() & 0x0FFC ); // read milli sec data

  if ( old_time != time_work ) // check timing of change LED
  {

```

Figure 1.4 Leading section of main processing

2. Operating Conditions

The operation of the sample code provided with this application note has been tested under the following conditions.

Table 2.1 Operating conditions

Item	Description
Microcontroller used	RL78/G14 (R5F104MLAFB)
Operating frequency	<ul style="list-style-type: none"> ● High-speed on-chip oscillator clock (f_{IH}): 32 MHz ● CPU/peripheral hardware clock: 32 MHz
Operating voltage	3.3 V (can be operated at 2.75 V to 5.5 V) LVD operation: Reset mode LVD detection voltage (V_{LVD}) At rising edge: 2.81 V typ. (2.76 V to 2.87 V) At falling edge: 2.75 V typ. (2.70 V to 2.81 V)
Integrated development environment	Renesas Electronics CS+ for CC V8.03.00 Renesas Electronics e ² studio V7.7.0 IAR Systems IAR Embedded Workbench for RL78
C compiler	Renesas Electronics CC-RL V1.09.00 IAR Systems IAR C/C++ Compiler v4.20.1 for RL78

3. Related Application Notes

The application notes related to this application note are shown below.

Refer to these together with this application note.

RL78 Family Arduino API Introduction Guide (R01AN5413)

RL78/G14 Onboard LED Flashing Control (Arduino API) (R01AN5384)

4. Hardware

4.1 Example of Hardware Configuration

Figure 4.1 shows the hardware (FPB) that is used in this application note.

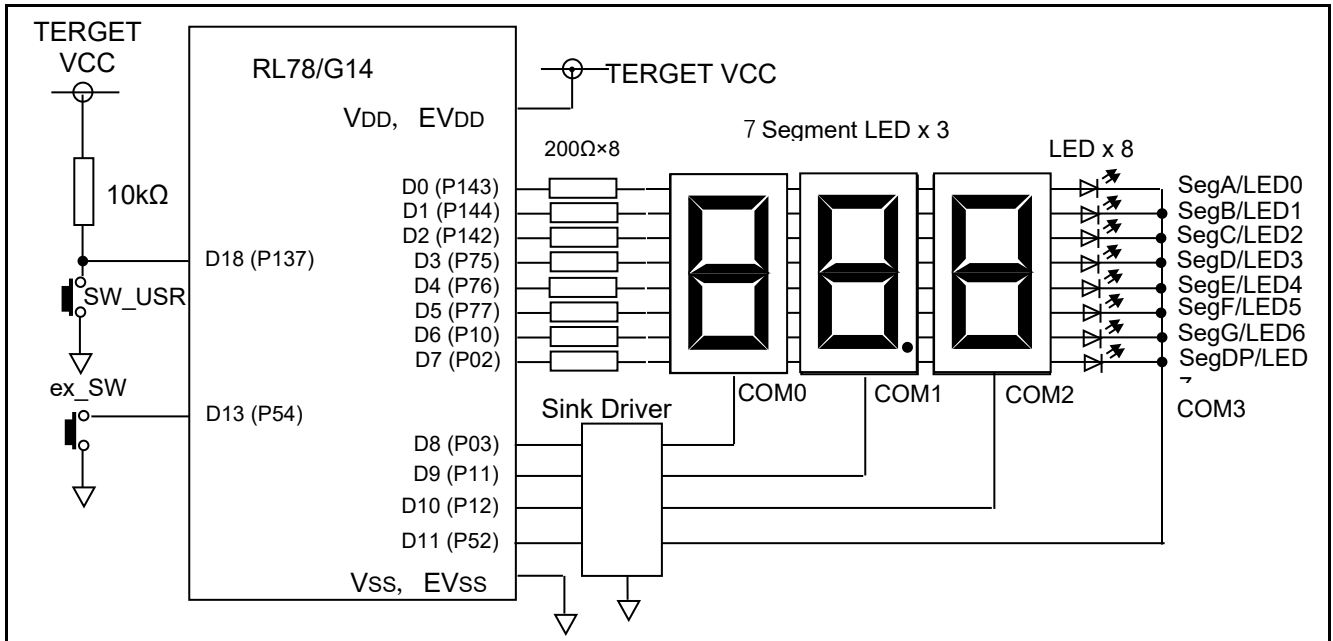

Figure 4.1 Hardware configuration example

Note: This conceptual diagram is simplified in order to summarize the connections.

As the power supply voltage, 3.3 V is supplied via USB.

4.2 List of Pins Used

Table 4.1 shows the pins used and their functions.

Table 4.1 Pins used and their functions

Pin	Port Name	I/O	Function
D16	P43	Output	Control of LED0
D17	P44	Output	Control of LED1
D18	P137	Input	Switch (SW_USR) input

5. Software

5.1 Summary of Operation

In this application note, when the initial settings (pin settings) are completed and the main processing (loop) is started, 7-segment LEDs display "00.0".

When the `ex_SW` or the `SW_USR` switch is pressed, the 7-segment LED display begins counting up. When the `ex_SW` or `SW_USR` switch is again pressed, the counting stops. Thereafter, each time the `ex_SW` or `SW_USR` switch is pressed, counting is resumed or stopped.

When counting upward causes the 7-segment LED display to again return to "00.0", one LED is lit. Each time the 7-segment LED display reaches "00.0", an additional LED is lit. When all eight LEDs are lit and the 7-segment LED display again reaches "00.0", the eight LEDs are all extinguished.

Thereafter, the above operation is repeated.

Details are explained in (1) to (3) below.

(1) Pins to be used are set in the **setup** function.

- The pins (`segPinA` to `segPinDP`) for driving segments of the 7-segment LEDs are set for digital output.
- The pins (`comPin0` to `comPin3`) for driving commons of the 7-segment LEDs are set for digital output.
- The pin (`ex_swPin`) for confirmation of the state of the external switch (`ex_SW`) is set to an input mode in which an internal pull-up resistor is enabled.
- The pin (`swPin`) for confirmation of the state of the on-board switch (`SW_USR`) is set for digital input.

(2) The main processing is performed in the **loop** function.

- 10 bits worth, bits 11 to 2, of the time elapsed from startup (in millisecond units) are acquired.
- It is confirmed that the data acquired has changed from the old data (`old_time`).
- If the data has not changed, processing is ended, and execution returns to the beginning of the loop function.
- If the data has changed (4 milliseconds have elapsed), `old_time` is changed to the acquired data.
- Processing is switched according to the values of bits 3 and 2.

If (bit 3, bit 2) = (0, 0), the `comPin3` pin is set to Low (selection cancelled). Next, segment data for the 10-second digit is determined, and is set at `segPin` using the `set_SEG` function. The display digit specification (the `comPin0` pin) is set to the `com_sel` variable.

If (bit 3, bit 2) = (0, 1), the `comPin0` pin is set to Low (selection cancelled). Next, segment data for the one-second digit is determined, and is set at `segPin` using the `set_SEG` function. At this time, the DP are also set to be lit. The display digit specification (the `comPin1` pin) is set to the `com_sel` variable.

If (bit 3, bit 2) = (1, 0), the `comPin1` pin is set to Low (selection cancelled). Next, segment data for the 100-millisecond digit is determined, and is set at `segPin` using the `set_SEG` function. The display digit specification (the `comPin2` pin) is set to the `com_sel` variable.

If (bit 3, bit 2) = (1, 1), the `comPin2` pin is set to Low (selection cancelled). Next, data for the minute digit is set at `segPin` using the `set_SEG` function. The display digit specification (the `comPin3` pin) is set to the `com_sel` variable.

- The display digit specified by the `com_sel` variable is selected and displayed.

- When counting is permitted (the `time_mode` variable is 1), time counting is performed.
 - The `precount1` variable (4-millisecond units) is counted up, and upon reaching 25 (when 100 milliseconds have elapsed), `precount1` is cleared, and the `precount2` variable (100-millisecond units) is counted up.
 - The `precount2` variable (100-millisecond units) is counted up, and upon reaching 10 (when one second has elapsed), the `precount2` variable is cleared, and the `sec_data` variable (1-second units) is counted up.
 - The `sec_data` variable (1-second units) is counted up, and upon reaching 60 (when one minute has elapsed), the `sec_data` variable is cleared, and the `mini_data` variable (1-minute units) is updated. When the value of `mini_data` is 0xFF, it is set to 0x00. When the value of `mini_data` is not 0xFF, it is shifted one bit to the left, and the LSB (least significant bit) is set (to 1). The value of `mini_data` changes to 0x00, 0x01, 0x03, 0x07, 0x0F, 0x1F, 0x3F, 0x7F, 0xFF.
 - The switch circumstances are checked every 20 milliseconds.
 - The `prescale4sw` variable is counted up, and upon reaching 5 (20 milliseconds), the `prescale4sw` variable is cleared. The `sw_data` variable is shifted one bit to the left, and bit 0 is set to the result of taking the logical sum of the states of the two switches (switches use negative logic, so the logical product is taken). When either of the switches is pressed, the `time_mode` variable is changed.
- (3) In the `poll_sw` function, the state of the **SW_USR** switch is confirmed every **10 milliseconds**, and the number of times the switch is pressed is counted.
- The argument segment data is read into the `work_data` working variable.
 - The LSB (least significant bit) of the `work_data` variable is output to the `segPinA` pin, and the `work_data` variable is shifted one bit to the right.
 - The LSB (least significant bit) of the `work_data` variable is output to the `segPinB` pin, and the `work_data` variable is shifted one bit to the right.
 - The LSB (least significant bit) of the `work_data` variable is output to the `segPinC` pin, and the `work_data` variable is shifted one bit to the right.
 - The LSB (least significant bit) of the `work_data` variable is output to the `segPinD` pin, and the `work_data` variable is shifted one bit to the right.
 - The LSB (least significant bit) of the `work_data` variable is output to the `segPinE` pin, and the `work_data` variable is shifted one bit to the right.
 - The LSB (least significant bit) of the `work_data` variable is output to the `segPinF` pin, and the `work_data` variable is shifted one bit to the right.
 - The LSB (least significant bit) of the `work_data` variable is output to the `segPinG` pin, and the `work_data` variable is shifted one bit to the right.
 - The LSB (least significant bit) of the `work_data` variable is output to the `segPinDP` pin.

5.2 List of Constants

Table 5.1 shows constants that are used in the sample code.

Table 5.1 Constants used in sample code

Constant Name	Setting Value	Description
segPinA	0	Number of the pin to control segment A
segPinB	1	Number of the pin to control segment B
segPinC	2	Number of the pin to control segment C
segPinD	3	Number of the pin to control segment D
segPinE	4	Number of the pin to control segment E
segPinF	5	Number of the pin to control segment F
segPinG	6	Number of the pin to control segment G
segPinDP	7	Number of the pin to control segment DP
comPin0	8	Number of the pin to select the 10-second digit
comPin1	9	Number of the pin to select the 1-second digit
comPin2	10	Number of the pin to select the 100-millisecond digit
comPin3	11	Number of the pin to select separate LED
ex_swPin	13	Number of the pin that reads external switch (ex_SW)
swPin	18	Number of the pin that reads SW_USR
SEG_TABLE[]	0x3F	Data to display 0 in a 7-segment LED
	0x06	Data to display 1 in a 7-segment LED
	0x5B	Data to display 2 in a 7-segment LED
	0x4F	Data to display 3 in a 7-segment LED
	0x66	Data to display 4 in a 7-segment LED
	0x6D	Data to display 5 in a 7-segment LED
	0x7D	Data to display 6 in a 7-segment LED
	0x27	Data to display 7 in a 7-segment LED
	0x7F	Data to display 8 in a 7-segment LED
	0x6F	Data to display 9 in a 7-segment LED
	0x00	Data to extinguish a 7-segment LED
HIGH	0x01	High level
LOW	0x00	Low level

5.3 List of Variables

Table 5.1 lists global variables.

Table 5.2 Global variables

Type	Variable Name	Description	Function used
int	old_time	Time elapsed time from previous startup (in millisecond units)	loop()
char	mini_data	Data indicating minutes elapsed: 0x00/0x01/0x03/0x07/0x0F/0x1F/0x3F/0x7F/0xFF	loop()
char	sec_data	Second data	loop()
char	precount1	Used to generate 100-millisecond timing (updated every 4 milliseconds)	loop()
char	Precount2	Used to generate 1-second timing (updated every 100 milliseconds)	loop()
char	digi_sel	Specifies the digit to display (pin numbers: 8 to 11).	loop()
char	prescale4sw	Used to generate 20-second timing	loop()
Int	sw_data	Stores state changes of the switch (initial value is 0xFF).	loop()
Int	time_mode	Flag to control time counting (0: do not count, 1: count)	loop()

5.4 List of Functions

Table 5.3 shows a list of functions.

Table 5.3 List of functions

Function Name	Overview
loop	Main processing (sketch)
setup	Initialization function (sketch)
set_SEG	Function to set display data for 7-segment LEDs (sketch)
pinMode	Specifies the operation mode of a pin (input mode/output mode/input mode with internal pull-up resistor enabled).
digitalWrite	Outputs data to a pin.
digitalRead	Reads the state of a pin.
micros	Returns the time, in microsecond units, from the start of program execution until the present time.
millis	Returns the time, in millisecond units, from the start of program execution until the present time.
delay	Stops the program for the specified time, in millisecond units.
delayMicroseconds	Stops the program for the specified time, in microsecond units.

[Function name] digitalWrite

Overview	Function to output digital data to a pin	
Header	AR_LIB_PORT.h, r_cg_macrodriver.h, r_cg_userdefine.h	
Declaration	void digitalWrite(uint8_t pin, uint8_t value);	
Description	The data indicated by the second argument is output to the pin indicated by the first argument.	
Argument	uint8_t pin :	Number of the pin for data output
	uint8_t value :	Data to output (HIGH/LOW)
Return value	None	

[Function name] digitalRead

Overview	Function to read out digital data from a pin	
Header	AR_LIB_PORT.h, r_cg_macrodriver.h, r_cg_userdefine.h	
Declaration	uint8_t digitalRead(uint8_t pin);	
Description	The state of the pin specified by the argument is read out	
Argument	uint8_t pin :	Number of the pin to be read out
Return value	uint8_t :	Data that was read out (HIGH/LOW)

[Function name] millis

Overview	Function to obtain the elapsed time in millisecond units	
Header	AR_LIB_TIME.h, r_cg_macrodriver.h, r_cg_userdefine.h	
Declaration	uint32_t millis (void);	
Description	Returns the time elapsed from startup, in millisecond units.	
Argument	None	
Return value	uint32_t :	Elapsed time in millisecond units

5.6 Flowcharts

5.6.1 Initial setting function

Figure 5.1 and Figure 5.2 show flowcharts of the initial setting.

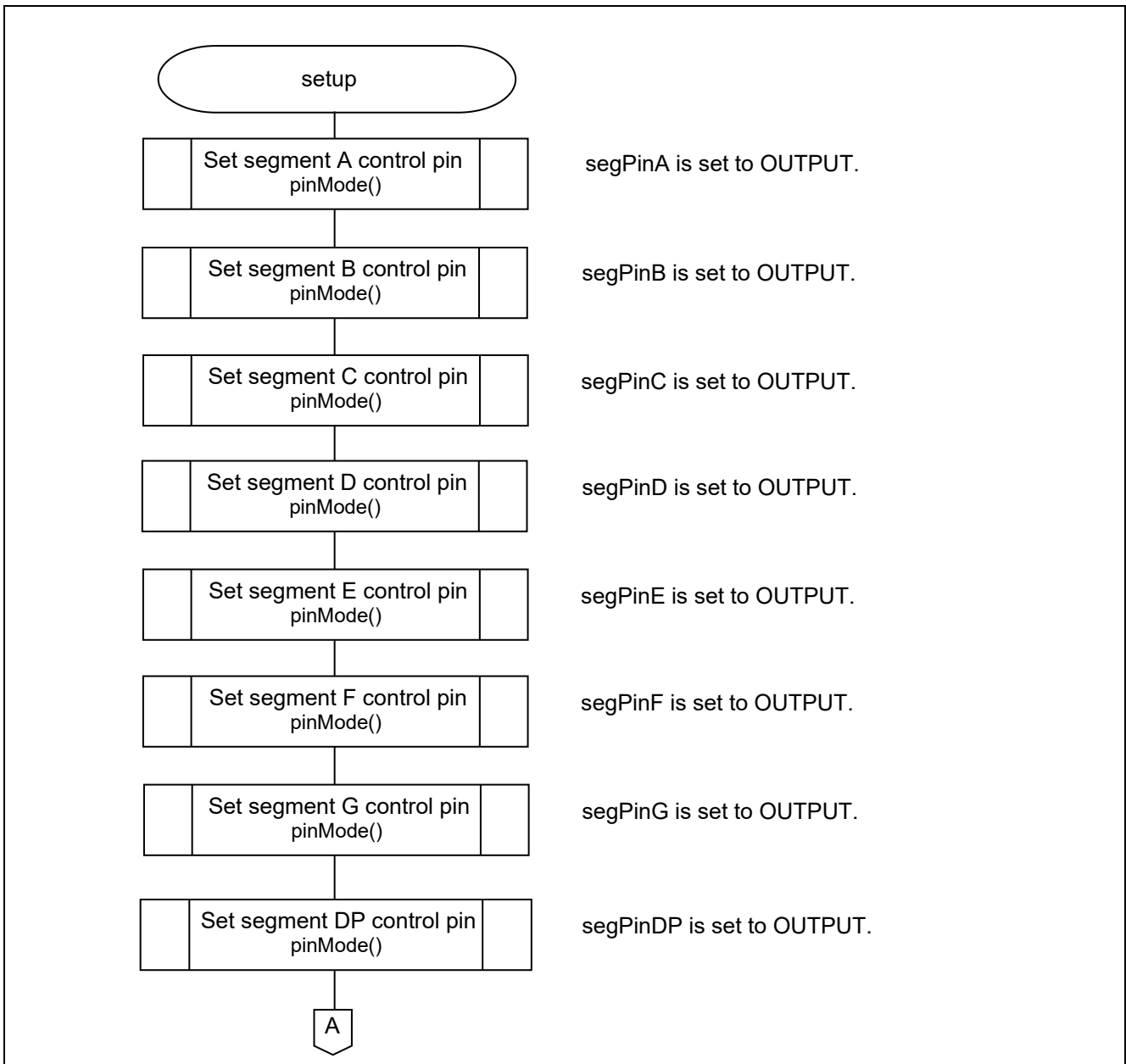

Figure 5.1 Initial setting function (1/2)

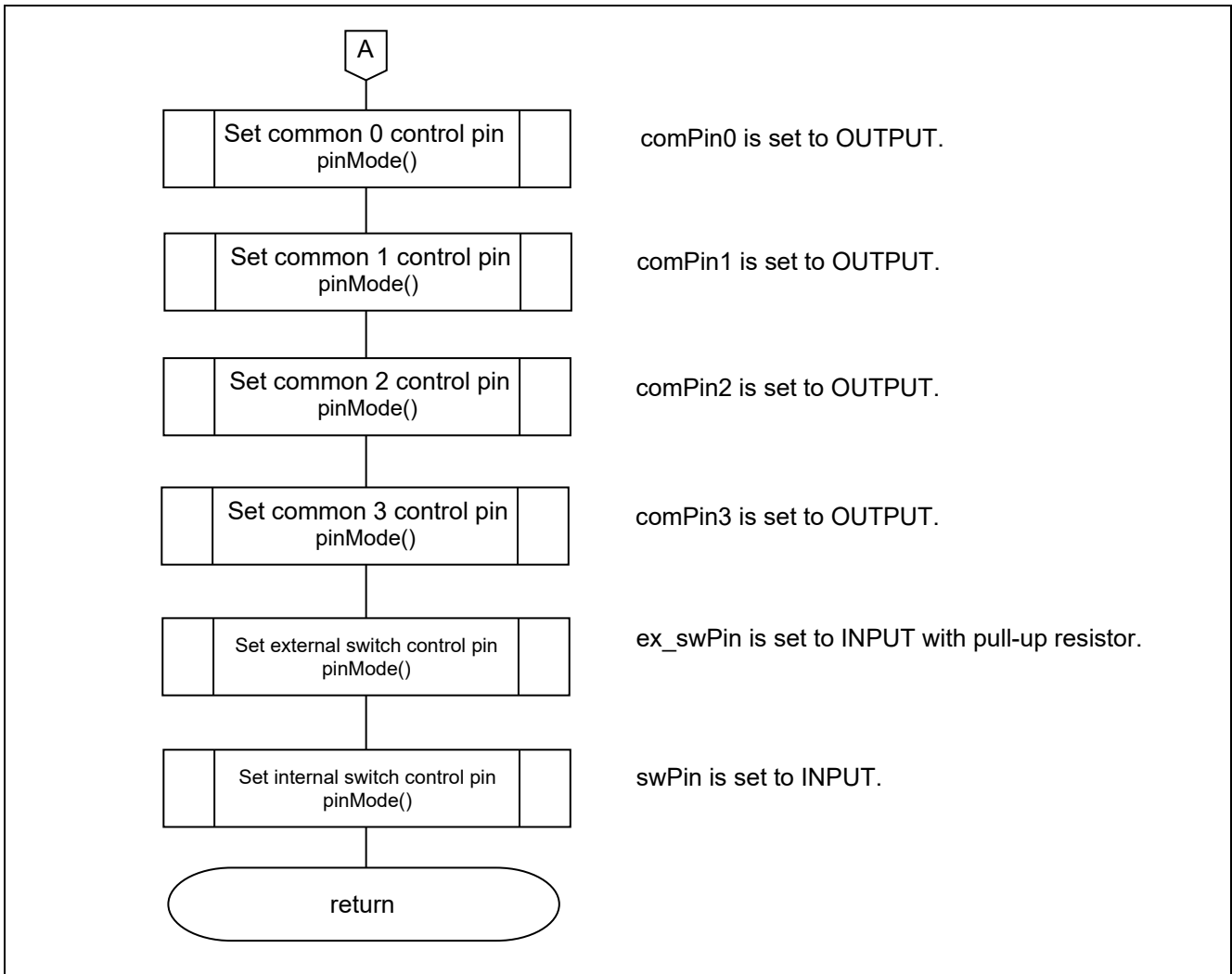

Figure 5.2 Initial setting function (2/2)

5.6.2 Main Processing Function

Figure 5.3 to Figure 5.6 show flowcharts of the main processing function.

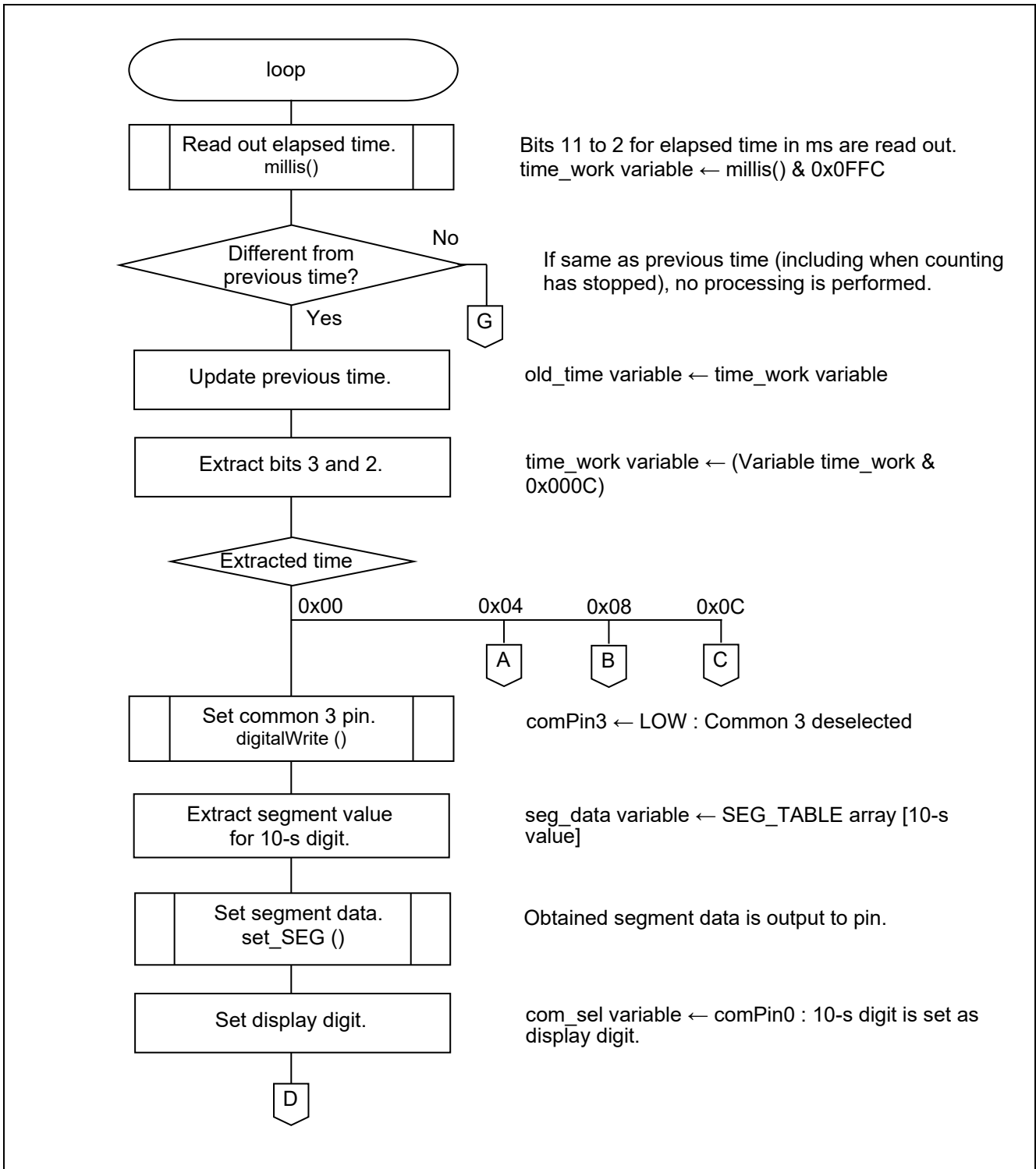

Figure 5.3 Main processing function (1/4)

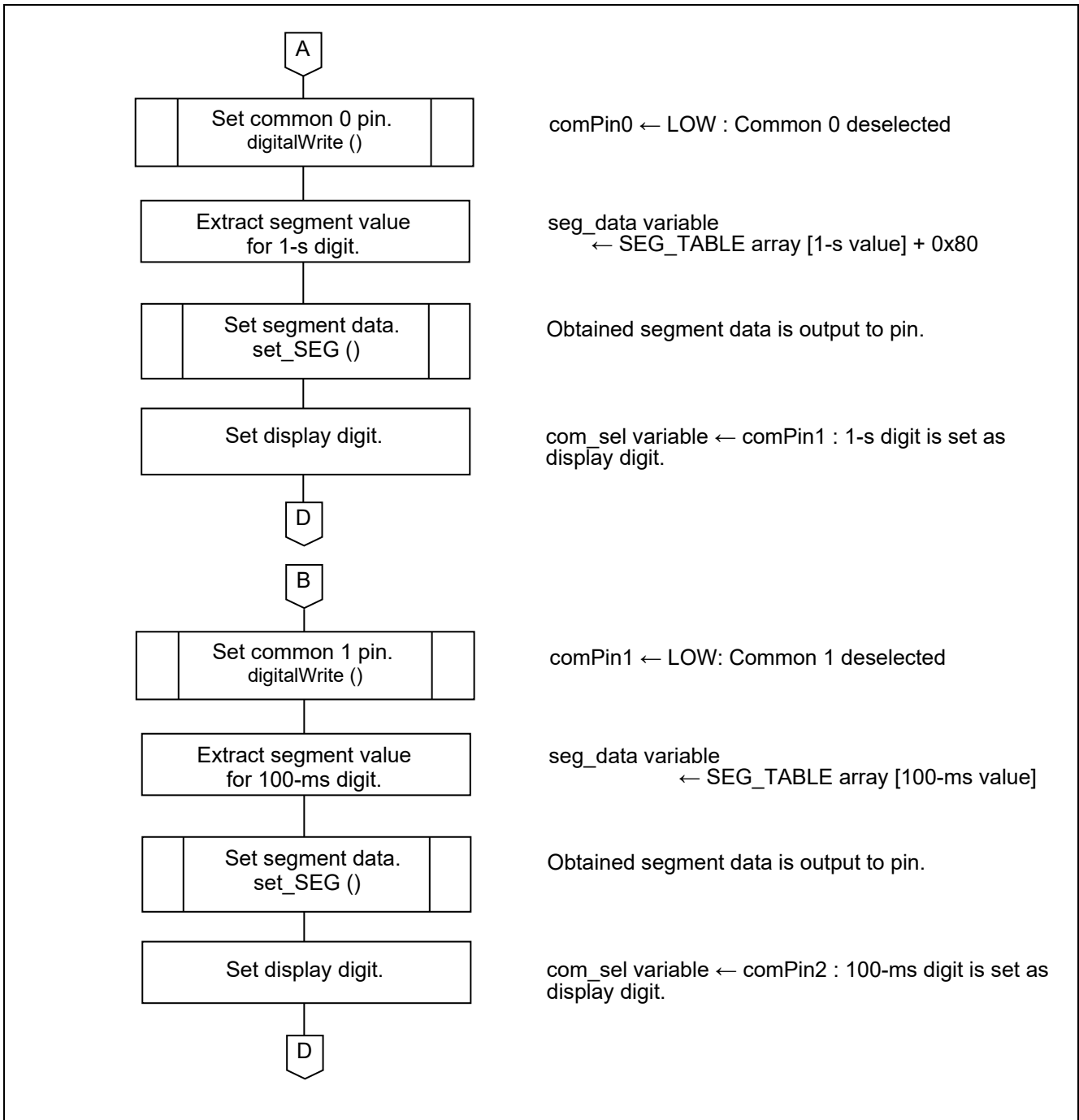

Figure 5.4 Main processing function (2/4)

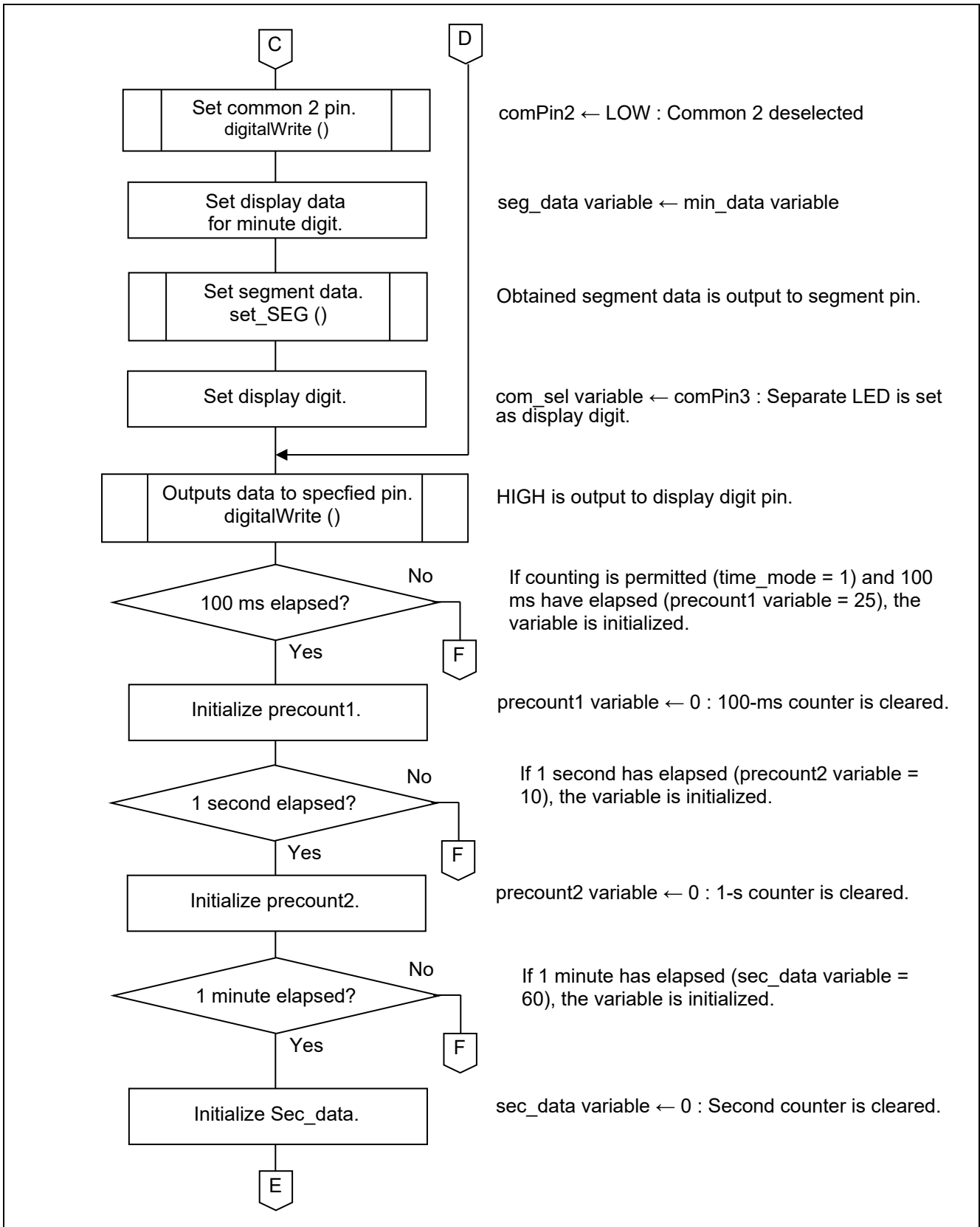

Figure 5.5 Main processing function (3/4)

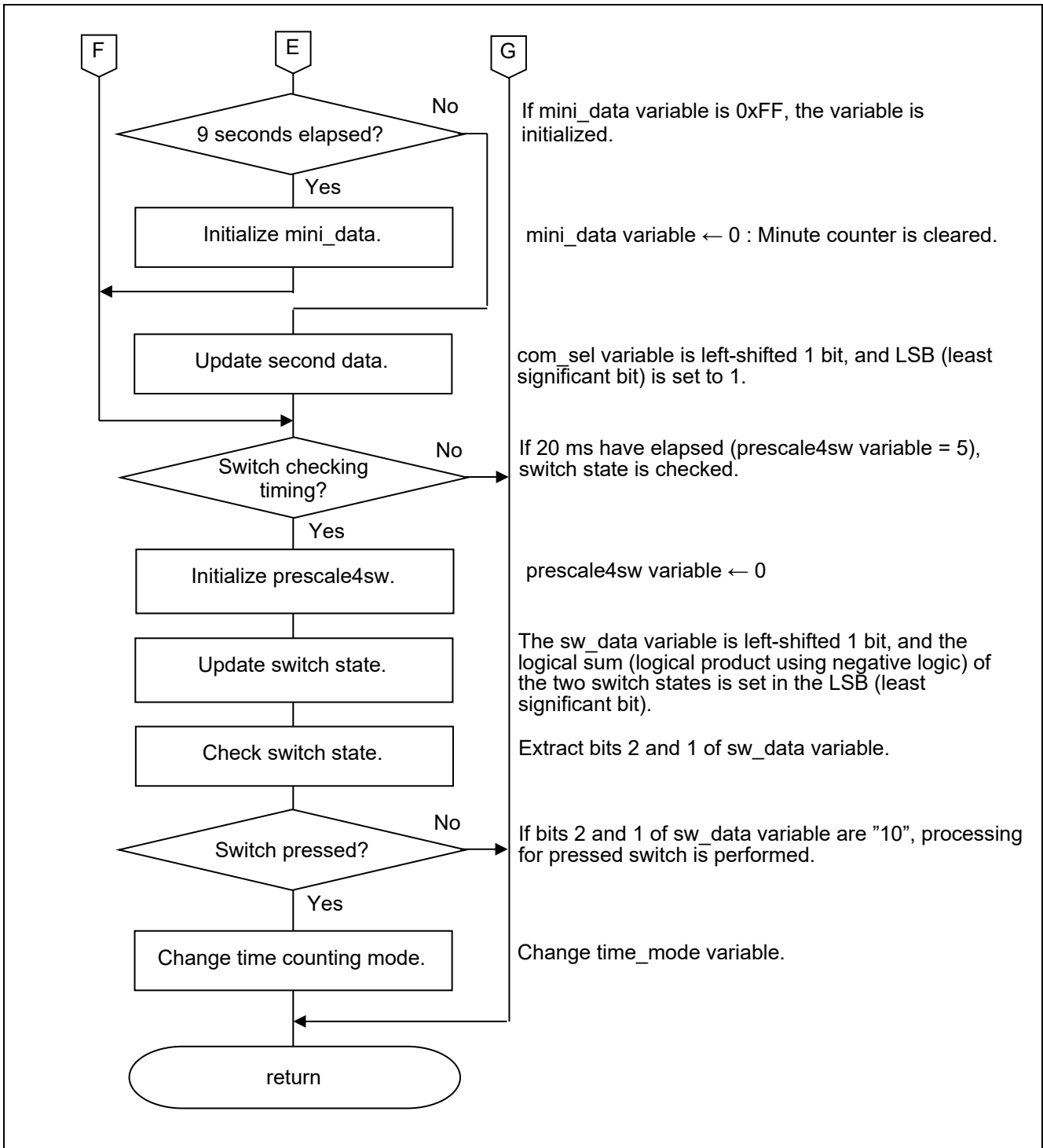

Figure 5.6 Main processing function (4/4)

5.6.3 Function to set display data for 7-segment LEDs

Figure 5.7 and Figure 5.8 show flowcharts of the function to set display data for 7-segment LEDs.

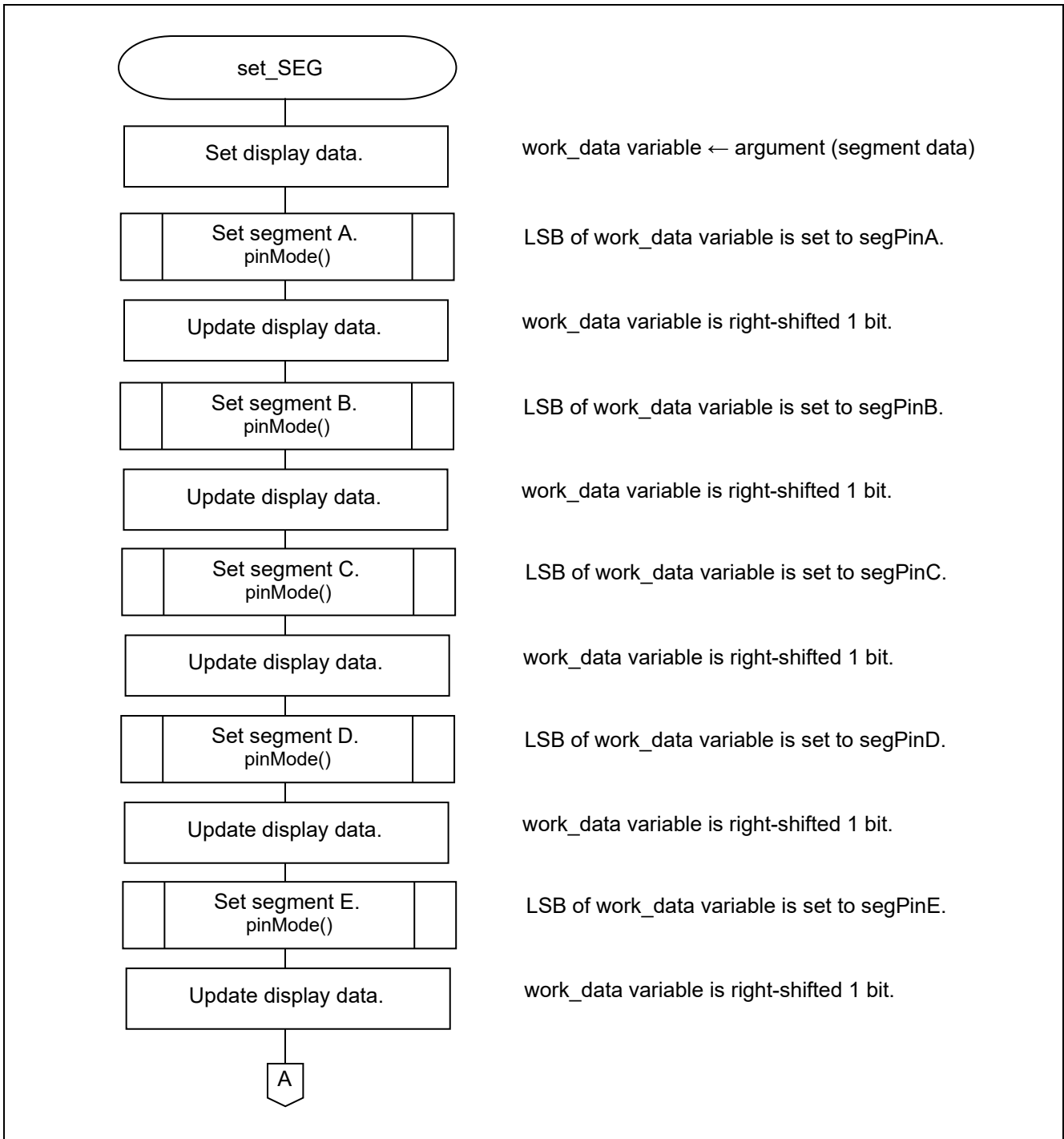

Figure 5.7 Function to set display data for Segment LEDs (1/2)

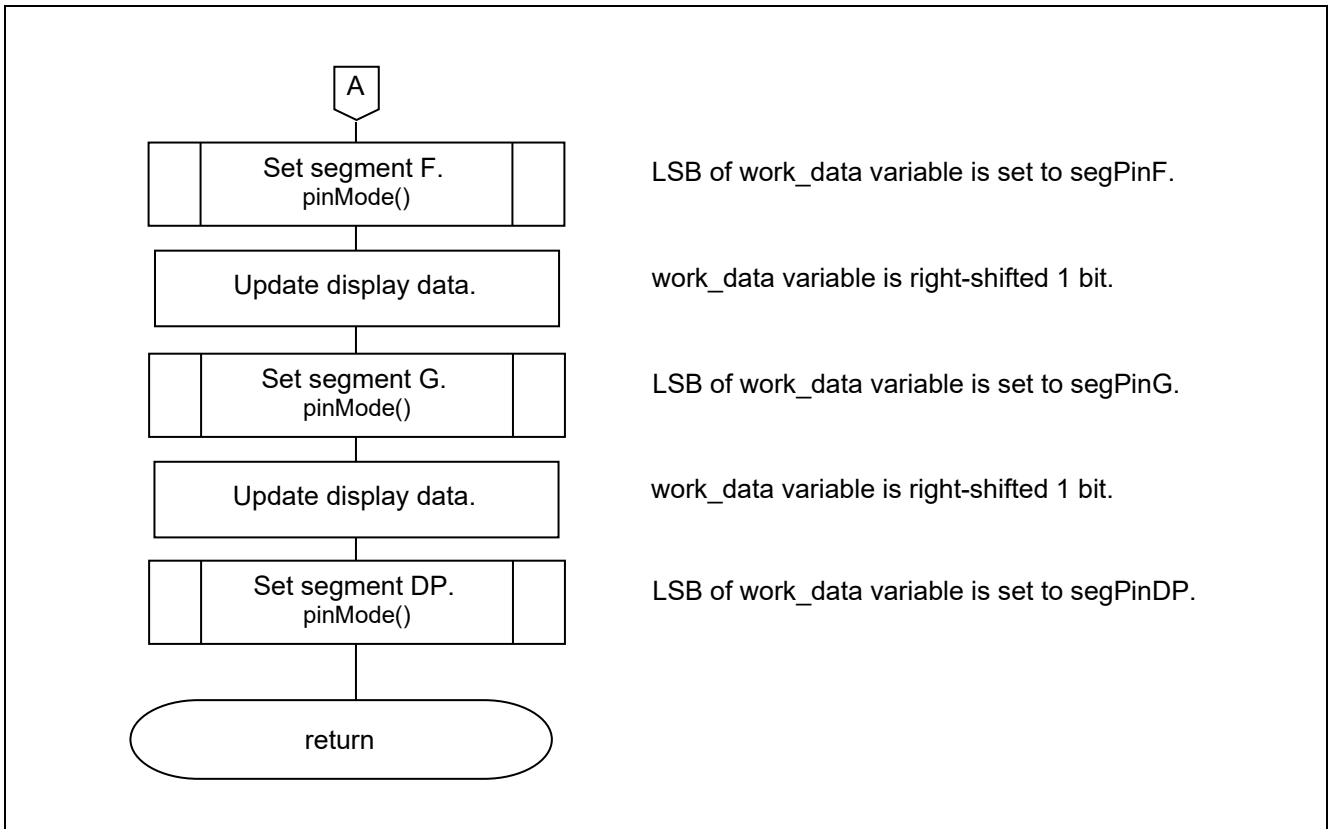

Figure 5.8 Function to set display data for Segment LEDs (2/2)

6. Sample Code

Sample code can be downloaded from the Renesas Electronics website.

7. Reference Documents

RL78/G14 User's Manual: Hardware (R01UH0186)

RL78 family User's Manual: Software (R01US0015)

RL78/G14 Fast Prototyping Board User's Manual (R20UT4573)

RL78 Family Arduino API Introduction Guide (R01AN5413)

(The latest versions can be downloaded from the Renesas Electronics website.)

Technical Update/Technical News

(The latest versions can be downloaded from the Renesas Electronics website.)

Website and Support

Renesas Electronics Website

<http://www.renesas.com/>

Inquiries

<http://www.renesas.com/contact/>

Revision History

Rev.	Date	Description	
		Page	Summary
1.00	July.10.20	—	First Edition

General Precautions in the Handling of Microprocessing Unit and Microcontroller Unit Products

The following usage notes are applicable to all Microprocessing unit and Microcontroller unit products from Renesas. For detailed usage notes on the products covered by this document, refer to the relevant sections of the document as well as any technical updates that have been issued for the products.

1. Precaution against Electrostatic Discharge (ESD)

A strong electrical field, when exposed to a CMOS device, can cause destruction of the gate oxide and ultimately degrade the device operation. Steps must be taken to stop the generation of static electricity as much as possible, and quickly dissipate it when it occurs. Environmental control must be adequate. When it is dry, a humidifier should be used. This is recommended to avoid using insulators that can easily build up static electricity.

Semiconductor devices must be stored and transported in an anti-static container, static shielding bag or conductive material. All test and measurement tools including work benches and floors must be grounded. The operator must also be grounded using a wrist strap. Semiconductor devices must not be touched with bare hands. Similar precautions must be taken for printed circuit boards with mounted semiconductor devices.

2. Processing at power-on

The state of the product is undefined at the time when power is supplied. The states of internal circuits in the LSI are indeterminate and the states of register settings and pins are undefined at the time when power is supplied. In a finished product where the reset signal is applied to the external reset pin, the states of pins are not guaranteed from the time when power is supplied until the reset process is completed. In a similar way, the states of pins in a product that is reset by an on-chip power-on reset function are not guaranteed from the time when power is supplied until the power reaches the level at which resetting is specified.

3. Input of signal during power-off state

Do not input signals or an I/O pull-up power supply while the device is powered off. The current injection that results from input of such a signal or I/O pull-up power supply may cause malfunction and the abnormal current that passes in the device at this time may cause degradation of internal elements. Follow the guideline for input signal during power-off state as described in your product documentation.

4. Handling of unused pins

Handle unused pins in accordance with the directions given under handling of unused pins in the manual. The input pins of CMOS products are generally in the high-impedance state. In operation with an unused pin in the open-circuit state, extra electromagnetic noise is induced in the vicinity of the LSI, an associated shoot-through current flows internally, and malfunctions occur due to the false recognition of the pin state as an input signal become possible.

5. Clock signals

After applying a reset, only release the reset line after the operating clock signal becomes stable. When switching the clock signal during program execution, wait until the target clock signal is stabilized. When the clock signal is generated with an external resonator or from an external oscillator during a reset, ensure that the reset line is only released after full stabilization of the clock signal. Additionally, when switching to a clock signal produced with an external resonator or by an external oscillator while program execution is in progress, wait until the target clock signal is stable.

6. Voltage application waveform at input pin

Waveform distortion due to input noise or a reflected wave may cause malfunction. If the input of the CMOS device stays in the area between V_{IL} (Max.) and V_{IH} (Min.) due to noise, for example, the device may malfunction. Take care to prevent chattering noise from entering the device when the input level is fixed, and also in the transition period when the input level passes through the area between V_{IL} (Max.) and V_{IH} (Min.).

7. Prohibition of access to reserved addresses

Access to reserved addresses is prohibited. The reserved addresses are provided for possible future expansion of functions. Do not access these addresses as the correct operation of the LSI is not guaranteed.

8. Differences between products

Before changing from one product to another, for example to a product with a different part number, confirm that the change will not lead to problems. The characteristics of a microprocessing unit or microcontroller unit products in the same group but having a different part number might differ in terms of internal memory capacity, layout pattern, and other factors, which can affect the ranges of electrical characteristics, such as characteristic values, operating margins, immunity to noise, and amount of radiated noise. When changing to a product with a different part number, implement a system-evaluation test for the given product.

Notice

1. Descriptions of circuits, software and other related information in this document are provided only to illustrate the operation of semiconductor products and application examples. You are fully responsible for the incorporation or any other use of the circuits, software, and information in the design of your product or system. Renesas Electronics disclaims any and all liability for any losses and damages incurred by you or third parties arising from the use of these circuits, software, or information.
 2. Renesas Electronics hereby expressly disclaims any warranties against and liability for infringement or any other claims involving patents, copyrights, or other intellectual property rights of third parties, by or arising from the use of Renesas Electronics products or technical information described in this document, including but not limited to, the product data, drawings, charts, programs, algorithms, and application examples.
 3. No license, express, implied or otherwise, is granted hereby under any patents, copyrights or other intellectual property rights of Renesas Electronics or others.
 4. You shall not alter, modify, copy, or reverse engineer any Renesas Electronics product, whether in whole or in part. Renesas Electronics disclaims any and all liability for any losses or damages incurred by you or third parties arising from such alteration, modification, copying or reverse engineering.
 5. Renesas Electronics products are classified according to the following two quality grades: "Standard" and "High Quality". The intended applications for each Renesas Electronics product depends on the product's quality grade, as indicated below.
 - "Standard": Computers; office equipment; communications equipment; test and measurement equipment; audio and visual equipment; home electronic appliances; machine tools; personal electronic equipment; industrial robots; etc.
 - "High Quality": Transportation equipment (automobiles, trains, ships, etc.); traffic control (traffic lights); large-scale communication equipment; key financial terminal systems; safety control equipment; etc.
- Unless expressly designated as a high reliability product or a product for harsh environments in a Renesas Electronics data sheet or other Renesas Electronics document, Renesas Electronics products are not intended or authorized for use in products or systems that may pose a direct threat to human life or bodily injury (artificial life support devices or systems; surgical implantations; etc.), or may cause serious property damage (space system; undersea repeaters; nuclear power control systems; aircraft control systems; key plant systems; military equipment; etc.). Renesas Electronics disclaims any and all liability for any damages or losses incurred by you or any third parties arising from the use of any Renesas Electronics product that is inconsistent with any Renesas Electronics data sheet, user's manual or other Renesas Electronics document.
6. When using Renesas Electronics products, refer to the latest product information (data sheets, user's manuals, application notes, "General Notes for Handling and Using Semiconductor Devices" in the reliability handbook, etc.), and ensure that usage conditions are within the ranges specified by Renesas Electronics with respect to maximum ratings, operating power supply voltage range, heat dissipation characteristics, installation, etc. Renesas Electronics disclaims any and all liability for any malfunctions, failure or accident arising out of the use of Renesas Electronics products outside of such specified ranges.
 7. Although Renesas Electronics endeavors to improve the quality and reliability of Renesas Electronics products, semiconductor products have specific characteristics, such as the occurrence of failure at a certain rate and malfunctions under certain use conditions. Unless designated as a high reliability product or a product for harsh environments in a Renesas Electronics data sheet or other Renesas Electronics document, Renesas Electronics products are not subject to radiation resistance design. You are responsible for implementing safety measures to guard against the possibility of bodily injury, injury or damage caused by fire, and/or danger to the public in the event of a failure or malfunction of Renesas Electronics products, such as safety design for hardware and software, including but not limited to redundancy, fire control and malfunction prevention, appropriate treatment for aging degradation or any other appropriate measures. Because the evaluation of microcomputer software alone is very difficult and impractical, you are responsible for evaluating the safety of the final products or systems manufactured by you.
 8. Please contact a Renesas Electronics sales office for details as to environmental matters such as the environmental compatibility of each Renesas Electronics product. You are responsible for carefully and sufficiently investigating applicable laws and regulations that regulate the inclusion or use of controlled substances, including without limitation, the EU RoHS Directive, and using Renesas Electronics products in compliance with all these applicable laws and regulations. Renesas Electronics disclaims any and all liability for damages or losses occurring as a result of your noncompliance with applicable laws and regulations.
 9. Renesas Electronics products and technologies shall not be used for or incorporated into any products or systems whose manufacture, use, or sale is prohibited under any applicable domestic or foreign laws or regulations. You shall comply with any applicable export control laws and regulations promulgated and administered by the governments of any countries asserting jurisdiction over the parties or transactions.
 10. It is the responsibility of the buyer or distributor of Renesas Electronics products, or any other party who distributes, disposes of, or otherwise sells or transfers the product to a third party, to notify such third party in advance of the contents and conditions set forth in this document.
 11. This document shall not be reprinted, reproduced or duplicated in any form, in whole or in part, without prior written consent of Renesas Electronics.
 12. Please contact a Renesas Electronics sales office if you have any questions regarding the information contained in this document or Renesas Electronics products.

(Note1) "Renesas Electronics" as used in this document means Renesas Electronics Corporation and also includes its directly or indirectly controlled subsidiaries.

(Note2) "Renesas Electronics product(s)" means any product developed or manufactured by or for Renesas Electronics.

(Rev.4.0-1 November 2017)

Corporate Headquarters

TOYOSU FORESIA, 3-2-24 Toyosu,
Koto-ku, Tokyo 135-0061, Japan
www.renesas.com

Trademarks

Renesas and the Renesas logo are trademarks of Renesas Electronics Corporation. All trademarks and registered trademarks are the property of their respective owners.

Contact information

For further information on a product, technology, the most up-to-date version of a document, or your nearest sales office, please visit:
www.renesas.com/contact/.