RZ/G2L Evaluation Board Kit

This document provides quick-start instructions for how to bring up an RZ/G2L Evaluation Board Kit (EVK), and how to boot Linux® by using the RZ/G2L Verified Linux Package (VLP) pre-built image.

Important: To ensure the RZ/G2L EVK is set up correctly, complete the steps in the order listed in “Quick Start Procedure”.

Contents

1. EVK Information	2
1.1 How to Get the EVK	2
1.2 EVK Contents	2
2. Quick Start Procedure	3
2.1 Run the “Pre-built” Image	3
2.1.1. Prepare the microSD Card.....	3
2.1.2. Write the Bootloader and U-boot	4
2.1.2.1. Prepare the Hardware.....	5
2.1.2.2. Prepare for Serial Communication.....	6
2.1.2.3. Send the Flash Writer	8
2.1.2.4. Write the Bootloader	9
2.1.3. Start Up Linux	11
2.2 Build the Linux Environment.....	13
3. Revision History	13

1. EVK Information

1.1 How to Get the EVK

To obtain the RZ/G2L EVK, go to the RZ/G2L EVK [RTK9744L23S01000BE](https://www.renesas.com/en/products/processors/microprocessors/rz-g2l-evk) product page and click on “Buy/Quote” under Product Options ([Buy Direct](#)). If requesting to buy the RZ/G2L Secure Type, please contact us.

1.2 EVK Contents

The RZ/G2L EVK is the most suitable board kit for RZ/G2L evaluation. The EVK consists of a module board and a common carrier board.

The EVK conforms to the SMARC v2.1 standard, and is comprised of the following:

- RZ/G2L Module Board (SMARC2.1)
- Common Carrier Board
- USB Cable (USB Type-A- Micro USB Type-B)



Figure 1. RZ/G2L Evaluation Board Kit

Customers must purchase the following items separately:

- USB type C charger 65W
 - Support USB PD, QC
 - Output specification: 5V3A,9V3A,15V3A,20V3.25A
- USB type C to type C cable
 - USB-C and USB-C 3.1 Gen2 USB-PD support 100W
- micro SD UHI-Class10 (8GB or more)

In addition, please prepare Windows PC (Windows 10 or Windows 11) for your host PC to program the root loader files to EVK.

If you would like to display the capture image of USB camera on HDMI Display in the section 2.1.4, please prepare the following item additionally.

- USB camera (support UVC)
- HDMI Display
- Micro-HDMI to HDMI cable

2. Quick Start Procedure

Complete the following quick-start steps in the order listed.

2.1 Run the “Pre-built” Image

After obtaining the RZ/G2L EVK, download the RZ/G2L VLP pre-built image and try running it.

Please download the [RZ/G2L VLP3.0.6 Pre-built Images_EN.zip](#) file and decompress the file on your PC.

2.1.1. Prepare the microSD Card

Write the “Images_RZ/G2L_v3.0.6.zip” file, which is included in the “RZ/G2L_VLP3.0.6_Pre-built_Images_EN.zip,” to your microSD card.

Option 1: Use Windows® PC

1. Copy the “Images_RZG2L_v3.0.6.zip” to a Windows PC and unzip it.
2. Write the microSD card image (core-image-qt-smarc-rzg2l.wic.gz) to an SD card that has a 2GB or more capacity by using a tool similar to either of the following:
 - Win32 Disk Imager ([Win32 Disk Imager download | SourceForge.net](#))
 - balenaEtcher ([balenaEtcher - Flash OS images to SD cards & USB drives](#))

Note: If the following message is displayed after inserting the microSD card in the Window PC, or after writing the image to the microSD card, please select “Cancel.”

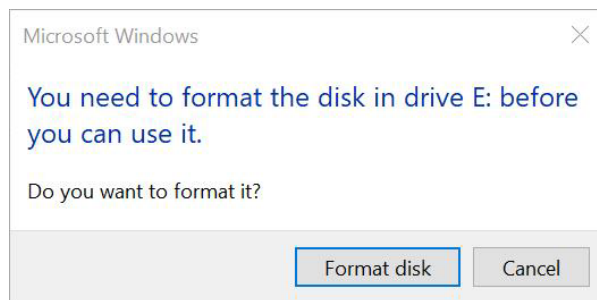

Option 2: Use Linux® Host PC

If you would like to program the image to your microSD card using a Linux Host PC, see following steps.

Prepare the microSD card by entering the following commands on your Linux PC:

1. Unzip the “Images_RZG2L_v3.0.6.zip” file to get the “core-image-qt-smarc-rzg2l.wic.gz” and “core-image-qt-smarc-rzg2l.wic.bmap”.
2. Check the microSD Card Device Name: enter the **lsblk** command before and after inserting your microSD card.

Note: Be careful not to use other device names (**sdb** is used in this document).

<before inserting microSD card>

```
$ lsblk
NAME MAJ:MIN RM SIZE RO TYPE MOUNTPOINT
sda 8:0 0 30.9G 0 disk
├─sda1 8:1 0 512M 0 part /boot/efi
├─sda2 8:2 0 1K 0 part
└─sda5 8:5 0 30.3G 0 part /
sr0 11:0 1 1024M 0 rom
```

then...

<after inserting microSD card>

```
$ lsblk
NAME MAJ:MIN RM SIZE RO TYPE MOUNTPOINT
sda 8:0 0 30.9G 0 disk
├─sda1 8:1 0 512M 0 part /boot/efi
├─sda2 8:2 0 1K 0 part
└─sda5 8:5 0 30.3G 0 part /
sdb 8:16 1 29.7G 0 disk
└─sdb1 8:17 1 29.7G 0 part
sr0 11:0 1 1024M 0 rom
```

3. Unmount the SD card partitions mounted automatically.
/dev/sdb is an example and the actual partitions path depend on your environment.

```
$ sudo umount /dev/sdb
```

4. Using the device name found above, write the image file into the microSD card using the following commands. Put “core-image-qt-smarc-rzg2l.wic.gz” and “core-image-qt-smarc-rzg2l.wic.bmap” on the same working directory.

```
$ sudo apt-get install bmap-tools
$ sudo bmaptool copy core-image-qt-smarc-rzg2l.wic.gz /dev/sdb
```

5. Remove and insert the microSD card again to confirm that the image file has been successfully written to the microSD card.

2.1.2. Write the Bootloader and U-boot

Copy “Flash_Writer_SCIF_RZG2L_SMARC_PMIC_DDR4_2GB_1PCS.mot”, “bl2_bp-smarc-rzg2l_pmic.srec”, and “fip-smarc-rzg2l_pmic.srec” included in the first partition “boot” of SD card prepared by Step2-1 to your PC.

Main Specification of the EVK

The components of the RZ/G2L EVK that are used in this step include the following.

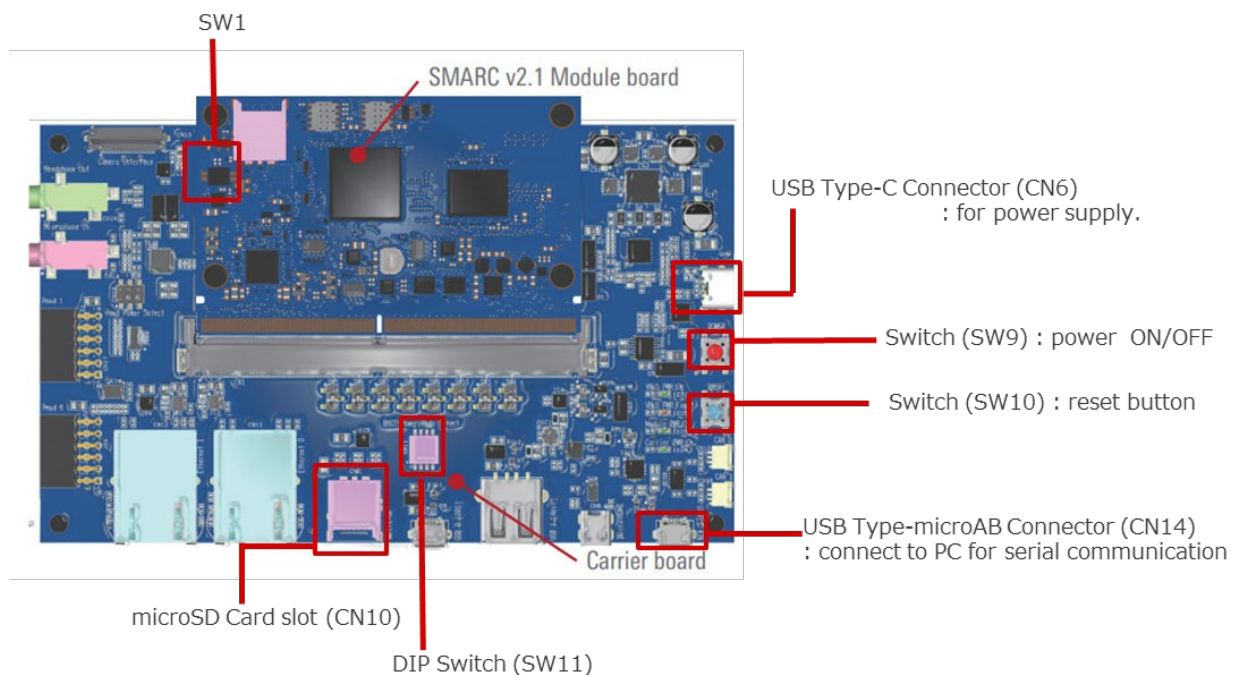

2.1.2.1. Prepare the Hardware

1. Attach the power-delivery (PD) capable USB Type-C cable to the USB Type-C port (“Power input”). The LEDs (“VBUS_PWR_ON” and “Module_PWR_ON”) should now be illuminated.

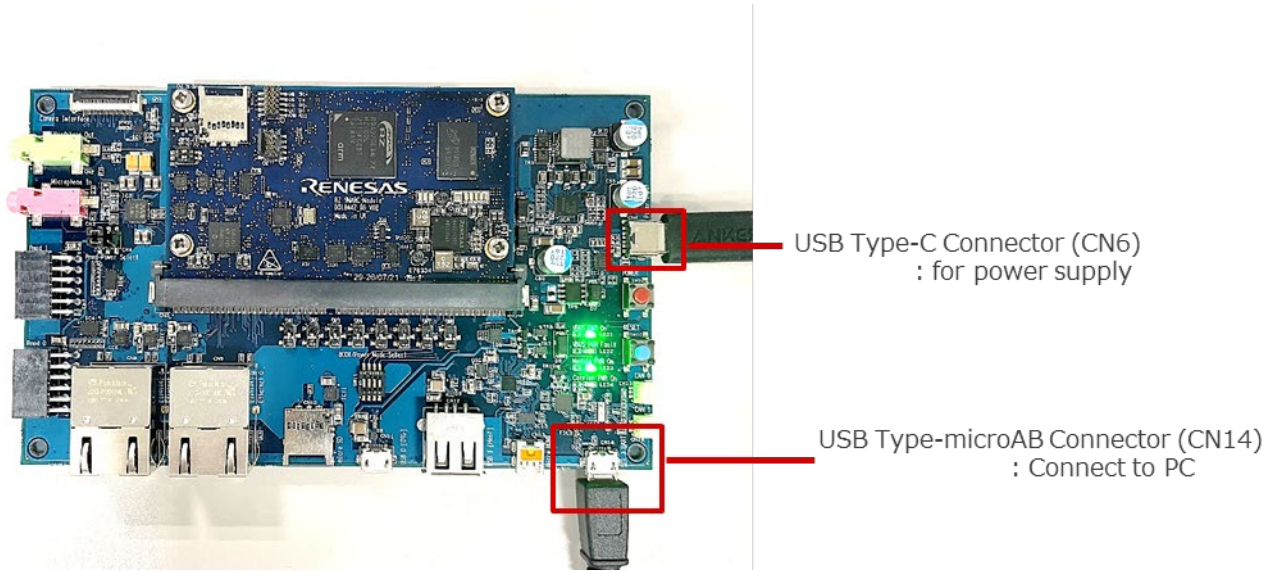

2. Set the board to SCIF Download mode to write to the serial flash memory on the EVK board. In addition, set the SW11 and SW1 as follows.

SW11 (SCIF Download mode)

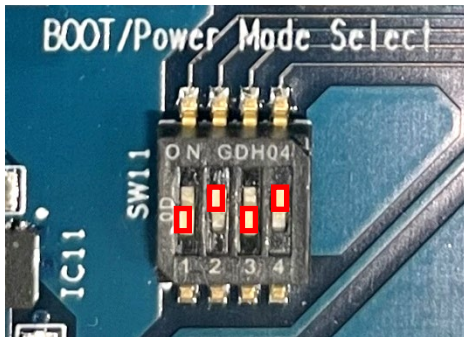

SW11-1	SW11-2	SW11-3	SW11-4
OFF	ON	OFF	ON

SW1 (Select eMMC)

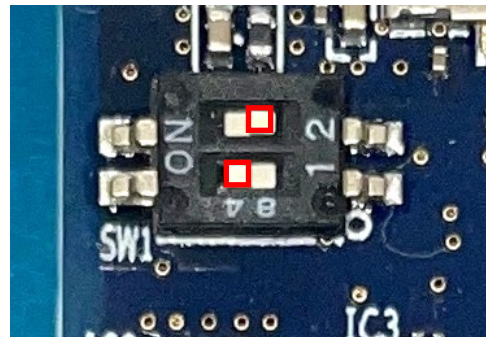

SW1-1	SW1-2
ON	OFF

- Press the red button (SW9) to turn on the power. The LED4 (Carrier PWR On) should illuminate. When turning off the power, press and hold the red button for 2 seconds then check that the LED4 (Carrier PWR On) is turned off.

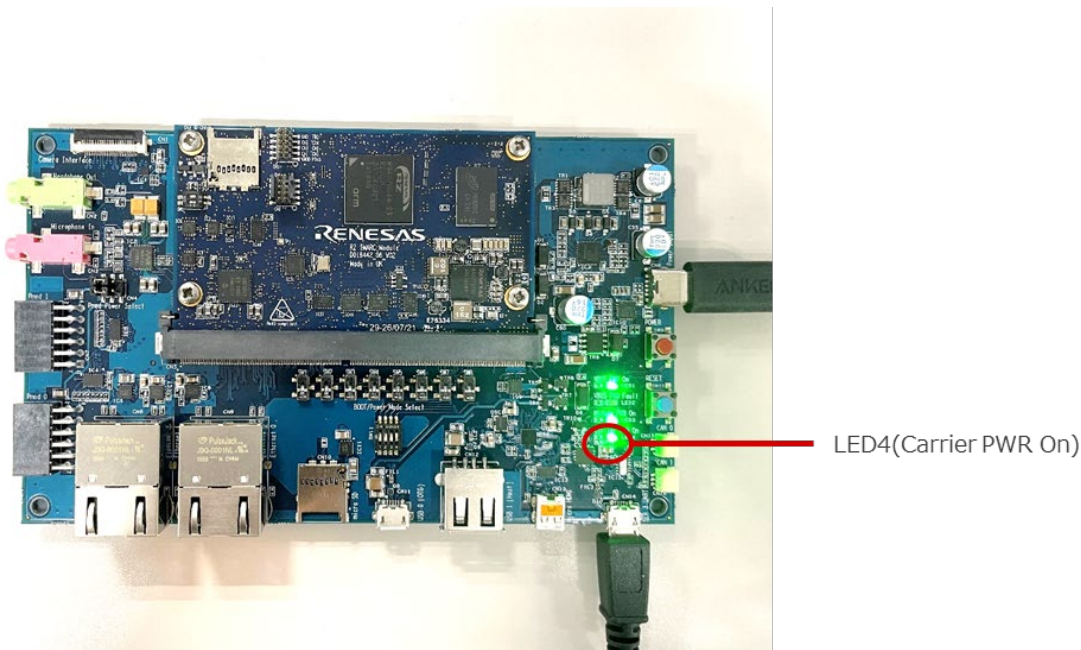

2.1.2.2. Prepare for Serial Communication

- Bring up the terminal software on your PC. Please obtain the latest version of Tera Term from [Releases TeraTermProject/teraterm \(github.com\)](https://releases.teratermproject.com/).
- Select "Serial" as shown in the following figure. "Port:" is "COM[number]: **USB Serial Port** (COM[number])".

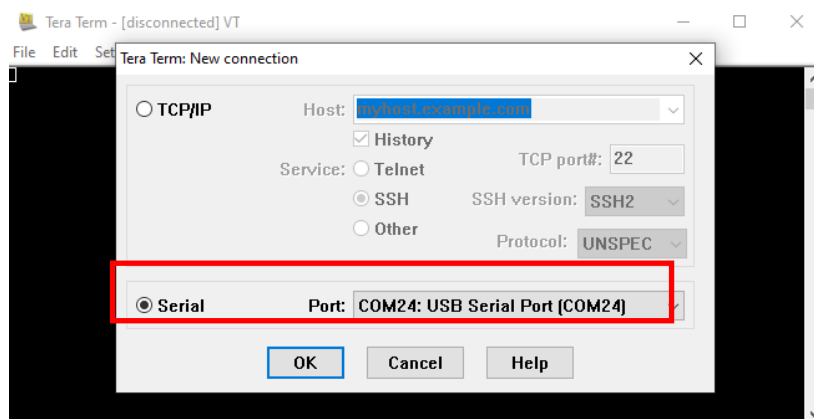

3. Select “Setup” > “Serial port” to set the settings about serial communication protocol on the software. Set each setting as follows:
 - Baud rate: 115200
 - Data: 8 bit
 - Parity: none
 - Stop: 1 bit
 - Flow control: none

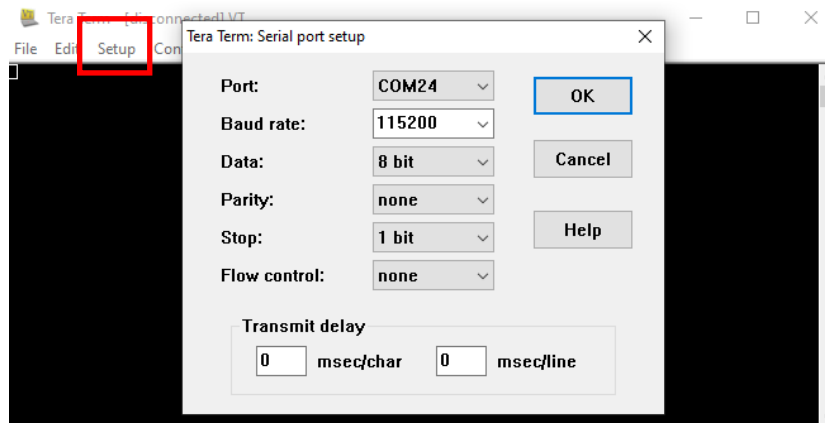

4. After selecting the serial port setup, press the blue button (RESET). Check that the message below is displayed on the console.

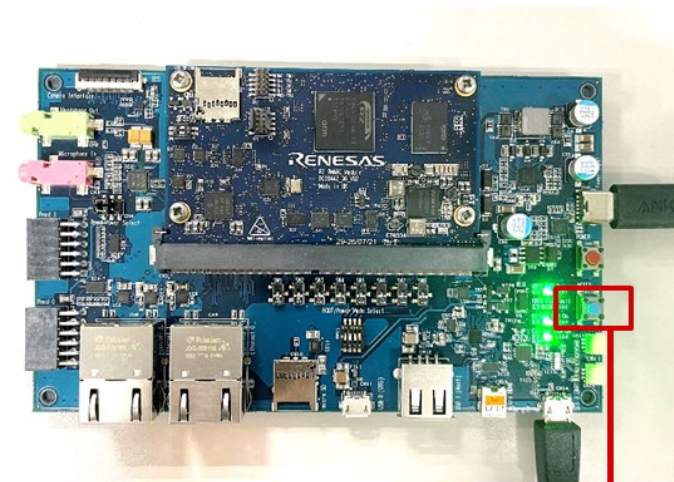

Switch (SW10) : Reset button



2.1.2.3. Send the Flash Writer

- 1. Send an image of the Flash Writer using terminal software after the message “please send !” is shown. Select the “File” > “Send file” menu.

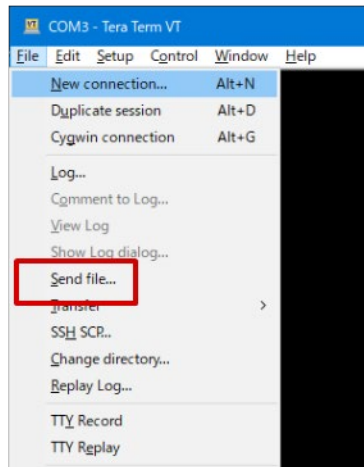
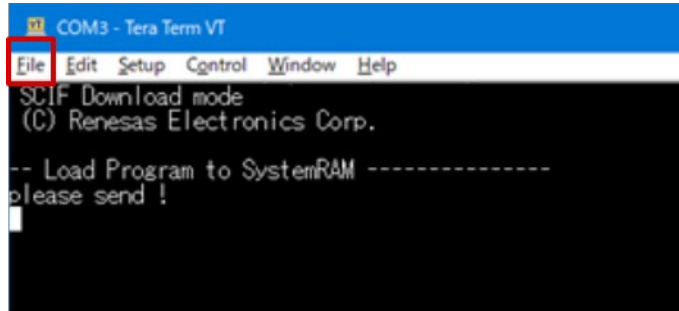

- 2. Select “Flash_Writer_SCIF_RZG2L_SMARC_PMIC_DDR4_2GB_1PCS.mot” and then click “Open” button. The image will be sent to the board via the serial connection.

After successfully downloading the binary, Flash Writer starts automatically and shows a message like the following one on the terminal.

(a) During download

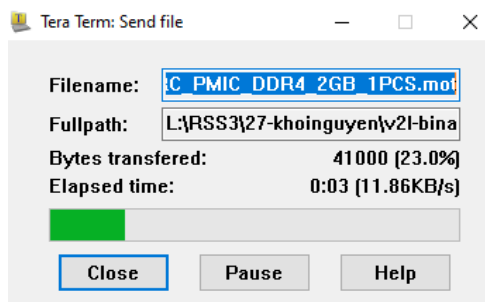

(b) After a successful download

```
Flash writer for RZ/G2 Series V1.06 Aug.10,2022
Product Code : RZ/G2L
>
```

2.1.2.4. Write the Bootloader

1. Before writing the loader files, change the Flash Writer transfer rate from default (115200bps) to high speed (921600bps) with the “SUP” command of the Flash Writer.

```
>SUP
Scif speed UP
Please change to 921.6Kbps baud rate setting of the terminal.
```

After the “SUP” command, change the serial communication protocol speed from 115200bps to 921600bps as well by following the steps described in 2.1.2.2 step3, and then push the enter key.

2. Next, two boot loader files must be written to the target board.

Enter the following bolded commands. Send “bl2_bp-smarc-rzg2l_pmic.srec” by the terminal software in the same manner as in section 2.1.2.3 after the message “please send !” is shown.

```
>XLS2
===== Qspi writing of RZ/G2 Board Command =====
Load Program to Spiflash
Writes to any of SPI address.
Micron : MT25QU512
Program Top Address & Qspi Save Address
===== Please Input Program Top Address =====
Please Input : H'11E00
===== Please Input Qspi Save Address ===
Please Input : H'00000
Work RAM(H'50000000-H'53FFFFFF) Clear....
please send ! ( '.' & CR stop load)
```

If you get the following message, press “y”.

```
SPI Data Clear(H'FF) Check : H'00000000-0000FFFF,Clear OK?(y/n)
```

After successfully writing the binary, a message similar to the following should be shown on the console (the address may be different depending on the version of the boot loader used).

```
SPI Data Clear(H'FF) Check :H'00000000-0000FFFF Erasing..Erase Completed
SAVE SPI-FLASH.....
===== Qspi Save Information =====
SpiFlashMemory Stat Address : H'00000000
SpiFlashMemory End Address : H'0000CB28
=====
```

3. Write another loader file by using bolded commands again.

Send "fip-smarc-rzg2l_pmic.srec" using the terminal software in the same manner as in section 2.1.2.3 after the message "please send !" is shown.

```
>XLS2
===== Qspi writing of RZ/G2 Board Command =====
Load Program to Spiflash
Writes to any of SPI address.
Micron : MT25QU512
Program Top Address & Qspi Save Address
===== Please Input Program Top Address =====
Please Input : H'00000

===== Please Input Qspi Save Address ===
Please Input : H'1D200
Work RAM(H'50000000-H'53FFFFFF) Clear....
please send ! ( '.' & CR stop load)
```

If you get the following message, press "y".

```
SPI Data Clear(H'FF) Check : H'00000000-0000FFFF,Clear OK?(y/n)
```

After successfully write the binary, a message similar to the following will display on the console (the address may be different depending on the version of the boot loader used).

```
SPI Data Clear(H'FF) Check :H'00000000-0000FFFF Erasing..Erase Completed
SAVE SPI-FLASH.....
===== Qspi Save Information =====
SpiFlashMemory Stat Address : H'0001D200
SpiFlashMemory End Address : H'000D353F
=====
```

4. After successfully writing the two loader files, change the serial communication protocol speed from 921600 bps to 115200 bps by following the steps described in section 2.1.2.2 step3, and then push the enter key again.
5. Turn off the board's power by pressing the SW9.

2.1.3. Start Up Linux on the EVK

1. Set the board to SPI Boot mode to start the Bootloader. Change the SW11 as below (SW11-2 ON → OFF). Insert your microSD card to the slot (CN10) on the carry board.

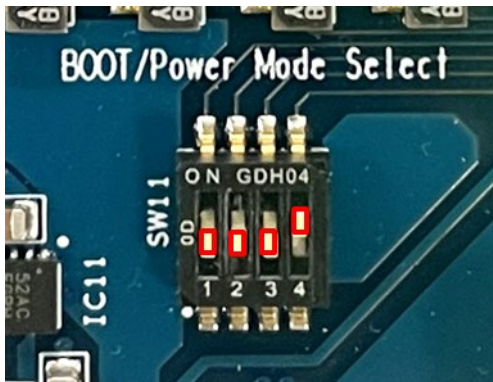

SW11

1	2	3	4
OFF	OFF	OFF	ON

microSD Card slot

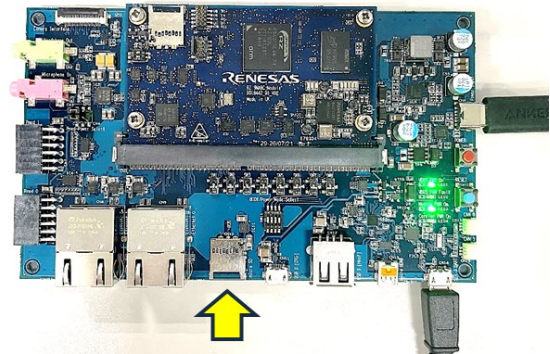

2. Turn on the board’s power by pressing the power red button SW9. The settings of Terminal in this process are the same as in section 2.2.2.

Press the blue button SW10 to reset and after “Hit any key to stop autoboot:” appears, press the enter key on the PC within 3 seconds.

```
U-Boot 2021.10 (Mar 31 2022 - 03:57:20 +0000)
CPU: Renesas Electronics K rev 14.15
Model: smarc-rzg2l
DRAM: 1.9 GiB
MMC: sd@11c00000: 0, sd@11c10000: 1
Loading Environment from MMC... OK
In: serial@1004b800
Out: serial@1004b800
Err: serial@1004b800
Net: eth0: ethernet@11c20000
Hit any key to stop autoboot: 0
=>
```

To set the environment variables, enter the bolded commands below.

```
=> env default -a
## Resetting to default environment
=> saveenv
Saving Environment to MMC... Writing to MMC(0)...OK
```

- Turn the power off and on by pressing red button SW9 again to boot up the board. When “smarc-rz/g2l login:” is displayed, enter “root” to login. (A password is not required.)

```
Version: 3.0.6
smarc-rz/g2l login: root
Last login: Sun Sep 20 10:44:03 UTC 2020
root@smarc-rz/g2l:~#
```

2.1.4. Start Up EVK

By this procedure, display the Capture image of the USB Camera on the HDMI Display.

- Connect the USB Camera, EVK, HDMI Display, and your PC as below.

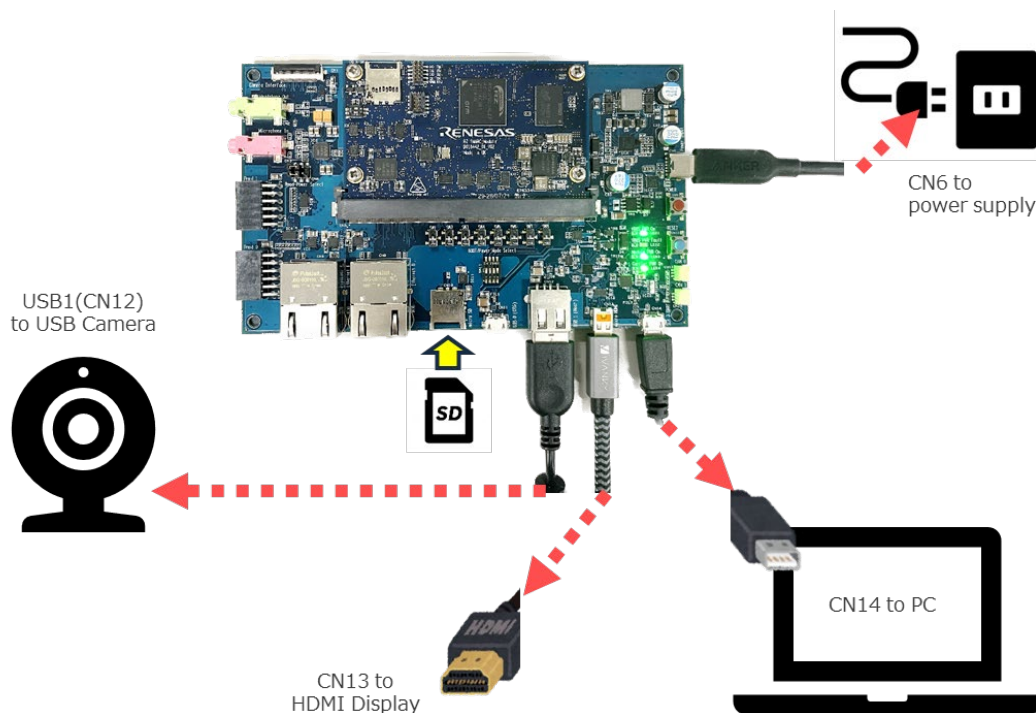

- After EVK booting up, by the following command, the USB Camera Capture image which size of 1920×1080 will be displayed on the HDMI display.

The size can be changed with the options "width" and "height".

```
# gst-launch-1.0 v4l2src ! video/x-raw,format=YUY2,width=1920,height=1080 !
waylandsink
```

- Also, you can confirm the image size supported by your USB camera by using the following command.

```
# v4l2-ctl --list-formats-ext
```

- In case you finish displaying the Capture image, push "Ctrl" key and "c" on the Tera term.

The console changes to the command input screen. To power down the system, enter the command as below.

```
# shutdown -h now
```

- Then, press the SW9 to turn off the power.

2.2 Build the Linux Environment

Section 2.1 describes how to start up the RZ/G2L by using the RZ/G2L VLP pre-built image. If you would like to configure your Linux environment from the VLP build stage, please download the file ([RZ/G Verified Linux Package \(RTK0EF0045Z0021AZJ-v3.0.6.zip\)](#)), and build it by following the [Linux Start-up Guide for RZ/G2L Verified Linux Package v3.0.6](#).

3. Revision History

Revision	Date	Description
1.00	Mar 28, 2024	Initial release.
1.01	Apr 24, 2024	Update for RZ/G VLP v3.0.6
1.02	May 15, 2024	Update the description in 2.1.1 and 2.1.2.4.