

52-PIN PLASTIC QFP (STRAIGHT) (14x14)

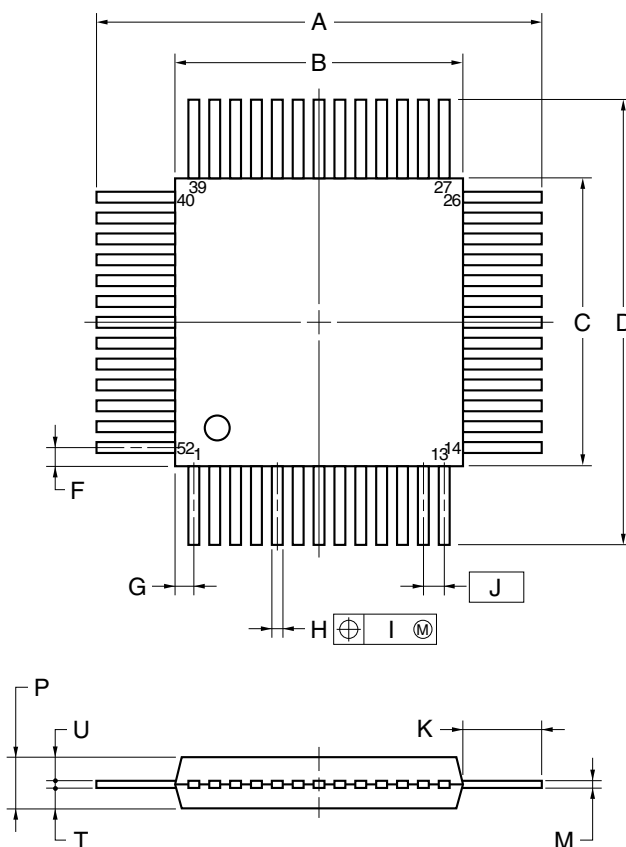

NOTE

Each lead centerline is located within 0.20 mm of its true position (T.P.) at maximum material condition.

ITEM	MILLIMETERS
A	22.0±0.4
B	14.0±0.2
C	14.0±0.2
D	22.0±0.4
F	1.0
G	1.0
H	0.40±0.10
I	0.20
J	1.0 (T.P.)
K	4.0±0.2
M	0.15 ^{+0.10} _{0.05}
P	2.6 ^{+0.2} _{0.1}
T	1.0
U	1.45

P52G-100-01-3