

DATE		REVISIONS		AUTHOR
CREATED	REV	DESCRIPTION		
03/27/13	00	INITIAL RELEASE		MR
12/9/16	01	CHANGE BACK SIDE TAPE 0.022 to 0.025		JH
NOTE:		REFER TO DCP FOR OFFICIAL RELEASE DATE		

NOTES:

1. ALL DIMENSIONS AND TOLERANCES ARE PER ASME Y14.5M-1994.
 2. ALL DIMENSIONS ARE IN MILLIMETERS.
- ⚠ SEATING PLANE AND PRIMARY DATUM -C- ARE DEFINED BY THE CONTACT POINTS OF THREE OR MORE SOLDER BALLS THAT SUPPORT THE DEVICE WHEN PLACED ON A TOP OF A PLANAR SURFACE.
- ⚠ BOTTOM PIN#1 INDICATOR OPTIONAL.

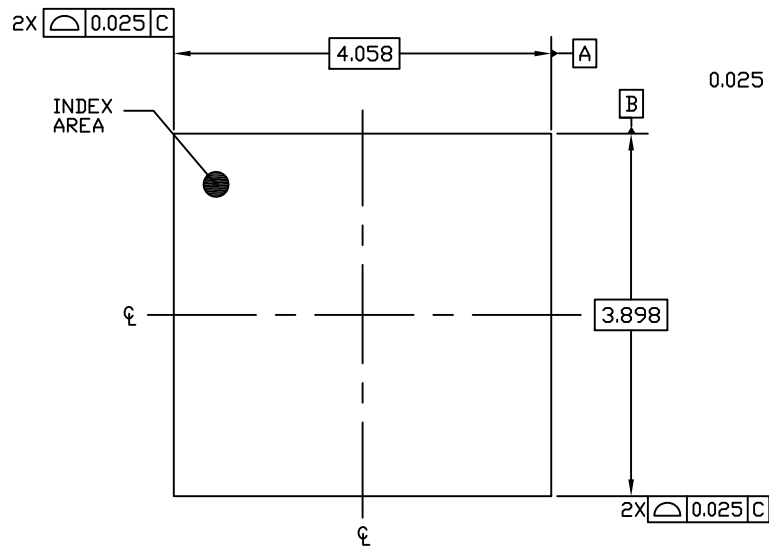

TOP VIEW

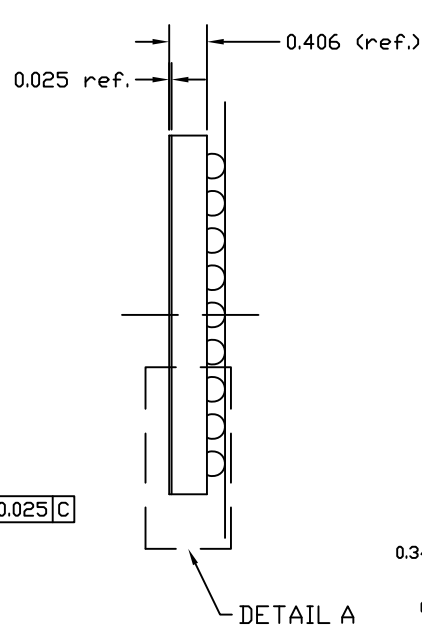

DETAIL A

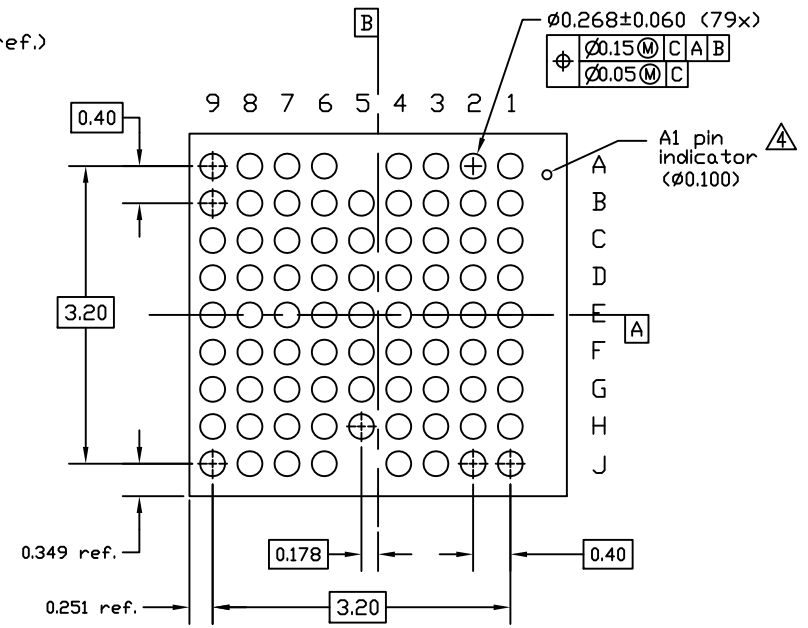

BOTTOM VIEW

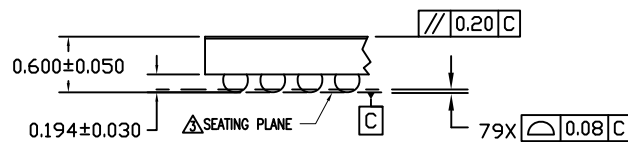

DETAIL A
(ROTATED 90 DEG CW)

TOLERANCES UNLESS SPECIFIED DECIMAL ANGULAR XX± 0.05 ± XXX± 0.012 XXXX±	 www.IDT.com	6024 SILVER CREEK VALLEY ROAD, SAN JOSE, CA 95138 PHONE: (408) 284-8200 FAX: (408) 284-3572	
		TITLE AHG79 PACKAGE OUTLINE 4.058 x 3.898mm BODY 0.4mm PITCH DSBGA	
SIZE C	DRAWING No. PSC-4460	REV 01	
DO NOT SCALE DRAWING		SHEET 1 OF 2	

DATE		REVISIONS	
CREATED	REV	DESCRIPTION	AUTHOR
03/27/13	00	INITIAL RELEASE	MR
12/9/16	01	CHANGE BACK SIDE TAPE 0.022 to 0.025	JH
NOTE: REFER TO DCP FOR OFFICIAL RELEASE DATE			

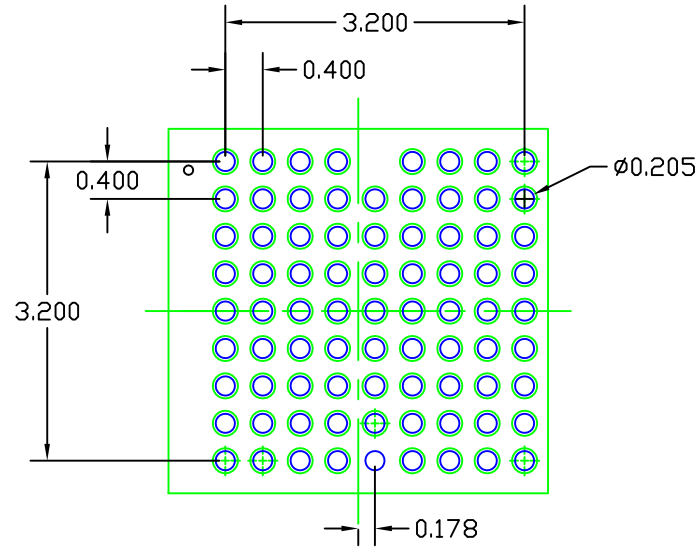

RECOMMENDED LAND PATTERN DIMENSION

NOTES:

1. ALL DIMENSION ARE IN mm, ANGLES IN DEGREES.
2. TOP DOWN VIEW. AS VIEWED ON PCB.
3. COMPONENT OUTLINE SHOW FOR REFERENCE IN GREEN.
4. LAND PATTERN IN BLUE. NSMD PATTERN ASSUMED.
5. LAND PATTERN RECOMMENDATION PER IDT WLCSP APPLICATION NOTE.

TOLERANCES UNLESS SPECIFIED DECIMAL ANGULAR XX± 0.05 ± XXX± 0.012 XXXX±	 IDT™ www.IDT.com		6024 SILVER CREEK VALLEY ROAD, SAN JOSE, CA 95138 PHONE: (408) 284-8200 FAX: (408) 284-3572	
			TITLE AHG79 PACKAGE OUTLINE 4.058 x 3.898mm BODY 0.4mm PITCH DSBGA	
SIZE	DRAWING No.	REV		
C	PSC-4460	01		
DO NOT SCALE DRAWING			SHEET 2 OF 2	