

User's Manual

78K0R/Lx3 - Sense it!

Demonstration Kit

Document No. U20191EE1V0UM00
Date Published November 2009

© NEC Electronics (Europe) GmbH

- **The information in this document is current as of June, 2008. The information is subject to change without notice. For actual design-in, refer to the latest publications of NEC Electronics data sheets or data books, etc., for the most up-to-date specifications of NEC Electronics products. Not all products and/or types are available in every country. Please check with an NEC Electronics sales representative for availability and additional information.**
- No part of this document may be copied or reproduced in any form or by any means without the prior written consent of NEC Electronics. NEC Electronics assumes no responsibility for any errors that may appear in this document.
- NEC Electronics does not assume any liability for infringement of patents, copyrights or other intellectual property rights of third parties by or arising from the use of NEC Electronics products listed in this document or any other liability arising from the use of such products. No license, express, implied or otherwise, is granted under any patents, copyrights or other intellectual property rights of NEC Electronics or others.
- Descriptions of circuits, software and other related information in this document are provided for illustrative purposes in semiconductor product operation and application examples. The incorporation of these circuits, software and information in the design of a customer's equipment shall be done under the full responsibility of the customer. NEC Electronics assumes no responsibility for any losses incurred by customers or third parties arising from the use of these circuits, software and information.
- While NEC Electronics endeavors to enhance the quality, reliability and safety of NEC Electronics products, customers agree and acknowledge that the possibility of defects thereof cannot be eliminated entirely. To minimize risks of damage to property or injury (including death) to persons arising from defects in NEC Electronics products, customers must incorporate sufficient safety measures in their design, such as redundancy, fire-containment and anti-failure features.
- NEC Electronics products are classified into the following three quality grades: "Standard", "Special" and "Specific".
The "Specific" quality grade applies only to NEC Electronics products developed based on a customer-designated "quality assurance program" for a specific application. The recommended applications of an NEC Electronics product depend on its quality grade, as indicated below. Customers must check the quality grade of each NEC Electronics product before using it in a particular application.
"Standard": Computers, office equipment, communications equipment, test and measurement equipment, audio and visual equipment, home electronic appliances, machine tools, personal electronic equipment and industrial robots.
"Special": Transportation equipment (automobiles, trains, ships, etc.), traffic control systems, anti-disaster systems, anti-crime systems, safety equipment and medical equipment (not specifically designed for life support).
"Specific": Aircraft, aerospace equipment, submersible repeaters, nuclear reactor control systems, life support systems and medical equipment for life support, etc.

The quality grade of NEC Electronics products is "Standard" unless otherwise expressly specified in NEC Electronics data sheets or data books, etc. If customers wish to use NEC Electronics products in applications not intended by NEC Electronics, they must contact an NEC Electronics sales representative in advance to determine NEC Electronics' willingness to support a given application.

(Note)

(1) "NEC Electronics" as used in this statement means NEC Electronics Corporation and also includes its majority-owned subsidiaries.

(2) "NEC Electronics products" means any product developed or manufactured by or for NEC Electronics (as defined above).

M8E 02. 11-1

CAUTION

This is a Test- and Measurement equipment with possibility to be significantly altered by user through hardware enhancements/modifications and/or test or application software. Thus, with respect to Council Directive 89/336/EEC (Directive on compliance with the EMC protection requirements), this equipment has no autonomous function. Consequently this equipment is not marked by the CE-symbol.

EEDT-ST-005-10

CAUTION

This equipment should be handled like a CMOS semiconductor device. The user must take all precautions to avoid build-up of static electricity while working with this equipment. All test and measurement tool including the workbench must be grounded. The user/operator must be grounded using the wrist strap. The connectors and/or device pins should not be touched with bare hands.

EEDT-ST-004-10

For customers in the European Union only

Redemption of Waste Electrical and Electronic Equipment (WEEE) in accordance with legal regulations applicable in the European Union only: This equipment (including all accessories) is not intended for household use. After use the equipment cannot be disposed of as household waste. NEC Electronics (Europe) GmbH offers to take back the equipment. All you need to do is register at <http://www.eu.necel.com/weee>

Regional Information

Some information contained in this document may vary from country to country. Before using any NEC product in your application, please contact the NEC office in your country to obtain a list of authorized representatives and distributors. They will verify:

- Device availability
- Ordering information
- Product release schedule
- Availability of related technical literature
- Development environment specifications (for example, specifications for third-party tools and components, host computers, power plugs, AC supply voltages, and so forth)
- Network requirements

In addition, trademarks, registered trademarks, export restrictions, and other legal issues may also vary from country to country.

NEC Electronics Inc. (U.S.)

Santa Clara, California
Tel: 408-588-6000
800-366-9782
Fax: 408-588-6130
800-729-9288

NEC Electronics Hong Kong Ltd.

Hong Kong
Tel: 2886-9318
Fax: 2886-9022/9044

NEC Electronics (Europe) GmbH

Duesseldorf, Germany
Tel: 0211-65 03 0
Fax: 0211-65 03 1327

NEC Electronics Hong Kong Ltd.

Seoul Branch
Seoul, Korea
Tel: 02-528-0303
Fax: 02-528-4411

Sucursal en España

Madrid, Spain
Tel: 091- 504 27 87
Fax: 091- 504 28 60

NEC Electronics Singapore Pte. Ltd.

Singapore
Tel: 65-6253-8311
Fax: 65-6250-3583

Succursale Française

Vélizy-Villacoublay, France
Tel: 01-30-67 58 00
Fax: 01-30-67 58 99

NEC Electronics Taiwan Ltd.

Taipei, Taiwan
Tel: 02-2719-2377
Fax: 02-2719-5951

Filiale Italiana

Milano, Italy
Tel: 02-66 75 41
Fax: 02-66 75 42 99

NEC do Brasil S.A.

Electron Devices Division
Guarulhos, Brasil
Tel: 55-11-6465-6810
Fax: 55-11-6465-6829

Branch The Netherlands

Eindhoven, The Netherlands
Tel: 040-244 58 45
Fax: 040-244 45 80

Branch Sweden

Taeby, Sweden
Tel: 08-63 80 820
Fax: 08-63 80 388

United Kingdom Branch

Milton Keynes, UK
Tel: 01908-691-133
Fax: 01908-670-290

Revision History

Date	Revision	Chapter	Description
2009-12-12	V1.00	---	First release

Table of Contents

1. Introduction	11
1.1 Package contents	11
1.2 Features	11
1.3 System requirements	11
1.4 Trademarks	12
2. 78K0R/Lx3 – Sense It! Components	13
2.1 Operation mode settings	13
2.2 Switch settings	13
2.2.1 SW1	14
2.2.2 SW2	14
2.2.3 SW3	14
2.2.4 SW4 (Cursor)	14
2.2.5 SW5	14
2.3 Jumper settings	15
2.3.1 JP1	15
2.3.2 JP2	15
2.3.3 JP3	15
2.3.4 JP4	15
2.3.5 JP5	15
2.3.6 JP6	15
2.4 Connector	15
2.4.1 FP1	15
2.5 Clock	15
2.5.1 Y1	15
2.5.2 Y2	15
2.6 Other Functions	16
2.6.1 VR1	16
2.6.2 J1	16
2.6.3 J2, J3	16
2.6.4 J4	16
2.6.5 J5	16
2.6.6 LED1	16
2.6.7 LED2	16
2.6.8 BUZ1	16
2.6.9 Universal area	16
2.7 LCD Panel	16
2.8 LCD Drive Voltage	18
2.8.1 Booster Type, Capacitor Split	18
2.8.2 External Resistor Split—1/2 Bias Method (2 / 3 Time-Sharing)	18
2.8.3 External Resistor Split—1/3 Bias Method (3, 4 Time-Sharing)	19
2.8.4 External Resistor Split—1/4 Bias Method (8 Time-Sharing)	20
2.9 Solder-Short Pads	20
2.10 External Power Supply	21
3. 78K0R/Lx3 – Sense It! system configuration	22
3.1 78K0R/Lx3 – Sense it!	22
3.2 Host computer	22
3.3 Power supply via USB interface	22

4.	78K0R/Lx3 – Sense It! installation and operation	23
4.1	Getting started.....	23
4.2	CD-ROM contents	23
5.	Hardware installation	24
6.	Software installation	25
6.1	IAR Systems Embedded Workbench for 78K installation	25
6.2	IAR Sample project	26
6.3	Voice Data Conversion Tool installation	26
6.4	WriteEZ5 installation.....	27
6.5	USB Driver Installation	27
6.5.1	Installation on Windows 2000	27
6.5.2	Installation on Windows XP.....	31
6.6	Confirmation of USB Driver Installation	33
7.	Flash Programmer WriteEZ5	35
7.1	Device Setup.....	35
7.2	Using WriteEZ5.....	36
8.	Voice Data Conversion Tool CvADPCM	38
9.	78K0R/Lx3 – Sense it! Sample Project	39
9.1	Application Overview Flowchart diagram	39
9.2	Initialization message	40
9.3	Clock mode	40
9.4	Kitchen timer mode.....	40
9.5	Voltmeter mode	40
9.6	Sensor mode.....	40
9.7	LCD Evaluation mode	40
9.8	Voice reproduction mode.....	40
9.9	Current consumption measurement mode	41
10.	IAR Embedded Workbench debug session	42
10.1	Settin up the Hardware for a debug session.....	42
10.2	Load the IAR Embedded Workbench sample project	42
10.3	Build and Debug.....	43
11.	Cables	45
11.1	USB interface cable (Mini-B type)	45
12.	Bill of materials	46

13. Schematics 48

List of Figures

Figure 1: 78K0R/LH3+LCD board top view	13
Figure 2: LCD Panel Circuit Diagram	17
Figure 3: 78K0R/Lx3- Sense It! system configuration	22
Figure 4: 78K0R/Lx3 – Sense It! CD-ROM contents	23
Figure 5: 78K0R/Lx3 – Sense It! CRROM autorun.exe	25
Figure 6: IAR Systems Installation screen	26
Figure 7: Found New Hardware Wizard (Windows 2000)	27
Figure 8: Search Method (Windows 2000)	28
Figure 9: Driver File Location (Windows 2000)	28
Figure 10: Address Specification 1 (Windows 2000)	29
Figure 11: Address Specification 2 (Windows 2000)	29
Figure 12: Address Specification 3 (Windows 2000)	30
Figure 13: Driver File Search (Windows 2000)	30
Figure 14: USB Driver Installation Completion (Windows 2000)	31
Figure 15: Found New Hardware Wizard 1 (Windows XP)	31
Figure 16: Found New Hardware Wizard 2 (Windows XP)	31
Figure 17: Search Location Specification 1 (Windows XP)	32
Figure 18: Search Location Specification 2 (Windows XP)	32
Figure 19: Windows XP Logo Testing (Windows XP)	33
Figure 20: USB Driver Installation Completion (Windows XP)	33
Figure 21: Windows Device Manager	34
Figure 22: WriteEZ5 Startup	35
Figure 23: WriteEZ5 Device Setup Dialogue	36
Figure 24: WriteEZ5 Device Menu	36
Figure 25: Voice Data Conversion Tool CvADPCM	38
Figure 26: IAR Embedded Workbench Startup screen	42
Figure 27: IAR Embedded Workbench IDE view	43
Figure 28: IAR Embedded Workbench Debugger Settings	43
Figure 29: IAR C-SPY debugger window	44
Figure 30: USB interface cable (Mini-B type)	45

List of Tables

Table 1: 78K0R/Lx3 – Sense It! Switch and Jumper settings 13
Table 2: SW1 modes 14
Table 3: SW2 modes 14
Table 4: SW3 modes 14
Table 5: SW4 modes 14
Table 6: JP1 settings 15
Table 7: Switch settings Booster Type mode 18
Table 8: Switch settings External Resistor Split mode 1/2 BIAS 18
Table 9: Switch settings External Resistor Split mode 1/3 BIAS 19
Table 10: Switch settings External Resistor Split mode 1/4 BIAS 20
Table 11: TK78K0R/LH3+LCD Solder Short Pads 21
Table 12: WriteEZ4 action buttons 37

1. Introduction

The *78K0R/Lx3 Sense it!* is an evaluation kit for development with sound systems using an 78K0R/LH3, NEC Electronics 16bit all flash microcontroller.

The TK-78K0R/LH3+LCD board that is included in the *78K0R/Lx3 Sense it!* demonstration kit, is pre-programmed with an sample application, which makes usage of the on board peripherals, like a LC display, temperature sensor or an audio plug.

The demonstration kit also includes the CvADPCM Voice Data Conversion PC software which creates c files, which can then be played on the TK-78K0R/LH3+LCD board using the ADPCM software library which is also part of the kit.

1.1 Package contents

- TK-78K0R/LH3+LCD board
- USB cable
- CD-ROM containing the CvADPCM Voice Data Conversion tool, WriteEZ5 and an evaluation copy of the IAR Embedded Workbench for 78K with 16Kbyte code size limitation.

Please verify that you have received all parts listed in the package contents list attached to the *78K0R/Lx3 - Sense it!* demonstration kit package. If any part is missing or seems to be damaged, please contact the dealer from whom you received your *78K0R/Lx3 - Sense it!*.

1.2 Features

- NEC Electronics all flash 16-bit 78K0R/LH3 MCU μ PD78F1508
- NEC Electronics μ PD78F0730 MCU with on-chip USB interface
- 50 x 8 LCD display
- Temperature sensor
- Audio Plug
- Voice data conversion tool (.wav \rightarrow .c file) for ADPCM 78K0R audio library
- The IAR Embedded Workbench for 78K and the IAR C-SPY debugger / simulator are included. These packages are restricted in such that maximum program code size is limited to 16 Kbyte.
- Full documentation is included for the NEC 78K078F1508 microcontroller, NEC 78K0 78F0730 microcontroller, IAR Systems Embedded Workbench and IAR Systems C-SPY debugger / simulator.

The *78K0R/Lx3 – Sense it!* is not intended for code development. NEC does not allow and does not support in any way any attempt to use *78K0R/Lx3 – Sense It!* in a commercial or technical product.

1.3 System requirements

HOST PC A PC supporting Windows 2000, Windows XP or Windows Vista is required for the IAR Systems Embedded Workbench demo-version.
A Pentium processor with at least 1 GHz CPU performance, with at least 256 Mbytes of RAM, allowing you to fully utilize and take advantage of the product features. 500 Mbytes of free disk space and an additional 10 Mbytes of free disk space on the Windows system drive.

Host interface A web browser and Adobe Acrobat Reader to be able to access all the product documentation.
USB interface that enables communication based on USB (Ver1.1 or later)

Note: Updates of the IAR Embedded Workbench for 78K, documentation and/or utilities for *78K0RLX3-SENSEIT*, if available, may be downloaded from the NEC WEB page(s) at <http://www.eu.necel.com/78K0RLX3-SENSEIT>

1.4 Trademarks

IAR Embedded Workbench and C-SPY are registered trademarks of IAR Systems AB. Microsoft and Windows are registered trademarks of Microsoft Corporation. Adobe and Acrobat Reader are registered trademarks of Adobe Systems Incorporated.

All other product names are trademarks or registered trademarks of their respective owners.

2. 78K0R/Lx3 – Sense It! Components

The TK-78K0R/LH3+LCD board is equipped with USB-connector and with several connectors in order to be connected to host computers, FLASH programmer, MiniCube2 or any external target hardware.

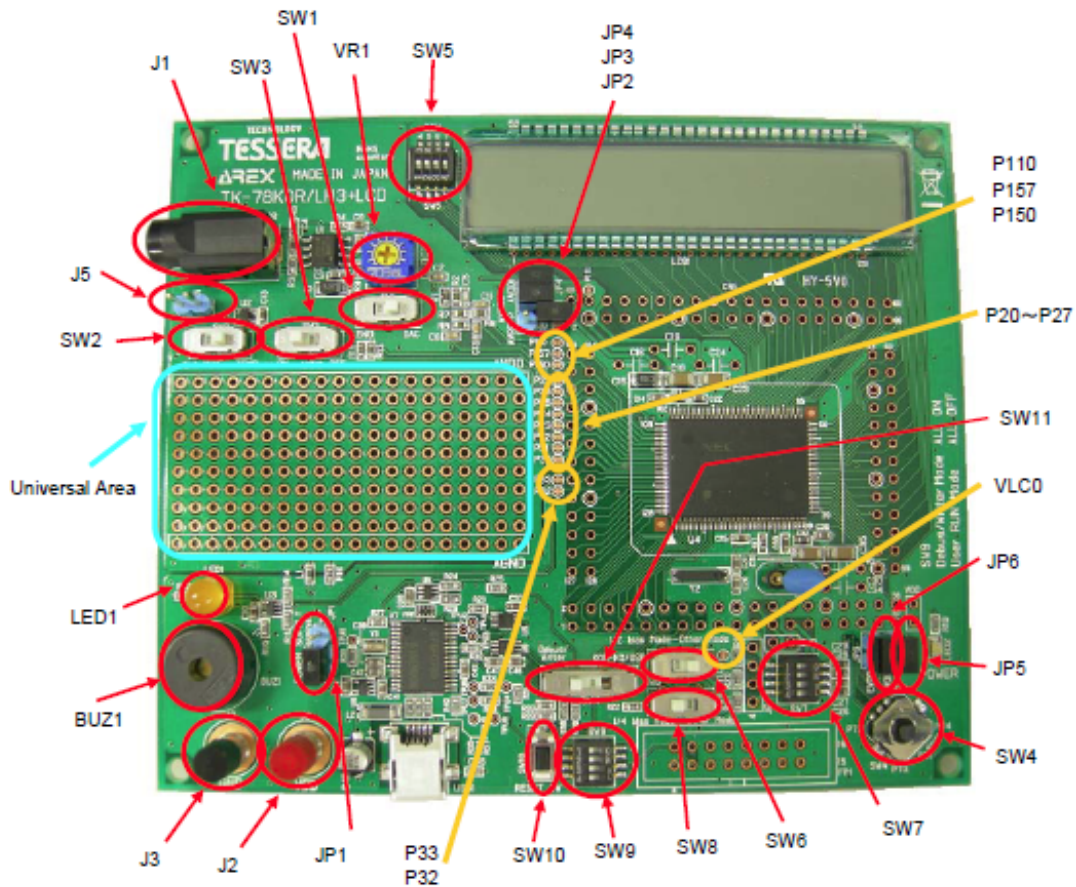

Figure 1: 78K0R/LH3+LCD board top view

2.1 Operation mode settings

The 78K0R/Lx3 – Sense It! supports different operation modes that have to be selected by switches and jumpers are available on the board.

Switch	Debugging/Writing Mode	PC Communication Mode
SW11	"Debug/Writer"	"K0R-K0/USB"
SW9	All ON	All OFF

Table 1: 78K0R/Lx3 – Sense It! Switch and Jumper settings

- Debugging/Writing Mode Set Debugging Mode when you use ID78K0R-QB-EZ. Set Writing Mode when you use WriteEZ5.
- PC Communication Mode Connect UART0 of 78K0R/LH3 and UART6 of K0/USB (uPD78F0730) which is mounted on the board. This enables the communication with PC by Pseudo-connect the UART0 and COM port of PC.

2.2 Switch settings

2.2.1 SW1

SW1 can set the signal that is connected to "- side" of microcontroller built-in operational amplifier 0 (AMP0 - terminal).

SW1	Mode
DAC	Connect D/A converter (ANO0) to "- side" of microcontroller built-in operational amplifier 0 (AMP0 - terminal).
GND	Connect "- side" of microcontroller built-in operational amplifier 0 (AMP0 - terminal) to GND.

Table 2: SW1 modes

2.2.2 SW2

SW2 can set the input voltage for A/D converter (ANI 1).

SW1	Mode
TEMP	Connect the output of temperature sensor to A/D converter (ANI 1 terminal)
Ext Volt	Connect the voltage of J5 connector to A/D converter (ANI 1 terminal)

Table 3: SW2 modes

2.2.3 SW3

SW3 can select if it uses microcontroller built-in operational amplifier 0 or not.

SW3	Op-Amp 0	Remarks
ON	Use	Amplify 10-fold the voltage input to J5 connector by using operational amplifier 0. * Set SW2 to "Ext Volt" side.
OFF	Not Use	Not to use operational amplifier 0

Table 4: SW3 modes

2.2.4 SW4 (Cursor)

SW4 is 4 Ways + Center-push Switch. It becomes "Low" when it is pushed or shifted to the side. It becomes "Open" when it is released. You need to set microcontroller built-in pull-up option resistor (PU7) to "ON". (For details about settings of microcontroller built-in pull-up option resistor, refer to the [User's manual](#) of 78K0R/Lx3).

SW 4	Target Microcontroller Pin Name	Remarks
1pin	P70/KR0	UP
2pin	P71/KR1	CENTER PUSH
3pin	P72/KR2	LEFT
4pin	P74/KR3	RIGHT
5pin	GND	
6pin	P73/KR3	DOWN

Table 5: SW4 modes

2.2.5 SW5

SW5 can select the time-sharing of LCD.

SW5	Time-Sharing
ALL OFF	4, 3, 2, Static
ALL ON	8

2.3 Jumper settings

2.3.1 JP1

JP1 is a switch jumper to select the power supply.

Position	Function
1-2	USB power supply connected (USB1)
2-3	Power supply via J2 (VDD) or J3 (GND)

Table 6: JP1 settings

2.3.2 JP2

JP2 is the point to measure consumption current of microcontroller AVREFP terminal. Take off short pin and connect an ampere meter to measure the current. As the sample software uses VREFOUT, take off the short pin. It is opened as default.

2.3.3 JP3

JP3 is the point to measure consumption current of microcontroller AVDD0 terminal. Take off short pin and connect an ampere meter to measure the current. It is shorted as default.

2.3.4 JP4

JP4 is the point to measure consumption current of microcontroller AVDD1 terminal. Take off short pin and connect an ampere meter to measure the current. It is shorted as default.

2.3.5 JP5

JP5 is the point to measure consumption current of microcontroller VDD terminal. Take off short pin and connect an ampere meter to measure the current. It is shorted as default.

2.3.6 JP6

JP6 is the point to measure consumption current of microcontroller EVDD terminal. Take off short pin and connect an ampere meter to measure the current. It is shorted as default.

2.4 Connector

2.4.1 FP1

This is the interface to connect MINICUBE2.

The connector itself is not attached. If you wish to connect MINICUBE2, you need to solder the 16pin connector on FP1.

2.5 Clock

2.5.1 Y1

This is the main clock. 20MHz Ceralock (Murata: CSTLS20M0X51-B0) is mounted.

2.5.2 Y2

This is the sub clock. 32.768KHz oscillator (SII: SSP-T7-FL 3.7pF) is mounted.

2.6 Other Functions

2.6.1 VR1

This is the volume control for J1.

2.6.2 J1

J1 is the stereo mini-jack for audio output. Audio is output on left side only.

2.6.3 J2, J3

External power supply connectors. For further information refer to the [“External Power Supply” chapter](#).

2.6.4 J4

This is the pad for a battery socket (on the back side of the board). For further information refer to the [“External Power Supply” chapter](#).

2.6.5 J5

J5 is the terminal to connect voltage to be measured. It can apply a voltage 0V-2.0V without using operational amplifier and 0.02V-0.22V with using operational amplifier.

2.6.6 LED1

LED1 is LED controlled by "P33/INTP3/TI07/TO07". It lights by outputting "Low".

2.6.7 LED2

This is the Power LED. It lights up if power is supplied to the board.

2.6.8 BUZ1

BUZ1 is a piezoelectric buzzer (TDK: PS1240P02BT) controlled by "P32/INTP5/TI01/TO01/PCLBUZ0". It sounds by outputting about 4 KHz pulse.

2.6.9 Universal area

The kit has the universal area. Users can use this to develop custom circuit.

2.7 LCD Panel

The LCD panel has following specifications.

- TN liquid crystal
- 1/8DUTY
- 5V Drive
- 8COM x 50SEG = 400 segment

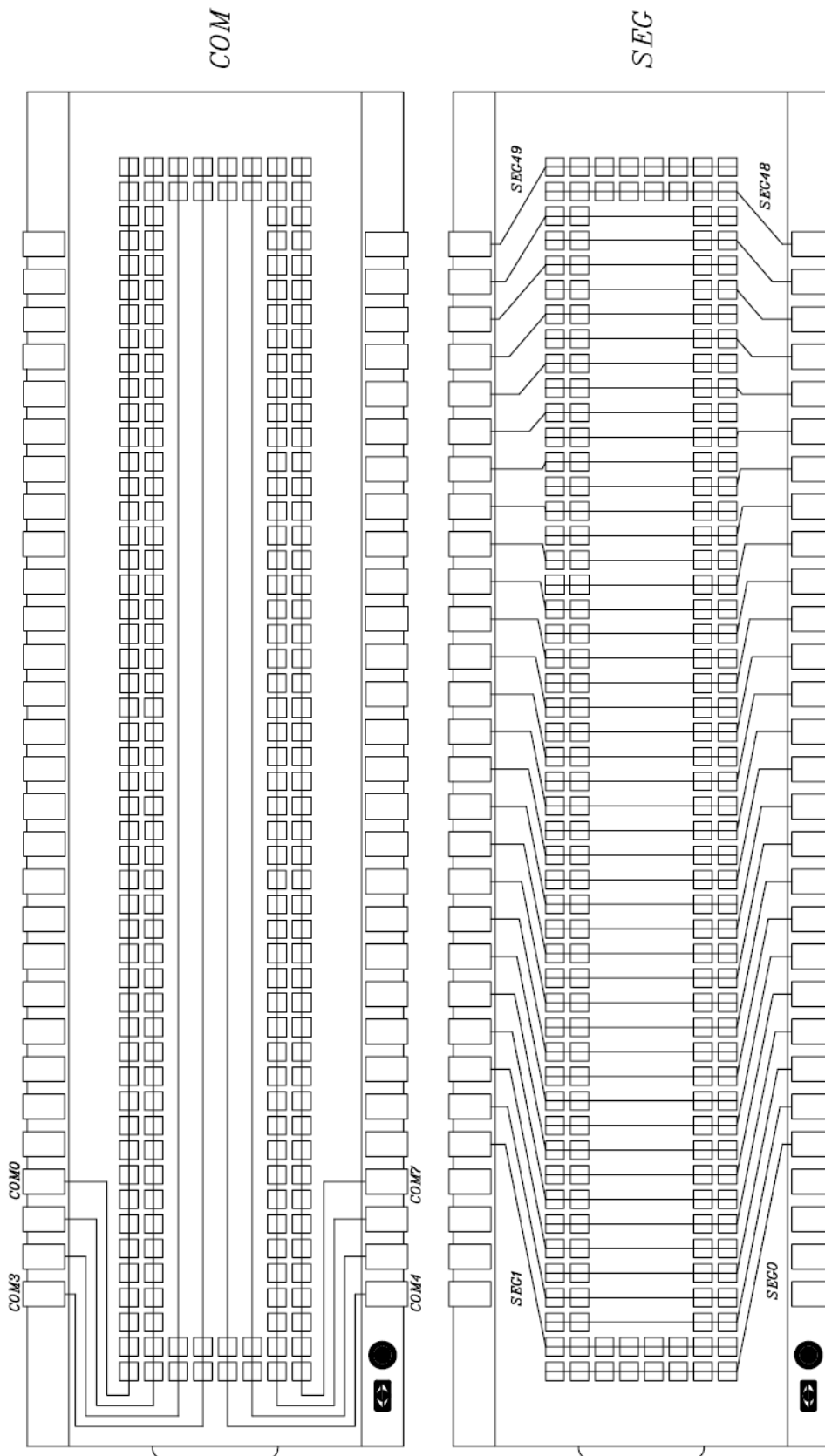

Figure 2: LCD Panel Circuit Diagram

2.8 LCD Drive Voltage

The allowed LCD drive voltages can be selected by switches mounted to the TK-78K0R/LH3+LCD board.

2.8.1 Booster Type, Capacitor Split

Set the switches as shown below.

SW7	All OFF
SW6	Any
SW8	Any

Table 7: Switch settings Booster Type mode

A 0.47μF capacitor is connected to each terminal, following methods can be selected.

- Booster Type – 1/3 bias method
- Booster Type – 1/4 bias method
- Capacitor Split – 1/3 bias method

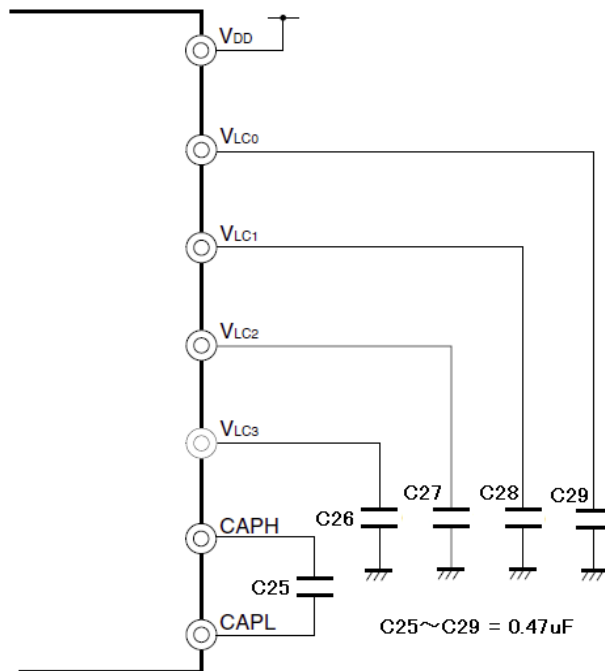

2.8.2 External Resistor Split – 1/2 Bias Method (2 / 3 Time-Sharing)

Set the switches as shown below. It is connected with 100KΩ of resistance (diagram below).

SW7	All ON
SW6	1/2 Bias Mode
SW8	Other Mode

Table 8: Switch settings External Resistor Split mode 1/2 BIAS

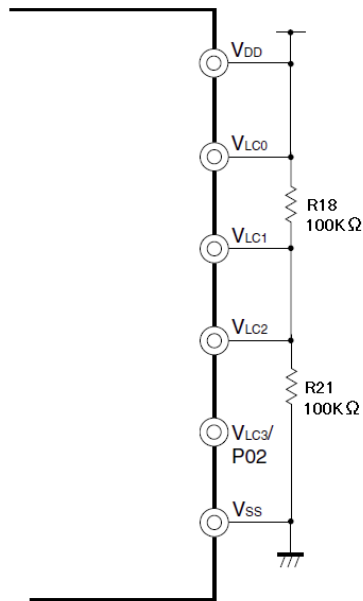

2.8.3 External Resistor Split – 1/3 Bias Method (3, 4 Time-Sharing)

Set the switches as shown below. It is connected with 100KΩ of resistance (diagram below).

SW7	All ON
SW6	Other Mode
SW8	Other Mode

Table 9: Switch settings External Resistor Split mode 1/3 BIAS

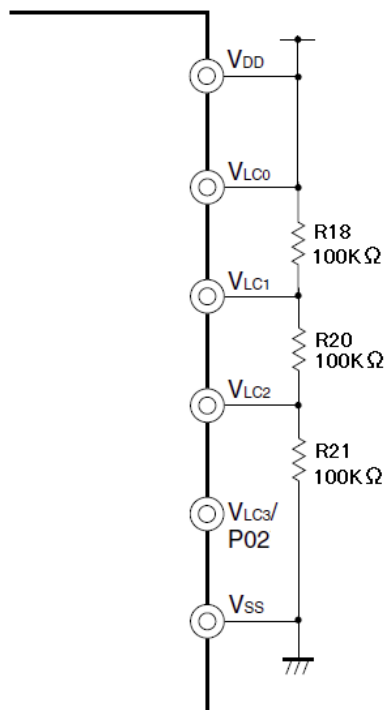

2.8.4 External Resistor Split – 1/4 Bias Method (8 Time-Sharing)

Set the switches as shown below. It is connected with 100KΩ of resistance (diagram below).

SW7	All ON
SW6	Other Mode
SW8	1/4 bias Mode

Table 10: Switch settings External Resistor Split mode 1/4 BIAS

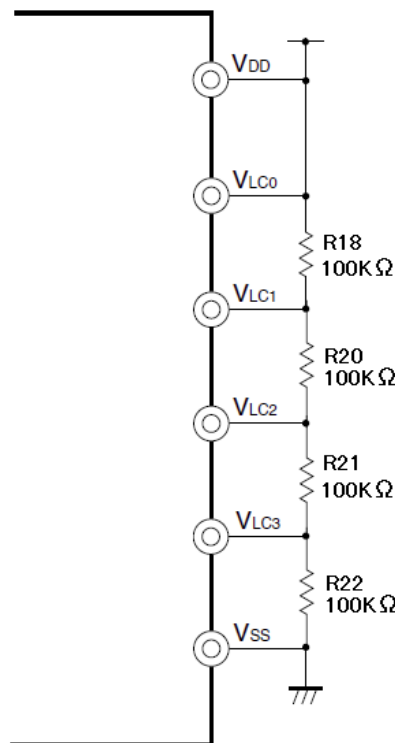

2.9 Solder-Short Pads

With using the solder-short pad to cut/connect the circuit, users can customize the circuit. The solder-short pad looks like the picture below. To open, use cutter to cut the dent part. To short, put solder on the pad.

Solder-short pad (Open)



Solder-short pad (Short)



Solder-Short Pad Name	Default	Connection	
P20~P27	Short	Short	Connect port2 to analog circuit
		Open	Use port2 for other purpose
P32	Short	Short	Connect port32 to the driver of buzzer
		Open	Use port32 for other purpose
P33	Short	Short	Connect port33 to the driver of LED1
		Open	Use port33 for other purpose
P110	Short	Short	Connect port110 to analog circuit

		Open	Use port110 for other purpose
P111	Short	Short	Connect port111 to SW1
		Open	Use port111 for other purpose
P150	Short	Short	Connect port150 to analog circuit
		Open	Use port150 for other purpose
P157	Short	Short	Connect port157 to GND
		Open	Use port157 for other purpose
VLC0	Short	Short	Connect to VDD when SW4-1 is set to "ON"
		Open	Connect VLC0 not to VDD

Table 11: TK78K0R/LH3+LCD Solder Short Pads

2.10 External Power Supply

A Power supply other than USB is available by using the terminal (J2: VDD, J3: GND) or button battery socket (not mounted) on the back side of substrate. Set the JP1 to 2-3 short and connect a stabilized power supply to the terminal pins J2 (VDD) and J3 (GND). Also, you can mount battery socket on J4 to supply power from battery.

Support battery socket: KEYSTONE 1060

Caution: Do not supply power from terminal while using a battery. If the terminal (J2: VDD) and the anode of the battery is connected, the battery will be destroyed.

3. 78K0R/Lx3 – Sense It! system configuration

The 78K0R/Lx3 – Sense It! starter kit system configuration is given in the diagram below

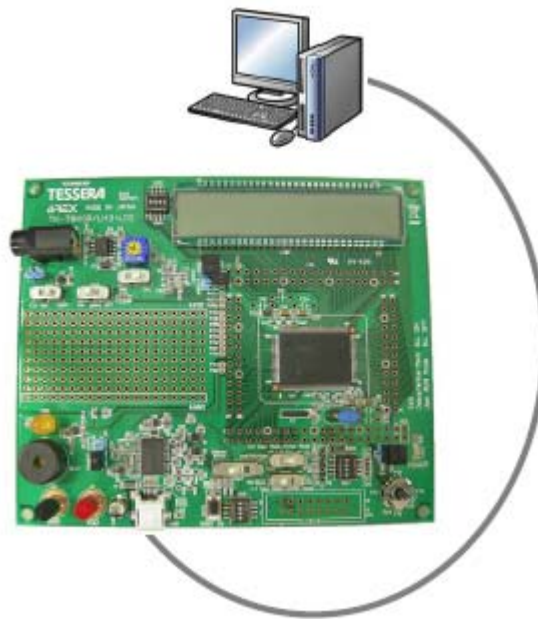

Figure 3: 78K0R/Lx3- Sense It! system configuration

3.1 78K0R/Lx3 – Sense it!

The 78K0R/Lx3 – Sense It! is a demonstration kit for the 78F1508 16-bit microcontroller of the 78K0R family. The demonstration board is connected to the host system via USB interface cable. The host system may be used for On-Chip debugging by using the IAR C-SPY debugger and to allow execution of application programs on 78K0R/Lx3 – Sense It! starter kit.

78K0R/Lx3 – Sense It! runs the microcontroller at 20 MHz operating speed in normal operation mode.

3.2 Host computer

The USB host interface enables communication to the 78K0R/Lx3 – Sense It! board. The μ PD78F0730 78K0 8-Bit microcontroller with on-chip USB interface and the NEC virtual UART driver allows application software to access the μ PD78F1508 device in the same way as it would access a standard RS232 interface. The NEC virtual UART driver appears to the windows system as an extra Com Port, in addition to any existing hardware Com Ports.

3.3 Power supply via USB interface

The TK-78K0R/LH3+LCD board is powered by the USB interface. Optional the power supply can be applied via the connectors J2 (VDD) and J3 (GND) or an external battery mounted to J4 on the back side of the starter kit board.

4. 78K0R/Lx3 – Sense It! installation and operation

4.1 Getting started

The 78K0R/Lx3 – Sense It! is delivered with a pre-programmed sample application, that makes use of the available peripherals of the TK-78K0R/LH3+LCD board. The CD comes with a 16KB code size limited version of the IAR Embedded Workbench and a software tool to generate a .c file out of a .wav audio file. The also include sound library enables the user to program and hear the wanted sound file via a audio output connected to the audio jack mounted on the board.

4.2 CD-ROM contents







NEC 78K0R/Lx3 - Sense It!	CD-ROM ROOT
 Acrobat	- Acrobat Reader for 32Bit Windows OS
 Doc	- Documentation
 Driver	- TK-78K0R/LH3+LCD device driver files
 IAR Embedded Workbench	- IAR Embedded Workbench for 78K
 sample program	- Example project for the 78K0R/Lx3 - Sense It! Demonstration Kit
 WriteEZ5	- Flash Programmer WriteEZ5 incl. PRM file for μ PD78F1508

Figure 4: 78K0R/Lx3 – Sense It! CD-ROM contents

5. Hardware installation

After unpacking the *78K0R/Lx3 – Sense It!* demonstration kit, connect the board via connector USB1 to your host computer using the provided USB interface cable. When TK-78K0R/LH3+LCD board is connected, the USB driver needs to be installed on the host machine. Please refer to the following [USB Driver Installation](#).

6. Software installation

The *78K0R/Lx3 – Sense It!* package comes with the following software packages:

- IAR Systems Embedded Workbench for 78K 16KB code size limited, including C compiler, assembler, linker, librarian and IAR C-SPY debugger / simulator
- Voice Data Conversion Tool CvADPCM
- WriteEZ5 flash programmer software including the PRM file for μ PD78F1508
- IAR Embedded Workbench for 78K sample project

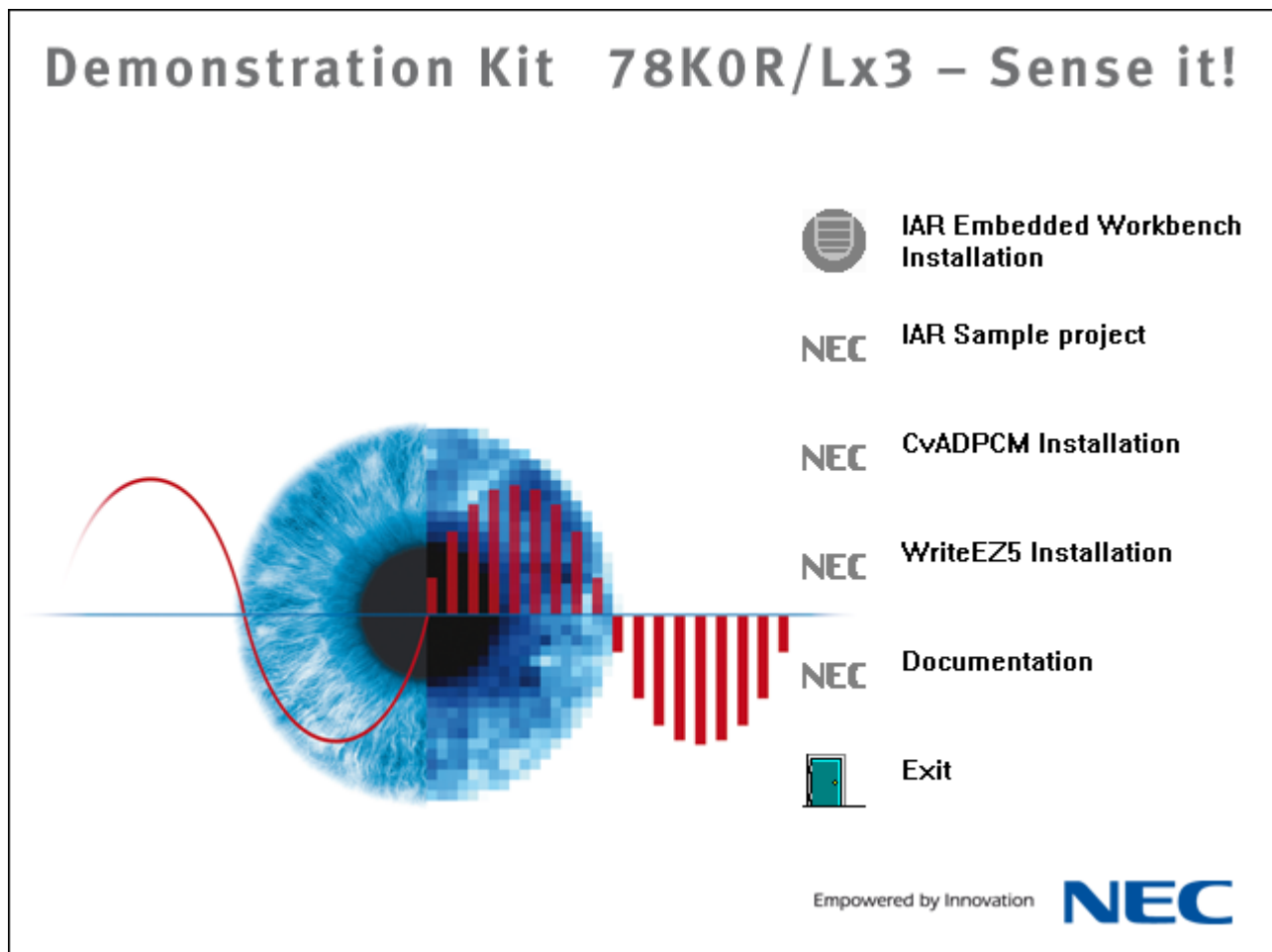

Figure 5: 78K0R/Lx3 – Sense It! CRROM autorun.exe

6.1 IAR Systems Embedded Workbench for 78K installation

To install the IAR Systems Embedded Workbench for 78K including C-SPY debugger / simulator press the regarding button from the Autorun of the CDROM provided within the *78K0R/Lx3 – Sense It!* package. The installation can also be started by executing the `Autorun.exe` program in the directory "`\IAR Embedded Workbench\`" of the CDROM.

When running the `autorun.exe` the following screen appears.

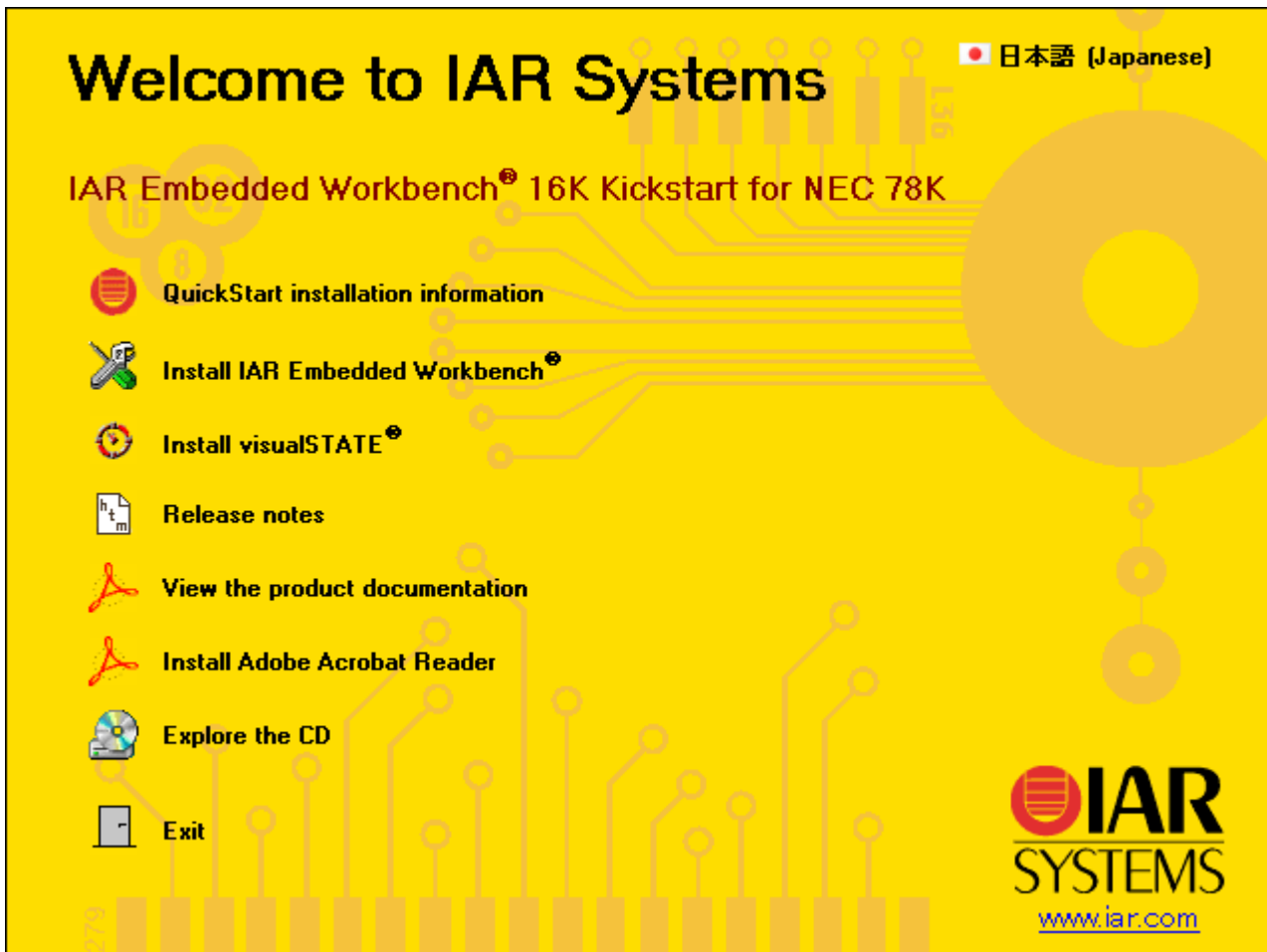

Figure 6: IAR Systems Installation screen

Note: Before installing the IAR Embedded Workbench for 78K 16KB code size limited version a license number and key has to be requested from IAR Systems. Therefore please follow the IAR online registration. The license number and key shall be provide within a view minutes after the request is submitted.

To install the IAR Embedded Workbench for 78K just press the regarding button “Install IAR Embedded Workbench®”. The setup dialogues will guide you through the installation process. For further information about the IAR Embedded Workbench installation refer to the `InstallationGuide_IAR_EWB.ENU.pdf` in the directory “\IAR Systems\” of the CDROM.

6.2 IAR Sample project

To copy the IAR sample project just press the regarding button “IAR sample project”. The setup dialogues will guide you through the copying process. The installation can also be started by executing the `IAR_sample_project.exe` in the directory “\sample program” of the CDROM.

6.3 Voice Data Conversion Tool installation

To install the CaADPCM Voice Data Conversion Tool just press the regarding button from the Autorun of the CD-ROM provided within the *78K0R/Lx3 – Sense It!* package. The setup dialogues will guide you through the installation process. The installation can also be started by executing the `CvADPCM Voice Data Conversion Tool v140.exe` in the directory “\Voice Data Conversion Tool” of the CDROM.

6.4 WriteEZ5 installation

To install the WriteEZ5 just press the regarding button from the Autorun of the CD-ROM provided within the 78K0R/Lx3 – Sense It! package. The setup dialogues will guide you through the installation process. The installation can also be started by executing the WriteEZ5_v100_EE.exe in the directory “\WRITEEZ5” of the CDROM.

6.5 USB Driver Installation

In order to use the TK-78K0RKE3L board, the USB driver needs to be installed on the host machine. Install the driver according to the following procedure:

Installation on Windows 2000	Page 27
Installation on Windows XP	Page 31

6.5.1 Installation on Windows 2000

1. When the TK-78K0R/LH3+LCD board is connected with the host machine, the board is recognized by <Plug and Play>, and the wizard for finding new hardware is started. Click **Next>**.



Figure 7: Found New Hardware Wizard (Windows 2000)

2. Following the window below is displayed. So, check that "Search for a suitable driver ..." is selected, then click **Next>**.

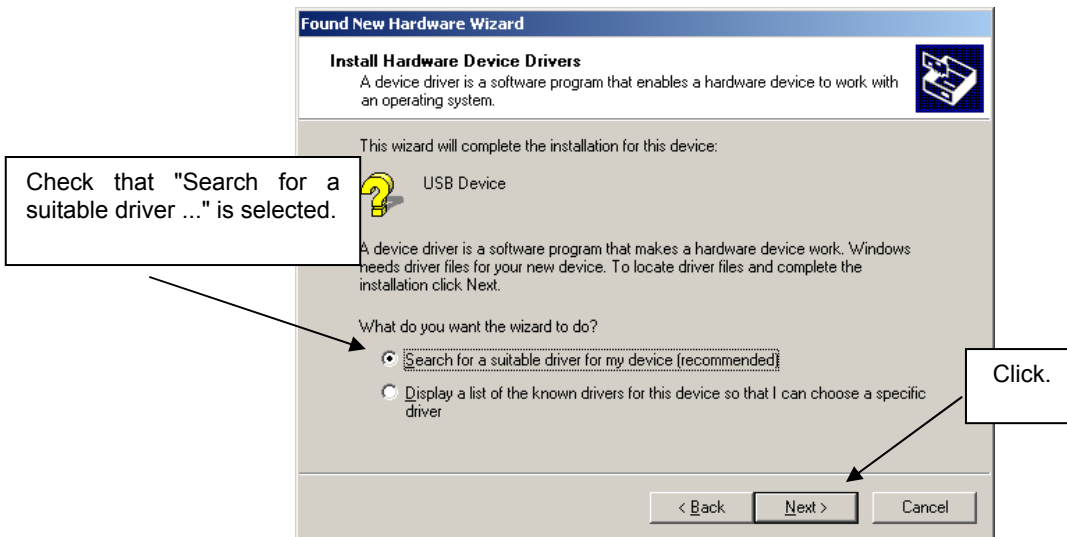

Figure 8: Search Method (Windows 2000)

3. Check the "Specify a location" check box only, then click **Next>**.

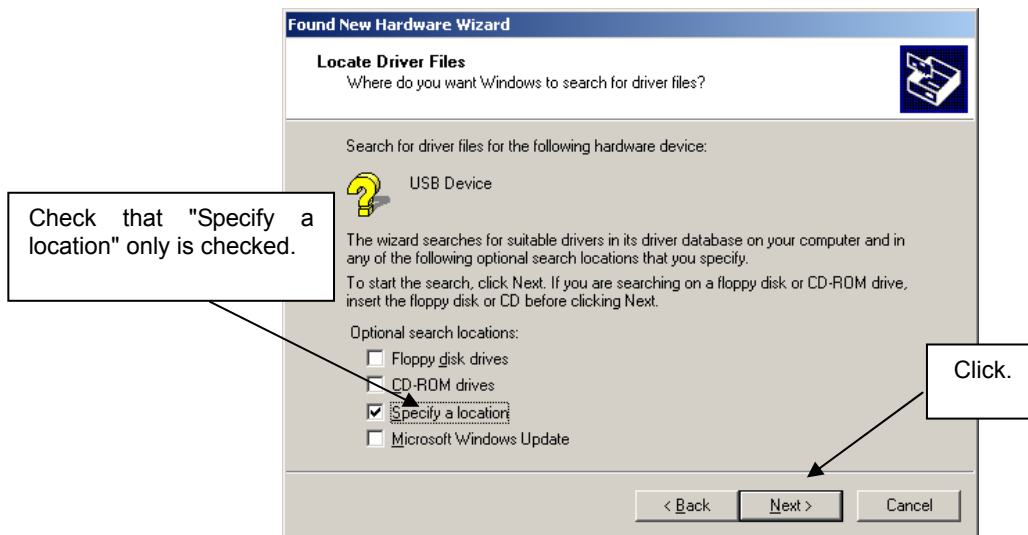

Figure 9: Driver File Location (Windows 2000)

4. Locate to the folder "CDROM:\Driver".

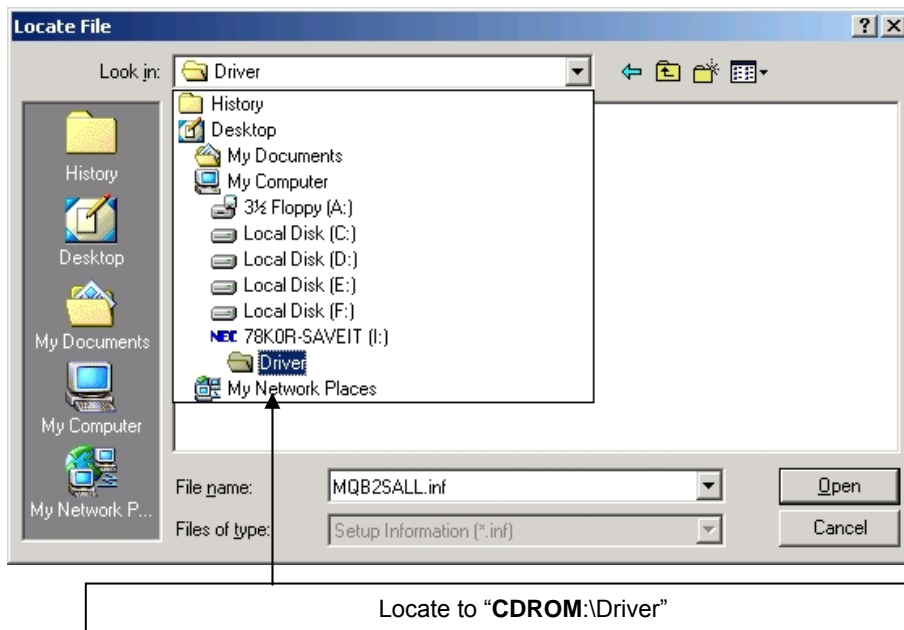

Figure 10: Address Specification 1 (Windows 2000)

5. The setup information file “MQB2ALL.inf” is automatic selected, then click **Open** to proceed within driver installation.

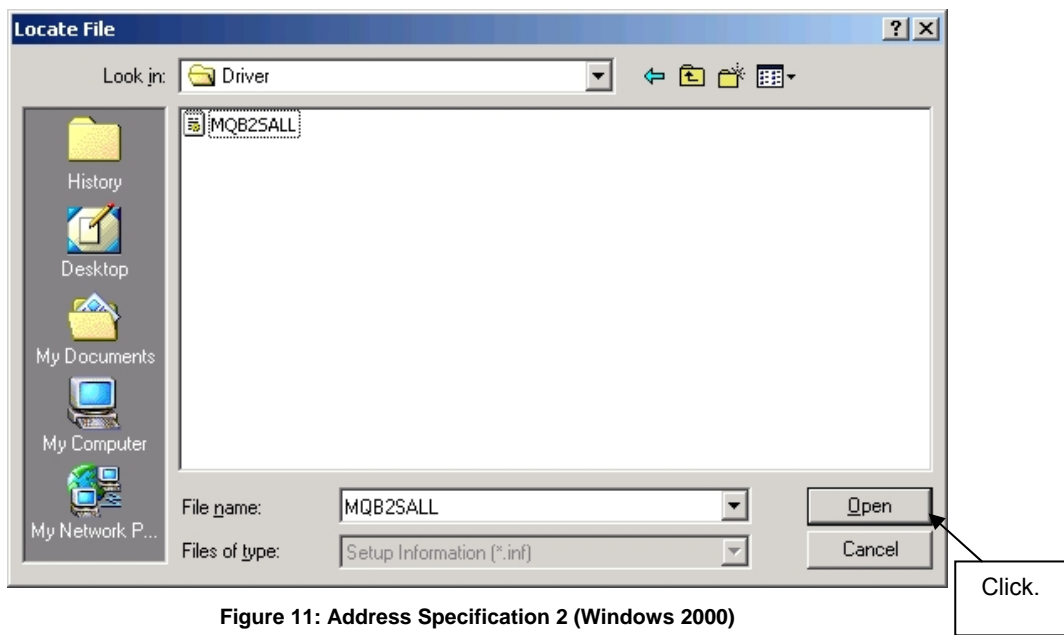

Figure 11: Address Specification 2 (Windows 2000)

6. After the location of the USB driver has been specified click **OK** to proceed.



Figure 12: Address Specification 3 (Windows 2000)

- 7. Click **Next>**.

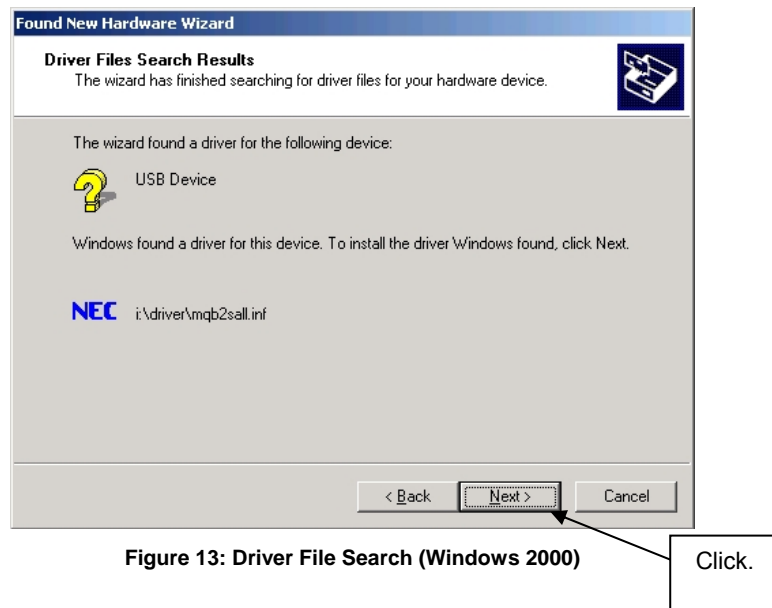

Figure 13: Driver File Search (Windows 2000)

- 8. Click **Finish** to complete the installation of the USB driver.

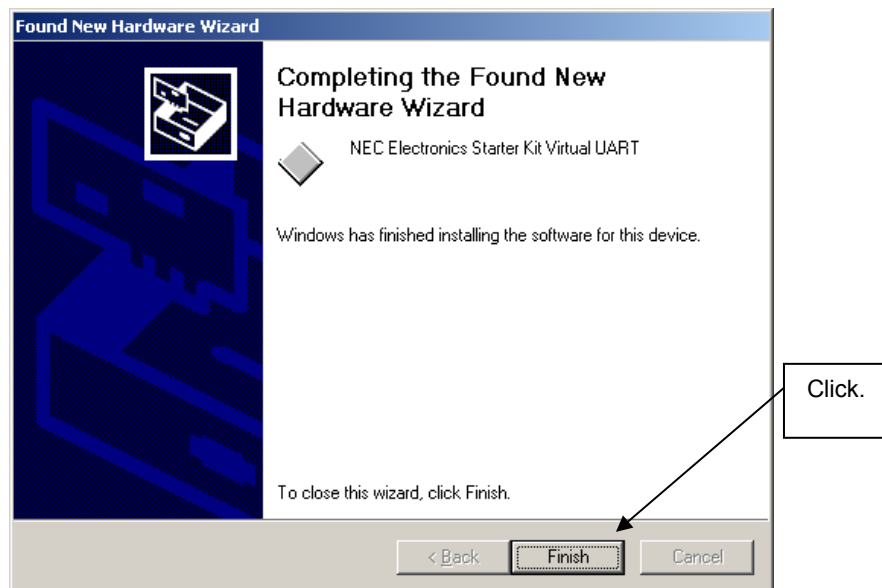

Figure 14: USB Driver Installation Completion (Windows 2000)

6.5.2 Installation on Windows XP

1. When the TK-78K0R/LH3+LCD board is connected with the host machine, the board is recognized by Plug and Play, and the wizard for finding new hardware is started. At first the hardware wizard will ask if windows should search on the windows update web, check "No, not this time" and then click **Next>**.



Figure 15: Found New Hardware Wizard 1 (Windows XP)

2. Check that "Install from a list or specific location (Advanced)" is selected, then click **Next>**.

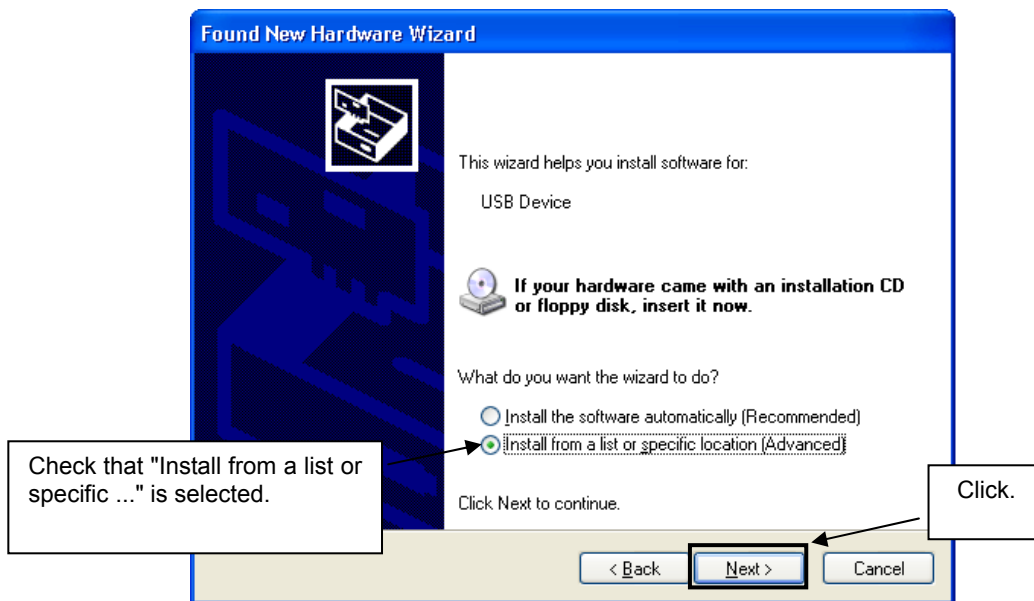

Figure 16: Found New Hardware Wizard 2 (Windows XP)

3. Check that "Search for the best driver in these locations." is selected. Select the "Include this location in the search:" check box and then click **Browse**.

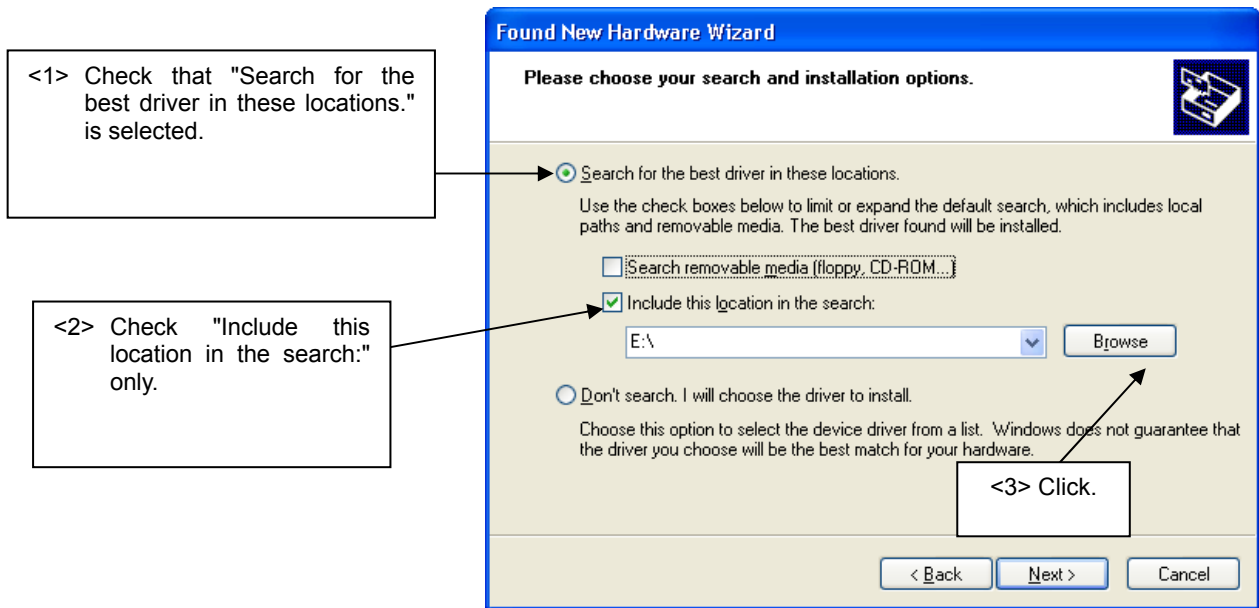

Figure 17: Search Location Specification 1 (Windows XP)

4. Locate the folder "C CDROM:\Driver" and click **OK**.

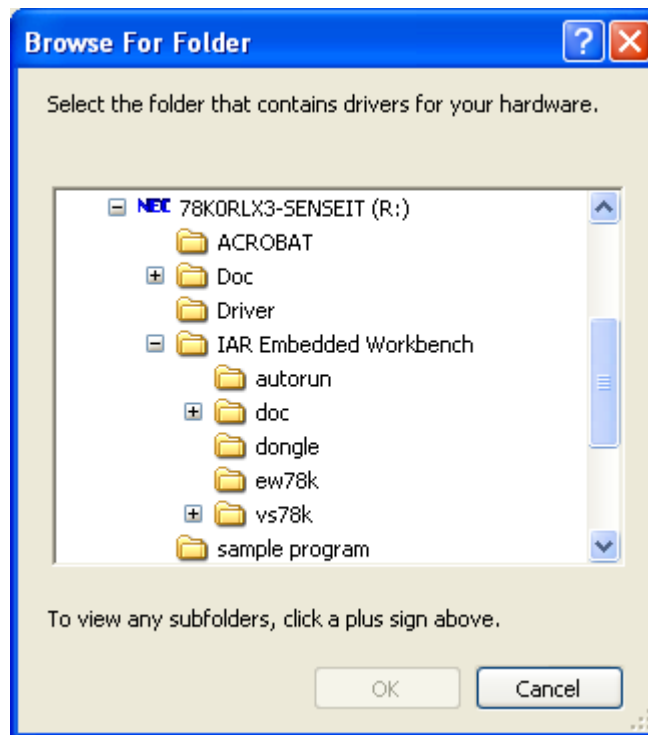

Figure 18: Search Location Specification 2 (Windows XP)

5. As shown below, "NEC Electronics Starter Kit Virtual UART has not passed Windows Logo testing to verify its compatibility with Windows XP." is displayed. Click **Continue Anyway**.



Figure 19: Windows XP Logo Testing (Windows XP)

6. After the installation of the USB driver is completed the window below is displayed. Click **Finish** to close the hardware wizard.

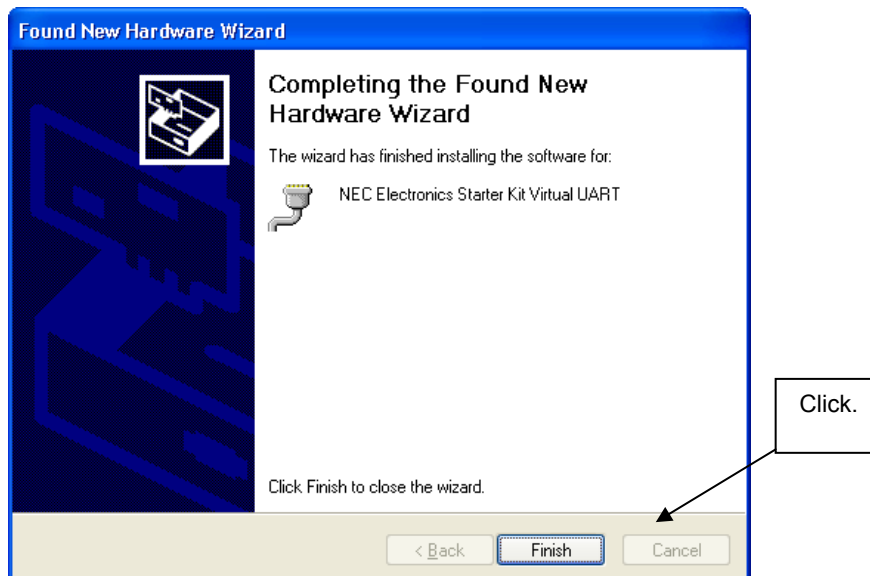

Figure 20: USB Driver Installation Completion (Windows XP)

6.6 Confirmation of USB Driver Installation

After installing the USB driver, check that the driver has been installed normally, according to the procedure below. When using the TK-78K0R/LH3+LCD board the “NEC Electronics Starter Kit Virtual UART” should be present like in the figure below.

Please check in the Windows "Device Manager" within the Windows Properties (“Hardware” tab), that the driver is installed normally.

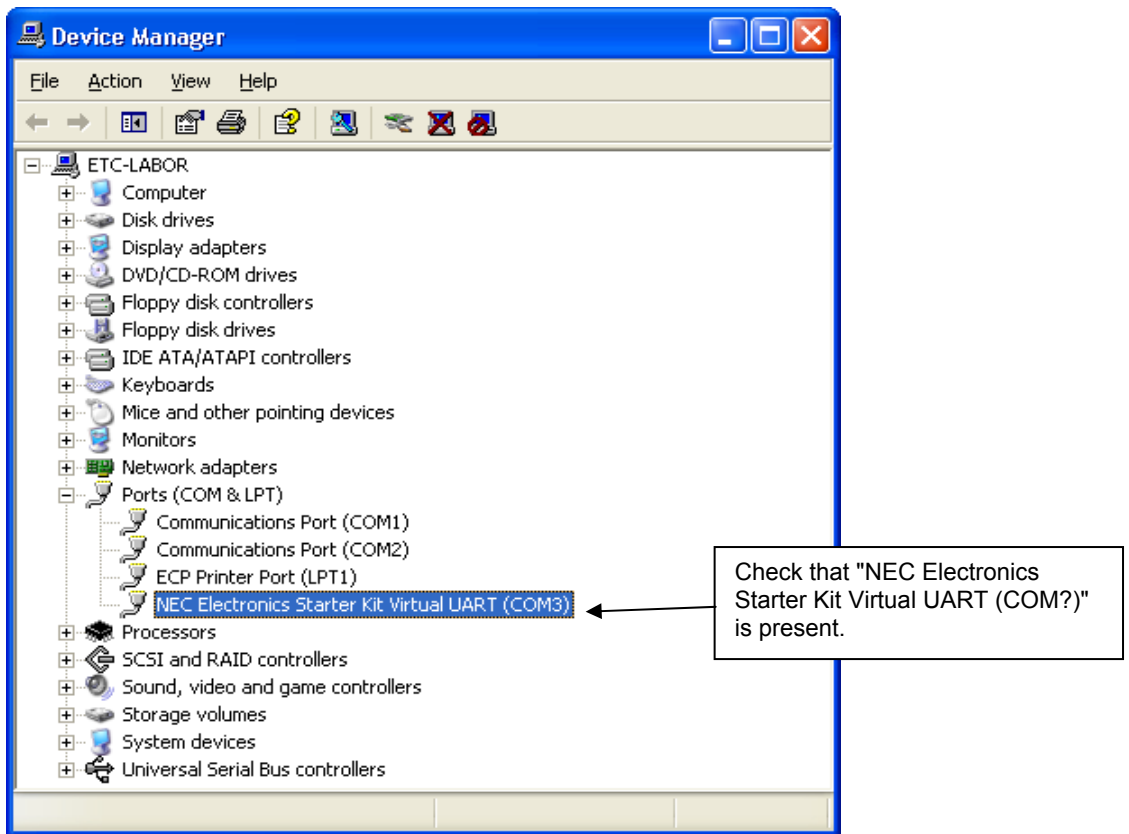

Figure 21: Windows Device Manager

7. Flash Programmer WriteEZ5

WriteEZ5 is flash programming software to flash hex files to the related device. For installation information refer to the chapter [WriteEZ5 installation](#).

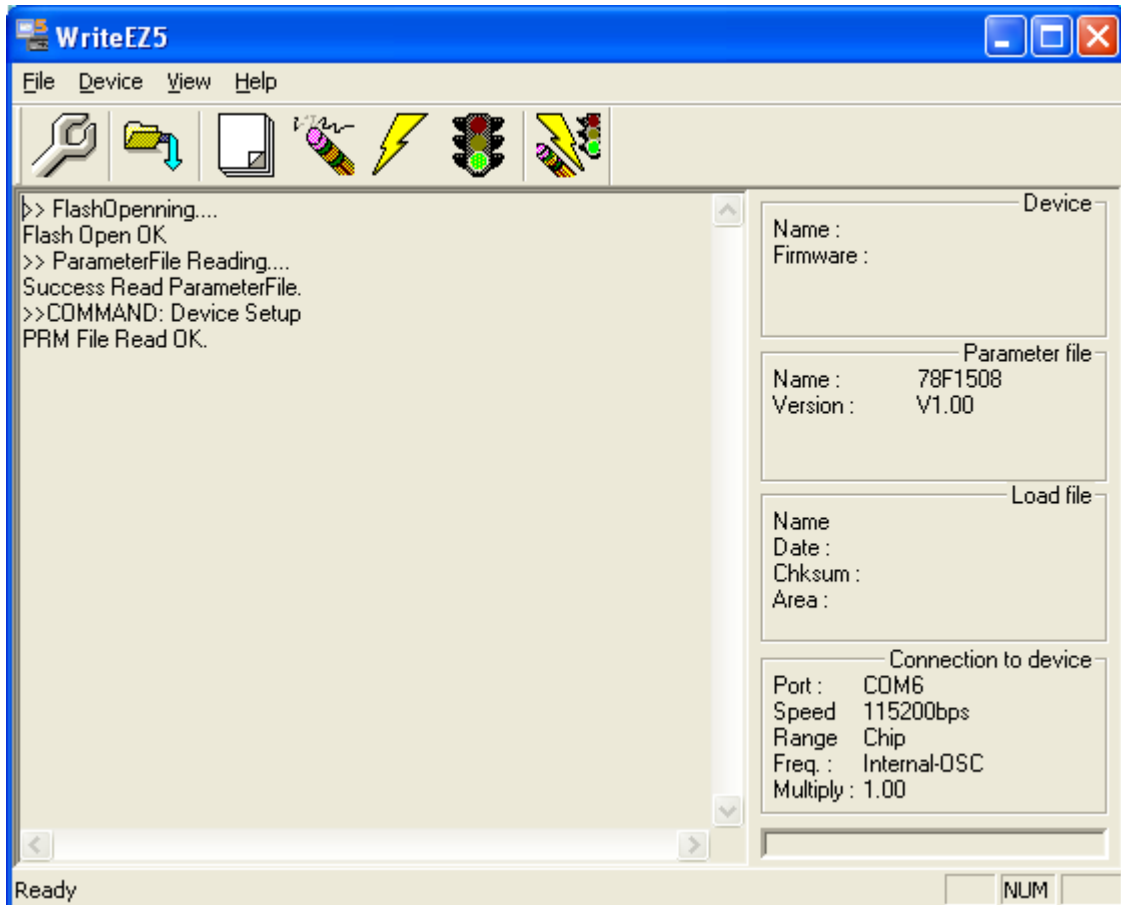

Figure 22: WriteEZ5 Startup

7.1 Device Setup

To provide all necessary information about the device to be programmed, only the corresponding flash parameter file must be loaded. The parameter file (*.prm) for the μ PD78F1508 is located on the CDROM in the same folder as the WriteEZ5 setup file. Please use the menu “**Device -> Setup...**” to open the following dialogue and the button “**PRM File Read**” to select the parameter file.

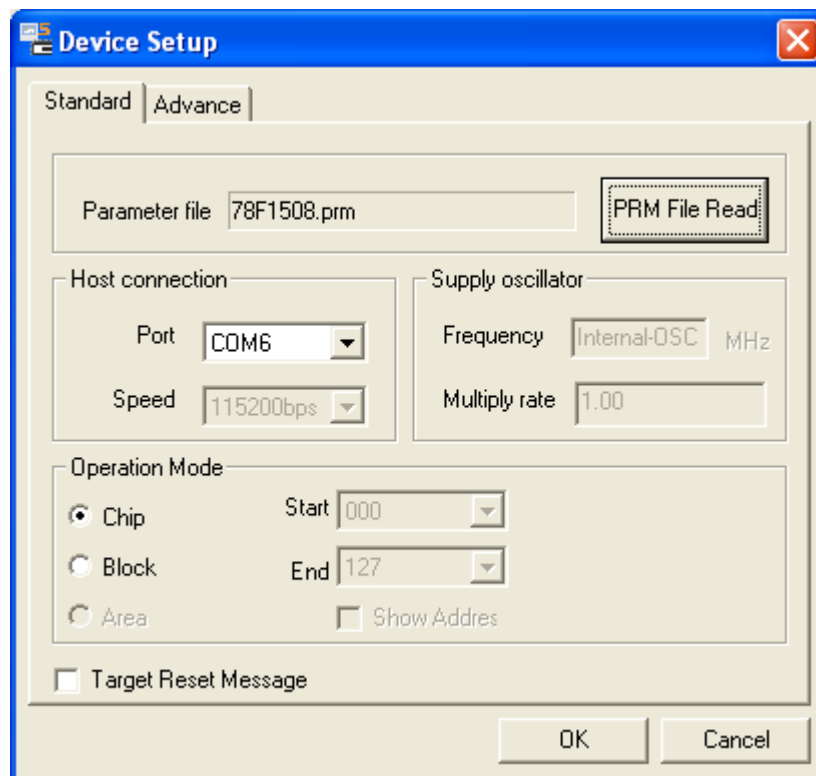

Figure 23: WriteEZ5 Device Setup Dialogue

Please check that the correct host communication port is selected. The used communication port can be seen in the [Windows Device Manager](#).

7.2 Using WriteEZ5

After a successful device selection the internal flash memory can be blank-checked, erased, programmed or verified. WriteEZ5 can be controlled either by menu or by buttons

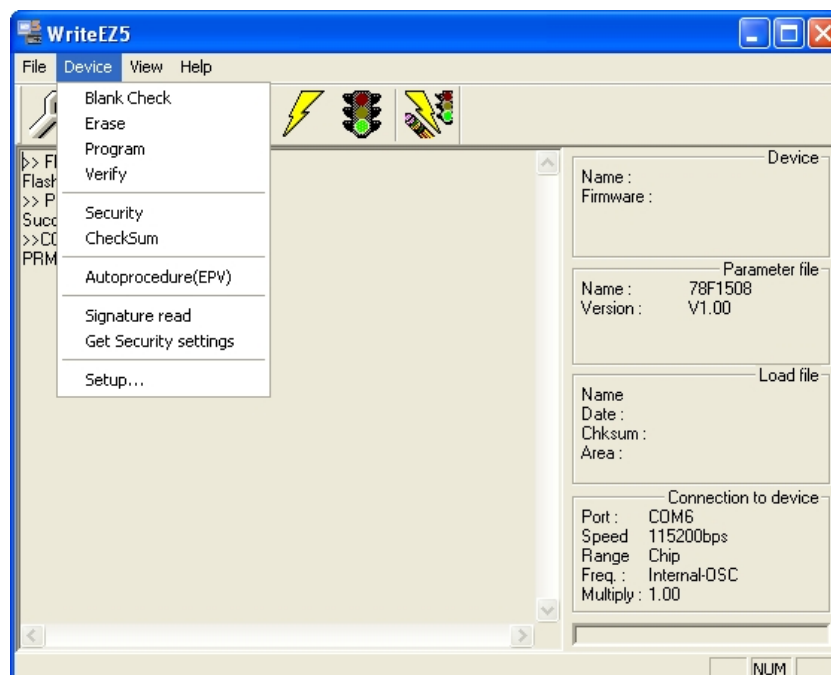

Figure 24: WriteEZ5 Device Menu







	device setup button
	load file button
	blank check button
	erase button
	program button
	verity button
	Autoprocedure button

Table 12: WriteEZ4 action buttons

WriteEZ5 supports Intel-Hex and Motorola S-record file formats as input file.

8. Voice Data Conversion Tool CvADPCM

The Voice Data Conversion Tool CvADPCM is a tool that generates ADPCM data to implement a voice application for the 78K0R/Lx3 microcontroller. Running on Microsoft Windows™, this tool converts WAV files (PCM) into ADPCM (40 kbps to 16 kbps). The result of conversion is output as a source code that can be read by the IAR Embedded Workbench for 78K.

ADPCM stands for adaptive differential PCM, and it supports the following algorithms.

- CCITT Recommendation G.726 (40 kbps, 32 kbps, 24 kbps, 16 kbps)
- NEC Electronics' ADPCM-SP (32 kbps, 24 kbps, 16 kbps)
- NEC Electronics' ADPCM-SP2 (32 kbps, 16 kbps)

Note: CvADPCM can be used on a PC on which Windows XPTM or Windows Vista™ correctly runs. This tool may not run on Windows 2000 because it uses the functions of DirectX.

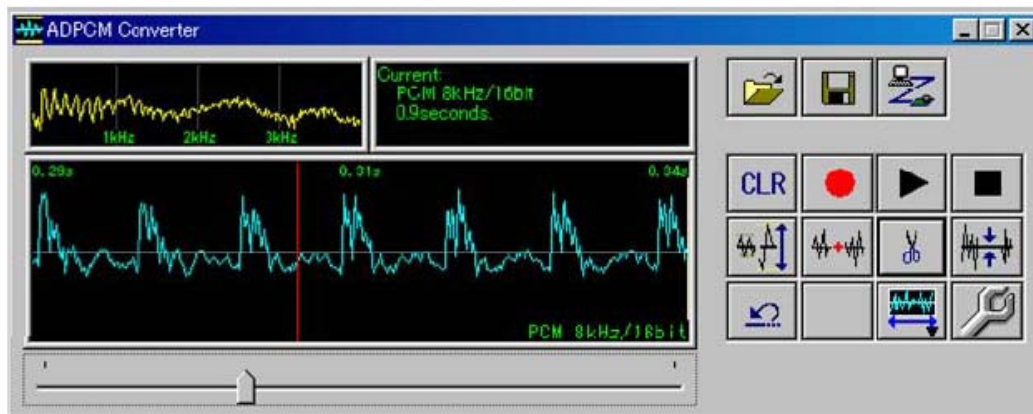

Figure 25: Voice Data Conversion Tool CvADPCM

For further information regarding the CvADPCM tool please refer to the Application note CvADPCM (U19015EJ2V0AN00.pdf) available on CDROM in the directory "Doc\CvADPCM".

9. 78K0R/Lx3 – Sense it! Sample Project

The 78K0R/Lx3 – Sense it! Demonstration kit sample project which is already programmed into the device is written to make use of the available peripherals of the TK-78K0R/LH3+LCD board. The startup sample makes use of a lot of different on chip peripherals of the 78K0R/Lx3 microcontroller 78F1508, so the real time clock, A/D- and D/A converter, Key interrupt, Timer Array Unit and LCD controller are used.

The user can use sample functions for these peripherals like Clock display, Kitchen timer, Voltmeter, Temperature measuring, Sound reproduction or current measuring of the different operation modes of the target device. Furthermore the LCD mounted on the TK-78K0R/LH3+LCD is used to guide the user through the available functions of the sample project.

9.1 Application Overview Flowchart diagram

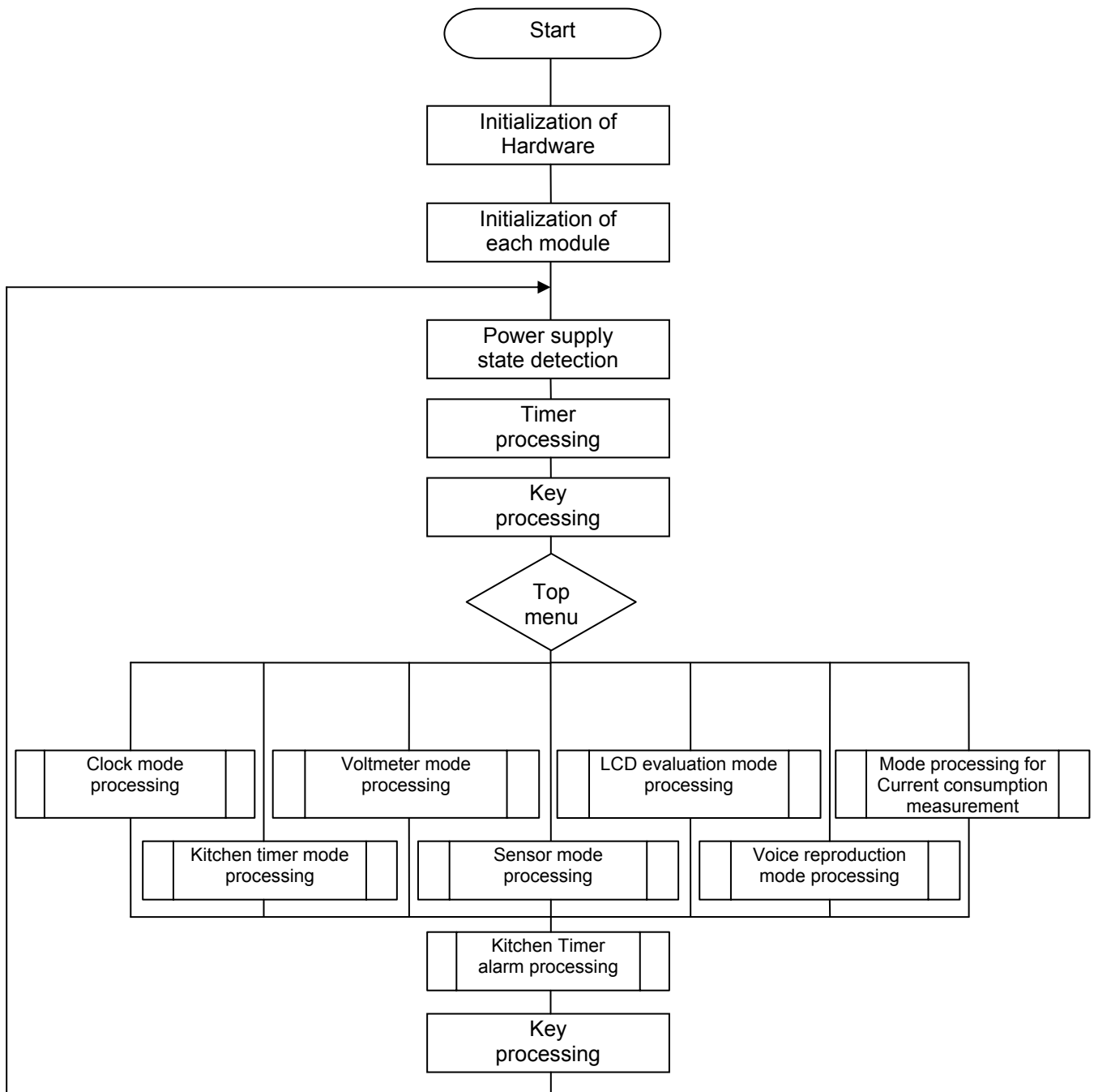

For information how to navigate through the program please refer to Sample_project_operation_manual.pdf available on the CDROM in the directory "\\Doc\TK78K0R" .

9.2 Initialization message

When the board is connect to a power supply the LCD will show up a welcome message "ALL FLASH MICROCONTROLLER 78K0R/LH3 STARTER KIT" as a ticker until the Cursor is used to leave this init screen.

9.3 Clock mode

The Clock mode can be separate in two parts, showing the actual time and setting up the time in a 12 - or 24 hour mode. The clock is displayed on the LCD and uses the RTC of the device. To generate an accurate clock reference timing the 78K0R/Lx3 sub-clock of 32.768 KHz is used.

9.4 Kitchen timer mode

The kitchen timer symbolizes a countdown timer, where the user has to set up the countdown time first and then starts the countdown. The LCD is updated by using the interval interrupt of the real time counter. After the countdown has expired a short sound is played through the audio output of the demonstration kit.

9.5 Voltmeter mode

The Voltmeter mode gives the user 2 possibilities of shown measurement results. In both cases the 12bit A/D converter is used. The 1st mode only shows the voltage, measured on the A/D converter input. The 2nd mode displays the A/D converter result added with the inverted offset input voltage 200mV, amplified 10 times. The measurable voltage range is 0.02V-0.22V with used operational amplifier and 0V – 2V without used operational amplifier.

9.6 Sensor mode

When the Sensor mode is selected the LCD shows up the measured temperature. The temperature is measured by a temperature sensor that is connected to an A/D converter input of the 78F1508 microcontroller. The result of the 12 bit A/D conversion is used as PWM duty cycle to control the brightness of LED1. The temperature can be displayed on the LCD in °Celsius as well as in Fahrenheit. The temperature range that can be measured is between - 35°C (- 30°F) and 100°C (212°F).

9.7 LCD Evaluation mode

First of all you can change the contrast of the LCD within this mode. Beside this a display test can be performed. The selected contrast is hold even if the LCD Evaluation mode is left.

The 2nd part of the LCD Evaluation mode is a display test where the different LCD driver modes can be tested.

When performing the display tests please make sure that the right hardware setup is selected for the tested mode. To check the hardware setup, please refer to chapter [2.8 LCD driver voltage](#).

Note: The Capacitance display test can not be performed if the board is battery driven.

9.8 Voice reproduction mode

In the Voice reproduction mode a pre-programmed sound sequence can be played via the 12- or 10- bit D/A converter of the microcontroller. To be able to hear the sound an audio device has to be plugged in the Jack connector J1 on the TK-78K0R/LH3+LCD board. If the kitchen timer countdown is elapsed during the sound reproduction the alarm sound is skipped and is played after the sound sequence is finished. The ADPCM library which is included in the sample project is used to extend the sound data. For further information regarding the ADPCM library please refer to the regarding Application Note (U19000EJ2V0AN00.pdf) available on the CDROM in the directory "\\Doc\CvADPCM".

9.9 Current consumption measurement mode

The Current consumption measurement mode gives the user the possibility to measure the actual current consumption. Therefore the microcontroller can be set in different operating modes.

- **Main Run:**
The microcontroller runs in normal operation but kitchen timer and other functions are stopped. LCD does not display anything while it is functioning. Make a key input to back to normal mode.
- **Sub Run:**
Stop kitchen timer, other functions, and main system clock, and switch the CPU clock to sub system clock. LCD does not display anything while it is functioned. Make a key input to back to normal mode.
- **Main Halt:**
Stop kitchen timer and other functions, and change to HALT mode. LCD does not display anything while it is functioning. Make a key input to back to normal mode.
- **Sub Halt:**
Stop kitchen timer, other functions, and main system clock, switch the CPU clock to sub system clock, and change to HALT mode. LCD does not display anything while it is functioning. Make a key input to back to normal mode.
- **Sub Halt + RTC:**
Stop kitchen timer, functions other than LCD, and main system clock, switch the CPU clock to sub system clock, and change to HALT mode. Display the LCD with constant periodic interrupt (each 0.5sec). Make a key input to back to normal mode.
- **Stop:**
Stop kitchen timer and other functions, and change to STOP mode. LCD does not display while it is functioning. Make a key input to normal mode. The clock is cleared before functioning.

10. IAR Embedded Workbench debug session

The pre-programmed sample application is also provided as an IAR Embedded Workbench project on the starter kit CDROM.

10.1 Setting up the Hardware for a debug session

To be able to perform a C-SPY debug session on the *78K0R/Lx3 Sense it!* demonstration kit board please make sure that the hardware is set up correctly. Therefore please refer to [chapter 2.1](#) and set the hardware to the **Debugging/Writing Mode**.

10.2 Load the IAR Embedded Workbench sample project

After copying the IAR sample project to the hard drive of your Host PC as described in [chapter 6.2](#) you shall be able to run this sample project.

To start the IAR Embedded Workbench 16K Kickstart for 78K click **Start → All Programs → IAR Systems → IAR Embedded Workbench for 78K v4.62 Kickstart → IAR Embedded Workbench**.

The Embedded Workbench Startup screen comes up. To open the sample project workspace press the **Open existing workspace** button and locate the **78K0RLx3-SENSEIT_sample.eww** file in the sample program folder.

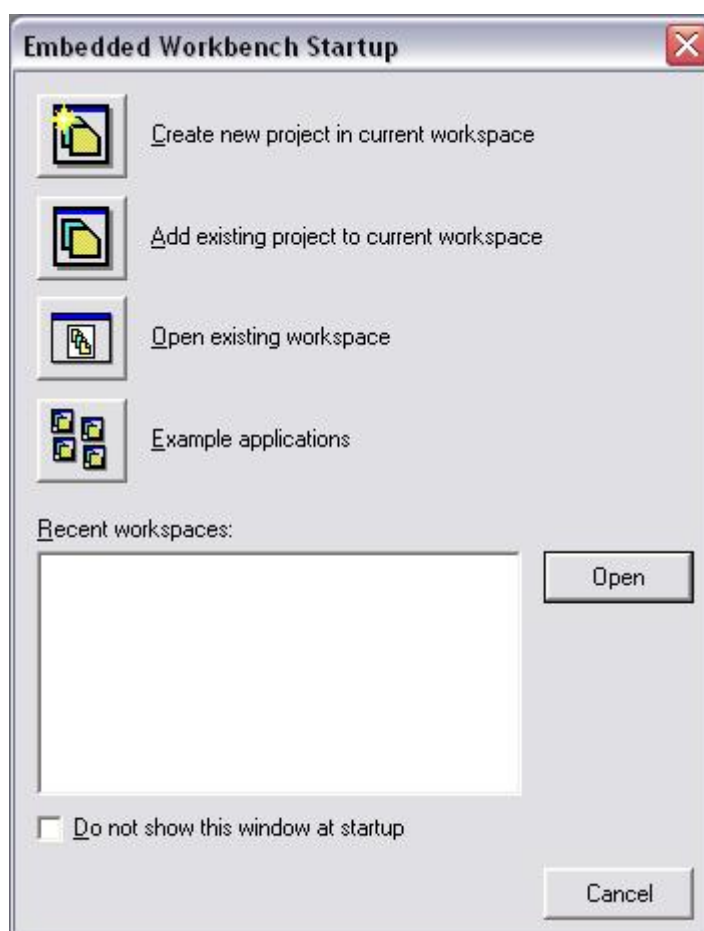

Figure 26: IAR Embedded Workbench Startup screen

The project shall show up on the left side of the IAR Embedded Workbench window in the Workspace view.

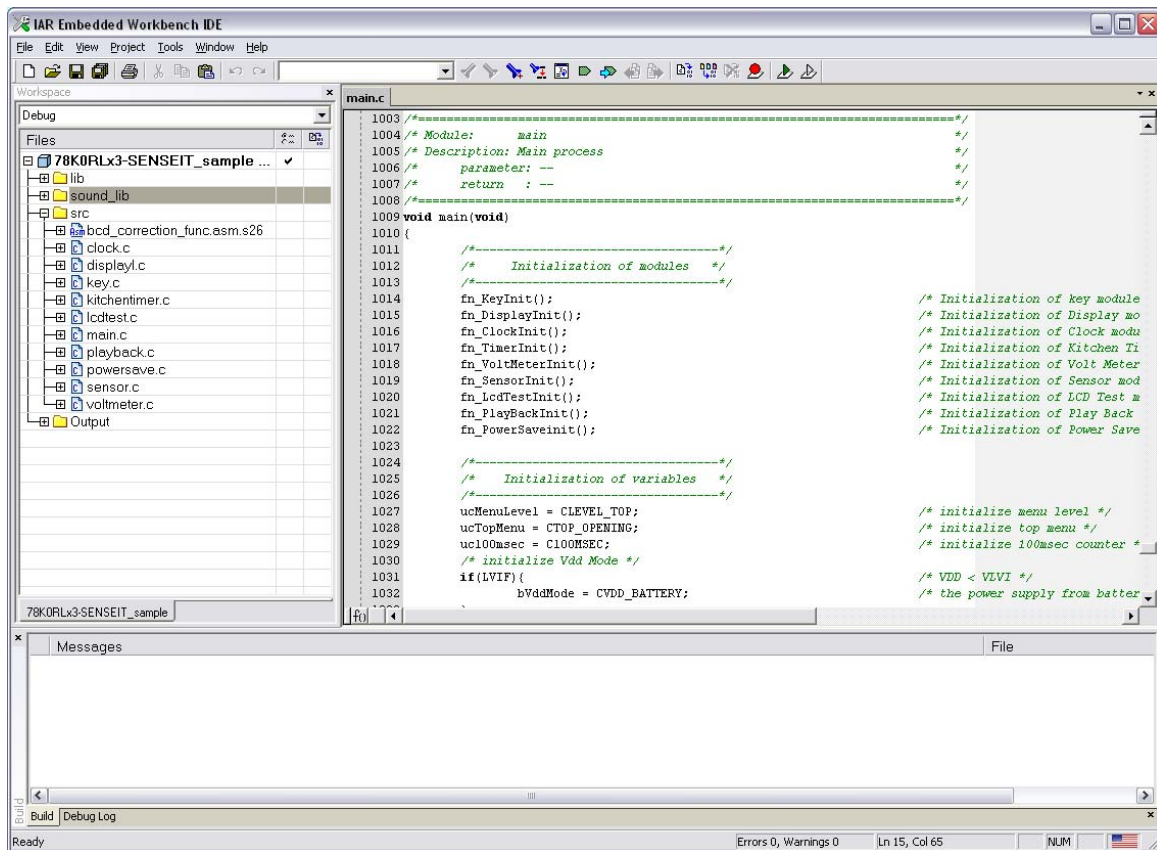

Figure 27: IAR Embedded Workbench IDE view

10.3 Build and Debug

Before build the project please check that MINICUBE is selected as Debugger Driver. Therefore open the Debugger settings by clicking **Project** → **Options** and select the Category **Debugger**.

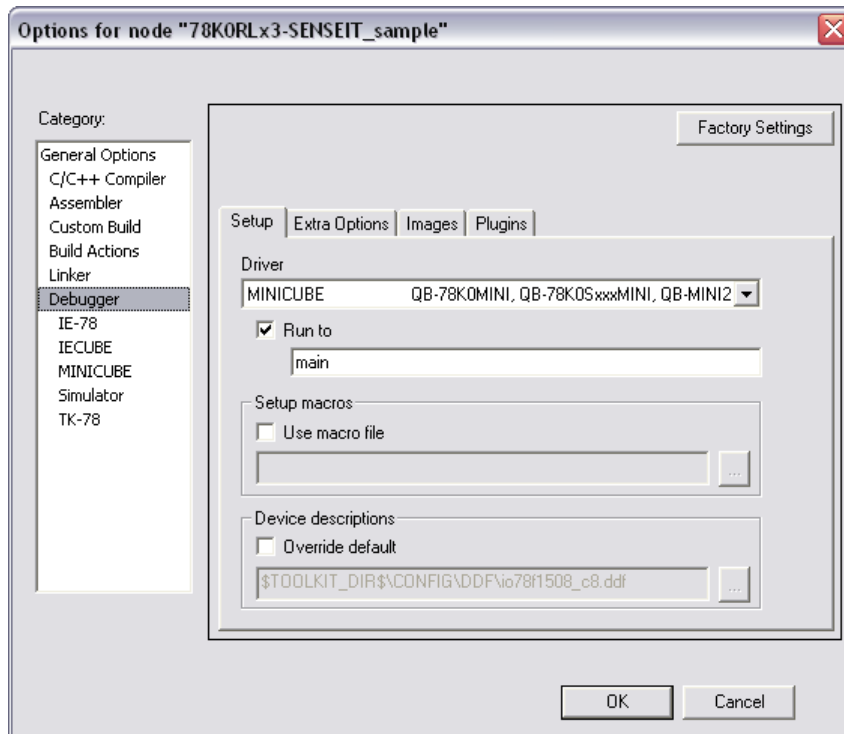



Figure 28: IAR Embedded Workbench Debugger Settings

When the TK-78K0R/LH3+LCD evaluation board is connected correctly to the Host PC and MINICUBE is selected as Debugger driver you shall be able to build, download and debug the sample project. Therefore just press the **Download and Debug** button () or click **Project → Download and Debug**. After downloading the sample project to the target device the IAR C-SPY debugger shows up and the program shall be stopped at the beginning of the **main()** function.

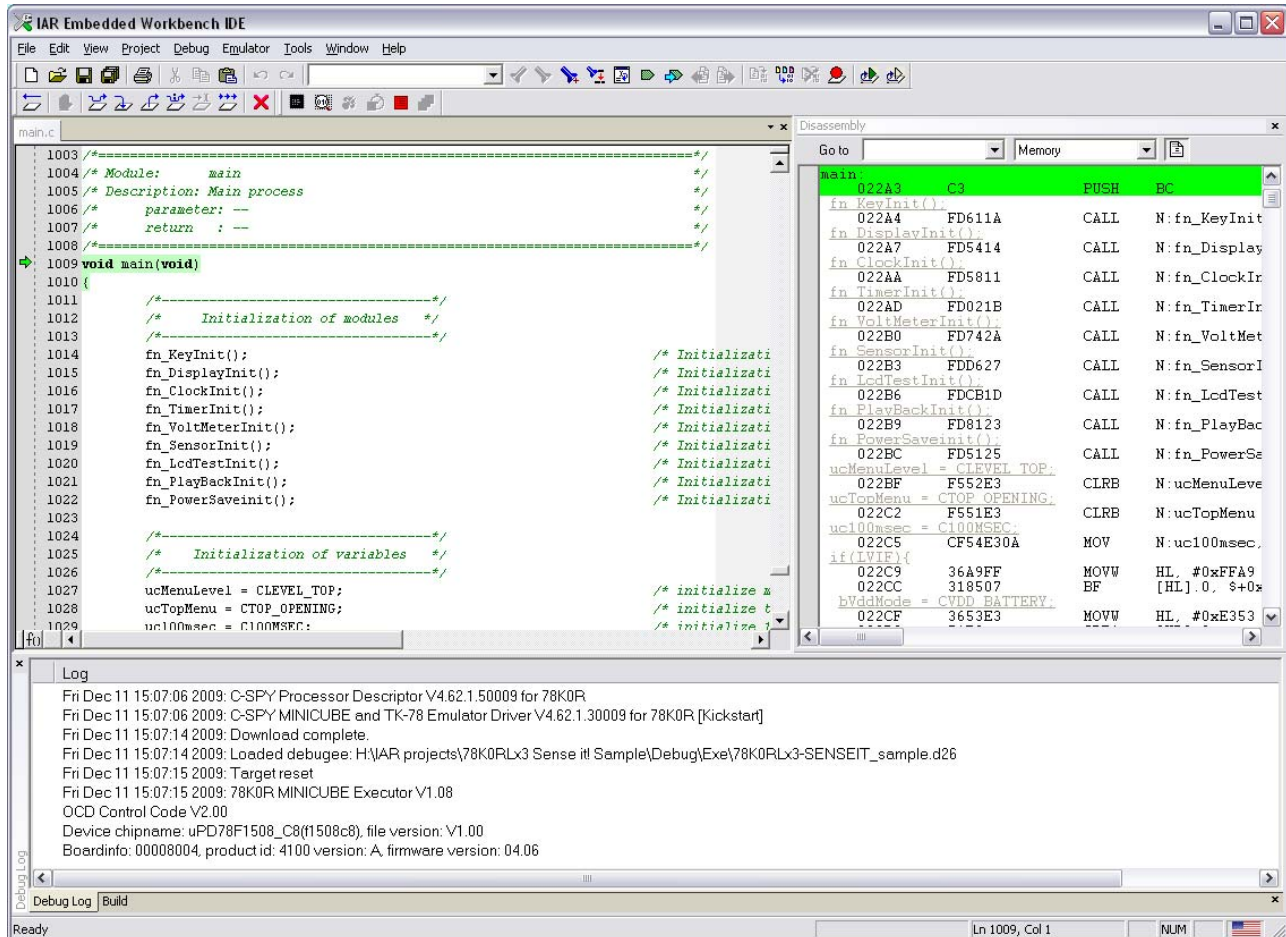



Figure 29: IAR C-SPY debugger window

To run the application press the **Run** button (). Now you can control the application as described in the chapter above. Furthermore all standard IAR C-SPY debugger functionalities for a MINICUBE debug session are available. For further information about the IAR tools please refer to the regarding IAR User's manuals available in the IAR Embedded Workbench (Help).

11. Cables

11.1 USB interface cable (Mini-B type)

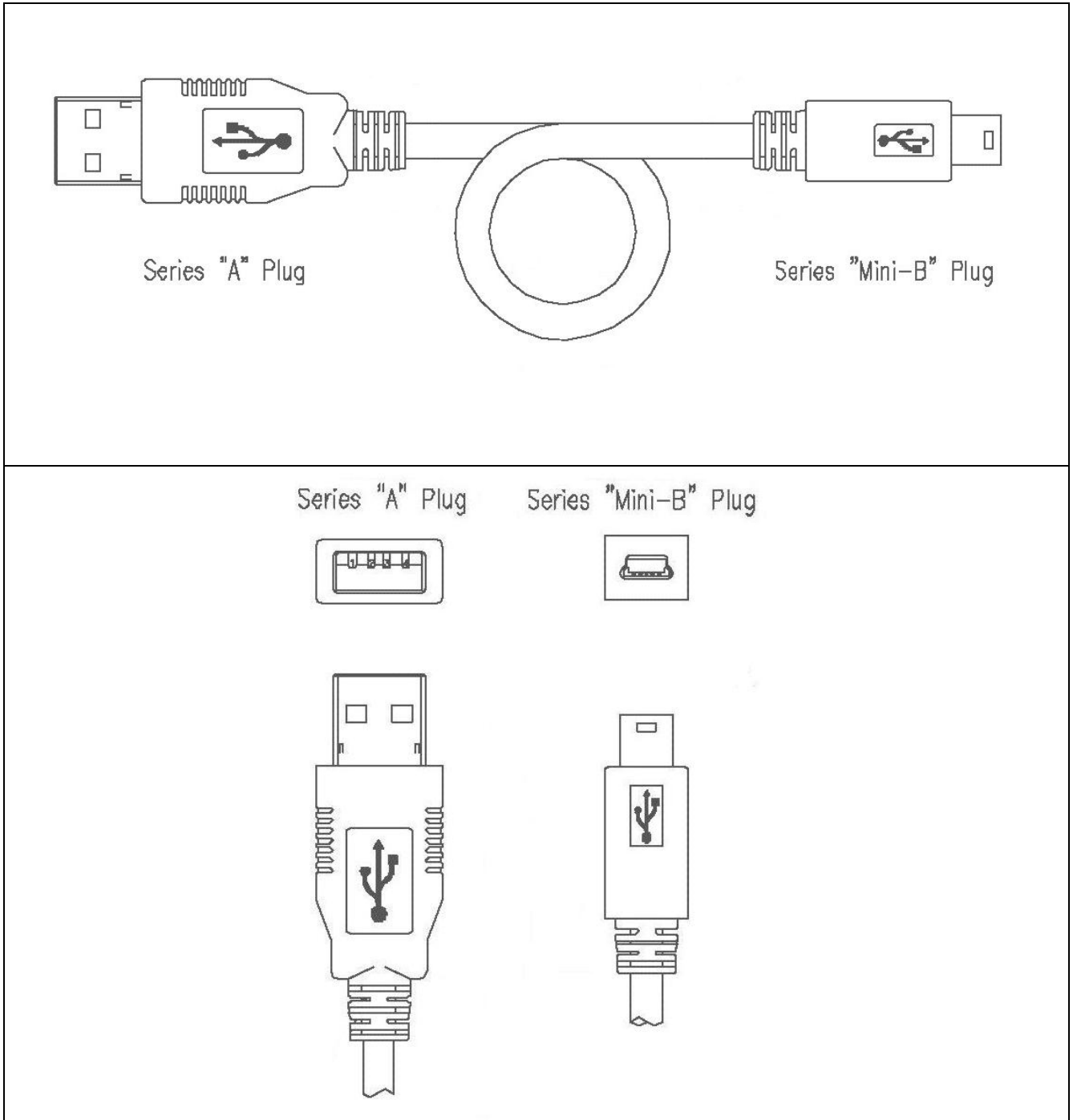

Figure 30: USB interface cable (Mini-B type)

12. Bill of materials

No.	Qty	Reference	Reference (not mounted)	Manufacturer Part No.	Manufacturer
1	1	BUZ1		PS1240P02BT	TDK
2	1	C1		F930J476MAA	nichicon
3	1	C2		0.01 μ F	
4	19	C3,C4,C7,C9,C10,C13,C14, C17,C22,C32,C36,C37,C38, C42,C43,C44,C45,C46,C47		0.1 μ F	
5	1	C5		150pF	
6	1	C6		1 μ F / 16V	
7	1	C8		0.0082 μ F	
8	1	C11		0.0039 μ F	
9	1	C12		330pF	
10	1	C15		F931C106MAA	nichicon
11	0		C16,C19,C24,C30,C34	xxx / Dip	
12	4	C18,C23,C31,C35		10 μ F / 16V	
13	1	C20		4pF	
14	1	C21		3pF	
15	8	C25,C26,C27,C28,C29,C33, C39,C41		0.47 μ F	
16	1	C40		4.7 μ F / 25V	
17	0		FP1	HIF3FC-16PA-2.54DSA	HIROSE
18	1	JP1		FFC-3AMEP1	HONDA
19	6	JP2,JP3,JP4,JP5,J5,JP6		FFC-2AMEP1	HONDA
20	1	J1		LGY6502-0900FC	SMK
21	1	J2		T-16-Red	SATO PARTS
22	1	J3		T-16-Black	SATO PARTS
23	0		J4	1060	Keystone
24	0		J6	FFC4-4AMEP1	HONDA
25	1	LCD1		A45A005X	JSC
26	1	LED1		SLR-56DU	ROHM
27	1	LED2		PG1112H	ROHM
28	1	L1		MPZ1608R391A	TDK
29	1	L2		BLM41PG750S	Murata
30	1	MR1		CN1E4K-105J	KOA
31	6	R1,R2,R6,R7,R8,R15		43K	
32	1	R3		22	
33	12	R4,R11,R14,R18,R20,R21, R22,R23,R28,R32,R38,R40		100K	
34	1	R5		220K	
35	1	R9		1K	
36	1	R10		1.2K	
37	1	R12		300	
38	1	R13		430K	
39	2	R16, R17		0	
40	1	R19		330	
41	6	R24,R25,R27,R33,R37,R39		1.5K	
42	4	R26,R30,R31,R36		10K	
43	1	R29		100	
44	2	R34,R35		27	
45	5	SW1,SW2,SW3,SW6,SW8		SSSS213000	ALPS
46	1	SW4		SKRHABE010	ALPS
47	3	SW5,SW7,SW9		CHS-04B	COPAL
48	1	SW10		SKQMBB	ALPS
49	1	SW11		SSSS223600	ALPS
50	1	USB1		UX60A-MB-5ST	HIROSE
51	1	U1		LM4890M	NS
52	1	U2		S-8120CNB	SII
53	2	U3,U6		SN74LVC2G07DCK	TI
54	1	U4		uPD78F1508GF	NECEL
55	1	U5		SN74LVC2G125DCU	TI
56	1	U7		UPD78F0730MC	NECEL

57	1	U8		SN74LVC1G125DCK	TI
58	1	U9		SN74LVC2T45DCU	TI
59	1	VR1		CT6-EP20K(203)	COPAL
60	1	Y1		CSTLS20M0X51-B0	Murata
61	1	Y2		SSP-T7-FL 3.7pF	SII
62	1	Y3		CSTCE16M0V53-R0	Murata

13. Schematics

Please find the schematics attached to this document. To open the attachments view in the Adobe Reader press the paper clip in the lower left corner of the program window. To open the attachment, double click the 78K0RLH3_LCD.pdf.

[MEMO]