

To our customers,

Old Company Name in Catalogs and Other Documents

On April 1st, 2010, NEC Electronics Corporation merged with Renesas Technology Corporation, and Renesas Electronics Corporation took over all the business of both companies. Therefore, although the old company name remains in this document, it is a valid Renesas Electronics document. We appreciate your understanding.

Renesas Electronics website: <http://www.renesas.com>

April 1st, 2010
Renesas Electronics Corporation

Issued by: Renesas Electronics Corporation (<http://www.renesas.com>)

Send any inquiries to <http://www.renesas.com/inquiry>.

Notice

1. All information included in this document is current as of the date this document is issued. Such information, however, is subject to change without any prior notice. Before purchasing or using any Renesas Electronics products listed herein, please confirm the latest product information with a Renesas Electronics sales office. Also, please pay regular and careful attention to additional and different information to be disclosed by Renesas Electronics such as that disclosed through our website.
2. Renesas Electronics does not assume any liability for infringement of patents, copyrights, or other intellectual property rights of third parties by or arising from the use of Renesas Electronics products or technical information described in this document. No license, express, implied or otherwise, is granted hereby under any patents, copyrights or other intellectual property rights of Renesas Electronics or others.
3. You should not alter, modify, copy, or otherwise misappropriate any Renesas Electronics product, whether in whole or in part.
4. Descriptions of circuits, software and other related information in this document are provided only to illustrate the operation of semiconductor products and application examples. You are fully responsible for the incorporation of these circuits, software, and information in the design of your equipment. Renesas Electronics assumes no responsibility for any losses incurred by you or third parties arising from the use of these circuits, software, or information.
5. When exporting the products or technology described in this document, you should comply with the applicable export control laws and regulations and follow the procedures required by such laws and regulations. You should not use Renesas Electronics products or the technology described in this document for any purpose relating to military applications or use by the military, including but not limited to the development of weapons of mass destruction. Renesas Electronics products and technology may not be used for or incorporated into any products or systems whose manufacture, use, or sale is prohibited under any applicable domestic or foreign laws or regulations.
6. Renesas Electronics has used reasonable care in preparing the information included in this document, but Renesas Electronics does not warrant that such information is error free. Renesas Electronics assumes no liability whatsoever for any damages incurred by you resulting from errors in or omissions from the information included herein.
7. Renesas Electronics products are classified according to the following three quality grades: “Standard”, “High Quality”, and “Specific”. The recommended applications for each Renesas Electronics product depends on the product’s quality grade, as indicated below. You must check the quality grade of each Renesas Electronics product before using it in a particular application. You may not use any Renesas Electronics product for any application categorized as “Specific” without the prior written consent of Renesas Electronics. Further, you may not use any Renesas Electronics product for any application for which it is not intended without the prior written consent of Renesas Electronics. Renesas Electronics shall not be in any way liable for any damages or losses incurred by you or third parties arising from the use of any Renesas Electronics product for an application categorized as “Specific” or for which the product is not intended where you have failed to obtain the prior written consent of Renesas Electronics. The quality grade of each Renesas Electronics product is “Standard” unless otherwise expressly specified in a Renesas Electronics data sheets or data books, etc.
 - “Standard”: Computers; office equipment; communications equipment; test and measurement equipment; audio and visual equipment; home electronic appliances; machine tools; personal electronic equipment; and industrial robots.
 - “High Quality”: Transportation equipment (automobiles, trains, ships, etc.); traffic control systems; anti-disaster systems; anti-crime systems; safety equipment; and medical equipment not specifically designed for life support.
 - “Specific”: Aircraft; aerospace equipment; submersible repeaters; nuclear reactor control systems; medical equipment or systems for life support (e.g. artificial life support devices or systems), surgical implantations, or healthcare intervention (e.g. excision, etc.), and any other applications or purposes that pose a direct threat to human life.
8. You should use the Renesas Electronics products described in this document within the range specified by Renesas Electronics, especially with respect to the maximum rating, operating supply voltage range, movement power voltage range, heat radiation characteristics, installation and other product characteristics. Renesas Electronics shall have no liability for malfunctions or damages arising out of the use of Renesas Electronics products beyond such specified ranges.
9. Although Renesas Electronics endeavors to improve the quality and reliability of its products, semiconductor products have specific characteristics such as the occurrence of failure at a certain rate and malfunctions under certain use conditions. Further, Renesas Electronics products are not subject to radiation resistance design. Please be sure to implement safety measures to guard them against the possibility of physical injury, and injury or damage caused by fire in the event of the failure of a Renesas Electronics product, such as safety design for hardware and software including but not limited to redundancy, fire control and malfunction prevention, appropriate treatment for aging degradation or any other appropriate measures. Because the evaluation of microcomputer software alone is very difficult, please evaluate the safety of the final products or system manufactured by you.
10. Please contact a Renesas Electronics sales office for details as to environmental matters such as the environmental compatibility of each Renesas Electronics product. Please use Renesas Electronics products in compliance with all applicable laws and regulations that regulate the inclusion or use of controlled substances, including without limitation, the EU RoHS Directive. Renesas Electronics assumes no liability for damages or losses occurring as a result of your noncompliance with applicable laws and regulations.
11. This document may not be reproduced or duplicated, in any form, in whole or in part, without prior written consent of Renesas Electronics.
12. Please contact a Renesas Electronics sales office if you have any questions regarding the information contained in this document or Renesas Electronics products, or if you have any other inquiries.

(Note 1) “Renesas Electronics” as used in this document means Renesas Electronics Corporation and also includes its majority-owned subsidiaries.

(Note 2) “Renesas Electronics product(s)” means any product developed or manufactured by or for Renesas Electronics.

SH7670 CPU Board M3A-HS71

Installation Manual



Renesas 32-Bit RISC Microcomputers
SuperH™ RISC engine Family/SH7670 Series

Notes regarding these materials







1. This document is provided for reference purposes only so that Renesas customers may select the appropriate Renesas products for their use. Renesas neither makes warranties or representations with respect to the accuracy or completeness of the information contained in this document nor grants any license to any intellectual property rights or any other rights of Renesas or any third party with respect to the information in this document.
2. Renesas shall have no liability for damages or infringement of any intellectual property or other rights arising out of the use of any information in this document, including, but not limited to, product data, diagrams, charts, programs, algorithms, and application circuit examples.
3. You should not use the products or the technology described in this document for the purpose of military applications such as the development of weapons of mass destruction or for the purpose of any other military use. When exporting the products or technology described herein, you should follow the applicable export control laws and regulations, and procedures required by such laws and regulations.
4. All information included in this document such as product data, diagrams, charts, programs, algorithms, and application circuit examples, is current as of the date this document is issued. Such information, however, is subject to change without any prior notice. Before purchasing or using any Renesas products listed in this document, please confirm the latest product information with a Renesas sales office. Also, please pay regular and careful attention to additional and different information to be disclosed by Renesas such as that disclosed through our website. (<http://www.renesas.com>)
5. Renesas has used reasonable care in compiling the information included in this document, but Renesas assumes no liability whatsoever for any damages incurred as a result of errors or omissions in the information included in this document.
6. When using or otherwise relying on the information in this document, you should evaluate the information in light of the total system before deciding about the applicability of such information to the intended application. Renesas makes no representations, warranties or guaranties regarding the suitability of its products for any particular application and specifically disclaims any liability arising out of the application and use of the information in this document or Renesas products.
7. With the exception of products specified by Renesas as suitable for automobile applications, Renesas products are not designed, manufactured or tested for applications or otherwise in systems the failure or malfunction of which may cause a direct threat to human life or create a risk of human injury or which require especially high quality and reliability such as safety systems, or equipment or systems for transportation and traffic, healthcare, combustion control, aerospace and aeronautics, nuclear power, or undersea communication transmission. If you are considering the use of our products for such purposes, please contact a Renesas sales office beforehand. Renesas shall have no liability for damages arising out of the uses set forth above.
8. Notwithstanding the preceding paragraph, you should not use Renesas products for the purposes listed below:
 - (1) artificial life support devices or systems
 - (2) surgical implantations
 - (3) healthcare intervention (e.g., excision, administration of medication, etc.)
 - (4) any other purposes that pose a direct threat to human lifeRenesas shall have no liability for damages arising out of the uses set forth in the above and purchasers who elect to use Renesas products in any of the foregoing applications shall indemnify and hold harmless Renesas Technology Corp., its affiliated companies and their officers, directors, and employees against any and all damages arising out of such applications.
9. You should use the products described herein within the range specified by Renesas, especially with respect to the maximum rating, operating supply voltage range, movement power voltage range, heat radiation characteristics, installation and other product characteristics. Renesas shall have no liability for malfunctions or damages arising out of the use of Renesas products beyond such specified ranges.
10. Although Renesas endeavors to improve the quality and reliability of its products, IC products have specific characteristics such as the occurrence of failure at a certain rate and malfunctions under certain use conditions. Please be sure to implement safety measures to guard against the possibility of physical injury, and injury or damage caused by fire in the event of the failure of a Renesas product, such as safety design for hardware and software including but not limited to redundancy, fire control and malfunction prevention, appropriate treatment for aging degradation or any other applicable measures. Among others, since the evaluation of microcomputer software alone is very difficult, please evaluate the safety of the final products or system manufactured by you.
11. In case Renesas products listed in this document are detached from the products to which the Renesas products are attached or affixed, the risk of accident such as swallowing by infants and small children is very high. You should implement safety measures so that Renesas products may not be easily detached from your products. Renesas shall have no liability for damages arising out of such detachment.
12. This document may not be reproduced or duplicated, in any form, in whole or in part, without prior written approval from Renesas.
13. Please contact a Renesas sales office if you have any questions regarding the information contained in this document, Renesas semiconductor products, or if you have any other inquiries.

[Indication of Warnings and Cautions]

The following explains the warnings and cautions indicated for the handling of the product.

 WARNING	If the product is improperly handled without regard for this indication, there will be a possibility of inflicting death or heavy wound on persons.
 CAUTION	If the product is improperly handled without regard for this indication, there will be a possibility of inflicting an injury on persons or physical damage.
IMPORTANT	Indicates other important information to be observed when using the product.

In addition to the above, the following will be indicated as necessary.

The  mark indicates a warning or caution. Example:  Be Careful About Electric Shock
The  mark indicates a prohibition. Example:  Do Not Disassemble
The  mark indicates a compulsory or directive instruction. Example:  Unplug from Socket

Important

Before using this product, be sure to read the user's manual (this user's manual) carefully. Keep this user's manual, and refer to this when you have questions about this product.

About this product:

The term "this product" referred to here mean the product manufactured by Renesas Technology Corporation.

It does not include the user systems and host machines of the customers.

Purpose of use of this product:

This product is developed for experiencing the development environment and specification of the Renesas 32-bit RISC MCU SuperH RISC engine family /SH7670. Be sure to use this product correctly according to said purpose of use. Please avoid using this product for other than its intended purpose of use.

For those who use this product:

This product can only be used by those who have carefully read the user's manual and know how to use it. Use of this product requires the basic knowledge of electric circuits, logical circuits, and MCUs.

When using this product:

(1) This product is a development supporting unit for use in your program development and evaluation stages.

In mass-producing your program you have finished developing, be sure to make a judgment on your own risk that it can be put to practical use by performing integration test, evaluation, or some experiment else.

(2) In no event shall Renesas Solutions Corp. be liable for any consequence arising from the use of this product.

(3) This product has been developed by assuming its use for program development and evaluation in laboratories. Therefore, it does not fall under the application of Electrical Appliance and Material Safety Law and protection against electromagnetic interference when used in Japan.

(4) Renesas Solutions Corp. cannot predict all possible situations or possible cases of misuse where a potential danger exists. Therefore, the warnings written in this user's manual and the warning labels attached to this product do not necessarily cover all of such possible situations or cases. Please be sure to use this product correctly and safely on your own responsibility.

(5) This product is designed for use in program development and evaluation stages. It cannot be embedded in your product for mass-production purposes.

(6) Even if this product has a deficiency in its internal microcomputer, it will not be replaced with a product which has had the microcomputer deficiencies corrected.

(7) No parts incorporated in this product may be dismantled for diverted use in other products.

(8) For the products with socket mounted, it is likely to become a loose connection by the vibration and the shocking In this case, please reinstalls IC again.

Usage restrictions:

This product has been developed as a means of supporting system development by users. Therefore, do not use it as a device used for equipment-embedded applications. Also, do not use it for developing the systems or equipment used for the following purposes either:

- (1) Transportation and vehicular
- (2) Medical (equipment where human life is concerned)
- (3) Aerospace
- (4) Nuclear power control
- (5) Undersea repeater

If you are considering the use of this product for one of the above purposes, please be sure to consult your local distributor.

About product changes:

We are constantly making efforts to improve the design and performance of this product. Therefore, the specification or design of this product or its user's manual may be changed without prior notice.

About the rights:

- (1) We assume no responsibility for any damage or infringement on patent rights or any other rights arising from the use of any information, products or circuits presented in this user's manual.
- (2) The information or data in this user's manual does not implicitly or otherwise grant a license for patent rights or any other rights belonging to us or third parties.
- (3) This user's manual and this product are copyrighted, with all rights reserved by us. This user's manual may not be copied, duplicated or reproduced, in whole or part, without prior written consent of us.

About diagrams:

The diagrams in this user's manual may not all represent exactly the actual object.

Table of Contents

CHAPTER1 BEFORE USING THE SH7670 CPU BOARD	1-1
1.1 Overview	1-2
1.2 Usage Precautions	1-2
1.2.1 Symbols Used	1-3
1.3 Procedure for Introducing This Product.....	1-4
1.4 Operating Guarantee for This Product	1-4
1.5 Items to Be Prepared by User	1-5
1.5.1 Recommended Host Computer Environment	1-5
CHAPTER2 SETTING UP THE HARDWARE	2-1
2.1 Connections Between SH7670 CPU board and E10A-USB Emulator	2-2
2.2 SH7670 CPU board Switch Setting	2-2
2.2.1 SH7670 CPU board DIP Switch Setting	2-3
2.2.2 SH7670 CPU Board Jumper Switch Setting	2-3
2.3 System Connections and Power-On Sequence	2-4
2.4 Procedure for Disconnecting System Power Supply	2-4
CHAPTER3 SETTING UP THE SOFTWARE	3-1
3.1 About the HEW	3-2
3.1.1 HEW Installation Procedure.....	3-2
3.2 Setting Up the E10A-USB Emulator Software.....	3-5
3.2.1 E10A-USB Software Installation Procedure.....	3-5
3.2.2 Setting Up the E10A-USB Emulator	3-9
CHAPTER4 RUNNING THE SOFTWARE	4-1
4.1 Running the Software.....	4-2
4.1.1 Preparing for Downloading the Sample Software	4-2
4.1.2 SH7670 CPU board and E10A-USB Startup Procedure (HEW Startup)	4-2
4.1.3 E10A-USB Emulator Connection Error Dialog.....	4-6
4.1.4 Sample Software Download Procedure	4-8
CHAPTER5 CREATING AND RUNNING A NEW PROJECT WORKSPACE	5-1
5.1 Creating a New Project Workspace	5-2
5.1.1 Preparing for Creating a New Project Workspace	5-2
5.1.2 Procedure for Creating a New Project Workspace	5-2
5.2 Setting Up the Flash Memory Download.....	5-8
5.2.1 Setting Up the Flash Memory Download Function.....	5-8
5.2.2 Specifying the Command Batch File Before Downloading.....	5-9

5.2.3 Activating the Command Line Window	5-10
5.3 Adding/Modifying Hardware Setup Files	5-10
5.3.1 Copying Hardware Setup Files	5-10
5.3.2 Removing the Standard Source Files	5-10
5.3.3 Adding Hardware Setup Files	5-11
5.3.4 Setting Compiler Options.....	5-13
5.3.5 Setting Linker Options	5-14
5.3.6 Writing the Main Function (Operation Confirmation).....	5-21

This page is blank

Chapter1

Before Using the SH7670 CPU Board

1.1 Overview

The SH7670 CPU board (board type name: M3A-HS71) consists of the SH7670 CPU board and the sample software.

This installation manual describes mainly how to set up the SH7670 CPU board hardware and software. For more information about SH7670 hardware and programming manual, refer to the manuals in CD-ROM included with this product.

If there is anything that you notice about the package contents of this product, please contact Renesas Technology Corporation, Renesas Solutions Corporation, or Renesas Technology Sales Co., Ltd. or its distributor.

To Ensure Safe and Correct Use

Safety precaution:



- This manual uses various pictorial indications to ensure the correct use of the product and thereby prevent inflicting an injury on users or other people or causing damage to property.
- These pictorial indications are explained in the section 1.2, "Usage Precautions." Please be sure to understand the contents written in that section before you use the product.

1.2 Usage Precautions

The precautions described here must be observed in order to prevent inflicting an injury on users or other people or causing damage to property, and to ensure that this product is used safely.

To ensure the correct use, be sure to read these precautions and understand the written contents before you use the product. Not all precautions described in this manual relate to the Renesas product alone, some of them apply to an entire personal computer system incorporating the Renesas product also.

The following explains the warnings and cautions indicated for the handling of this product.

<Warning Indication>

WARNING

Regarding the handling of this product:



- Do not use this product outdoors. It can only be used indoors.
- Do not let foreign matters such as water, pieces of metal or inflammable material get into the board or connectors.

Regarding installation:



- Do not install the product in humid or wet places. Should water get into the internal circuit of the product, an unrecoverable fault may result.

Regarding the working environment:



- The upper-limit ambient temperature at which this product can be used (i.e., rated maximum ambient temperature) is 50°C. Make sure this rated maximum ambient temperature is not exceeded.

<Caution Indication>

CAUTION

Regarding the reconstruction of this product:

 • Do not reconstruct this product. If the product has gotten out of order for reasons of disassembly or reconstruction, requests for repair may not be accepted.

Regarding the handling of this product:

 • Handle this product with caution, not to let it drop or fall down or apply strong mechanical shock.

• Do not touch the communication interface connector pins or other connector pins directly with your hand. The internal circuit may be broken by static electricity.

• When moving this product to another place of installation, be careful not to apply strong vibration or mechanical shock to it.

• After connecting each piece of equipment with cable, check the cables again to see that they are connected correctly. For details on how to connect, refer to Chapter 2, "Setting Up the Hardware."

• Before turning on the power for each connected piece of equipment, make sure you've finished connecting all cables. Do not connect or disconnect any cable when the power is turned on.

Regarding the operating procedure for this product:

Note • Exceptional conditions or precautions are noted in an operation procedure or explanatory description when it is necessary to call the user's attention.

1.2.1 Symbols Used

Table 1.2.1 lists the symbols used in this manual.

Table 1.2.1 Symbol List

Symbol	Meaning
[Menu->Menu Option]	The arrow "→" indicates a menu option. Example: File menu→Save As...
"File name" "Directory" "Button"	" ... " indicates file names, directory, or button of dialog box. Example : "C:¥Workspace¥Sample_softwawe¥ SH7670_sample " "OK" button "resetprg.c"

1.3 Procedure for Introducing This Product

In this manual, we follow the procedure outlined in Figure 1.3.1 to perform the installation.

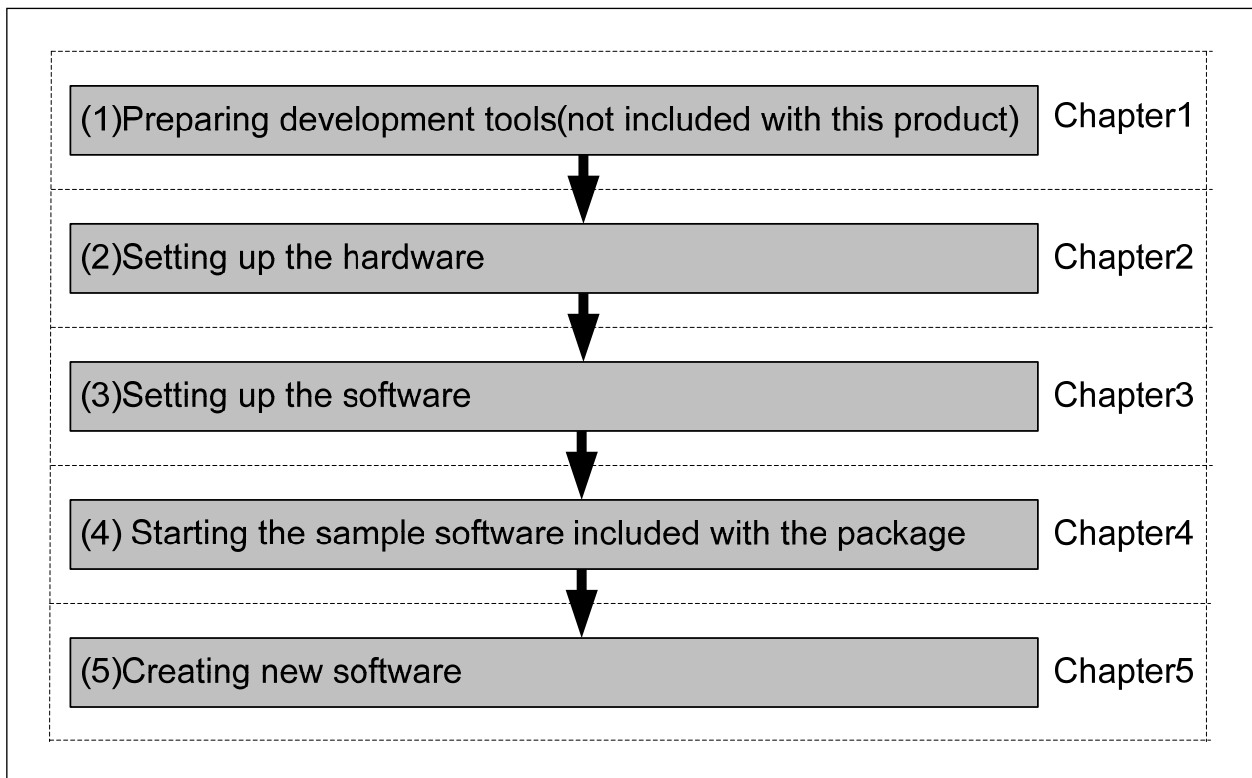

Figure 1.3.1 SH7670 CPU board Installation Procedure

1.4 Operating Guarantee for This Product

This product (hardware and software) was developed for only helping users get hands-on experience on the functionality and development environment of the SH7670, and does not guarantee the results arising from the use of it.

The SH7670 CPU board has the type of host computer designated as its operating environment (IBM PC/AT and its compatible). This only indicates the operating environment assumed by Renesas, and does not guarantee that the SH7670 CPU board will operate normally in all relevant types of machines or in all relevant environments (e.g., device driver and peripheral device).

1.5 Items to Be Prepared by User

The following lists the items that need to be prepared by users separately from this product.

<For SH7670 CPU board>

You need to prepare the following power supply separately from the product package in order to supply power to the SH7670 CPU board.

Table 1.5.1 Items to Be Prepared by User (For SH7670 CPU board)

No.	Item to Be Prepared by User	Remark
1	5 V DC output stabilizing power supply	1.5 A or more

<For the Development Environment>

The installation described here uses the tools made by Renesas.

To use this product following the installation, you need to prepare some items separately from the product package. The table below lists the tools made by Renesas that users should prepare.

Table 1.5.2 Items to Be Prepared by User (Renesas Tools)

No.	Item to Be Prepared by User	Product Type Name	Applicable Version
2	E10A-USB emulator for the SuperH family	HS0005KCU02H or HS0005KCU01H	One that supports the SH-2A
3	SuperH RISC engine C/C++ compiler package	R0C40700XSW09R	Ver.9.00 release01 or more
4	Integrated development environment tool, HEW (High-performance Embedded Workshop)	-	Ver.4.03.00 or more

Notes:

- If you already have the E10A-USB emulator main unit and are using any device group other than the SH-2A group, you need to purchase an “additional device group license tool” separately from the product package.
- For details on how to set up a new device group in the E10A-USB emulator, refer to Section 3.2.2, “Setting Up the E10A-USB Emulator” in Chapter 3 of this manual.

1.5.1 Recommended Host Computer Environment

To use the above Renesas tools, we recommend using the host computer and the OS version listed in Table 1.5.3 below.

Table 1.5.3 Operating Environment for the Renesas Development Tools

Host Computer Specification	IBM PC/AT Series and Compatibles
CPU	IBM PC and its compatible incorporating Pentium III or later (600 MHz or greater recommended) and USB 1.1/2.0 (Full Speed)
Memory	128 MB or more (at least twice the load module size recommended)
Hard disk capacity	Installation requires 100 MB or more of hard disk capacity. (With the swap area taken into consideration, at least twice the memory size must be available (four times or more recommended).)
OS	Windows 2000, WindowsXP

This page is blank

Chapter2
Setting Up the Hardware

2.1 Connections Between SH7670 CPU board and E10A-USB Emulator

Figure 2.1.1 shows how SH7670 CPU board and E10A-USB emulator should be connected.

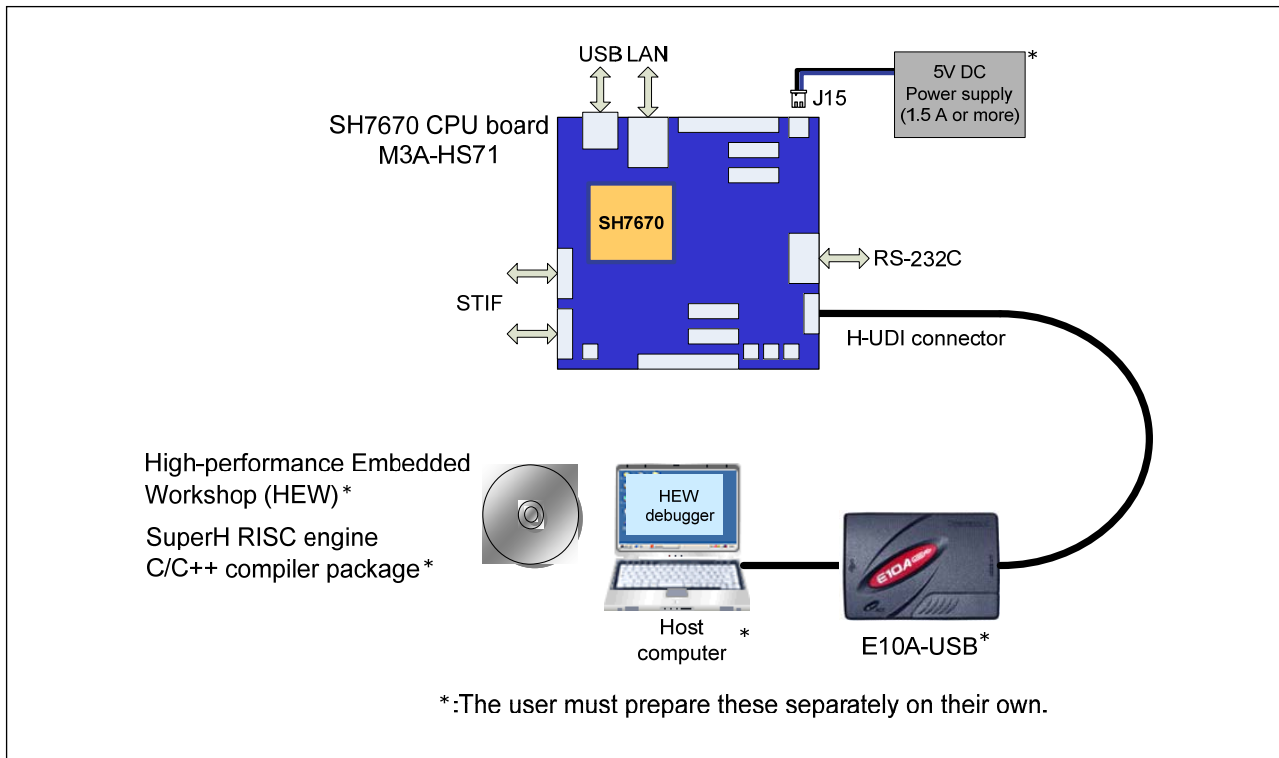



Figure 2.1.1 System Connection of SH7670 CPU board and E10A-USB Emulator

2.2 SH7670 CPU board Switch Setting

The following describes how to set the switches of SH7670 CPU board.

CAUTION



- Do not change DIP switch and jumper settings while the SH7670 CPU board is operating. Always be sure to turn off the power before changing DIP switch or jumper settings. This is necessary to prevent unrecoverable damage to the SH7670 CPU board that may otherwise occur.

To use the SH7670 CPU board following the installation described here, be sure to set the DIP switch SW8 to its default settings as shown in Figure 2.2.1 and Table 2.2.1.

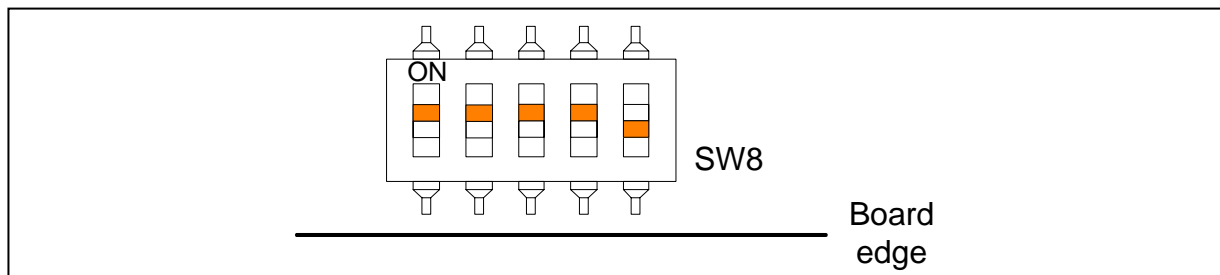

Figure 2.2.1 DIP Switch Setting

Table 2.2.1 Switch SW8 Functions

Switch No.	Function	Initial Settings	Setting
SW8-1	Set clock mode to 0	ON	Clock mode 0
SW8-2	Set clock mode to 1	ON	
SW8-3	HIF pin enable	ON	Cancel HIF pin activation
SW8-4	HIF boot mode specified	ON	Do not activate from host interface (HIF)
SW8-5	NOR flash memory	OFF	Cancel write protection in NOR flash memory

2.2.2 SH7670 CPU Board Jumper Switch Setting

To use the SH7670 CPU board following the installation described here, be sure to set the jumpers to their default settings as shown in Figure 2.2.2 and Table 2.2.2.

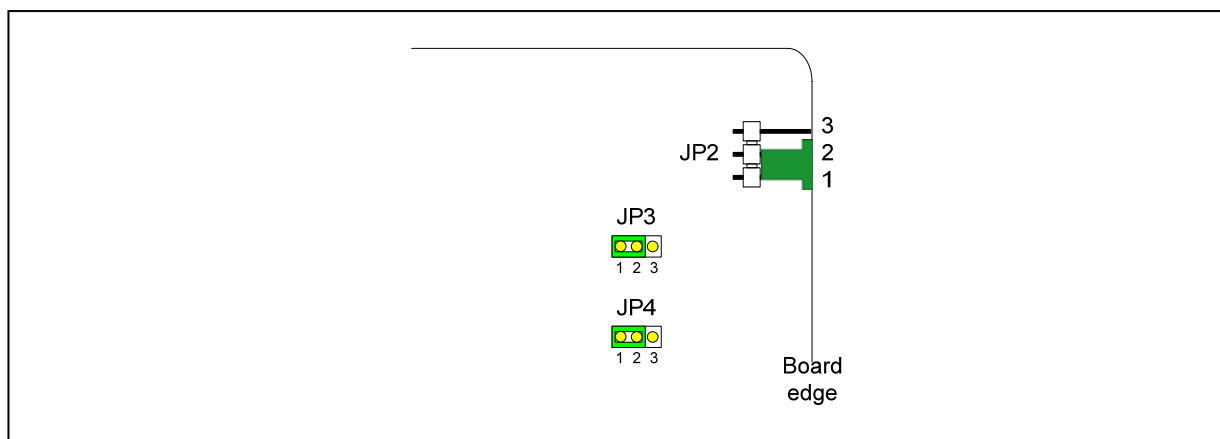

Figure 2.2.2 System Connection of SH7670 CPU board and E10A-USB Emulator

Table 2.2.2 SH7670 Group Power Supply Selection Jumper Setting (JP2 to JP4)

Jumper	Default Setting	Function
JP2	1-2	Power supply from J15
JP3	1-2	3.3 V fixed power supply voltage (supplied from U10)
JP4	1-2	1.2 V fixed power supply voltage (supplied from U11)

2.3 System Connections and Power-On Sequence

Follow the same procedure when you check to see that the power for the host computer is turned off, or that the E10A-USB emulator is not connected to the host computer with USB cable.

1. Connect the SH7670 CPU board and the E10A-USB emulator with the user interface cable.
2. Plug the USB cable into the connector on the host side of the E10A-USB emulator.
3. Turn on the power for the host computer. (The OS will start up.)
4. Supply power to the SH7670 CPU board (by turning the POWER switch on).

2.4 Procedure for Disconnecting System Power Supply

Disconnect power supply as following procedure.

1. Disconnect E10A-USB on HEW (High-performance Embedded Workshop).
2. Turn off a CPU board.
3. Terminate a HEW, and turn off a host computer.



- Unless the above power-on sequence is followed, unrecoverable damage may occur to the SH7670 CPU board or the E10A-USB emulator or both.

Chapter3
Setting Up the Software

3.1 About the HEW

HEW, or High-performance Embedded Workshop, is an integrated development environment with a graphical user interface designed to help users develop and debug the applications created in C/C++ and assembly languages for use in Renesas microcomputers. The SH7670 CPU board based software development is carried out by using the HEW. For more information about the HEW, refer to the “SuperH RISC Engine High-performance Embedded Workshop 4 User’s Manual”. The following shows how to install the HEW.

3.1.1 HEW Installation Procedure

- (1) Execute “HewInstMan.exe” included in the cross tool (SuperH RISC engine C/C++ compiler package) stored in the CD-ROM. High-performance Embedded Workshop Install Manager is activated, and click “Installation”.

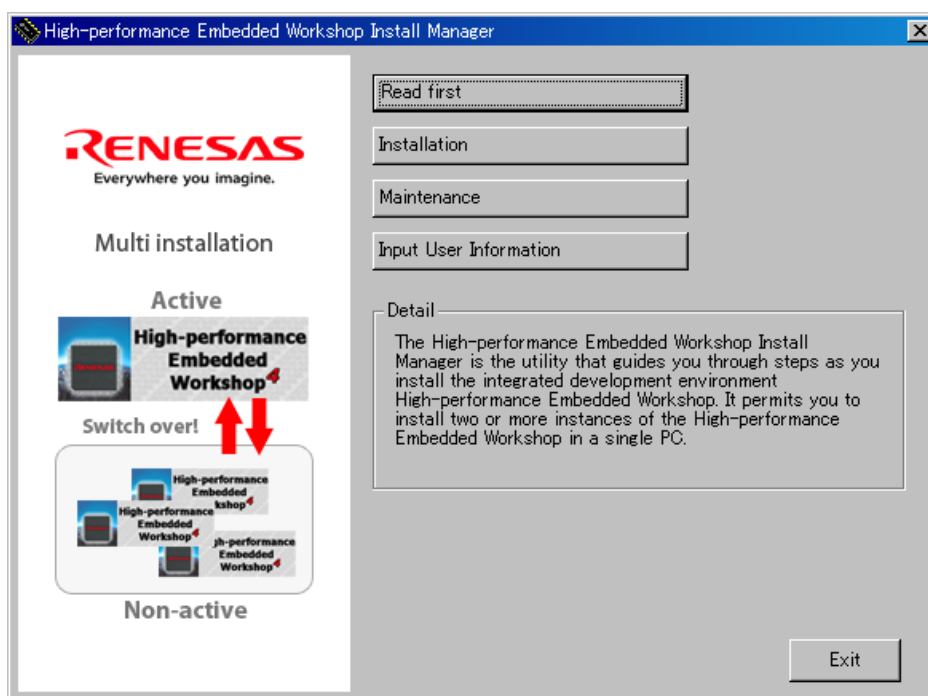

Figure 3.1.1 HEW Installation Procedure (1)

(2) Figure 3.1.2 is displayed, and click “Next”.

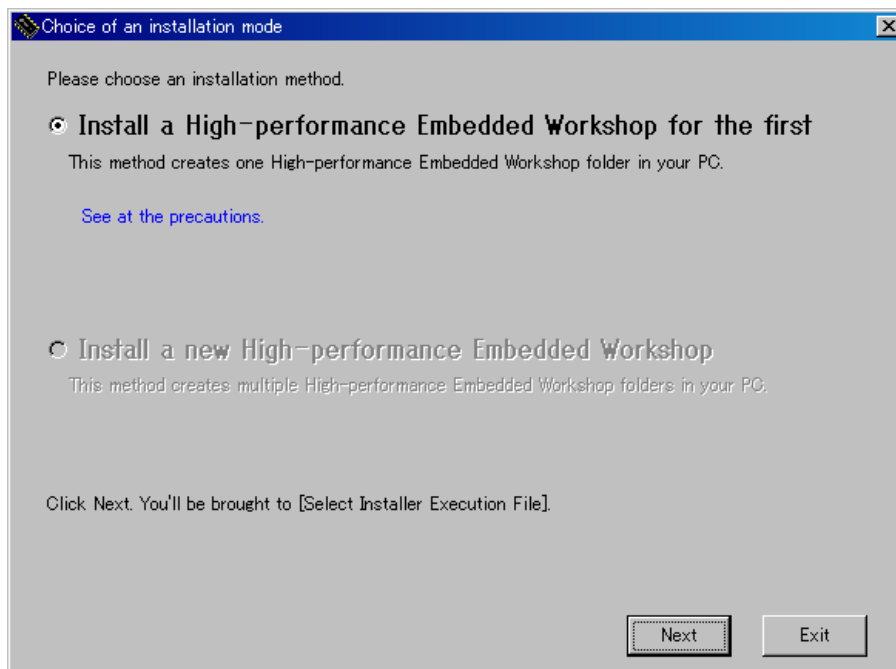

Figure 3.1.2 HEW Installation Procedure (2)

Note: If you have already installed a HEW on your PC, you can select “Install a new High-performance Embedded Workshop” and install a new HEW in another directory on your PC.

(3) Continue to install following the instructions in the installation window.

(4) Next, install an Autoupdate Utility. Click “Next”.

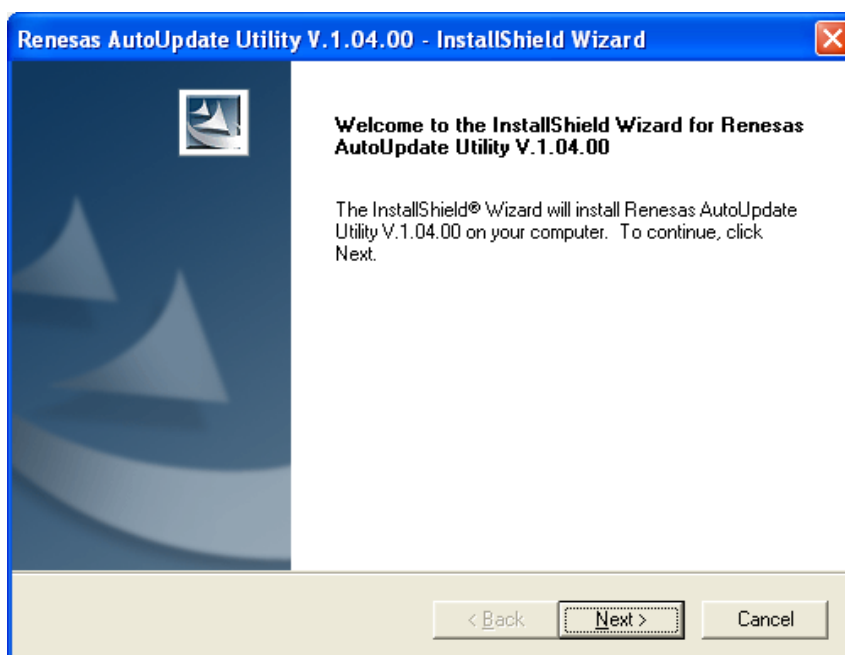

Figure 3.1.3 HEW Installation Procedure (4)

Note: When you have not selected “Autoupdate” on the Choice of an installation product, the above dialog is not displayed.

(5) Continue to install following the instructions in the installation window. When entire installation is finished, the dialog shown in Figure 3.1.4 is displayed, click "Exit".

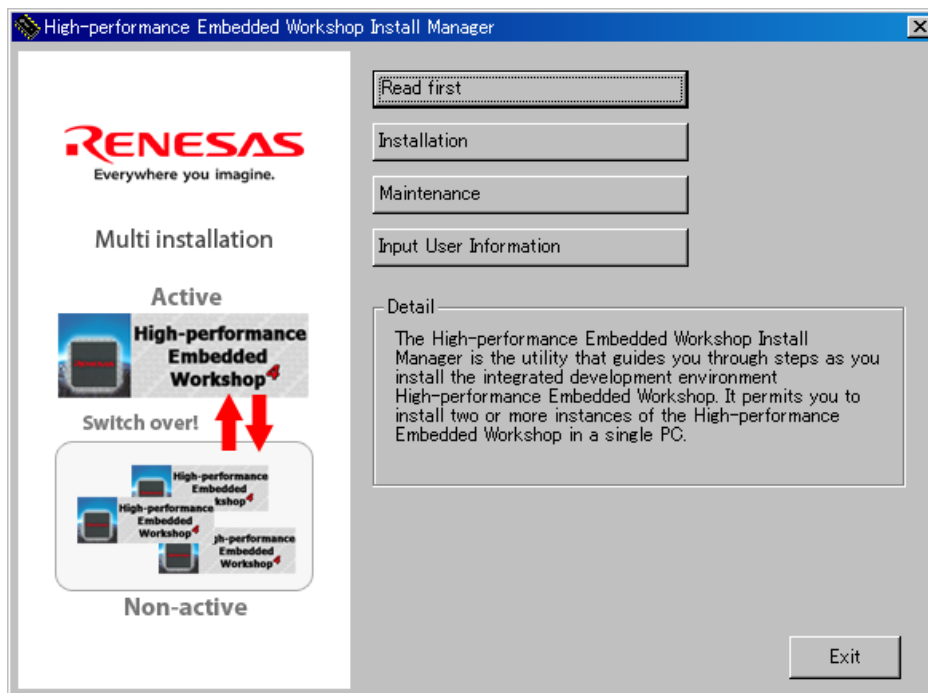

Figure 3.1.4 HEW Installation Procedure (5)

3.2 Setting Up the E10A-USB Emulator Software

Next, the following explains how to set up the E10A-USB emulator software.

3.2.1 E10A-USB Software Installation Procedure

- (1) Execute "HewInstMan.exe" included in the E10A-USB emulator software CD-ROM. High-performance Embedded Workshop Install Manager is activated, and click "Installation".

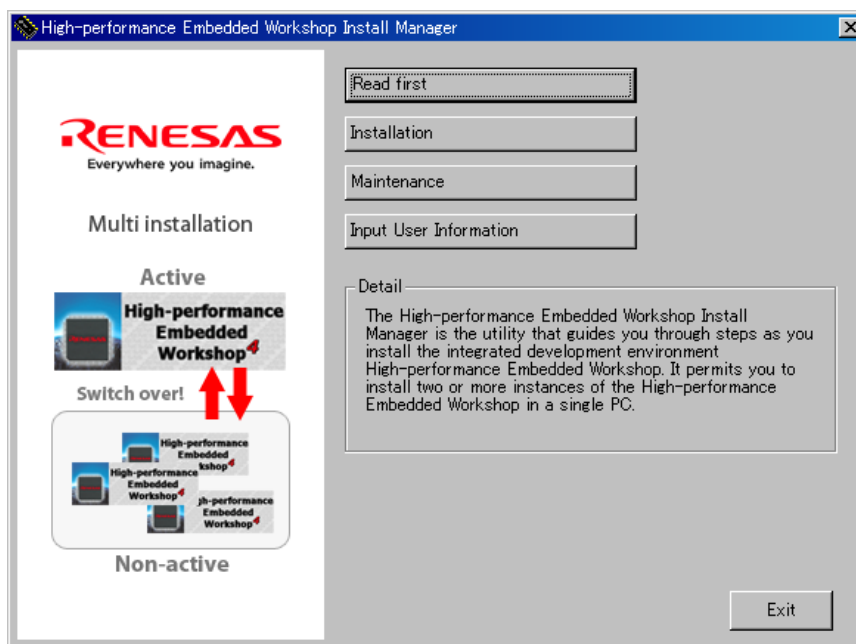

Figure 3.2.1 E10A-USB Software Installation Procedure (3)

- (2) When the dialog box shown in Figure 3.2.2 is displayed, select "Update the active High-performance Embedded Workshop" and click "Next".

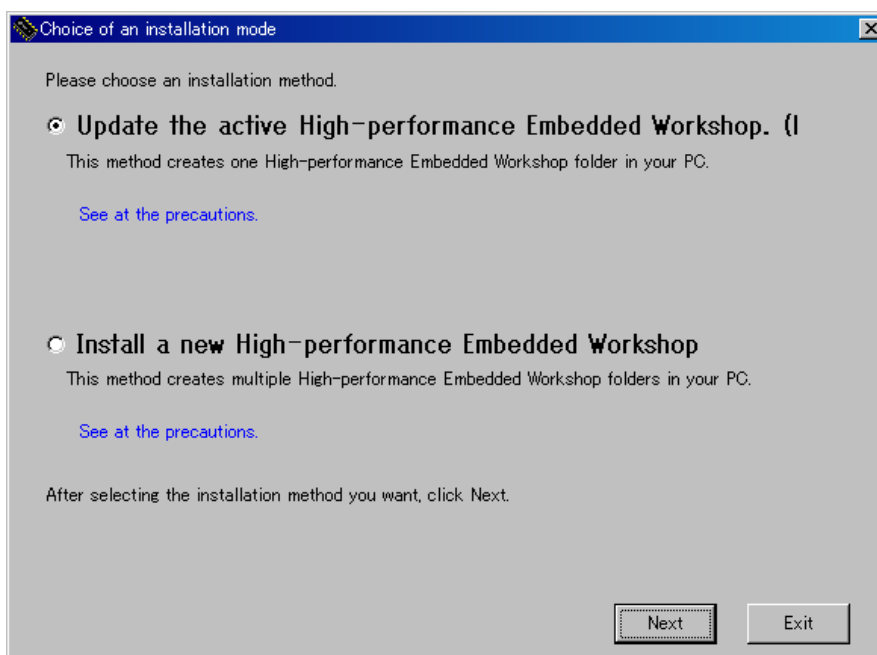

Figure 3.2.2 E10A-USB Software Installation Procedure (2)

Note: If you have already installed a HEW on your PC, you can select “Install a new High-performance Embedded Workshop” and install a new HEW in another directory on your PC.

- (3) When the dialog box shown in Figure 3.2.3 is displayed, select “SuperH RISC engine Family SH-2A Device Group” and “SH7670”, then click “Next”.

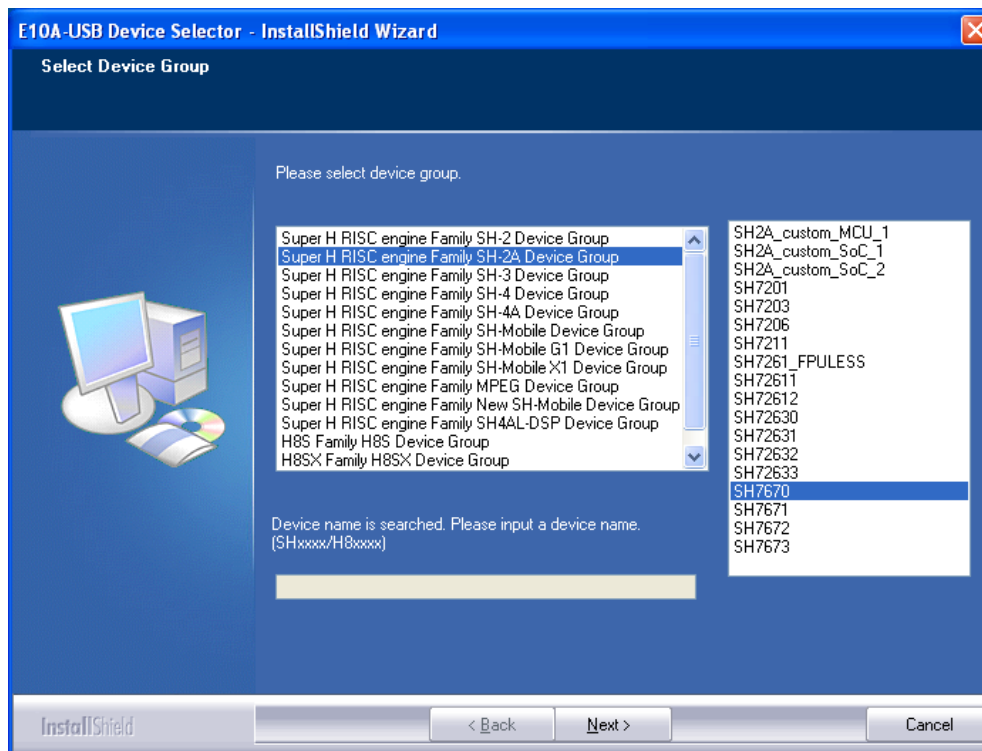

Figure 3.2.3 E10A-USB Software Installation Procedure (3)

- (4) Click “Next to start the installation. Continue to install following the instructions in the installation window.

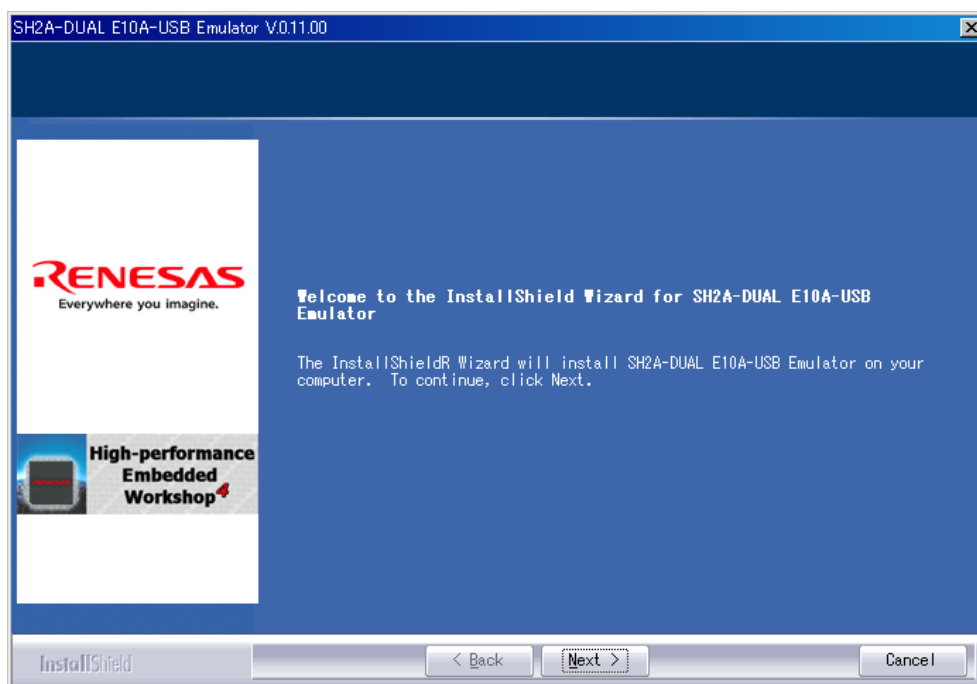

Figure 3.2.4 E10A-USB Software Installation Procedure (4)

(5) Next, install an Autoupdate Utility. Click “Next”.

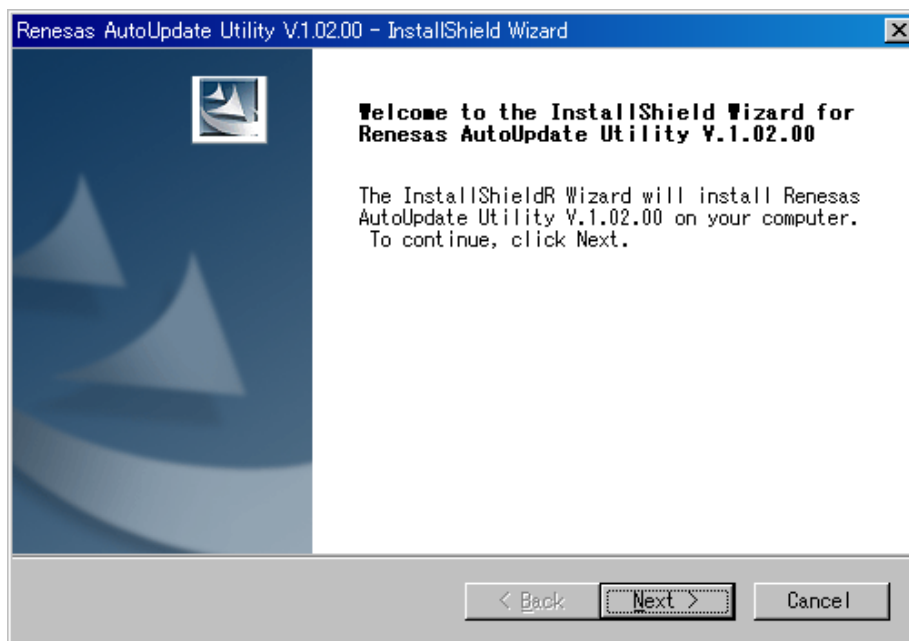

Figure 3.2.5 E10A-USB Software Installation Procedure (5)

Note: When you have not selected “Autoupdate” on the Choice of an installation product, the above dialog is not displayed.

(6) When the installation is complete, the dialog shown in Figure 3.2.6 is displayed. Click “Finish”.

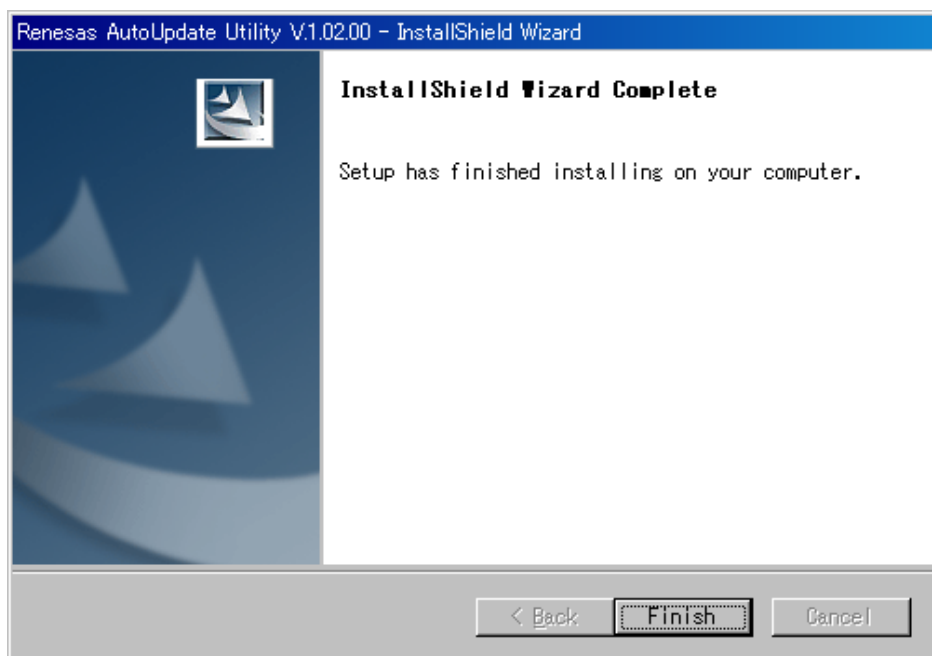

Figure 3.2.6 E10A-USB Software Installation Procedure (6)

(7) When entire installation is finished, the dialog shown in Figure 3.2.7 is displayed, click "Exit".

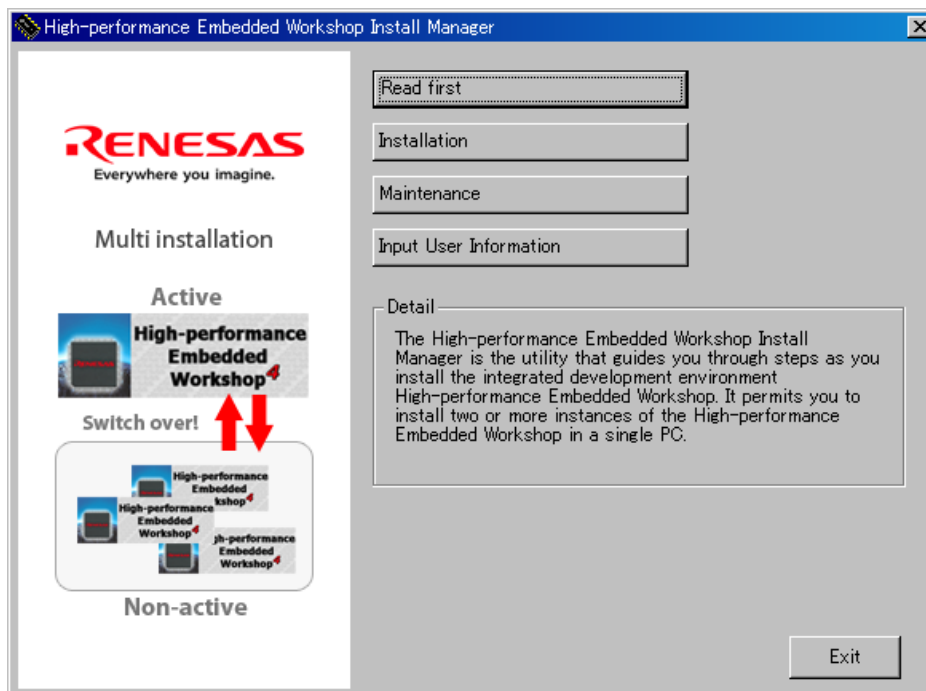

Figure 3.2.7 E10A-USB Software Installation Procedure (7)

3.2.2 Setting Up the E10A-USB Emulator

(i) Setting Up New Firmware

The following explains the case where you set up new firmware of the E10A-USB emulator.

If your E10A-USB emulator already has the firmware suitable for the SH-2A group, skip this step and go to paragraph (ii) "Setting Up the E10A-USB Emulator Driver."

Firmware setup requires changing the DIP switch settings on the E10A-USB emulator main unit. Be careful not to mistake the part of the DIP switch that you need to set. Figure 3.2.8 shows the DIP switch mounted on the E10A-USB emulator.

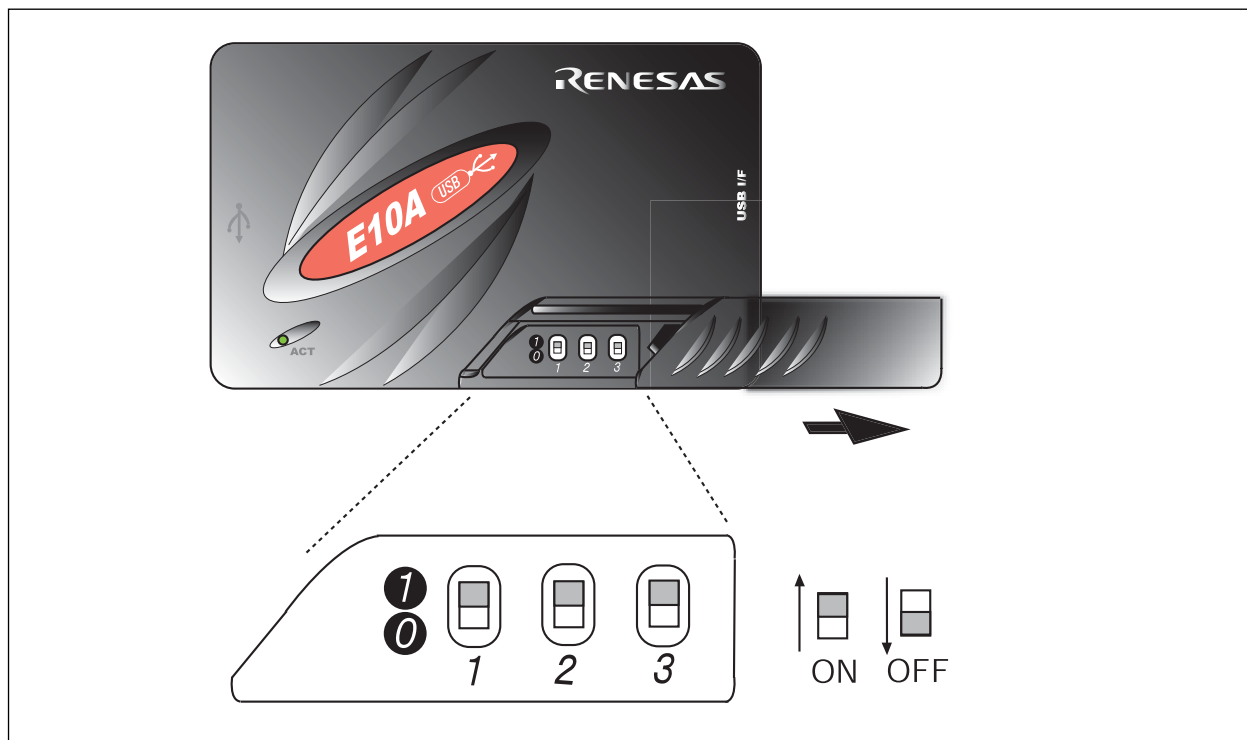

Figure 3.2.8 DIP Switch on the E10A-USB Emulator

- (1) Open the slide switch cover on the E10A-USB emulator main unit, and check to see that the emulator setup switch (SW1) is set to the “1” side.
- (2) From [All Programs] on [Start menu], choose [Renesas High-performance Embedded Workshop] → [Setup Tool for E10A-USB Emulator] → [SH-2A Device Group]. An E10A-USB emulator setup tool will start up.

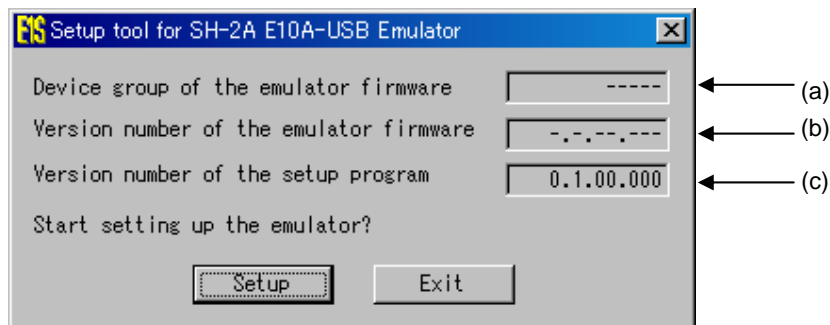

Figure3.2.9 E10A-USB Emulator Setup Tool

- (a) Device group of the emulator firmware : Shows the product group name that is currently set up.
- (b) Version number of the emulator firmware : Shows the version of the SH-2A group control software in the E10A-USB emulator.
- (c) Version number of the setup program : Shows the version of the setup program.

Note: The version numbers differ with each device group supported by the E10A-USB emulator.

Notes

- If the versions shown in (b) and (c) are the same, you do not need to set up. If the version shown in (b) is “-.-.-.-” or older than the version in (c), you need to set up.
- If the emulator connected to your system is not the E10A-USB emulator suitable for the SH7670, the error message shown below will be displayed, with the setup tool thereby terminated. In this case, you need to purchase an “additional device group license tool” separately from the SH7670 CPU board package and use it to set up the emulator firmware.

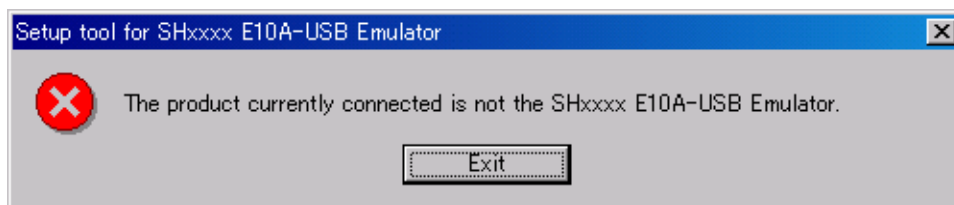

Figure3.2.10 Error Message

- If the error message shown below is displayed, it means that the host computer and the E10A-USB emulator are not connected together, or the emulator setup switch (SW1) is set to the “0” side. If the emulator setup switch (SW1) is set to the “0” side, set it to the “1” side and temporarily remove the USB cable and plug it in back again. If the Add New Hardware Wizard is displayed, refer to the next paragraph (ii), “Setting up the E10A-USB emulator driver.”

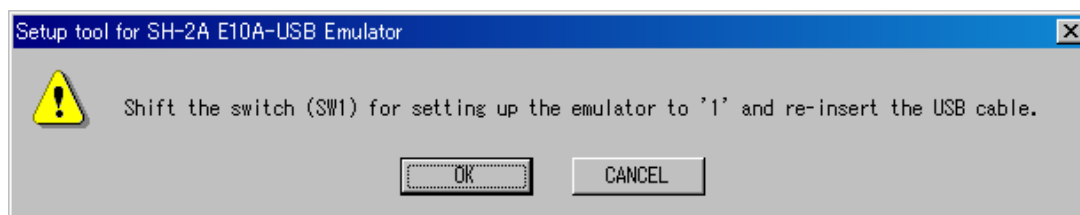

Figure3.2.11 Error Message

(3) Press "Setup"(Figure3.2.9). The dialog box shown below will be displayed.

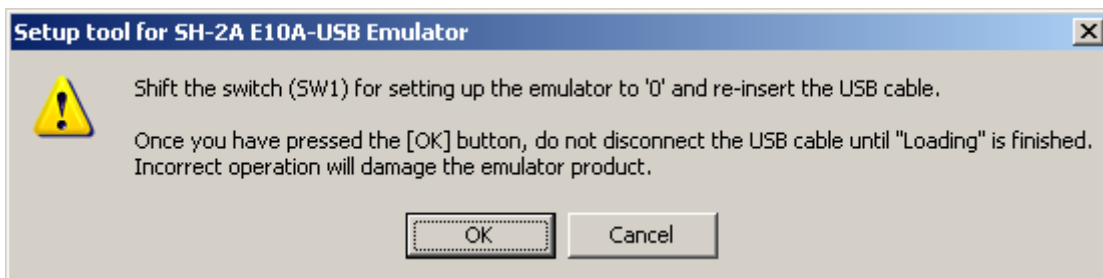

Figure3.2.12 Setup Tool for SHxxxx E10A-USB Emulator Dialog Box

(4) Set the emulator setup switch (SW1) to the "0" side, and temporarily remove the USB cable and plug it in back again. Then click "OK". The system will start setting up the E10A-USB emulator firmware.

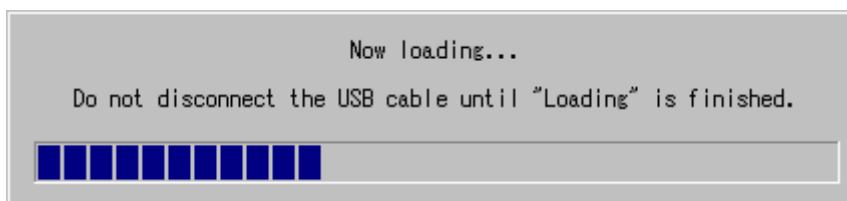
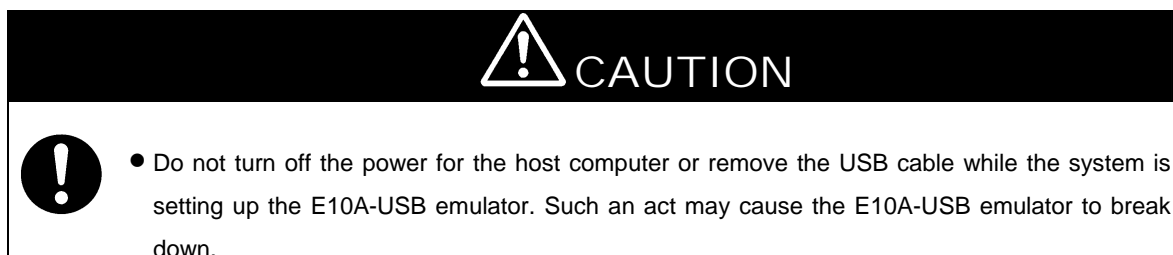

Figure3.2.13 System Starts Setting Up the Firmware



(5) When the dialog box shown below is displayed, it means that the system has finished setting up the E10A-USB emulator normally.



Figure3.2.14 Setup Completion Message

- (6) After the E10A-USB emulator setup is completed, the message shown below will be displayed.
Set the emulator setup switch (SW1) to the "1" side, and temporarily remove the USB cable and plug it in back again.
Then click "OK".

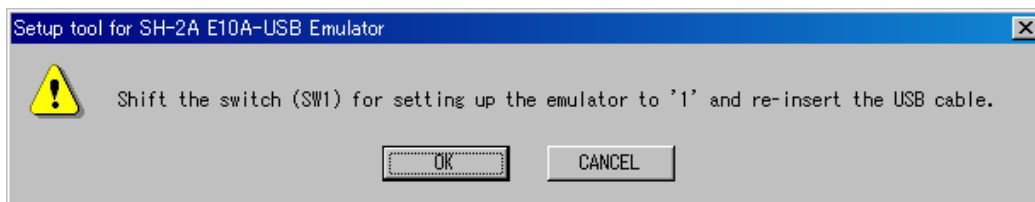

Figure3.2.15 Setup Tool for SH-2A E10A-USB Emulator Dialog Box

Note: Always make sure the emulator setup switch (SW1) remains in the "1" side unless the setup tool is used.

- (7) The dialog box shown below will be displayed again, so check it to see that you now have the latest version of firmware installed, and click "Exit". Then you've finished setting up new firmware.

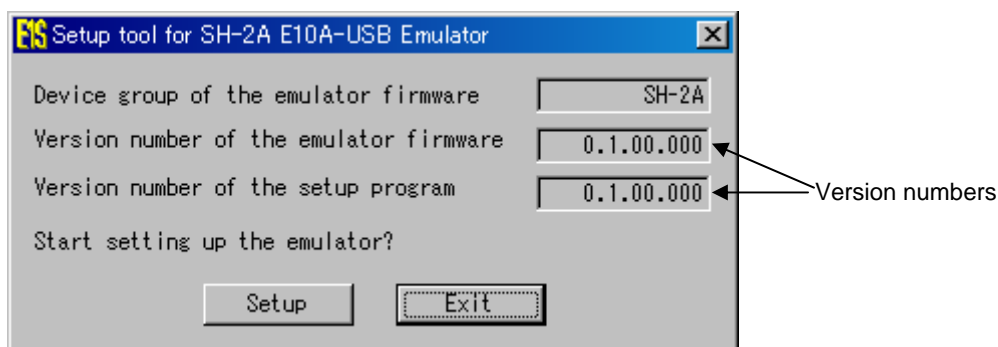

Figure3.2.16 E10A-USB Emulator Setup Tool at Completion

Note: The version numbers differ with each device group supported by the E10A-USB emulator.

(ii) Setting Up the E10A-USB Emulator Driver

The following shows how to set up the E10A-USB emulator driver.
The setup procedure here is explained for the Windows XP case.

Note: The dialog boxes shown here are displayed when you set up the E10A-USB emulator driver for the first time or when you've changed the USB port on the host computer side and connected the emulator to that port for the first time. It will take some time until the dialog box appears.

(1) [Found New Hardware Wizard] shown below will start.

In this dialog box, select the option "Install from the list or specific location (Advanced)", then click "Next".

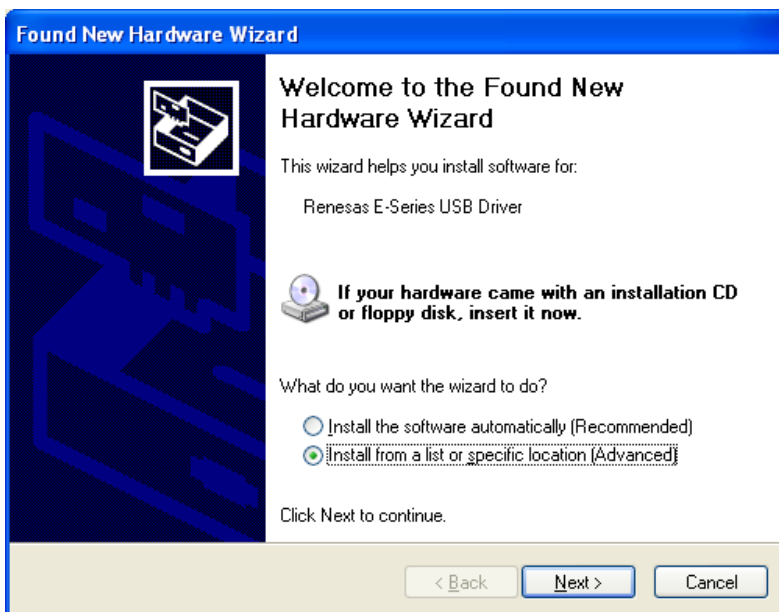

Figure3.2.17 New Hardware Detection Wizard Start (1)

(2) Select the option "Search for the best driver in these locations" and select the check box "Search removable media (floppy, CD-ROM...)." Then click "Next".

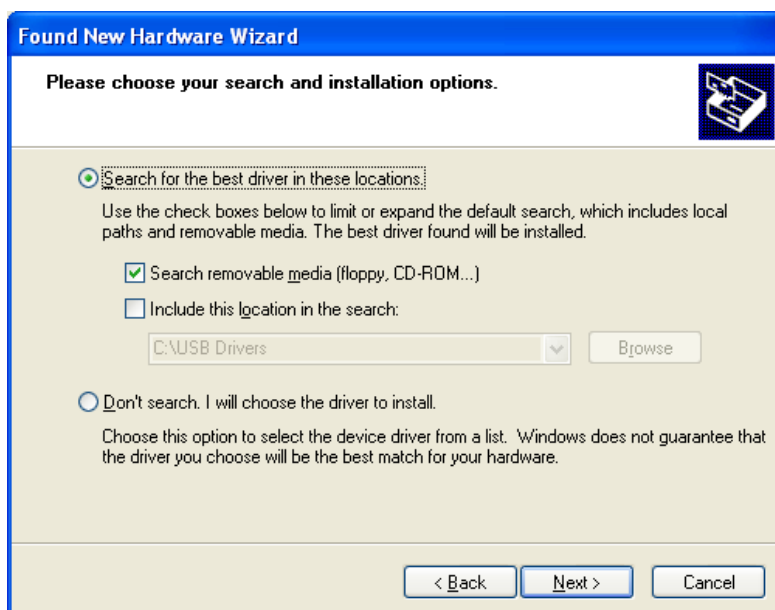

Figure3.2.18 New Hardware Detection Wizard Start (2)

- (3) Search the CD-ROM for drivers and select” <drive>:\driver\usb\xp\elusb.inf“ and then click “Next”. The ‘xp’ in the underlined part (in the setup here, Windows XP) indicates the OS version.

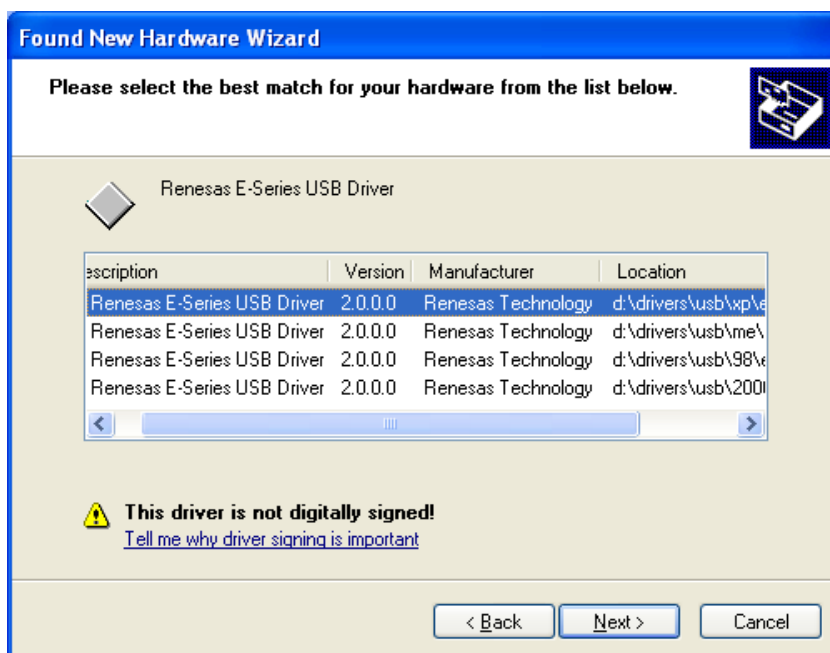

Figure3.2.19 New Hardware Detection Wizard Start (3)

Note: If [Hardware installation] dialog box, which says the software has not passed Windows Logo.. is displayed, just click “Continue Anyway”. The version numbers differ with each device group supported by the E10A-USB emulator.

- (4) [Found New Hardware Wizard] dialog box shown below will be displayed. Click “Finish”. You’ve now finished setting up the E10A-USB emulator driver.



Figure3.2.20 Finish New Hardware Detection Wizard Dialog Box

(5) Activate Device Manager to confirm whether the USB controller driver has been installed.

<Activating Device Manager>

Choose [Control Panel] from [Start menu] and double-click [System] icon. In [System Properties] dialog box, click the [Hardware] tab and then [Device Manager].

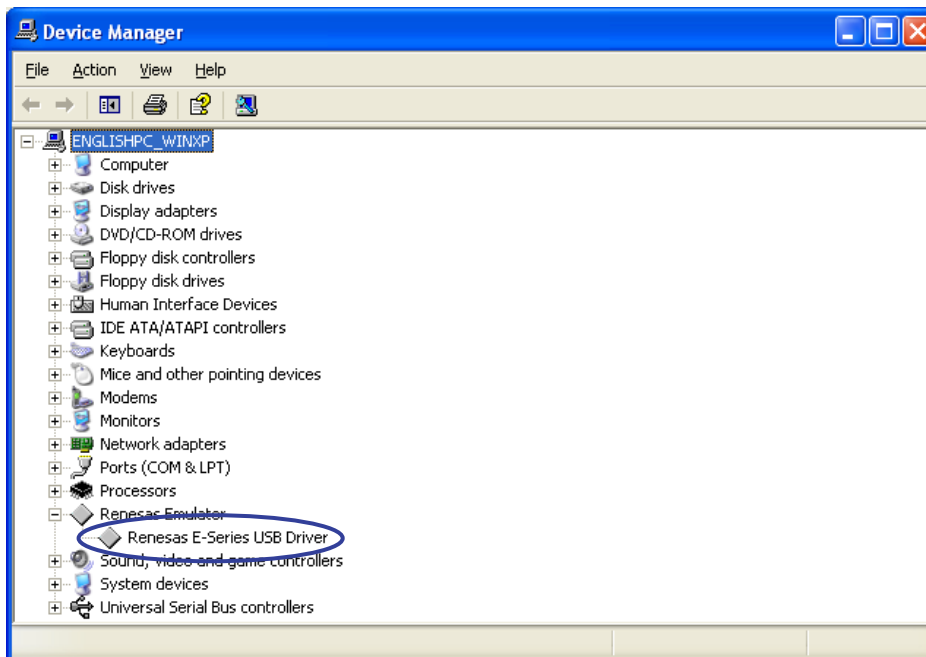

Figure3.2.21 Confirming in the Device Manager Window

This page is blank

Chapter4
Running the Software

4.1 Running the Software

This product comes with sample software for verifying the hardware operation as technical reference material for software development. The following describes the necessary steps to be followed before the load module of the sample software can be downloaded.

Note: To execute the sample software, the DIP switch (SW8) on the SH7670 CPU board should be set as the initial setting.

4.1.1 Preparing for Downloading the Sample Software

Copy "Sample_software" directory from the CD-ROM into the working directory of the host computer. When the "Sample_software" directory has the read-only attribute, remove its read-only attribute. Make sure the directory path to which this directory is copied does not include kanji and space characters. Presence of such characters makes the cross tools unable to operate normally.

The explanation below assumes that this directory has been copied to the C:\WorkSpace directory.

Notes:

- To download the load module of the sample software, the HEW and E10A-USB emulator software must be installed in your host computer. (Refer to chapter 3)
- When you desire to modify the sample software, the SuperH RISC engine C/C++ compiler package must be installed in your host computer. (Refer to the section 1.5 Items to Be Prepared by User)

4.1.2 SH7670 CPU board and E10A-USB Startup Procedure (HEW Startup)

- (1) Connect the host computer and the E10A-USB emulator.
- (2) Connect the SH7670 CPU board and the E10A-USB emulator. (Do not turn on the power for the SH7670 CPU board yet.)
- (3) From [All Programs] on [Start menu], choose [Renesas High-performance Embedded Workshop] → [High-performance Embedded Workshop].
- (4) [Welcome] dialog box shown below will be displayed.
Select the option "Browse to another project workspace" and click "OK".

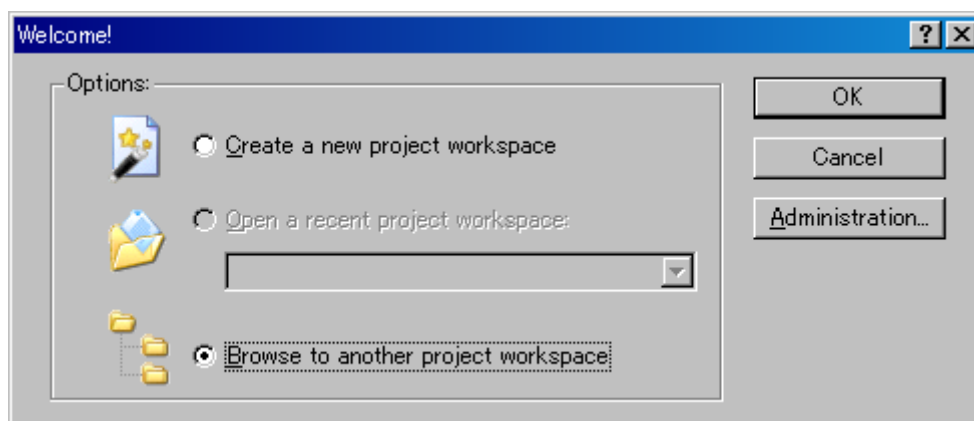

Figure 4.1.1 Welcome Dialog Box

Note: The project workspace is a user's working area, in which projects and their configurations are accommodated. A project consists of a configuration necessary to create programs or final binary files and a set of files. For more information about the project workspace, refer to the "SuperH RISC engine High-performance Embedded Workshop 4 User's Manual."

(5) The [Open Workspace] dialog box shown below is displayed. In this dialog box, specify the directory indicated below.

<Directory in which to store the sample software>

"C:¥WorkSpace¥Sample_software¥SH7670_sample"

(6) After specifying the directory, select the file indicated below and click "Select".

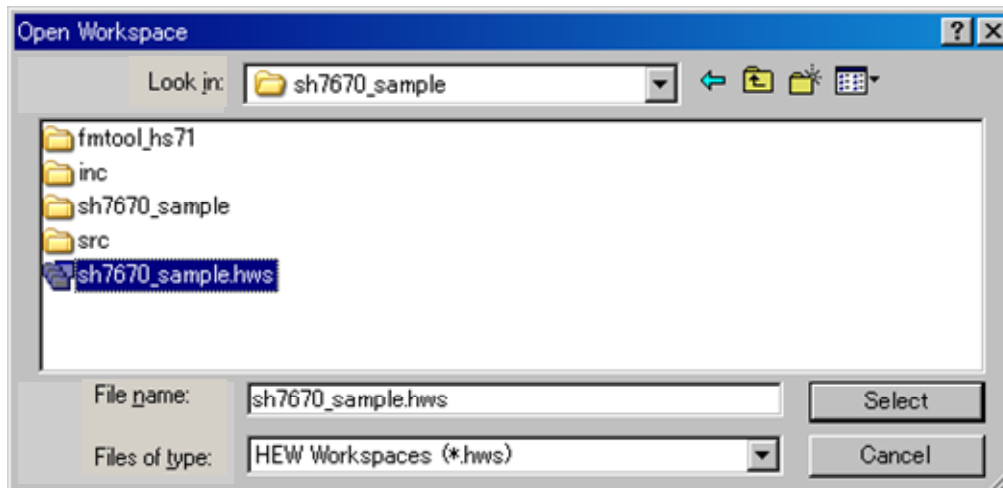

Figure 4.1.2 Open the Workspace Dialog Box

Note: For the first time only, a dialog box prompting you to confirm that the workspace directory has been moved will be displayed. When this dialog box appears, click "Yes".

(7) The [Select Emulator mode] dialog box shown below is displayed.

Select "Device:SH7670" and "E10A-USB Emulator" and click "OK".

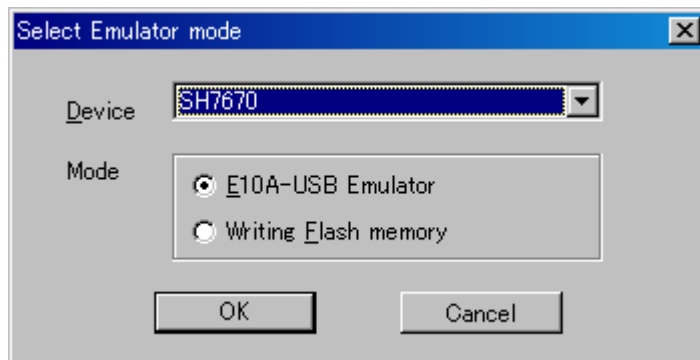

Figure 4.1.3 Select Emulator Mode Dialog Box

Note: For the first time only, a message “Please choose driver” is displayed. Click “OK” to display the Driver Details, and select “Renesas E-Series Driver” for the Driver.

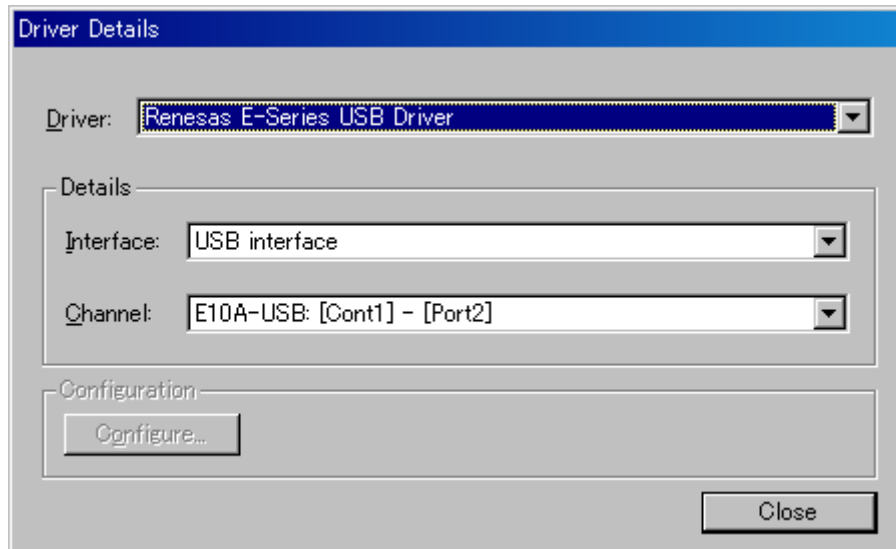

Figure 4.1.4 Driver Details Dialog Box

(8) [Connecting] dialog box is displayed, and the system starts connecting the emulator.



Figure 4.1.5 Connecting Dialog Box

(9) The dialog box shown below is displayed.

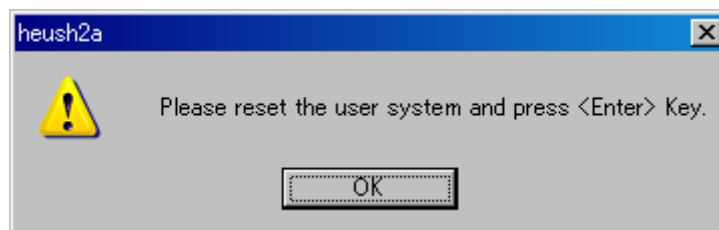

Figure 4.1.6 Dialog Box Prompting to Reset the User System

- (10) Turn on the power for the SH7670 CPU board.
- (11) Press the reset button (SW3) on the SH7670 CPU board and press “OK” in the above dialog box.
- (12) If the reset signal cannot be detected, the dialog box shown below is displayed.

Clicking “Ignore” here allows you to issue an internal reset from the E10A-USB emulator to the CPU and thereby start up the system.

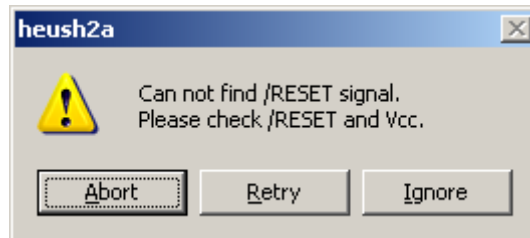

Figure 4.1.7 Cannot Find RESET Signal Dialog Box

- (13) When you see “Connected” displayed in [Output] window of the HEW, it means that the E10A-USB emulator has started up successfully.

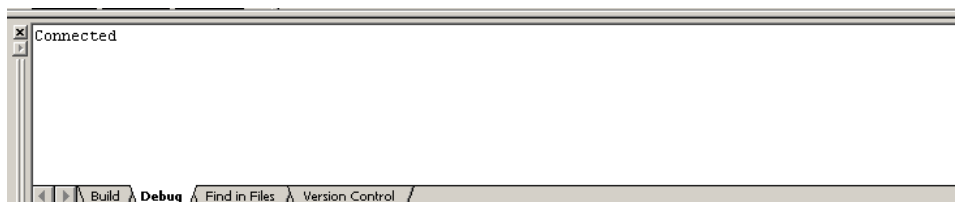

Figure 4.1.8 Output Window

4.1.3 E10A-USB Emulator Connection Error Dialog

If the E10A-USB emulator does not start up, the dialog box shown below will be displayed.

- (a) If the dialog box shown below is displayed and the E10A-USB emulator cannot be started by the method in (11) on the previous page, the SH7670 CPU board may not be supplied with the system power. Check the power supply for the SH7670 CPU board.

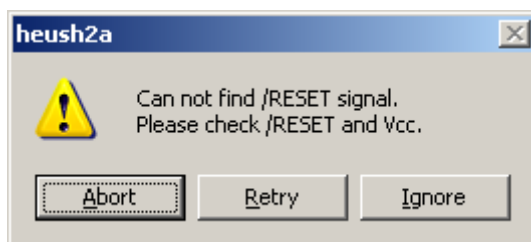

Figure 4.1.9 Can not find /RESET signal Dialog Box

- (b) If the dialog box shown below is displayed, the H-UDI pins and the H-UDI port connector may not be connected correctly. Check the connection between the H-UDI pins and the H-UDI port connector.

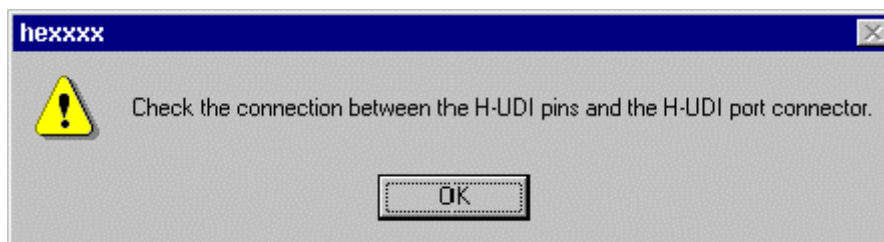

Figure 4.1.10 Check the Connection Dialog Box

- (c) If the dialog box shown below is displayed, the E10A-USB emulator firmware may not be set up correctly. Use the setup tool or the additional license tool to set up the firmware for the device group that you use.



Figure 4.1.11 Product Currently Connected Dialog Box

- (d) If the dialog box shown below is displayed, the firmware version set up in the E10A-USB may be old. Use the setup tool to set up the appropriate version of firmware.

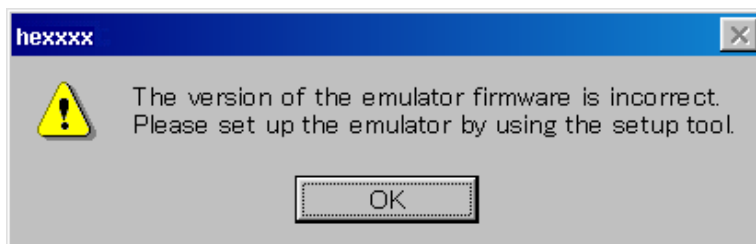

Figure 4.1.12 Version of the Emulator Firmware Dialog Box

(e) If the driver has not been set up correctly, the dialog box shown below will be displayed.

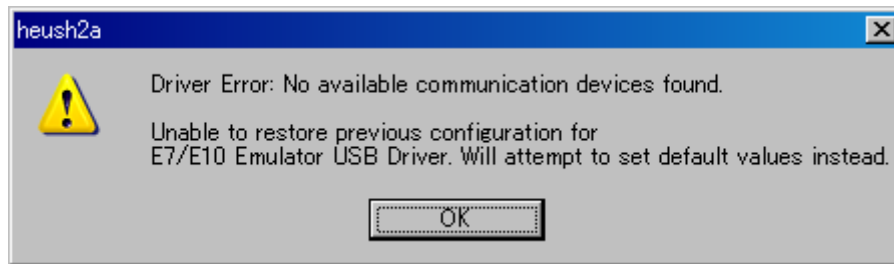

Figure 4.1.13 Unable to Restore Dialog Box

(f) If a wrong device is selected, the following dialog box is displayed.

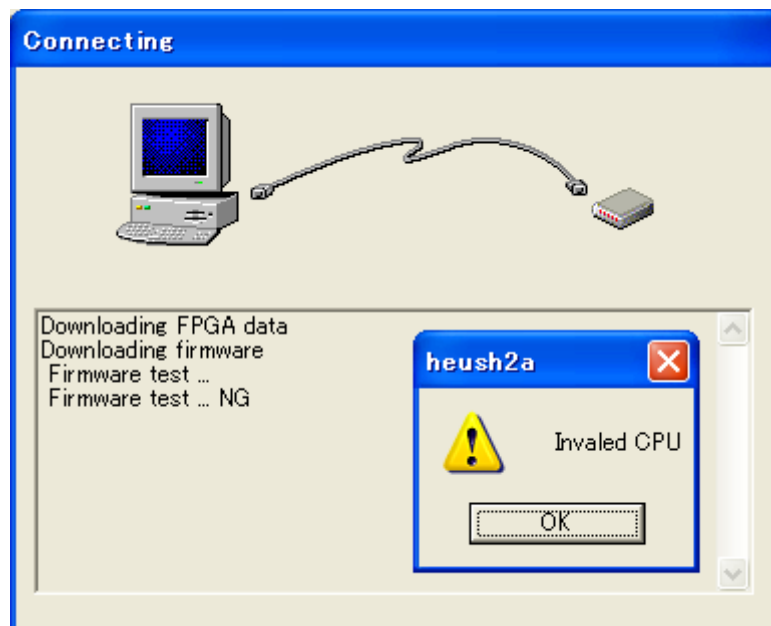

Figure 4.1.14 [Invalid CPU] Dialog Box

4.1.4 Sample Software Download Procedure

Next, the following describes how to download the load module of the sample software.

Here, the sample software is downloaded to the flash memory connected external to the SH7670 CPU board.

For details about flash memory download settings, refer to the "SuperH Family E10A-USB Emulator User's Manual."

(1) Setting up the flash memory download function

From [Setup] menu → [Emulator] → [System...], open [Configuration] dialog box and then [Loading flash memory] page.

For "File Name" here, specify the flash memory download program " fmtreeol_hs71.mot". The sample workspace is assumed to have the flash memory download program stored in the directory indicated below.

" C:¥Workspace¥Sample_software¥sh7670_sample¥fmtreeol_hs71"

As shown in Figure 4.1.15, select "Enable" for Loading Flash Memory, and after checking "File Name", "Bus Width of Flash Memory" and "Entry Point" settings, press "OK".

Note:

- "Loading Flash Memory" is set to "disable" in the default setting. Therefore, you need to enable it whenever you connect the E10A-USB emulator.
- In fmtreeol_hs71.mot, because the flash memory of each sector is deleted by using Writing module, please select "Disable" for Erasing flash memory.

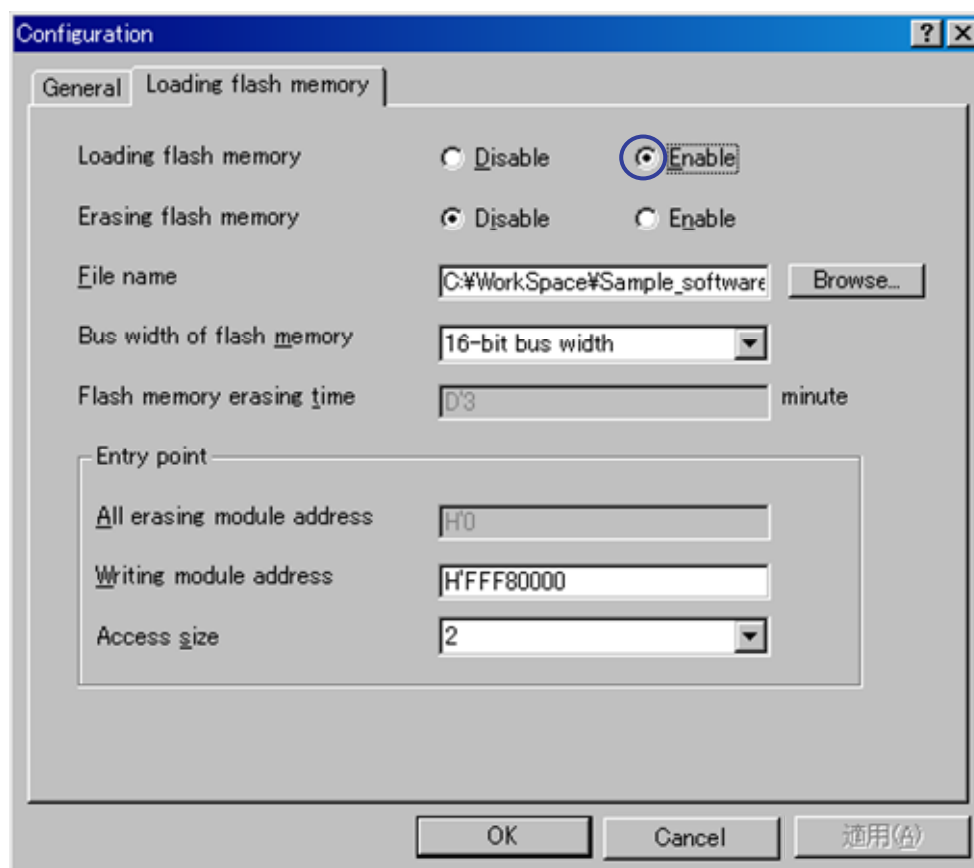

Figure 4.1.15 Configuration Dialog Box

(2) Specifying the command batch file before downloading

Next, you need to run the script file (fmttool_hs71.hdc) in which the access timing and bus control signal settings are written in the flash memory of the SH7670 CPU board before downloading the sample software.

In the sample workspace, the following script file is assumed to be stored in.

" C: \Workspace\Sample_software\SH7670_sample\ fmttool_hs71"

Open [Debug] menu → [Debug Settings], and select [Option] tab. Check to see that the items on this tab are set as shown below.

Command batch file load timing: Before download of modules

Command line batch processing:

"C: \Workspace\ Sample_software\sh7670_sample\fmttool_hs71\ fmttool_hs71.hdc"

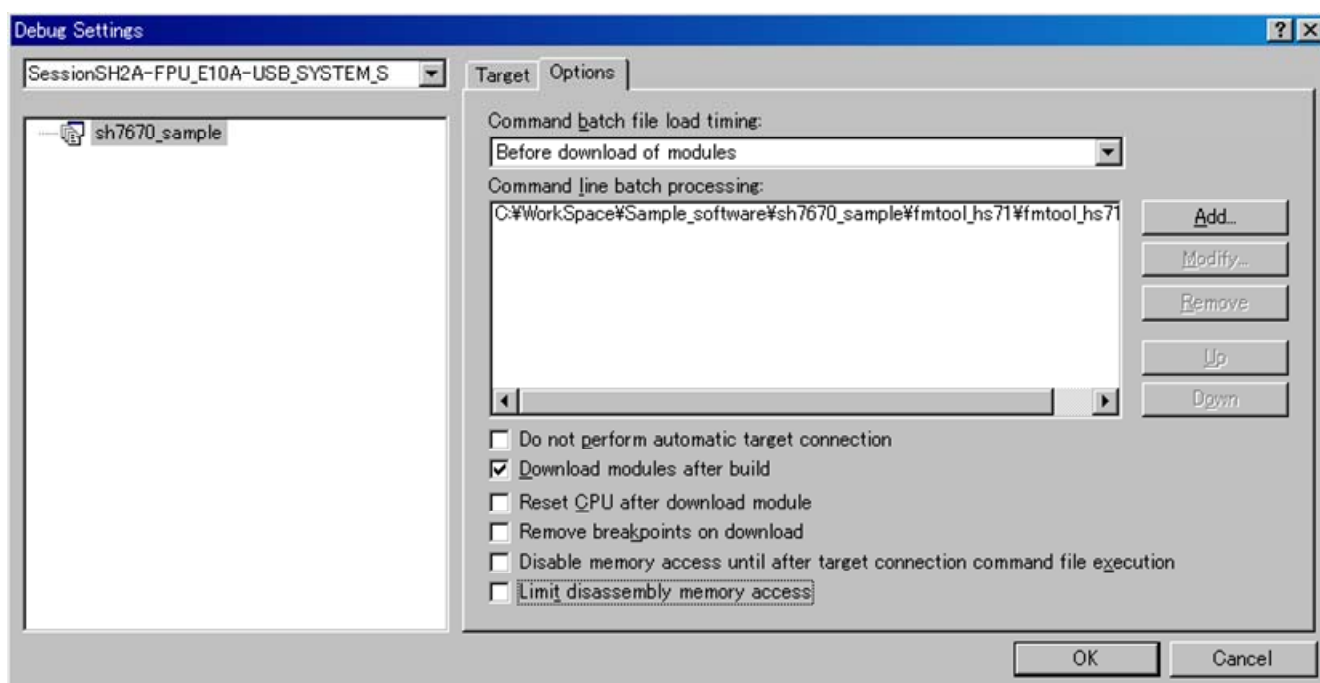

Figure4.1.16 Debug Settings Dialog Box

(3) Activating the command line window

When downloading the load module of the sample software, you need to activate [Command Line] window to check whether the script file is running.

Select [View] menu → [Command Line] to check whether [Command Line] window is open.

Note: Unless the script file is running, you cannot download the load module into the flash memory. So be sure to check this.

(4) Downloading the sample load module

Choose Download from the Debug menu and then sample load module. Figure 4.1.17 shows the download operation window.

Immediately after you select the sample load module, the script file is automatically executed. Then the system starts downloading the sample load module.

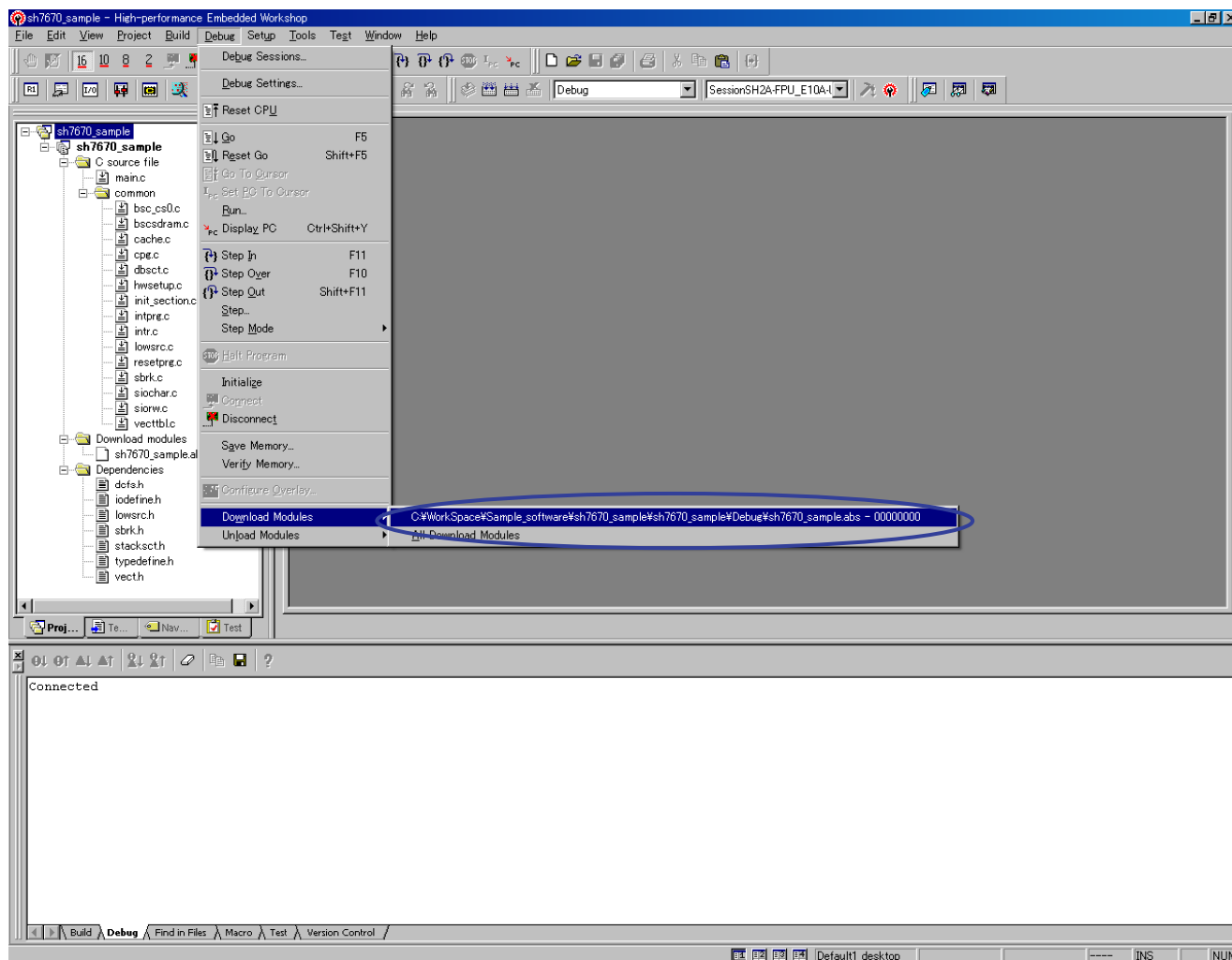

Figure 4.1.17 Download Operation Window

(5) Completion of downloading

When the system has finished downloading the sample load module, the program counter is shown in "resetprg.c".
(See Figure 4.1.18)

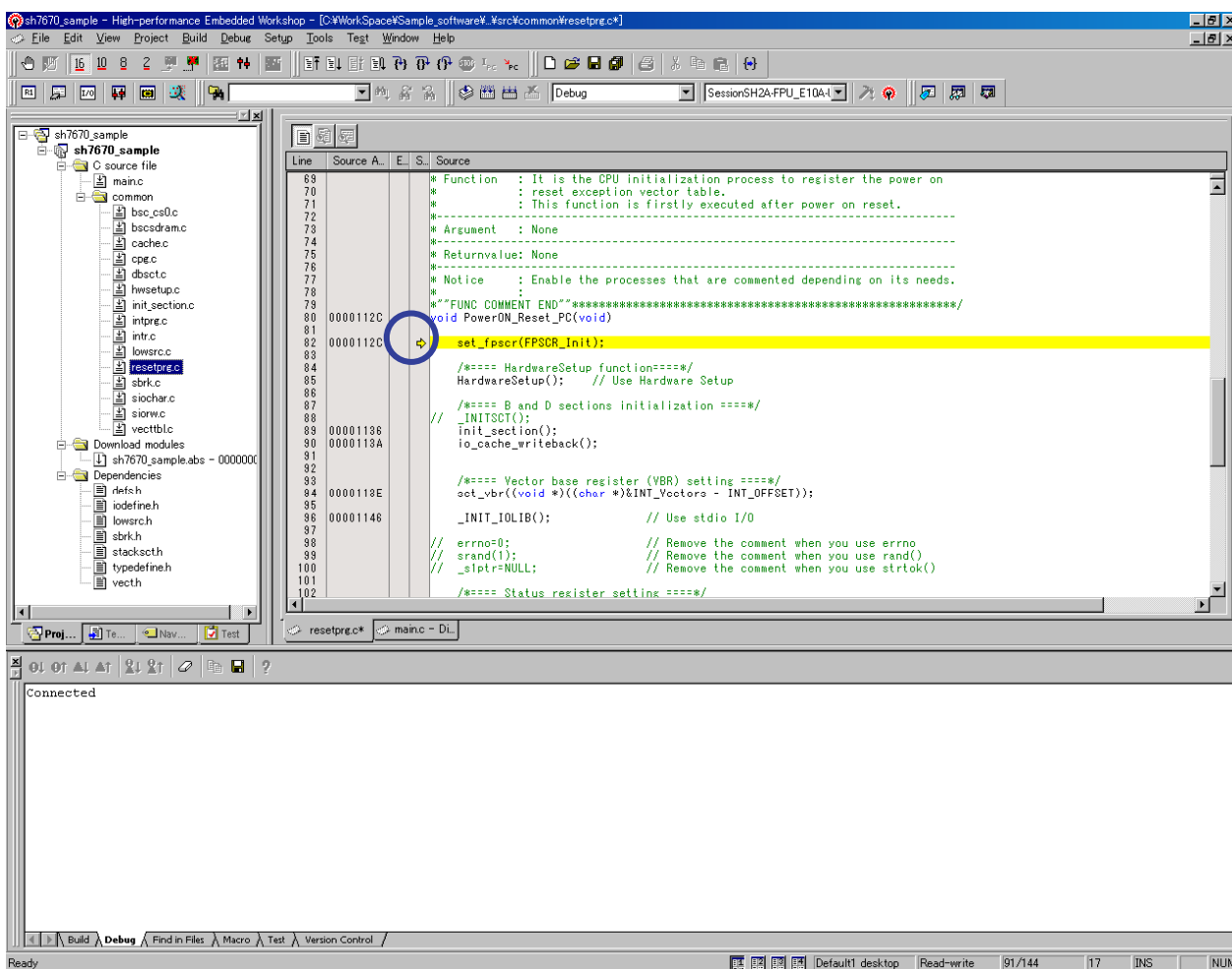

Figure 4.1.18 Download Completion Window

(6) Running the program

To execute the program, select “Go” from the Debug menu (See Figure 4.1.19).

If the sample software is downloaded normally, LED7 on the SH7670 CPU board lights up and goes out alternately at approximately one-second intervals.

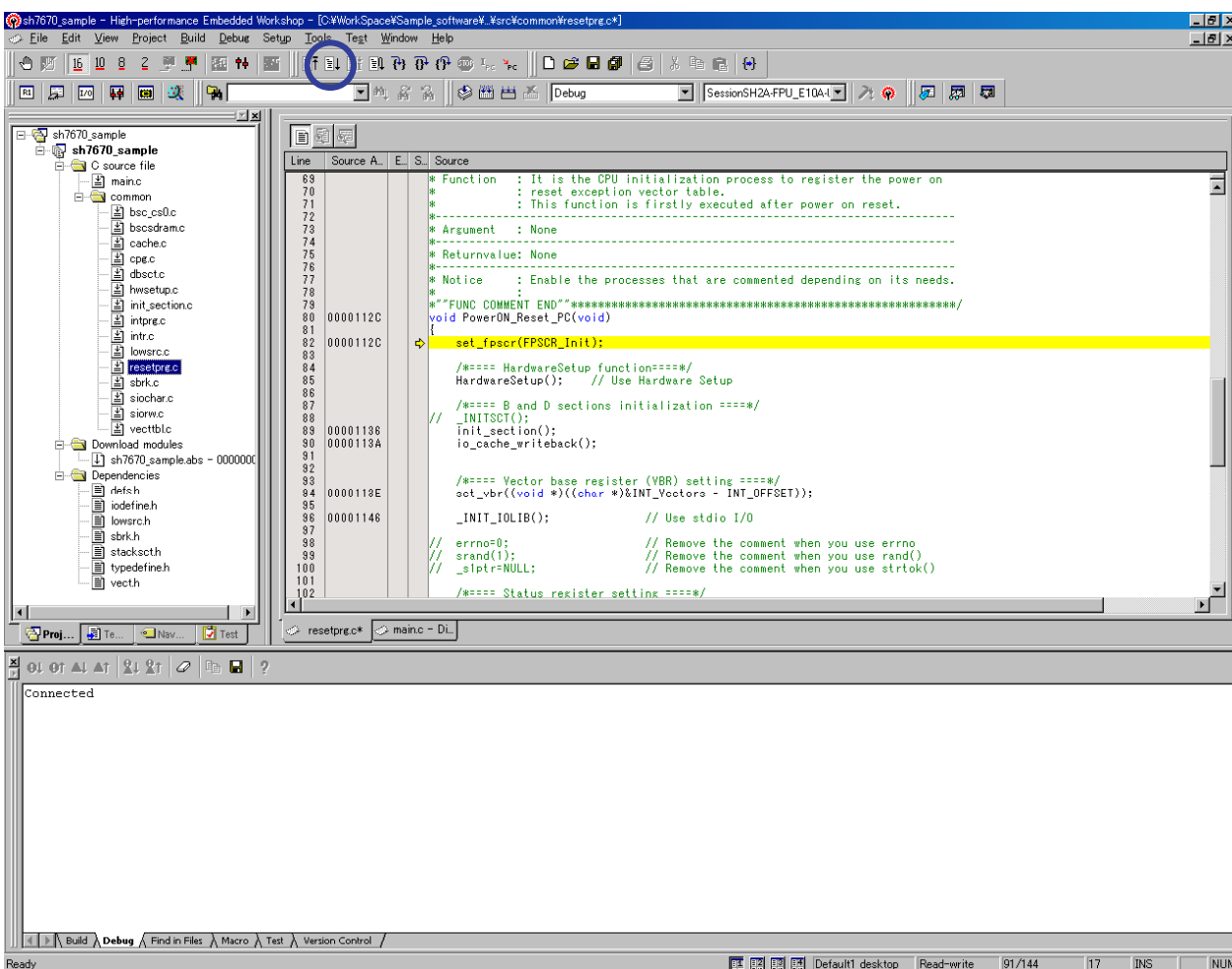

Figure 4.1.19 Running the Program

Note: The contents of “resetprg.c” can be different according to the sample software version. If an error occurs or unable to operate correctly or the software does not operate correctly, the hardware or software may not have been set up correctly. Check the setup procedures in Chapters 2 and 3.

Chapter5

Creating and Running a New Project Workspace

5.1 Creating a New Project Workspace

The following explanation describes how to create a new project workspace suitable for the SH7670 CPU board.

The procedure for creating a load module from a new project workspace and then downloading and running the module in the flash memory connected external to the SH7670 CPU board are described as the below.

5.1.1 Preparing for Creating a New Project Workspace

Copy "Sample_software" directory from the CD-ROM into the working directory of the host computer. When the "Sample_software" directory has the read-only attribute, remove its read-only attribute. Make sure the directory path to which this directory is copied does not include kanji and space characters. Presence of such characters makes the cross tools unable to operate normally.

The explanation below assumes that this directory has been copied to the "C:¥Workspace¥sample_software"

Note: To create a new project workspace, the HEW, E10A-USB emulator software, and SuperH RISC engine C/C++ compiler must be installed in the host computer.

5.1.2 Procedure for Creating a New Project Workspace

- (1) Connect the host computer and the E10A-USB emulator.
- (2) Connect the SH7670 CPU board and the E10A-USB emulator. (Do not turn on the power for the SH7670 CPU board yet.)
- (3) From [All Programs] on [Start] menu, choose [Renesas High-performance Embedded Workshop]
→ [High-performance Embedded Workshop].
- (4) [Welcome] dialog box shown below will be displayed.
- (5) In this dialog box, select the option "Create a New Project Workspace" and click "OK".

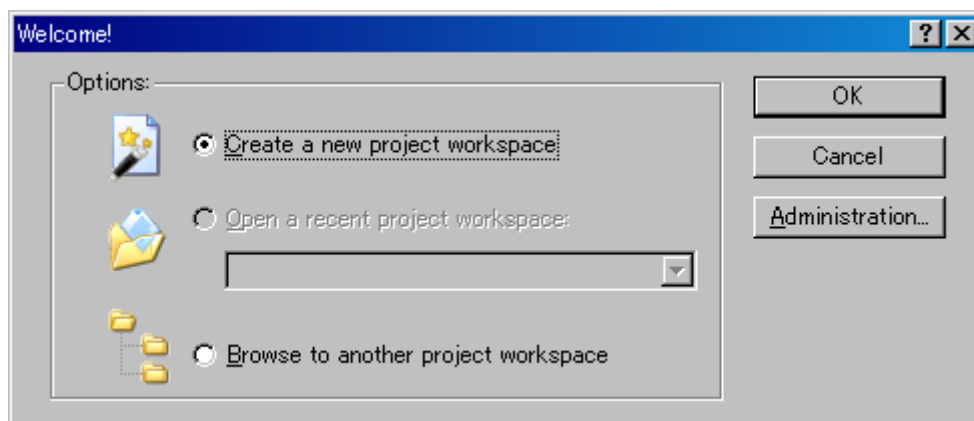

Figure 5.1.1 Welcome Dialog Box

(6) Project Generator will start.

Here, enter "test" for the workspace name. After checking the directory, CPU type and tool chain, click "OK".

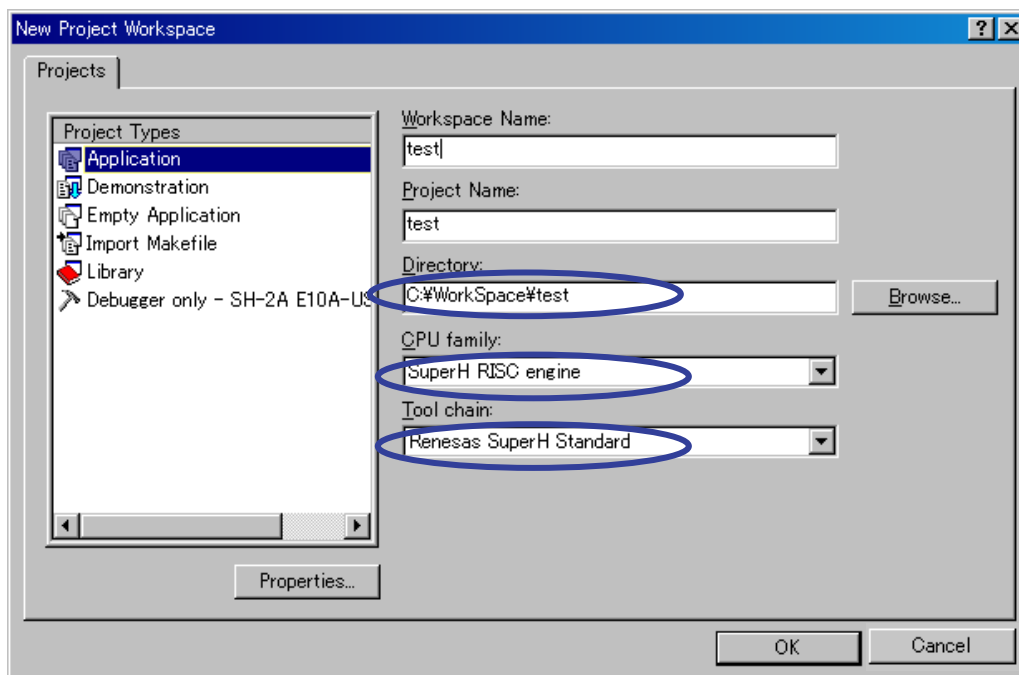

Figure 5.1.2 New Project Workspace Dialog Box

(7) Next, select a "CPU Series" and a "CPU Type" from [New Project-1/9-Select Target CPU] dialog box. Make selections as follows; CPU Series: SH-2A-FPU, CPU Type: Other

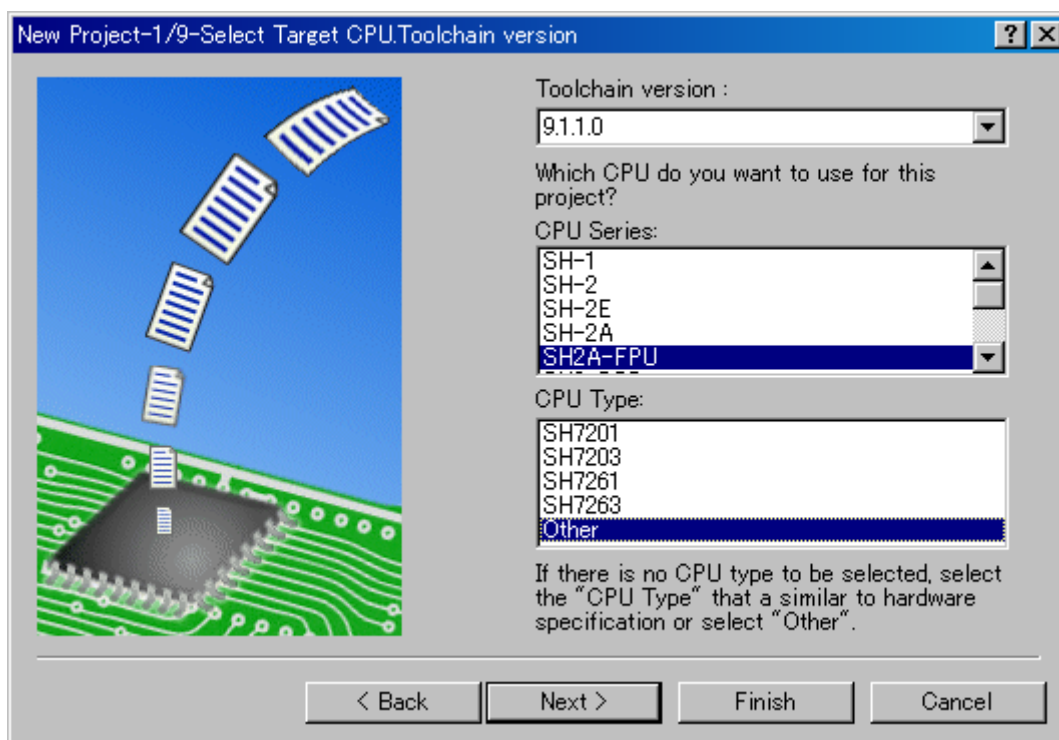

Figure 5.1.3 New Project-1/9 Dialog Box

- (8) Specify the global options from [New Project--2/9] dialog box.

FPU: Single
Round: Zero

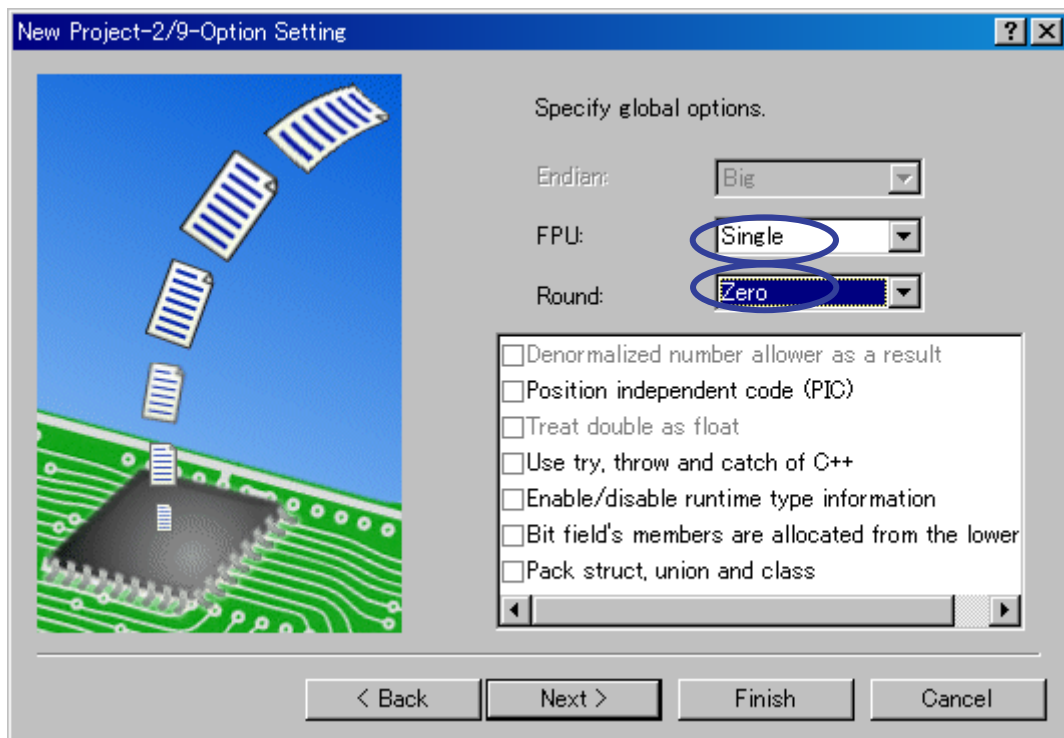

Figure 5.1.4 [New Project-2/9] Dialog Box

- (9) Fill out [New Project-3/9] to [New Project-4/9] dialog boxes. Select the check boxes as necessary. Leave default settings intact here and simply click "Next".

(10) In [New Project-5/9] dialog box, set up a stack as follows;

Stack Pointer Address: H'FFF88000

Stack Size: H'400

*Stack size can be changed according to need.

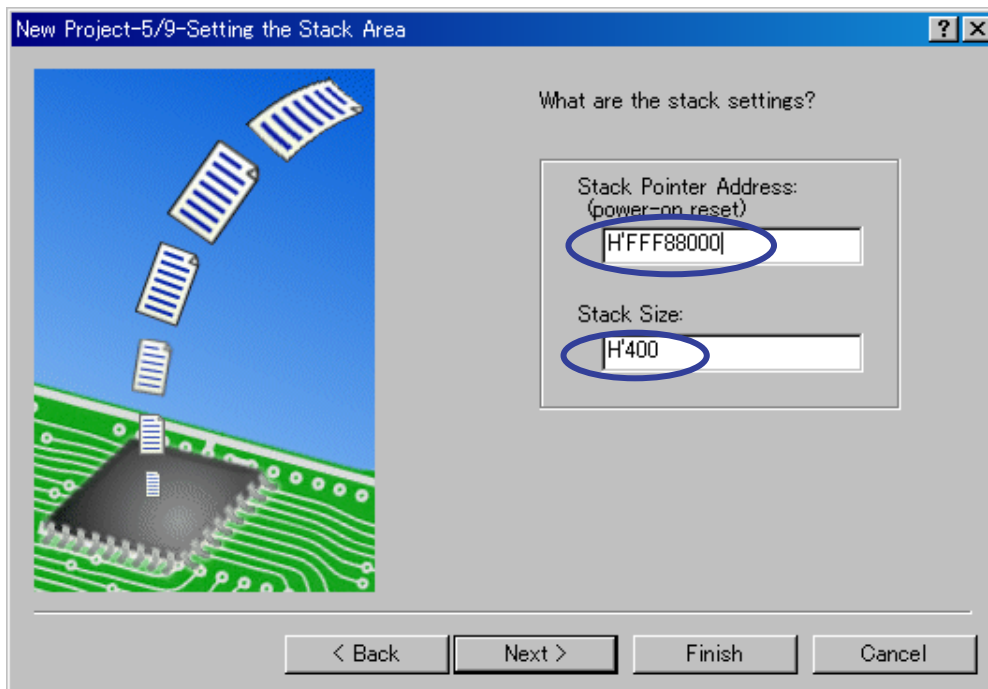

Figure 5.1.5 New Project-5/9 Dialog Box

(11) In [New Project-6/9] dialog box, set up a vector.

Here, leave default settings intact (with the Vector Definition Files check box selected) and simply click "Next".

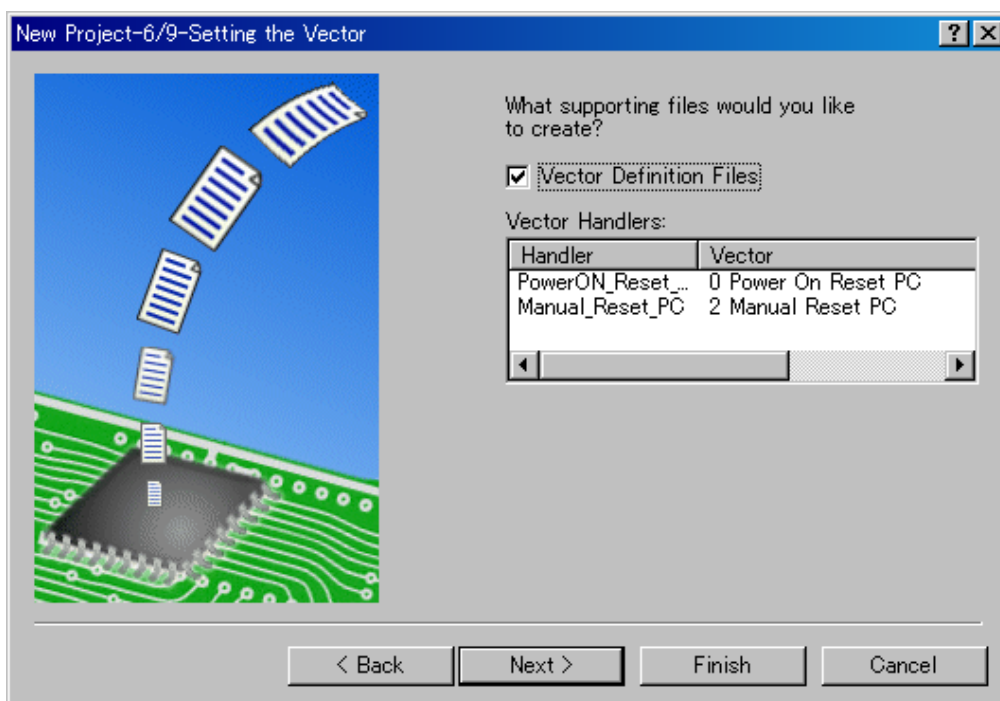

Figure 5.1.6 New Project-6/9 Dialog Box

(12) In [New Project-7/9] dialog box, set up the target as below. Firstly, select the Target type and then, select the Targets.

Target type: SH2A-FPU

Targets: SH2A-FPU E10A-USB SYSTEM(SH2A)

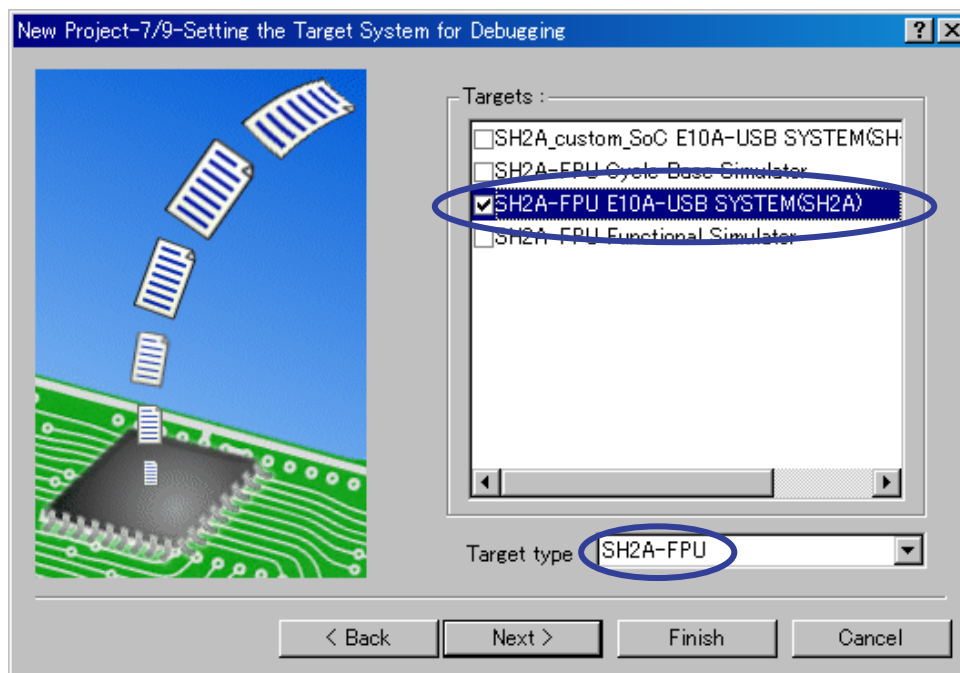

Figure 5.1.7 New Project-7/9 Dialog Box

(13) Verify [New Project-8/9] and [New Project-9/9] dialog boxes and click "Finish".

Quit the Project Generator following the instructions shown in the window.

The HEW will be activated, automatically generating standard source files for the SH-2A device group.

(14) After the HEW started up, connect the E10A-USB emulator.

The E10A-USB emulator can be connected simply by switching to the session file for the E10A-USB emulator.

Note: The dialog box which confirms the change of session is displayed. Click "YES".

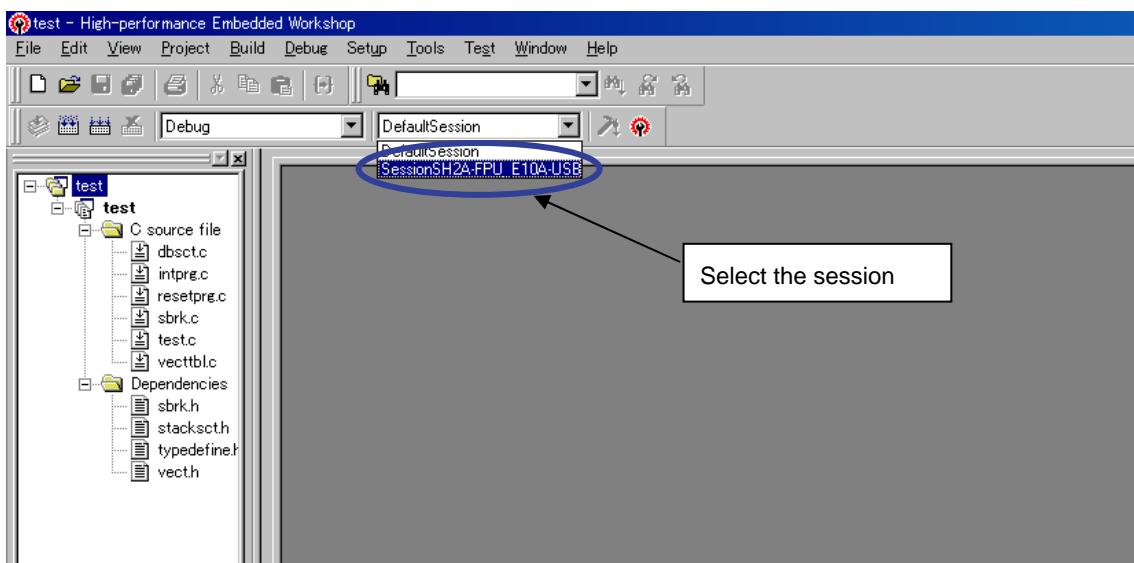

Figure 5.1.8 E10A-USB Emulator Connection Setup Screen

(15) [Select Emulator mode] dialog box shown below will be displayed.

For details on how to operate here, refer to paragraphs "4.1.2 SH7670 CPU board and E10A-USB Startup Procedure (HEW Startup)"

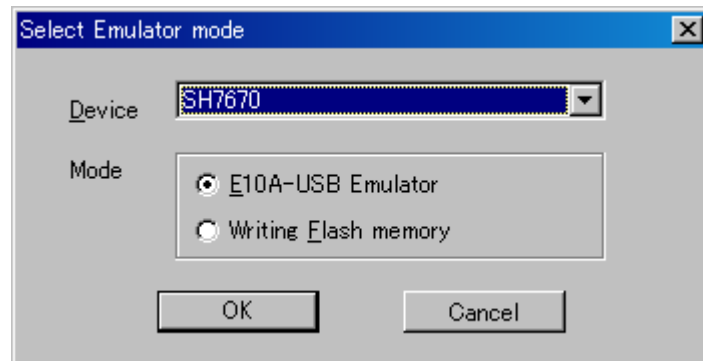

Figure 5.1.9 Select Emulator Mode Dialog Box

(16) Execute build processing.

Choose Build from the Build menu to execute build processing.

After the E10A-USB emulator has been connected, execute build processing once without modifying the standard source file. If a build error occurs here, the SuperH RISC engine C/C++ compiler may not have been installed normally.

5.2 Setting Up the Flash Memory Download

Next, the following shows how to set up the function for downloading load modules into the flash memory connected external to the SH7670 CPU board.

Here, we use the flash memory download program stored in

"C:\WorkSpace\Sample_software\sh7670_sample\fmtool_hs71.

For details about flash memory download settings, refer to the "SuperH Family E10A-USB Emulator User's Manual."

5.2.1 Setting Up the Flash Memory Download Function

Setting up the flash memory download function

From [Setup] menu → [Emulator] → [System...], select [Configuration] dialog box, and open [Loading flash memory] page.

For "File Name" here, specify the flash memory download program (fmtool_hs71.mot). The sample workspace is assumed to have the flash memory download program stored in the directory indicated below.

" C:\WorkSpace\Sample_software\sh7670_sample\fmtool_hs71"

Set up "Loading flash memory", "File name", "Bus width of flash memory" and "Entry point" as shown in Figure 5.2.1 and Table 5.2.1. Then click "OK"

Note: Loading Flash Memory is set to "Disable" in the default setting. Therefore, you need to [enable it whenever you connect the E10A-USB emulator](#).

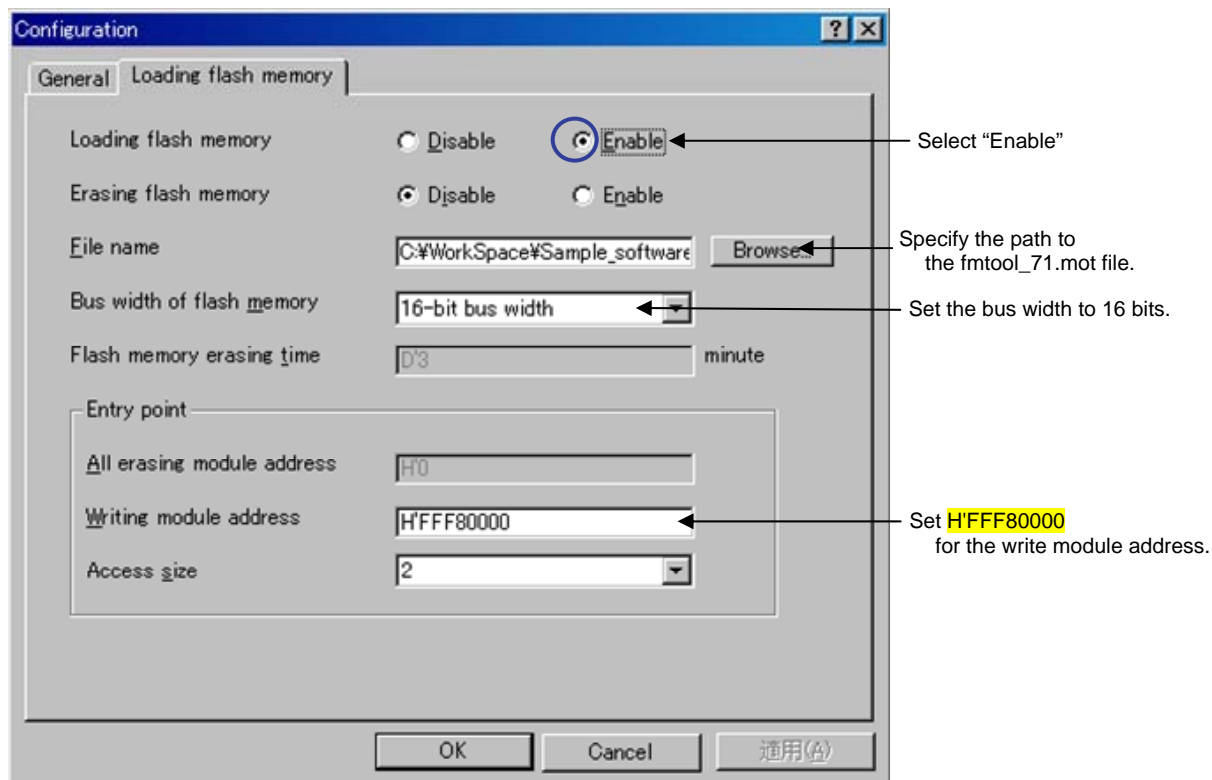

Figure 5.2.1 Configuration Dialog Box

Table 5.2.1 Loading flash memory Setting

Loading flash memory	Enable
Erasing flash memory	Disable
File name	C:\%Workspace%\Sample_software\sh7670_sample\fmtool_hs71\fmtool_hs71.mot
Bus width of flash memory	16-bit
Flash memory erasing time	-
All erasing module address	-
Writing module address	H'FFF80000
Access size	1 or 2

5.2.2 Specifying the Command Batch File Before Downloading

Next, you need to run the script file "fmtool_hs71.hdc" which has written the access timing and bus control signal settings in the flash memory of the SH7670 CPU board before you download the modules.

From the Debug menu, open the Debug Settings dialog box and select the Options tab. Set up the items on this tab as shown below.

- Command batch file load timing: Before download of modules
- Command line batch processing:

"%Workspace%\Sample_software\sh7670_sample\fmtool_hs71\fmtool_hs71.hdc "

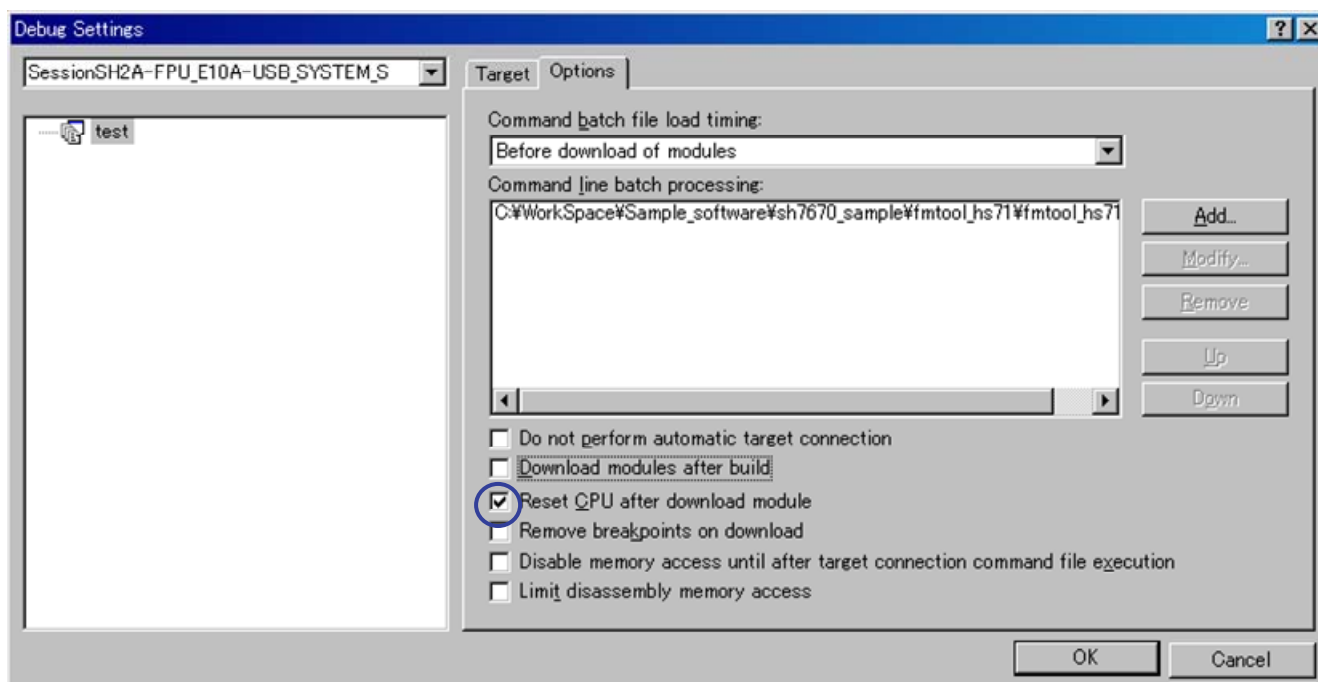

Figure 5.2.2 Debug Settings Dialog Box

Note: With default settings, "Download modules after build" is selected. So deselect this check box, and then select "Reset CPU after download module", as shown above.

5.2.3 Activating the Command Line Window

Choose Command Line from the View menu and open the Command Line window.

When downloading the load modules, activate the Command Line window to check whether the script file is running.

Note: Unless the script file is running, you cannot download the load modules into the flash memory. So be sure to check this.

5.3 Adding/Modifying Hardware Setup Files

For the software to be run on the SH7670 CPU board, the hardware dependent part of the SH7670 CPU board must be set up.

Here, the hardware dependent part of the SH7670 CPU board is added or modified for the standard source files that were automatically generated when you created a new project. The procedure for adding/modifying hardware setup files is described below.

The setting of the hardware dependent part indicates the settings of external memory (flash memory, SDRAM) access timing, the operating clock and the cache memory.

5.3.1 Copying Hardware Setup Files

Copy "HardwareSetup" directory from the CD-ROM into the directory for the new project workspace "C:\WorkSpace\test" that you created previously.

The explanation given below assumes that the hardware setup files are stored in "C:\WorkSpace\test\HardwareSetup" directory.

5.3.2 Removing the Standard Source Files

- (1) Select [Project → Remove Files...].

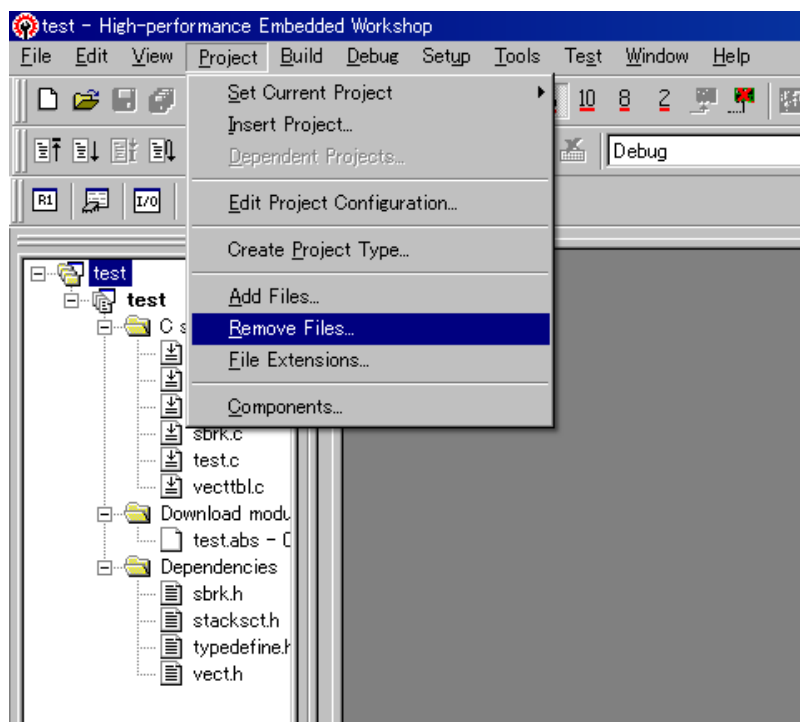

Figure 5.3.1 Setting Up to Removing Files (1)

- (2) From [Remove Project Files] dialog box, select the file of "dbsct.c", "intrpg.c", "resetprg.c", "sbrk.c", and "vecttbl.c". Then, click "Remove".

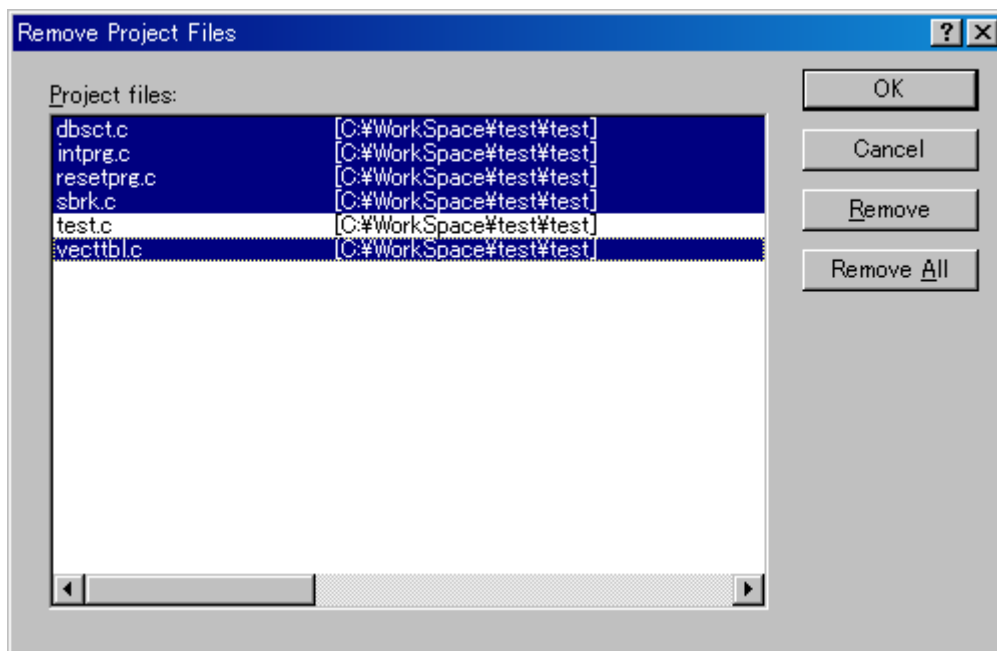

Figure 5.3.2 Setting Up to Removing Files (2)

5.3.3 Adding Hardware Setup Files

- (1) Select [Project → Add Files...].

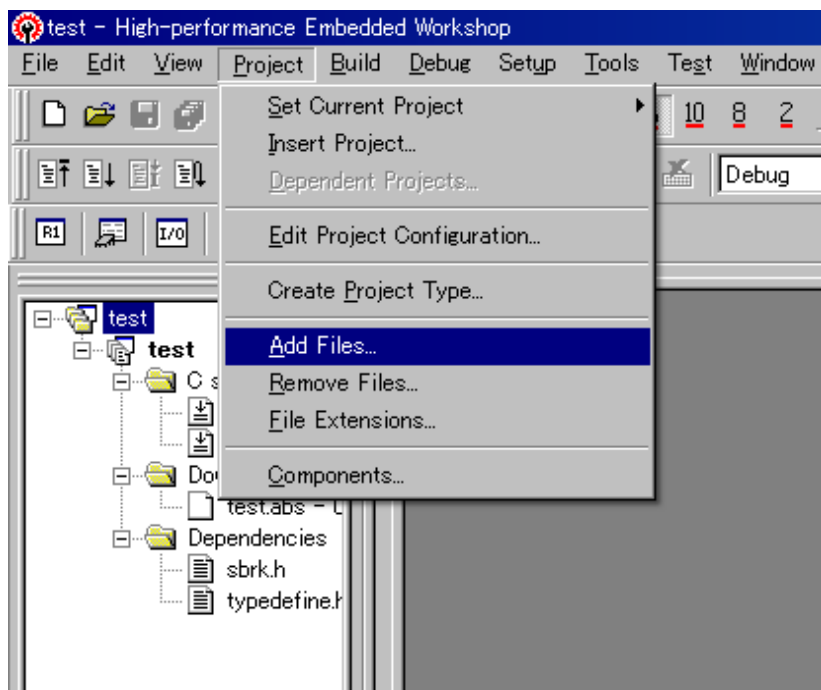

Figure 5.3.3 Setting Up to Add Files (1)

- (2) From the "C:\WorkSpace\test\HardwareSetup" directory to which you copied hardware setup files, add the files listed below.

Files to add : "bsc_cs0.c", "bscdram.c", "cache.c", "cpg.c", "dbstc.c", "hwsetup.c", "intprg.c", "lowsr.c", "resetprg.c", "sbrk.c", "siochar.c", "siorw.c", "vecttbl.c"
(Select the Relative Path check box)

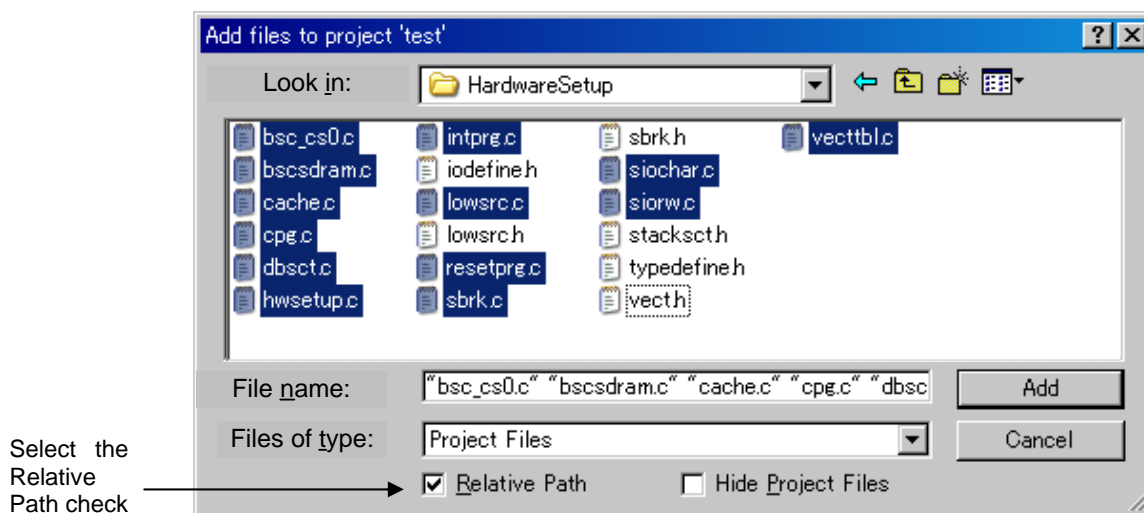

Figure 5.3.4 Setting Up to Add Files (2)

- (3) Check to see that the files have been added as shown below.

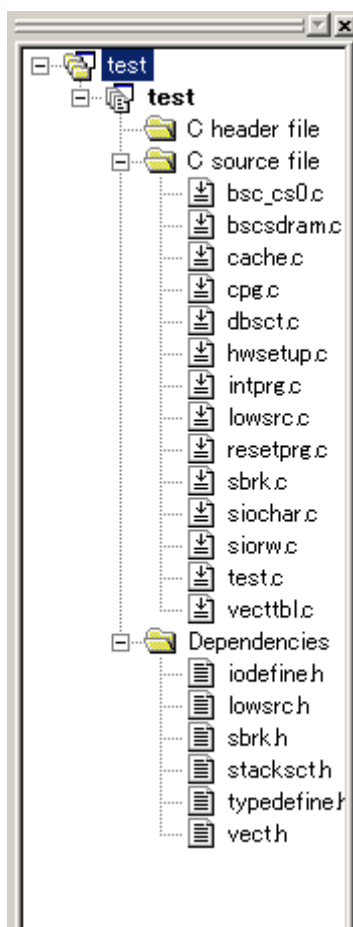

Figure 5.3.5 Setting Up to Add Files (3)

5.3.4 Setting Compiler Options

From the Build menu, open [SuperH RISC engine Standard Toolchain] dialog box and open [C/C++] tab. On this tab, set “Category”, “Show entries for” and “Options C/C++” as necessary.

For details on how to set “Option C/C++”, refer to the manuals for SuperH RISC engine C/C++ compiler, assembler and optimization linkage editor.

In the installation described here, because the include files for the hardware dependent part of the SH7670 CPU board are stored in a separate directory other than the default project directory, you need to set an additional relative path to the include file directory.

- Default project directory: "C: ¥WorkSpace¥test¥test"
- Directory in which the include files are stored: "C: ¥WorkSpace¥test¥HardwareSetup"

The following shows how to set a relative path to the include file directory.

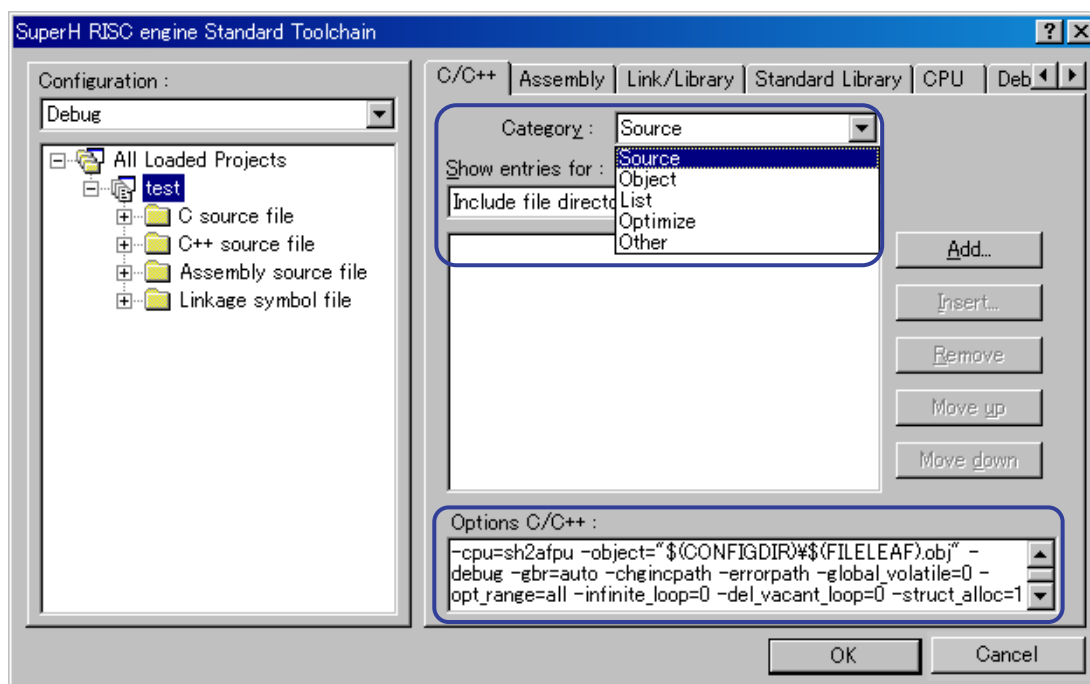

Figure 5.3.6 Compiler Option Setup Window

(1) Open “C/C++” tab of [SuperH RISC engine Standard Toolchain] dialog box, set up the following, and click the “Add...”.

- Category: Source
- Show entries for: Include file directory

(2) Open [Add include file directory] dialog box, make selections as shown below, and press “OK”.

- Relative to: Select “Workspace directory” from the dropdown list.
- Sub-directory: Enter “HardwareSetup” in the text box.

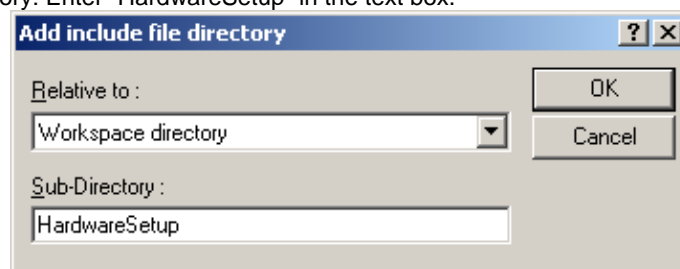

Figure 5.3.7 Add Include File Directory Dialog Box

5.3.5 Setting Linker Options

Open the Build menu, open the dialog box [SuperH RISC engine Standard Toolchain], and select “Link/Library” tab. Set “Category”, “Show entries for”, and “Option Link/Library” appropriately as necessary.

For details on how to set optimization linker options, refer to the user’s manuals for SuperH RISC engine C/C++ compiler, assembler and optimization linkage editor.

Here, the following describes how to change section settings.

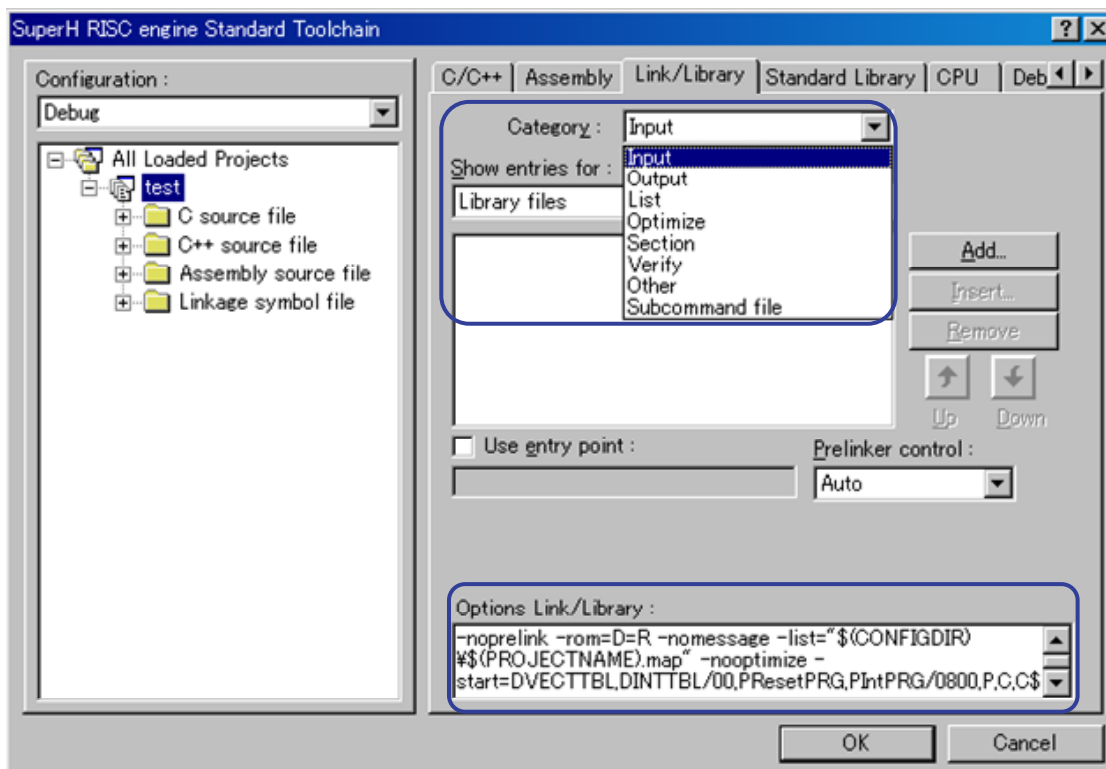

Figure 5.3.8 Linker Option Setup Window

(a) Section setting example for the case that a cache memory setup function is used

To use the `io_init_cache` function (that sets cache memory), the section for it must be located in the non-cacheable area of CS0. The following shows how to set up the section to the non-cacheable area of CS0.

For the details about cache memory, refer to the chapters of cache and BSC in SH7670 group hardware manual.

- (1) From the Build menu, open [SuperH RISC engine Standard Toolchain] dialog box and then the Link/Library tab. On this tab, select the following and then click "Edit".
 - Category: Section
 - Show entries for: Section

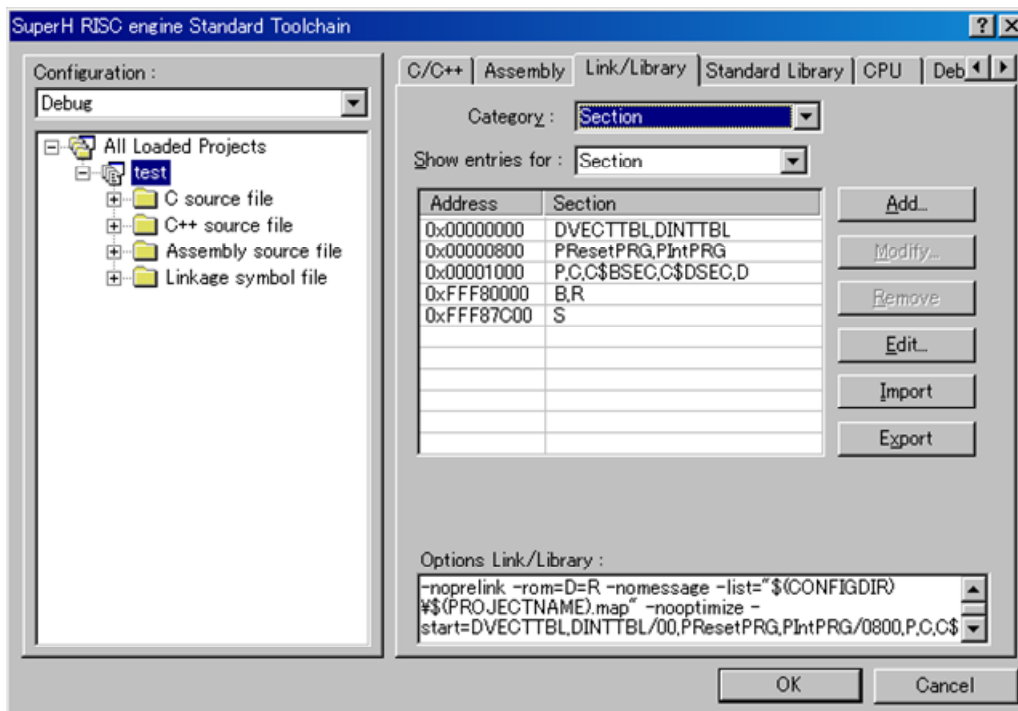

Figure 5.3.9 Section Settings (1)

- (2) [Section] dialog box shown below will be displayed. In this dialog box, click "Add".

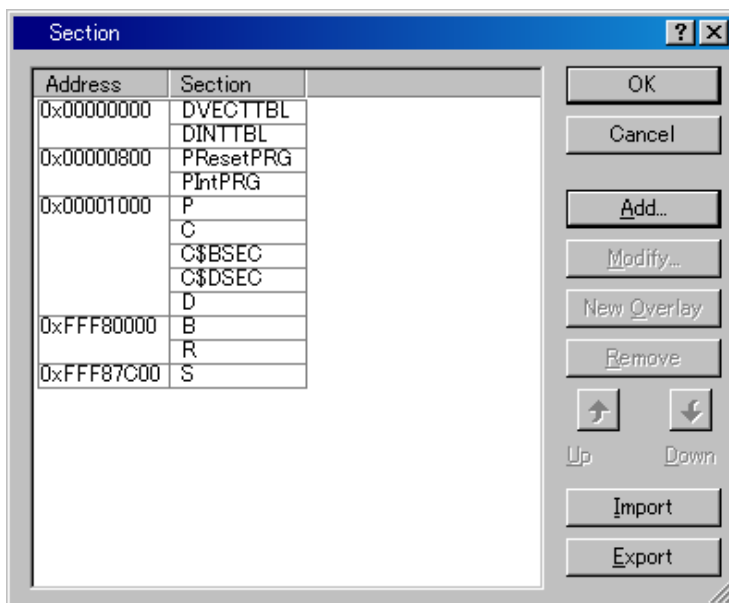

Figure 5.3.10 Section Settings(2)

- (3) [Section address] dialog box shown below will be displayed. In this dialog box, enter "0x207FF000" for the Address as shown in Figure 5.3.11, and press "OK".

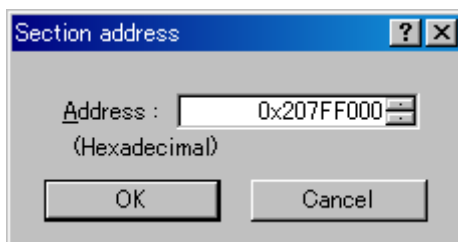

Figure 5.3.11 Section Settings (3)

- (4) The section address will be added and it returns to [Section] dialog box. Choose a blank section as shown in Figure 5.3.12, and click "Add".

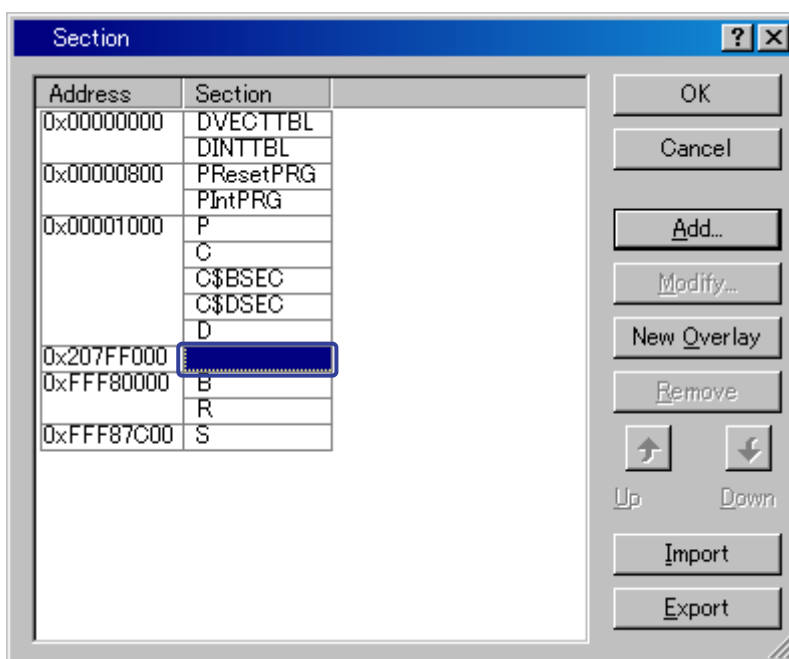

Figure 5.3.12 Section Settings (4)

(5) [Add section] dialog box shown below will be displayed. Enter "PCACHE" for "Section name" as shown in Figure 5.3.13, and press "OK".

The "CACHE" section is defined in the "cache.c" source file. The first character "P" indicates a P section.

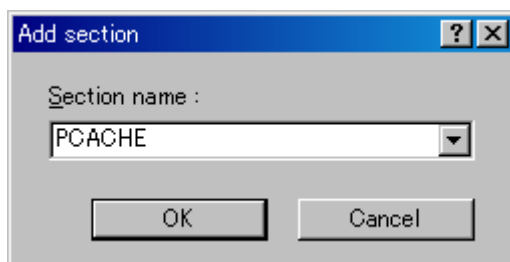

Figure 5.3.13 Section Settings (5)

(6) The section name will be added, and it returns to [Section] dialog box. Confirm if the section has been set as shown in Figure 5.3.14, and press "OK".

It returns to the SuperH RISC engine Standard Toolchain dialog box, so press "OK" to finish your settings

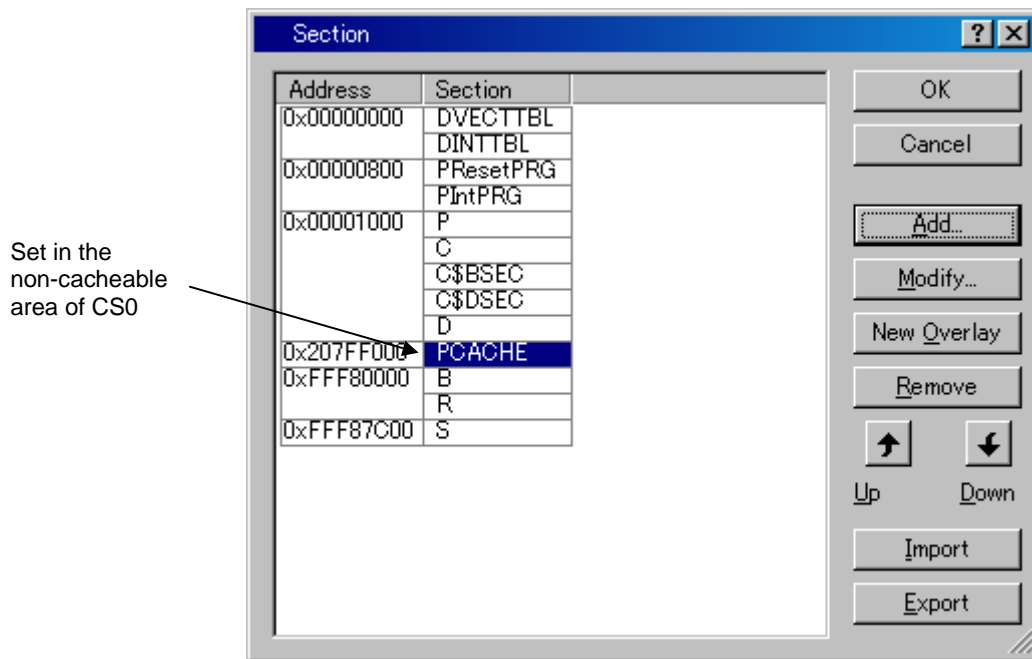

Figure 5.3.14 Section Settings (6)

(b) Section modifications example for the case that a B section is changed to the SDRAM area

The following shows the section modification example for changing the location of a B section to the SDRAM area.

For a detailed procedure for section setting, refer to paragraph (a) described previously.

- (1) In [Section] dialog box, select "B" section as shown in Figure 5.3.15, and click "Remove".

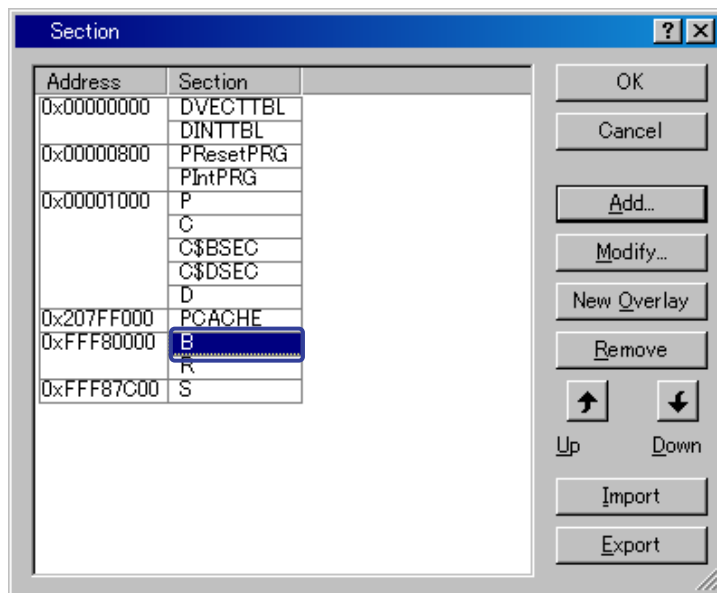

Figure 5.3.15 Section Change (1)

- (2) In [Section] dialog box, set the B section in the SDRAM area as shown in Figure 5.3.16.

Example: Adding a section to the SDRAM

- Address: 0x0C000000
- Section: B

Note: For details about the SDRAM area in the SH7670 CPU board, refer to Section 1.7, "SH7670 Memory Mapping," in the SH7670 CPU board User's Manual.

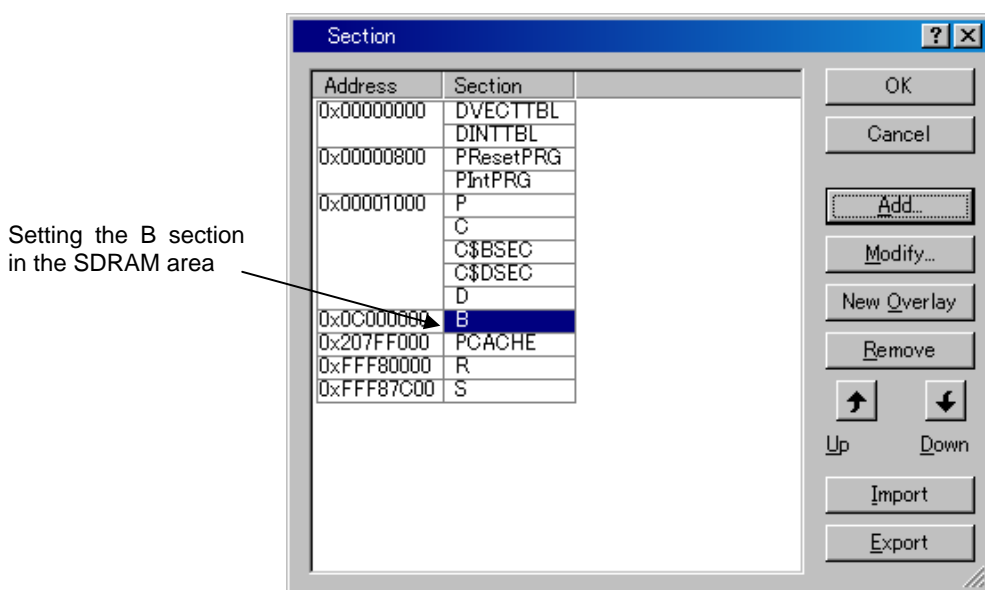

Figure 5.3.16 Section Change (2)

(c) Setting example for section in case for forwarding vector table section DINTTBL to on-chip RAM

Interrupt response speed can be sped up by forwarding vector table to on-chip RAM, and using register bank.

Forwarding vector table sets the vector table section on ROM as DINTTBL, and sets the section on RAM for the forwarding destination as RINTTBL with "dbsct.c" added by 5.3.3.

<Section definition for vector table>

- Section name of vector table (ROM section): DINTTBL
- Section name of forwarding destination (RAM section): RINTTBL

The following shows the section setting procedure to modify the DINTTBL section from ROM to on-chip RAM in the sample program.

(1) Set the RINTTBL section to on-chip RAM area in [Section] dialog box as shown in Figure 5.3.17.

<Example for adding section to on-chip RAM area>

"Address": 0xFFFF80000

"Section": RINTTBL

Note: When the address above is set, the vector base register of CPU should be set. In the sample software, the vector base register should be set inside the reset exception handling in the resetprg.c file.

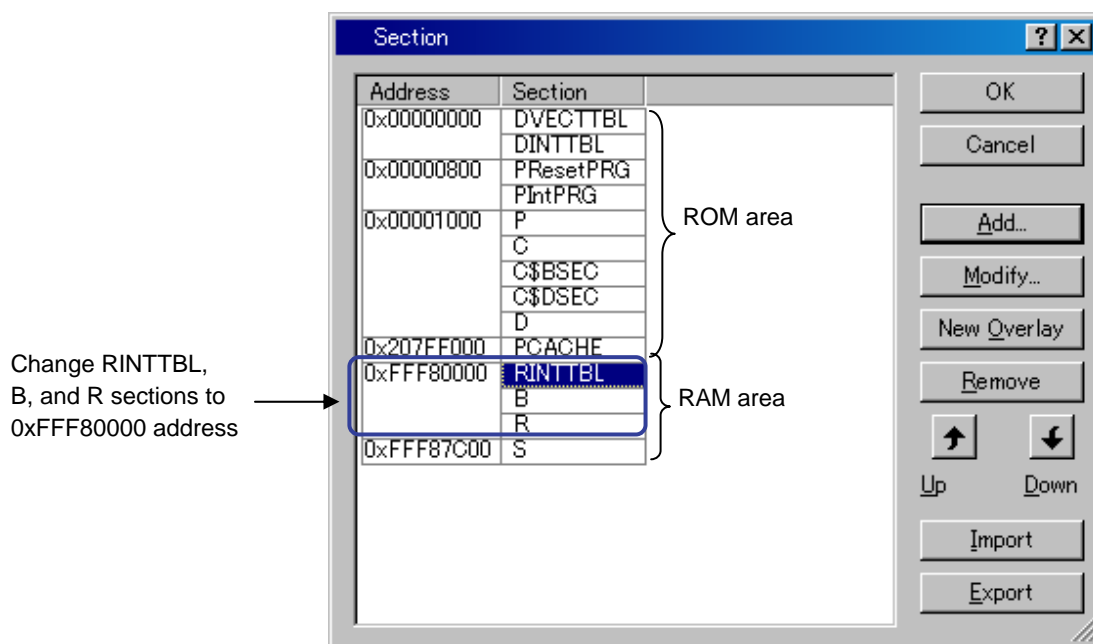

Figure 5.3.17 Section Change (1)

(2) Open [Link/Library] tab and select the below, and click "Add".

- Category : Output
- Show entries for : ROM to RAM mapped sections

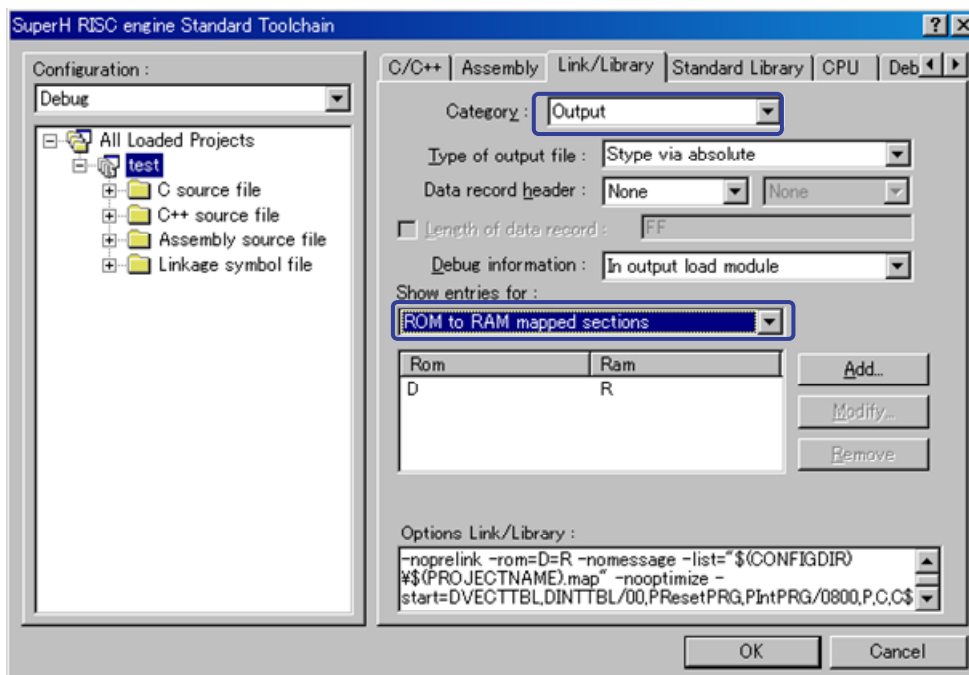

Figure 5.3.18 Section Change (2)

Note: In the sample software, the section initialization table should be set inside the reset exception handling in the dbst.c file.

(3) Select the items as below on [Add Rom to Ram] dialog box, and click "OK".

It returns to [SuperH RISC engine Standard Toolchain] dialog box, and click "OK" to finish your setting.

- ROM section : DINTTBL
- RAM section : RINTTBL

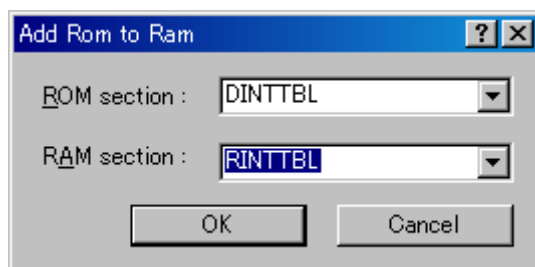

Figure 5.3.19 Section Change (3)

5.3.6 Writing the Main Function (Operation Confirmation)

In the main function (test.c source file), write a program to turn on the LED (LED7 on the SH7670 CPU board lights up).

- Open the source file C:¥Workspace¥test¥test¥test.c with an editor, etc.
- Write the program that is shown below to turn on the LED.

```
Omitted
11: #include "iodefine.h"
12:
13: void main(void)
14: {
15:     /* ==== Port setting ==== */
16:     PORT.PCCR1.BIT.PC20MD = 0;
17:     PORT.PCDRH.BIT.PC20DR = 0;
18:
19:     /* ====Port output (LED lights up) ==== */
20:     PORT.PCIORH.BIT.PC20IOR = 1;
21: }
22:
```

Note: In this example, the value is set to the port C data register H (PCDRH) by the bit operation instruction. Since the bit operation instruction performs the read modify write access, the port input level read for the unspecified bit is written in the port data register. As a result, please note that the unintended value might be set. In the other ports

(1) Creating a new load module

Choose Build from the Build menu to execute build processing.

Note: Because the C section is not used, the following warning message will be displayed. It does not present any problem.

```
<Warning message>
L1100(W)Cannot find "C" specified in option "start"
Phase OptLinker finished

Build Finished
0 Errors,1 Warning
```

(2) Creation of new test.abs

If a new load module (test.abs) has been created, it means that you've finished adding/modifying hardware setup files successfully.

(3) Running the program

Try running the program after downloading the load module. (LED7 on the SH7670 CPU board lights up)

This page is blank

Rev.	Date of Issue	Content of Revision	
		Page	Points
1.00	Jan 9.08	-	First edition issued.
1.01	May 7.08	-	Revision history page location was changed. Colophon was changed from ©2007 to ©2008.

SH7670 CPU Board
M3A-HS71
Installation Manual

Publication Date May 7, 2008 Rev. 1.01

Published by Renesas Technology Corp.
Renesas Solutions Corp.

**SH7670 CPU Board
M3A-HS71
Installation Manual**



Renesas Electronics Corporation

1753, Shimonumabe, Nakahara-ku, Kawasaki-shi, Kanagawa 211-8668 Japan

REJ11J0015-0101