

RH850 Evaluation Platform

RH850/F1x 64pin  
RH850/F1Kx 64pin

PiggyBack board V1

Y-RH850-F1X-064PIN-PB-T1-V1

All information contained in these materials, including products and product specifications, represents information on the product at the time of publication and is subject to change by Renesas Electronics Corp. without notice. Please review the latest information published by Renesas Electronics Corp. through various means, including the Renesas Technology Corp. website (<http://www.renesas.com>).

The newest version of this document can be obtained from the following web location  
<http://www.renesas.eu/updates?oc=Y-RH850-F1X-064PIN-PB-T1-V1>

## Notice

1. Descriptions of circuits, software and other related information in this document are provided only to illustrate the operation of semiconductor products and application examples. You are fully responsible for the incorporation of these circuits, software, and information in the design of your equipment. Renesas Electronics assumes no responsibility for any losses incurred by you or third parties arising from the use of these circuits, software, or information.
2. Renesas Electronics has used reasonable care in preparing the information included in this document, but Renesas Electronics does not warrant that such information is error free. Renesas Electronics assumes no liability whatsoever for any damages incurred by you resulting from errors in or omissions from the information included herein.
3. Renesas Electronics does not assume any liability for infringement of patents, copyrights, or other intellectual property rights of third parties by or arising from the use of Renesas Electronics products or technical information described in this document. No license, express, implied or otherwise, is granted hereby under any patents, copyrights or other intellectual property rights of Renesas Electronics or others.
4. You should not alter, modify, copy, or otherwise misappropriate any Renesas Electronics product, whether in whole or in part. Renesas Electronics assumes no responsibility for any losses incurred by you or third parties arising from such alteration, modification, copy or otherwise misappropriation of Renesas Electronics product.
5. Renesas Electronics products are classified according to the following two quality grades: "Standard" and "High Quality". The recommended applications for each Renesas Electronics product depends on the product's quality grade, as indicated below.

"Standard": Computers; office equipment; communications equipment; test and measurement equipment; audio and visual equipment; home electronic appliances; machine tools; personal electronic equipment; and industrial robots etc.

"High Quality": Transportation equipment (automobiles, trains, ships, etc.); traffic control systems; anti-disaster systems; anti-crime systems; and safety equipment;

Renesas Electronics products are neither intended nor authorized for use in products or systems that may pose a direct threat to human life or bodily injury (artificial life support devices or systems, surgical implantations etc.), or may cause serious property damages (nuclear reactor control systems, military equipment etc.). You must check the quality grade of each Renesas Electronics product before using it in a particular application. You may not use any Renesas Electronics product for any application for which it is not intended. Renesas Electronics shall not be in any way liable for any damages or losses incurred by you or third parties arising from the use of any Renesas Electronics product for which the product is not intended by Renesas Electronics.

6. You should use the Renesas Electronics products described in this document within the range specified by Renesas Electronics, especially with respect to the maximum rating, operating supply voltage range, movement power voltage range, heat radiation characteristics, installation and other product characteristics. Renesas Electronics shall have no liability for malfunctions or damages arising out of the use of Renesas Electronics products beyond such specified ranges.
7. Although Renesas Electronics endeavors to improve the quality and reliability of its products, semiconductor products have specific characteristics such as the occurrence of failure at a certain rate and malfunctions under certain use conditions. Further, Renesas Electronics products are not subject to radiation resistance design. Please be sure to implement safety measures to guard them against the possibility of physical injury, and injury or damage caused by fire in the event of the failure of a Renesas Electronics product, such as safety design for hardware and software including but not limited to redundancy, fire control and malfunction prevention, appropriate treatment for aging degradation or any other appropriate measures. Because the evaluation of microcomputer software alone is very difficult, please evaluate the safety of the final products or systems manufactured by you.
8. Please contact a Renesas Electronics sales office for details as to environmental matters such as the environmental compatibility of each Renesas Electronics product. Please use Renesas Electronics products in compliance with all applicable laws and regulations that regulate the inclusion or use of controlled substances, including without limitation, the EU RoHS Directive. Renesas Electronics assumes no liability for damages or losses occurring as a result of your noncompliance with applicable laws and regulations.
9. Renesas Electronics products and technology may not be used for or incorporated into any products or systems whose manufacture, use, or sale is prohibited under any applicable domestic or foreign laws or regulations. You should not use Renesas Electronics products or technology described in this document for any purpose relating to military applications or use by the military, including but not limited to the development of weapons of mass destruction. When exporting the Renesas Electronics products or technology described in this document, you should comply with the applicable export control laws and regulations and follow the procedures required by such laws and regulations.
10. It is the responsibility of the buyer or distributor of Renesas Electronics products, who distributes, disposes of, or otherwise places the product with a third party, to notify such third party in advance of the contents and conditions set forth in this document, Renesas Electronics assumes no responsibility for any losses incurred by you or third parties as a result of unauthorized use of Renesas Electronics products.
11. This document may not be reproduced or duplicated in any form, in whole or in part, without prior written consent of Renesas Electronics.

Please contact a Renesas Electronics sales office if you have any questions regarding the information contained in this document or Renesas Electronics products, or if you have any other inquiries.

(Note 1) "Renesas Electronics" as used in this document means Renesas Electronics Corporation and also includes its majority-owned subsidiaries.

(Note 2) "Renesas Electronics product(s)" means any product developed or manufactured by or for Renesas Electronics.

---

## General Precautions in the Handling of Microprocessing Unit and Microcontroller Unit Products

The following usage notes are applicable to all Microprocessing unit and Microcontroller unit products from Renesas. For detailed usage notes on the products covered by this document, refer to the relevant sections of the document as well as any technical updates that have been issued for the products.

1. Handling of Unused Pins  
Handle unused pins in accordance with the directions given under Handling of Unused Pins in the manual.
  - The input pins of CMOS products are generally in the high-impedance state. In operation with an unused pin in the open-circuit state, extra electromagnetic noise is induced in the vicinity of LSI, an associated shoot-through current flows internally, and malfunctions occur due to the false recognition of the pin state as an input signal become possible. Unused pins should be handled as described under Handling of Unused Pins in the manual.
2. Processing at Power-on  
The state of the product is undefined at the moment when power is supplied.
  - The states of internal circuits in the LSI are indeterminate and the states of register settings and pins are undefined at the moment when power is supplied.  
In a finished product where the reset signal is applied to the external reset pin, the states of pins are not guaranteed from the moment when power is supplied until the reset process is completed. In a similar way, the states of pins in a product that is reset by an on-chip power-on reset function are not guaranteed from the moment when power is supplied until the power reaches the level at which resetting has been specified.
3. Prohibition of Access to Reserved Addresses  
Access to reserved addresses is prohibited.
  - The reserved addresses are provided for the possible future expansion of functions. Do not access these addresses; the correct operation of LSI is not guaranteed if they are accessed.
4. Clock Signals  
After applying a reset, only release the reset line after the operating clock signal has become stable. When switching the clock signal during program execution, wait until the target clock signal has stabilized.
  - When the clock signal is generated with an external resonator (or from an external oscillator) during a reset, ensure that the reset line is only released after full stabilization of the clock signal. Moreover, when switching to a clock signal produced with an external resonator (or by an external oscillator) while program execution is in progress, wait until the target clock signal is stable.
5. Differences between Products  
Before changing from one product to another, i.e. to a product with a different part number, confirm that the change will not lead to problems.
  - The characteristics of Microprocessing unit or Microcontroller unit products in the same group but having a different part number may differ in terms of the internal memory capacity, layout pattern, and other factors, which can affect the ranges of electrical characteristics, such as characteristic values, operating margins, immunity to noise, and amount of radiated noise. When changing to a product with a different part number, implement a system-evaluation test for the given product.

---

## Table of Contents

<b>Chapter 1</b>	<b>Introduction .....</b>	<b>5</b>
<b>Chapter 2</b>	<b>Overview .....</b>	<b>6</b>
2.1	Overview .....	6
2.2	Mounting of the device .....	7
<b>Chapter 3</b>	<b>Power supply .....</b>	<b>8</b>
3.1	Board power connections .....	8
3.2	Voltage distribution .....	9
<b>Chapter 4</b>	<b>Clock sources .....</b>	<b>10</b>
4.1.1	MainOsc .....	10
<b>Chapter 5</b>	<b>Debug and Programming interface .....</b>	<b>11</b>
<b>Chapter 6</b>	<b>Connectors for ports of device .....</b>	<b>12</b>
6.1	Push button for RESET .....	12
6.2	Connectors to MainBoard .....	12
6.2.1	Connector CN1 .....	12
6.2.2	Connector CN2 .....	14
6.2.3	Connector CN3 .....	15
<b>Chapter 7</b>	<b>Mechanical dimensions .....</b>	<b>17</b>
<b>Chapter 8</b>	<b>Schematic .....</b>	<b>18</b>
<b>Chapter 9</b>	<b>Revision History .....</b>	<b>21</b>

---

## Chapter 1 Introduction

The RH850/F1x Application Board is part of the RH850 Evaluation Platform and serves as a simple and easy to use platform for evaluating the features and performance of Renesas Electronics 32-bit RH850/F1x microcontrollers. The piggyback board (Y-RH850-F1X-064PIN-PB-T1-V1) can be used as a standalone board, or can be mated with a mainboard (e.g. Y-RH850-X1X-MB-Tx-Vx) for extended functionality.

Main features:

- Socket for mounting of device
- Standalone operation of the board
- Direct supply of device voltage (typ. 3.3V-5.0V)
- Device programming capability
- Device debugging capability
- Pin headers for direct access to each device pin
- Reset switch
- MainOSC circuitry
- Connectors to MainBoard

This document describes the functionality provided by the piggyback board and guides the user through its operation.

# Chapter 2 Overview

## 2.1 Overview

Figures 1 and 2 provide the views of the Piggyback Board.

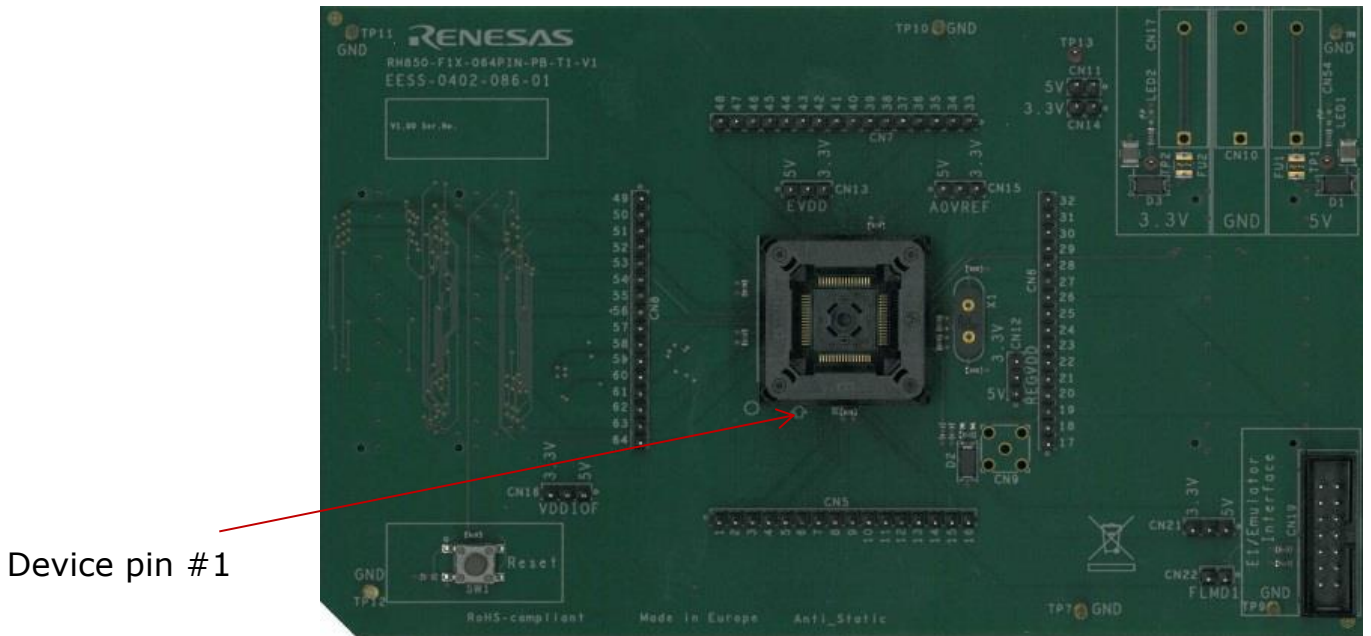

Figure 1 – PiggyBoard top view

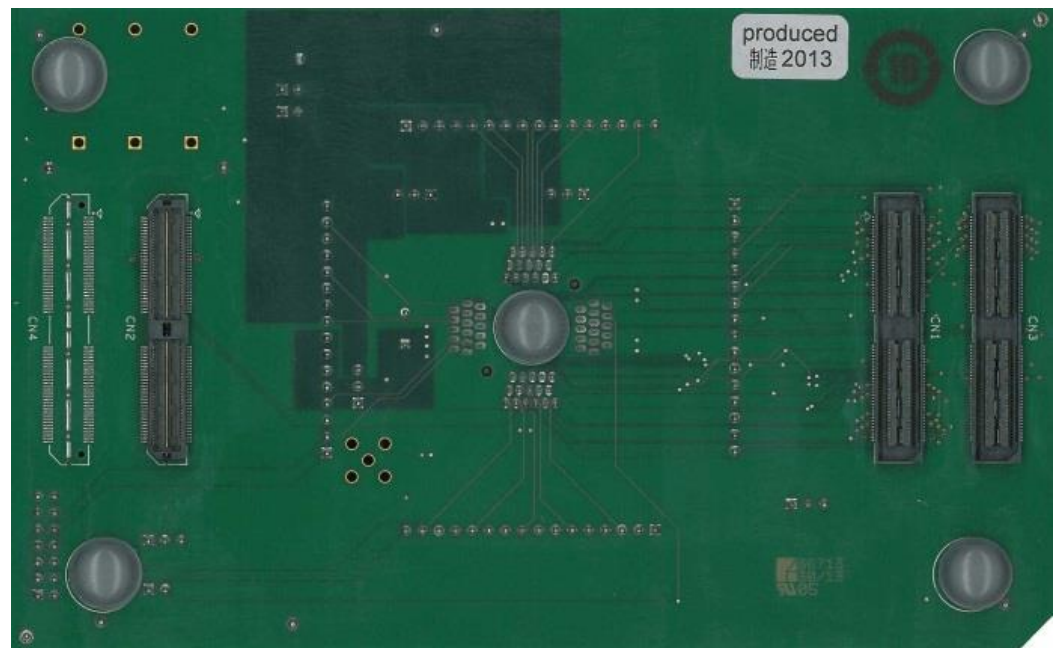

Figure 2 – PiggyBoard bottom view

---

## 2.2

### Mounting of the device

The board is designed for use with the following device:

- RH850/F1L 64pin
- RH850/F1KM-S1 64pin

The device must be placed inside the socket IC1. To insert the device, press down the lid, align the #1 pin of the device to the #1 pin of the socket, insert the device inside the socket and release the lid.

For details regarding the operation of the microcontrollers, refer to the RH850/F1L or RH850/F1KM User's Manual.

---

## Chapter 3 Power supply

### 3.1 Board power connections

For operation of the device, a supply voltage must be connected to the board. Though a single supply voltage is sufficient for the operation of the device, two (different) voltages can be supplied to the board.

Within this document the following voltages are considered as 'typical' connections:

*Voltage1* = 5.0V

*Voltage2* = 3.3V

The following connectors are available to supply those voltages:

- Three 4mm 'banana-type' connectors:
  - Two red connectors for voltages *Voltage1* (CN54) and *Voltage2* (CN17).
  - A black connector for VSS connection (CN10).

**Note:** The three connectors are supplied with the board but not assembled.
- The E1 emulator that is used for debug purposes and flash programming can also supply a single operating voltage ('Dbg\_Voltage').  
The voltage is programmable via the E1 GUI as 3.3 or 5.0V (typ).  
See the documentation of the E1 and chapter 5 'Debug and Programming interface' for details.
- In case the PiggyBoard is mounted on a MainBoard, the voltages *Voltage1* and *Voltage2* are supplied by the on-board regulators of the MainBoard.

**NOTE:** Do not supply any voltage directly to the PiggyBoard in case it is mounted on the MainBoard.

For each of the two voltages, 'Voltage 1' and 'Voltage 2', a green LED (LED1 and LED2) is available to signal that the related voltage is available on the PiggyBoard.



## 3.2

### Voltage distribution

The table shows the required device power supply pins and their function:

Device supply pin	Function
REGVDD	Supply for the device <u>internal regulators</u> for the digital logic.
EVDD	Supply for <u>ports</u> of AWO and ISO area.
A0VREF	Supply for <u>ports</u> and <u>analog functions</u> of ADC0.

Additionally one power supply for MainBoard can be selected:

Supply voltage	Function
VDDIOF	IO supply voltage for components located on a connected mainboard.

- For each of the above voltages, the voltage source can be selected from *Voltage1* (typ. 5.0V) or *Voltage2* (typ. 3.3V) by the jumpers CN12, CN13, CN15, CN16, respectively by the jumpers CN11 and CN14.

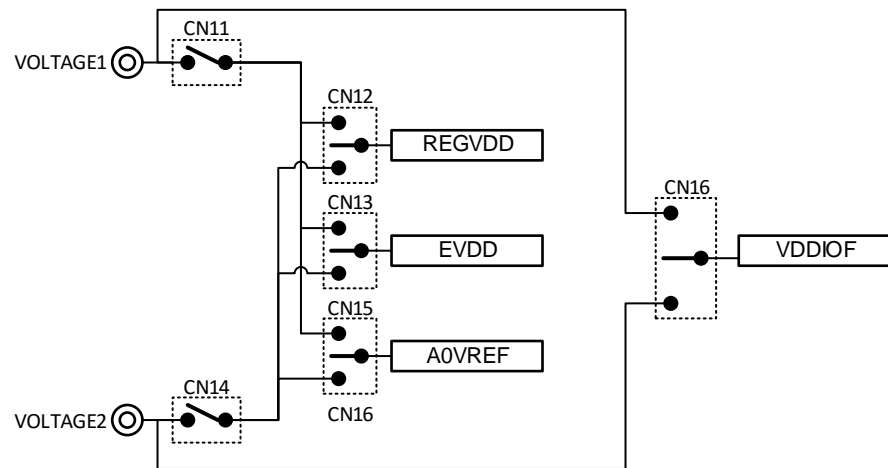

---

## Chapter 4 Clock sources

### 4.1.1 MainOsc

A crystal or ceramic resonator in the range of 8MHz to 24MHz can be mounted on socket X1.

A 8MHz and 16Mhz oscillator is supplied with the board.

---

## Chapter 5 Debug and Programming interface

For connection of the microcontroller debug and flash programming tools, the connector CN19 is provided.

The signal connection of the connector CN19 is shown in the picture below:

CN19 pin	Device Port	Device signal
1	JP0_2	DCUTCK / LPDCLK
2	GND	GND
3	JP0_4	DCUTRST
4	FLMD0	FLMD0
5	JP0_1	DCUTDO / LPDO
6	P10_8*	FLMD1
7	JP0_0	DCUTDI / LPDI
8	'Dbg_Voltage'	-
9	JP0_3	DCUTMS
10	-	-
11	JP0_5	DCURDY / LPDCLKOUT
12	GND	-
13	RESET	-
14	GND	-

\* In case the FLMD1 signal must be controlled by the debug/programming tool, the pin header CN22 must be closed.

The 'Dbg\_Voltage' (on CN19 pin 8) is monitored or supplied by the debug and flash programming tools. Therefore, it is necessary to select either Voltage1 (5V) or the Voltage2 (3.3V) by pin header CN21:

CN21 pin	Selection for Dbg_Voltage
1-2	5V is selected
2-3	3.3V is selected

## Chapter 6 Connectors for ports of device

Connection to each pin of the device is possible via the connectors CN5 to CN8.

*Note :The pin headers are directly connected to the pins, therefore special care must be taken to avoid any electrostatic or other damage to the device.*

### 6.1 Push button for RESET

In order to issue a RESET to the device, the push-button SW1 is available.

### 6.2 Connectors to MainBoard

Three connectors (CN1 to CN3) are available to connect the PiggyBoard to a MainBoard.

The signal connection of each connector is described in the following tables:

#### 6.2.1 Connector CN1

Pin	Function	Device Port	Pin	Function	Device Port
1	VDDA	-	2	VDDA	-
3	VDDA	-	4	VDDA	-
5	RESET	_RESET	6	NMI	P9_0
7	WAKE	-	8	-	-
9	INT0	P9_1	10	INT1	P0_6
11	INT2	P9_2	12	INT3	P9_3
13	-	-	14	-	-
15	UART0TX	P10_10	16	UART1TX	P0_5
17	UART0RX	P10_9	18	UART1RX	P0_4
19	LIN0TX	P10_10	20	LIN1TX	P10_5
21	LIN0RX	P10_9	22	LIN1RX	P10_4
23	IIC0SDL	P10_3	24	IIC1SDL	-
25	IIC0SDA	P10_2	26	IIC1SDA	-
27	CAN0TX	P10_1	28	CAN1TX	P0_3
29	CAN0RX	P10_0	30	CAN1RX	P0_2
31	SENTIN0	-	32	SENTIN1	-
33	SENTOUT0	-	34	SENTOUT1	-
35	PSI50Rx	-	36	PSI51Rx	-
37	PSI50Tx	-	38	PSI51Tx	-
39	PSI50Ssync	-	40	PSI51Sync	-
41	FLX0TX	-	42	FLX0EN	P10_11
43	FLX0RX	P10_14	44	-	-

45	FLX1TX	-
47	FLX1RX	-
49	-	-
51	ETH0MDIO	-
53	ETH0RXD0	-
55	ETH0RXD1	-
57	ETH0RXD2	-
59	ETH0RXD3	-
61	ETH0RXDCLK	-
63	ETH0RXER	-
65	ETH0CRSDV	-
67	ETH0RXDV	-
69	ETH0RESET	-
71	-	-
73	USB0UDMF	-
75	USB0UDPF	-
77	-	-
79	-	-
81	-	-
83	-	-
85	DIGIO_0	P8_0
87	DIGIO_2	P8_2
89	DIGIO_4	P8_4
91	DIGIO_6	P8_6
93	DIGIO_8	P10_0
95	DIGIO_10	P10_8
97	DIGIO_12	P0_9
99	DIGIO_14	P0_11
101	-	-
103	MUX0	P10_4
105	MUX2	P10_6
107	ADC0	AP0_0
109	ADC2	AP0_2
111	ADC4	AP0_4
113	ADC6	AP0_6
115	VDDIOF	-
117	VDDDB	-
119	VDDDB	-

46	FLX1EN	-
48	-	-
50	-	-
52	ETH0MDC	-
54	EH0TXD0	-
56	EH0TXD1	-
58	EH0TXD2	-
60	EH0TXD3	-
62	ETH0TXCLK	-
64	ETH0TXER	-
66	ETH0TXEN	-
68	ETH0COL	-
70	-	-
72	-	-
74	USB0UDMH	-
76	USB0UDPH	-
78	-	-
80	-	-
82	-	-
84	-	-
86	DIGIO_1	P8_1
88	DIGIO_3	P8_3
90	DIGIO_5	P8_5
92	DIGIO_7	P0_0
94	DIGIO_9	P10_7
96	DIGIO_11	P10_15
98	DIGIO_13	P0_10
100	DIGIO_15	P0_12
102	-	-
104	MUX1	P10_5
106	-	-
108	ADC1	AP0_1
110	ADC3	AP0_3
112	ADC5	AP0_5
114	ADC7	AP0_7
116	VDDIOF	-
118	VDDDB	-
120	VDDDB	-

## 6.2.2

## Connector CN2

Pin	Function	Device Port	Pin	Function	Device Port
1	CAN2Tx	-	2	CAN3Tx	-
3	CAN2Rx	-	4	CAN3Rx	-
5	CAN4Tx	-	6	CAN5Tx	-
7	CAN4Rx	-	8	CAN5Rx	-
9	LIN2Tx	-	10	LIN3Tx	-
11	LIN2Rx	-	12	LIN3Rx	-
13	LIN4Tx	-	14	LIN5Tx	-
15	LIN4Rx	-	16	LIN5Rx	-
17	LIN6Tx	-	18	LIN7Tx	-
Q	LIN6Rx	-	20	LIN7Rx	-
21	LIN8Tx	-	22	LIN9Tx	-
23	LIN8Rx	-	24	LIN9Rx	-
25	LIN10Tx	P10_10	26	LIN11Tx	P0_5
27	LIN10Rx	P10_9	28	LIN11Rx	P0_4
29	LIN12Tx	-	30	LIN13Tx	-
31	LIN12Rx	-	32	LIN13Rx	-
33	LIN14Tx	-	34	LIN15Tx	-
35	LIN14Rx	-	36	LIN15Rx	-
37	-	-	38	-	-
39	-	-	40	-	-
41	MLBCLK	-	42	MLBRESET	-
43	MLBSIG	-	44	MLBDAT	-
45	-	-	46	-	-
47	-	-	48	-	-
49	-	-	50	-	-
51	-	-	52	-	-
53	-	-	54	-	-
55	-	-	56	-	-
57	-	-	58	-	-
59	-	-	60	-	-
61	-	-	62	-	-
63	-	-	64	-	-
65	-	-	66	-	-
67	-	-	68	-	-
69	-	-	70	-	-
71	-	-	72	-	-
73	-	-	74	-	-
75	-	-	76	-	-
77	-	-	78	-	-
79	-	-	80	-	-

81	-	-
83	-	-
85	-	-
87	-	-
89	-	-
91	-	-
93	-	-
95	-	-
97	-	-
99	-	-
101	-	-
103	-	-
105	-	-
107	-	-
109	-	-
111	-	-
113	-	-
115	-	-
117	-	-
119	-	-

82	-	-
84	-	-
86	-	-
88	-	-
90	-	-
92	-	-
94	-	-
96	-	-
98	-	-
100	-	-
102	-	-
104	-	-
106	-	-
108	-	-
110	-	-
112	-	-
114	-	-
116	-	-
118	-	-
120	-	-

### 6.2.3 Connector CN3

Pin	Function	Device Port	Pin	Function	Device Port
1	PWM00	P10_0	2	PWM01	P10_1
3	PWM02	P10_2	4	PWM03	P10_3
5	PWM04	P10_7	6	PWM05	P10_8
7	PWM06	P10_9	8	PWM07	P10_10
9	PWM08	P9_0	10	PWM09	P9_1
11	PWM10	P0_4	12	PWM11	P0_1
13	PWM12	P0_2	14	PWM13	P0_3
15	PWM14	P8_0	16	PWM15	P8_1
17	PWM16	P10_11	18	PWM17	P10_12
Q	PWM18	P10_13	20	PWM19	P10_14
21	PWM20	P9_2	22	PWM21	P9_3
23	PWM22	P8_2	24	PWM23	P8_3
25	PWM24	-	26	PWM25	-
27	PWM26	-	28	PWM27	-
29	PWM28	-	30	PWM29	-
31	PWM30	-	32	PWM31	-
33	PWM32	-	34	PWM33	-
35	PWM34	-	36	PWM35	-

37	PWM36	-	38	PWM37	-
39	PWM38	-	40	PWM39	-
41	PWM40	-	42	PWM41	-
43	PWM42	-	44	PWM43	-
45	PWM44	-	46	PWM45	-
47	PWM46	-	48	PWM47	-
49	PWM48	-	50	PWM49	-
51	PWM50	-	52	PWM51	-
53	PWM52	-	54	PWM53	-
55	PWM54	-	56	PWM55	-
57	PWM56	-	58	PWM57	-
59	PWM58	-	60	PWM59	-
61	PWM60	-	62	PWM61	-
63	PWM62	-	64	PWM63	-
65	PWM64	-	66	PWM65	-
67	PWM66	-	68	PWM67	-
69	PWM68	-	70	PWM69	-
71	PWM70	-	72	PWM71	-
73	PWM72	-	74	PWM73	-
75	PWM74	-	76	PWM75	-
77	PWM76	-	78	PWM77	-
79	PWM78	-	80	PWM79	-
81	PWMADC00	AP0_8	82	PWMADC01	AP0_9
83	PWMADC02	-	84	PWMADC03	-
85	PWMADC04	-	86	PWMADC05	-
87	PWMADC06	-	88	PWMADC07	-
89	PWMADC08	-	90	PWMADC09	-
91	PWMADC10	-	92	PWMADC11	-
93	PWMADC12	-	94	PWMADC13	-
95	PWMADC14	-	96	PWMADC15	-
97	-	-	98	-	-
99	-	-	100	-	-
101	-	-	102	-	-
103	-	-	104	-	-
105	-	-	106	-	-
107	-	-	108	-	-
109	-	-	110	-	-
111	-	-	112	-	-
113	-	-	114	-	-
115	-	-	116	-	-
117	-	-	118	-	-
119	-	-	120	-	-



# Chapter 7 Mechanical dimensions

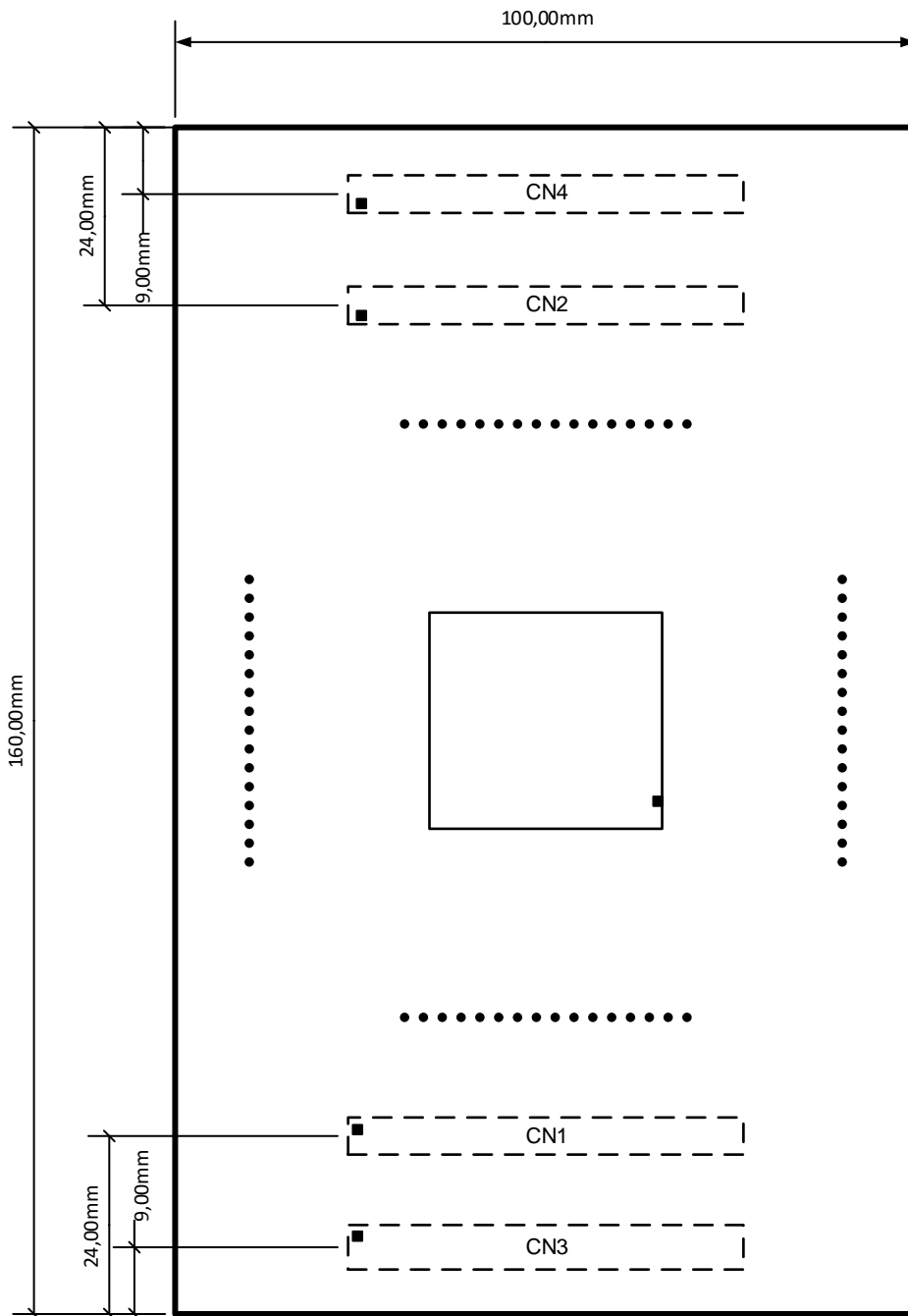

# Chapter 8 Schematic

## RH850\_F1X\_064PIN\_PB\_T1\_V1

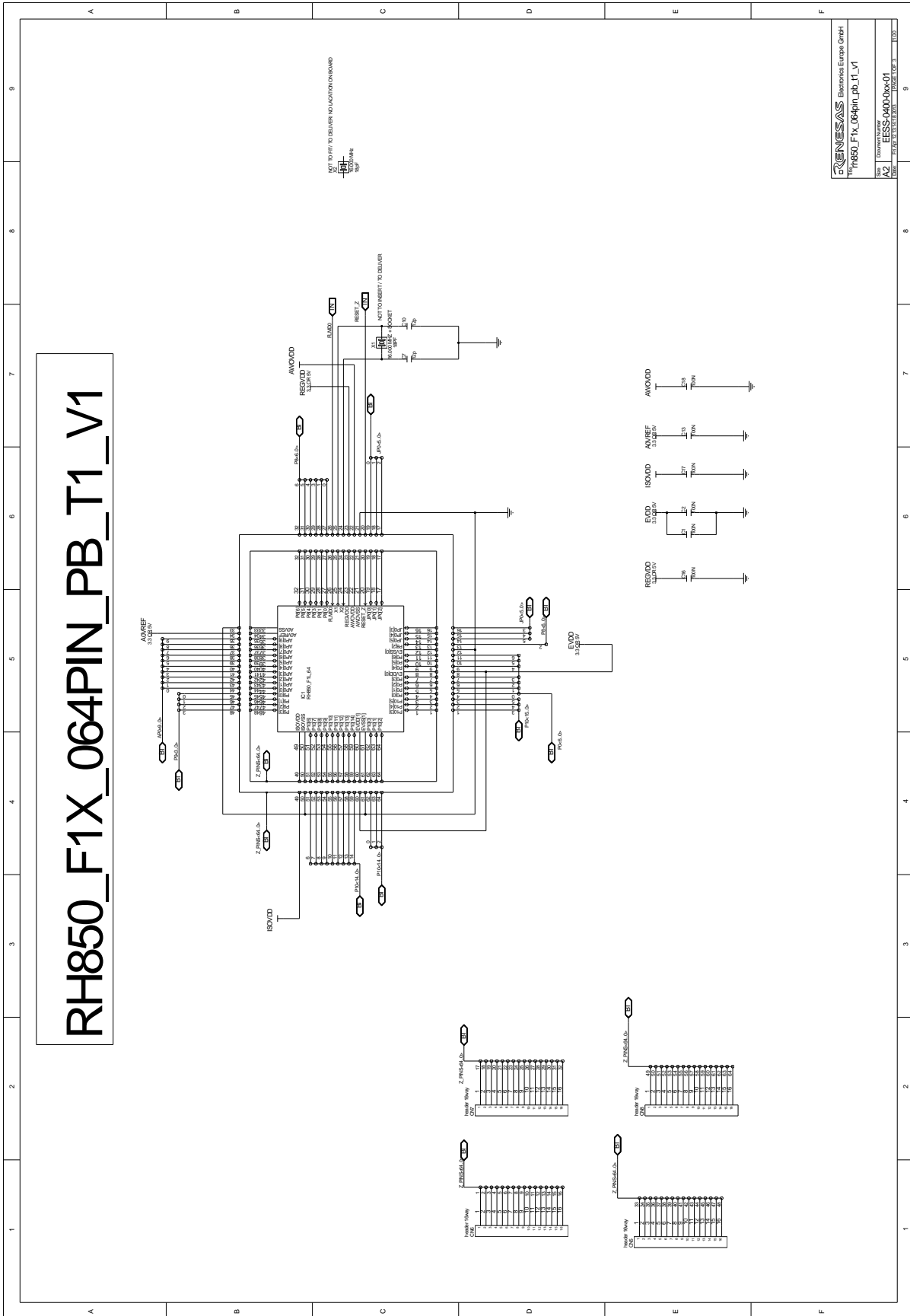

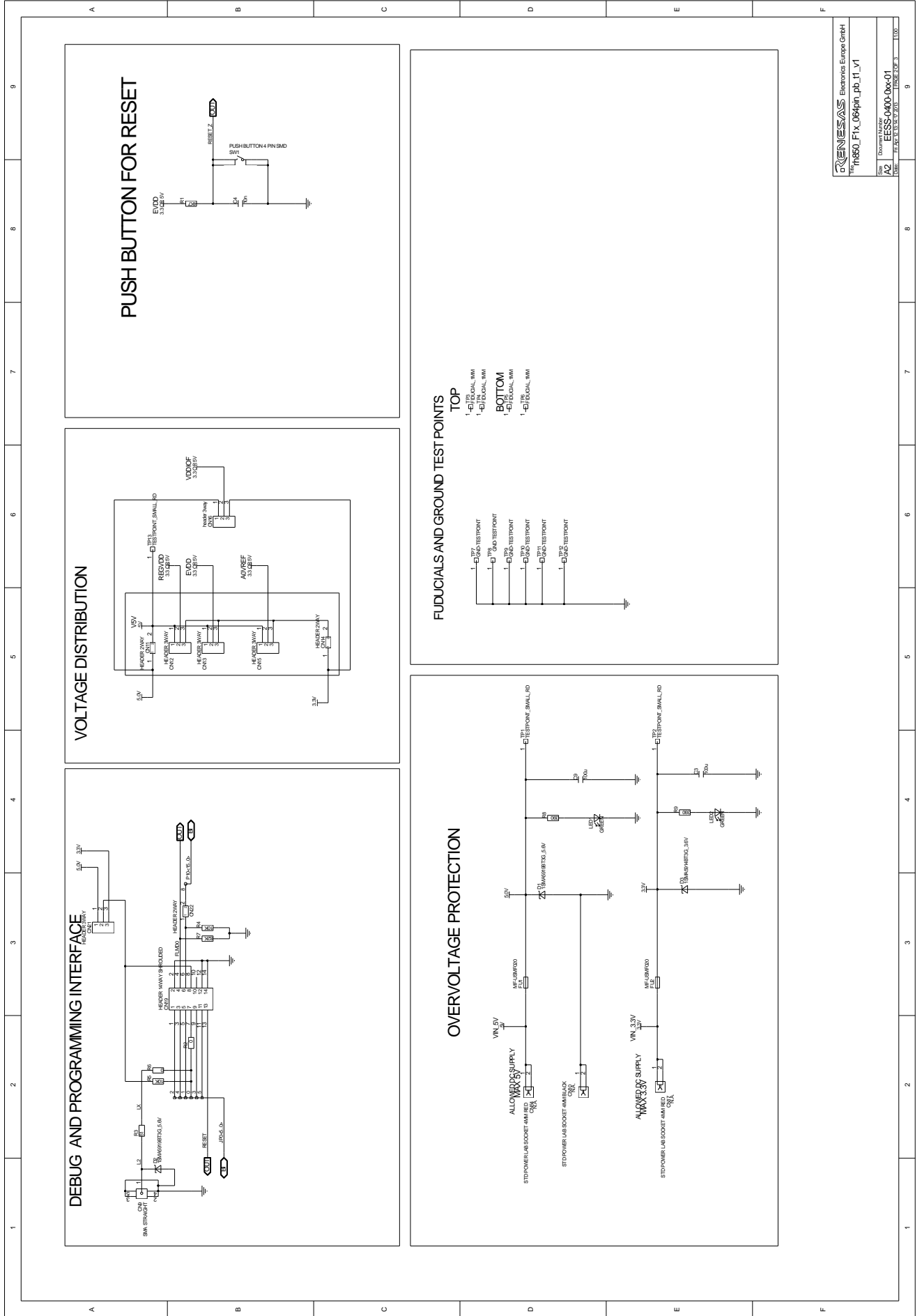

Renesas Electronics Europe GmbH The "R850_Fix_064pin_pb_11_v1"	
Docu. Name	ESS-040-0xx-01
Size	A2
Date	REV. 1.13 (17/2018)
Issue	100

# MAIN BOARD CONNECTORS

CONNECTOR3

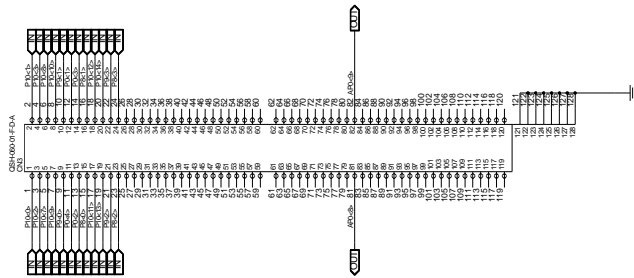

CONNECTOR1

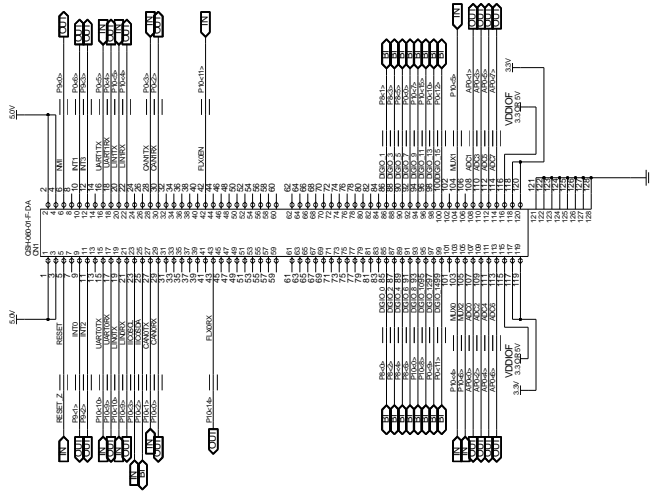

CONNECTOR2

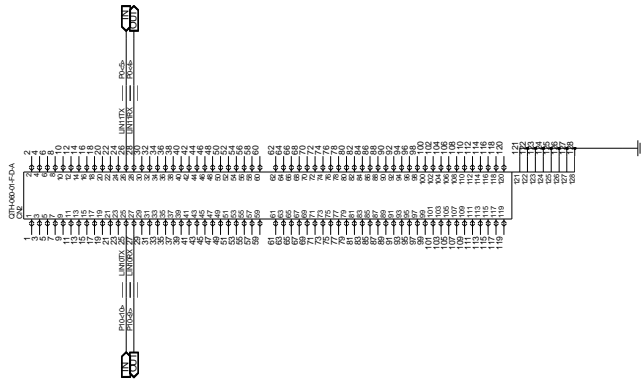

CONNECTOR4

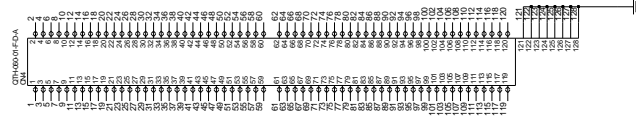

---

## Chapter 9 Revision History

The table provides information about the major changes of the document versions.

Date	Version	Description
2013-11-05	1.0	Initial release
2014-06-10	1.1	Updated cover page
2015-10-21	1.2	Updated schematic for improved readability (same content) Updated description and schematic in chapter 3.2 Updated description of CN19, pin 6, chapter 5
2018-11-23	1.30	Added reference to F1KM-S1 device