

ISL8023EVAL3Z, ISL8024EVAL3Z

Evaluation Board

AN1759  
Rev 1.00  
Sep 10, 2015

**Description**

The ISL8023EVAL3Z, ISL8024EVAL3Z boards are intended for use by individuals with requirements for point-of-load applications sourcing from 2.7V to 5.5V. The ISL8023EVAL3Z, ISL8024EVAL3Z simple smallest factor evaluation boards are used for a quick and easy demonstration of the performance of the [ISL8023](#), [ISL8024](#) low quiescent high efficiency synchronous buck regulator.

The ISL8023 and ISL8024 are offered in a 3mmx3mm 16 Ld TQFN package with 1mm maximum height. The complete area that the converter occupies can be as small as 0.22in<sup>2</sup>.

**Specifications**

PART NUMBER	V <sub>IN</sub> RANGE (V)	V <sub>OUT</sub> RANGE (V)	I <sub>OUT</sub> (MAX) (A)	f <sub>SW</sub> RANGE (MHz)	PART SIZE (2mm)
8023	2.7V to 5.5V		3	Programmable 0.5 to 4MHz	3x3
8024			4		

NOTES:

- The evaluation boards default configuration is V<sub>OUT</sub> = 1.8V, f<sub>SW</sub> = 1MHz (FS tied to V<sub>IN</sub>)
- V<sub>REF</sub> is 0.6V

**Key Features**

- High efficiency synchronous buck regulator with up to 95% efficiency
- 0.8% reference accuracy over temperature/load/line
- Start-up with prebiased output
- Internal soft-start - 1ms or adjustable
- Soft-stop output discharge during disabled
- Adjustable frequency from 500kHz to 4MHz - default at 1MHz
- External synchronization up to 4MHz
- Negative OC protection

**References**

[ISL8023](#), [ISL8024](#) Datasheet

**Ordering Information**

PART NUMBER	DESCRIPTION
ISL8023EVAL3Z	3A low quiescent current high efficiency synchronous buck regulator
ISL8024EVAL3Z	4A low quiescent current high efficiency synchronous buck regulator

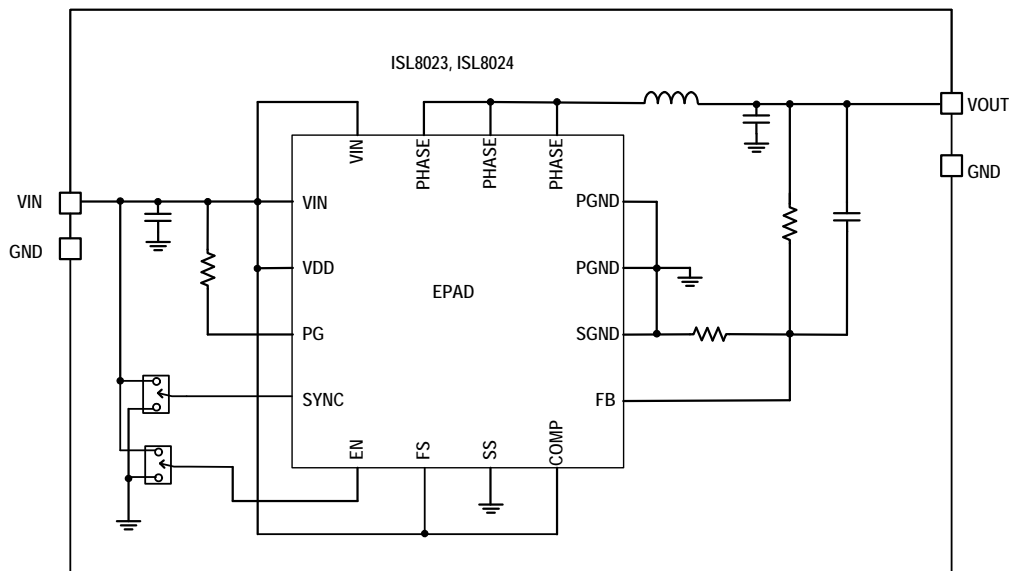

FIGURE 1. BLOCK DIAGRAM

## Recommended Equipment

The following materials are recommended to perform testing:

- 0V to 10V power supply with at least 10A source current capability or 5V battery
- Electronic loads capable of sinking current up to 7A
- Digital Multimeters (DMMs)
- 100MHz quad-trace oscilloscope
- Signal generator

## Quick Setup Guide

1. Ensure that the circuit is correctly connected to the supply and loads prior to applying any power.
2. Connect the bias supply to  $V_{IN}$ , the plus terminal to  $V_{IN}$ , P4 and the negative return to PGND, P5.
3. Connect the output load to  $V_{OUT}$ , the plus terminal to  $V_{OUT}$ , P3 and the negative return to PGND, P7.
4. Verify that the position is PWM for SW2.
5. Verify that the position is ON for SW1.
6. Turn on the power supply.
7. Verify the output voltage is 1.8V for  $V_{OUT}$ .

## Evaluating the Other Output Voltage

The ISL8023EVAL3Z, ISL8024EVAL3Z board output is preset to 1.8V for  $V_{OUT}$ , however, output voltages can be adjusted from 0.6V to 5V. The output voltage programming resistor,  $R_1$ , will depend on the desired output voltage of the regulator. The value for the feedback resistor is typically between  $0\Omega$  and  $200k\Omega$ , as shown in [Equation 1](#).

$$R_2 = R_1 \left( \frac{V_{FB}}{V_{OUT} - V_{FB}} \right) \quad (\text{EQ. 1})$$

If the output voltage desired is 0.6V, then  $R_2$  is left unpopulated and  $R_1$  is shorted. For faster response performance, add 10pF to 47pF in parallel to  $R_1$ . Check bode plot to insure optimum performance.

## Frequency Control

The ISL8023, ISL8024 has an FS pin that controls the frequency of operation. Programmable frequency allows for optimization between efficiency and external component size. Default switching frequency is 1MHz when FS is tied to  $V_{IN}$  ( $R_{11} = 0$  and  $R_{12}$  is open). By connecting  $R_{12}$  to GND, the switching frequency could be changed from 500kHz ( $R_{12} = 426k$ ) to 4MHz ( $R_{12} = 40k$ ) according to [Equation 2](#):

$$R_T[k\Omega] = \frac{220 \cdot 10^3}{f_{OSC}[kHz]} - 14 \quad (\text{EQ. 2})$$

When using  $R_{12}$  to adjust the operational frequency, this also sets external compensation mode. Please refer to the [ISL8023](#), [ISL8024](#) datasheet for more details.

## Soft-start Control

Short CSS to SGND for internal soft-start (approximately 1ms). Populate CSS to adjust the soft-start time. This capacitor, along with an internal 1.6 $\mu$ A current source, sets the soft-start interval of the converter,  $t_{SS}$ .

$$CSS[\mu F] = 3.33 \cdot t_{SS}[s] \quad (\text{EQ. 3})$$

CSS must be less than 33nF to insure proper soft-start reset after fault condition.

## Switches Control

The ISL8023, ISL8024 evaluation boards contain SW1 and SW2 for various controls of the ISL8023, ISL8024 circuitries. [Table 1](#) details this function.

TABLE 1. SWITCH SETTINGS

SW1	ENABLE	FUNCTION
1	OFF	Disable $V_{OUT}$
3	ON	Enable $V_{OUT}$
SW2	MODE	FUNCTION
1	PWM	Fixed PWM frequency at light load
3	PFM	Force continuous mode

## ISL8023EVAL3Z and ISL8024EVAL3Z Evaluation Boards



FIGURE 2. ISL8023EVAL3Z TOP



FIGURE 3. ISL8023EVAL3Z BOTTOM



FIGURE 4. ISL8024EVAL3Z TOP



FIGURE 5. ISL8024EVAL3Z BOTTOM

# ISL8023EVAL3Z, ISL8024EVAL3Z Schematic

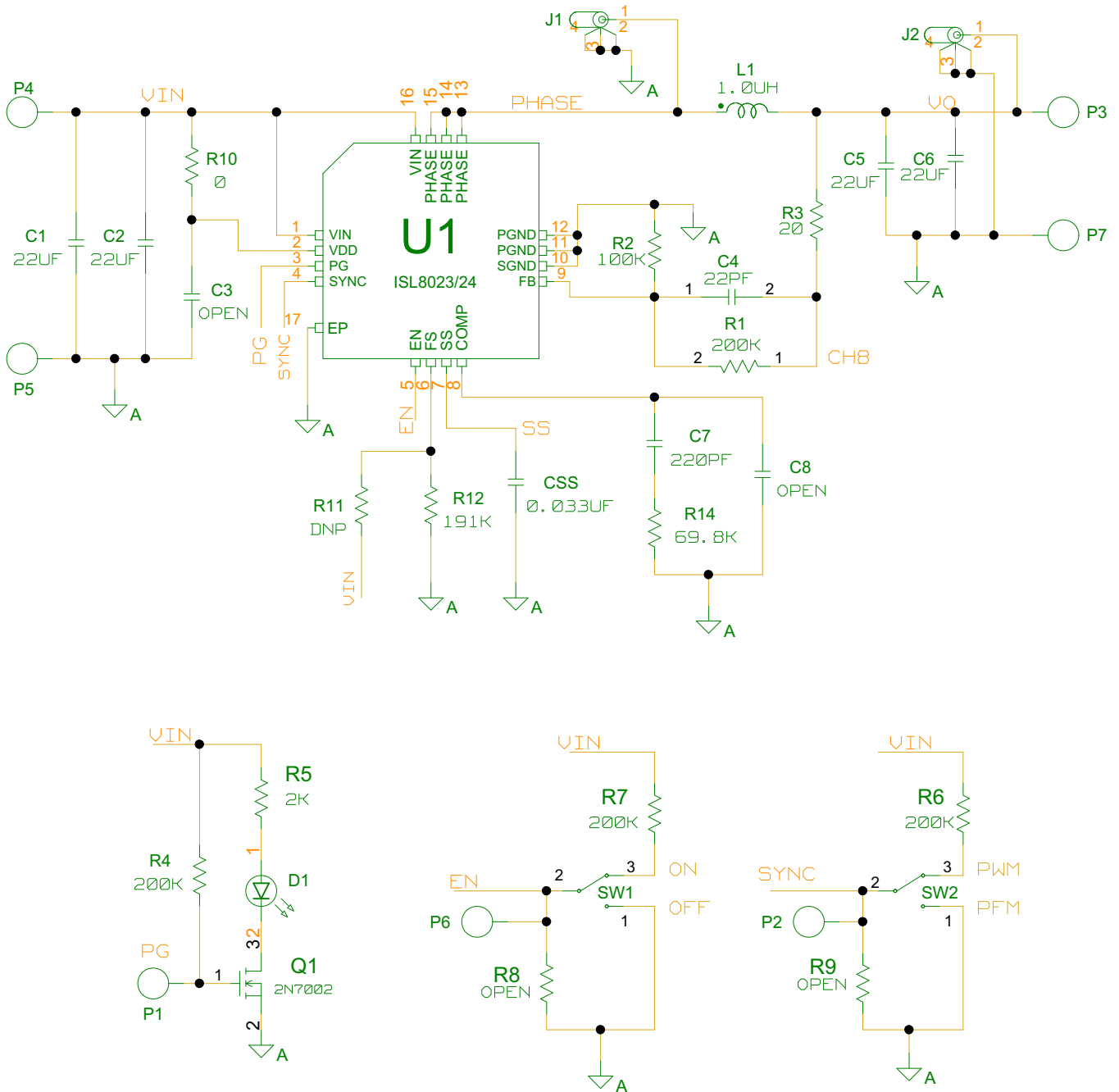

FIGURE 6. SCHEMATIC

TABLE 2. BILL OF MATERIALS

MANUFACTURER PART	QTY	UNITS	REFERENCE DESIGNATOR	DESCRIPTION	MANUFACTURER
ISL8023_24EVAL3ZREVAPCB	1	ea.		PWB-PCB, ISL8023_24EVAL3Z, REVA, ROHS	
C0603C0G500-220JNE	1	ea.	C4	CAP, SMD, 0603, 22pF, 50V, 5%, COG, ROHS	VENKEL
GRM188R71H221KA01D	1	ea.	C7	CAP, SMD, 0603, 220pF, 50V, 10%, X7R, ROHS	MURATA
C0603X7R160-333KNE	1	ea.	CSS	CAP, SMD, 0603, 33000pF, 16V, 10%, X7R, ROHS	VENKEL
	0	ea.	C3, C8	CAP, SMD, 0603, DNP-PLACE HOLDER, ROHS	
GRM31CR60J226KE19L	2	ea.	C2, C5	CAP, SMD, 1206, 22μF, 6.3V, 10%, X5R, ROHS	MURATA
	0	ea.	C1, C6	CAP, SMD, 1206, DNP-PLACE HOLDER, ROHS	
DR73-1R0-R	1	ea.	L1	COIL-PWR INDUCTOR, SMD, 7.6mm, 1.0μH, 20%, 5.28A, ROHS, SHIELDED	COOPER ELECTRONIC TECH.
131-4353-00	2	ea.	J1, J2	CONN-SCOPE PROBE TEST PT, COMPACT, PCB MNT, ROHS	TEKTRONIX
1514-2	4	ea.	P4, P5, P7, P8	CONN-TURRET, TERMINAL POST, TH, ROHS	KEYSTONE
5002	3	ea.	P1, P2, P6	CONN-MINI TEST POINT, VERTICAL, WHITE, ROHS	KEYSTONE
LTST-C170CKT	1	ea.	D1	LED-GaAs RED, SMD, 2x1.25mm, 100mW, 40mA, 10mcd, ROHS	LITEON/VISHAY
ISL8023/24IRZ	1	ea.	U1	IC-3A/4A BUCK REGULATOR, 16P, QFN, 3x3, ROHS	INTERSIL
2N7002-7-F	1	ea.	Q1	TRANSISTOR, N-CHANNEL, 3 LD, SOT-23, 60V, 115mA, ROHS	DIODES, INC.
	0	ea.	R11	RESISTOR, SMD, 0603, 0.1%, MF, DNP-PLACE HOLDER	
ERJ-3EKF20R0V	1	ea.	R3	RES, SMD, 0603, 20Ω, 1/10W, 1%, TF, ROHS	PANASONIC
CR0603-10W-000T	1	ea.	R10	RES, SMD, 0603, 0Ω, 1/10W, TF, ROHS	VENKEL
CR0603-10W-1003FT	2	ea.	R2, R14	RES, SMD, 0603, 100k, 1/10W, 1%, TF, ROHS	VENKEL
CR-0603-10W-1913FT	1	ea.	R12	RES, SMD, 0603, 191k, 1/10W, 1%, TF, ROHS	VENKEL
CR0603-10W-2003FT	4	ea.	R1, R4, R6, R7	RES, SMD, 0603, 200k, 1/10W, 1%, TF, ROHS	VENKEL
	0	ea.	R5, R8, R9	RES, SMD, 0603, DNP-PLACE HOLDER, ROHS	
GT11MSCBE	2	ea.	SW1, SW2	SWITCH-TOGGLE, SMD, 6 PIN, SPDT, 2POS, ON-ON, ROHS	ITT INDUSTRIES/C&K DIVISION
	0	ea.	P3 (3VH30/1JN5)	DO NOT POPULATE OR PURCHASE	

# ISL8023EVAL3Z, ISL8024EVAL3Z Board Layout

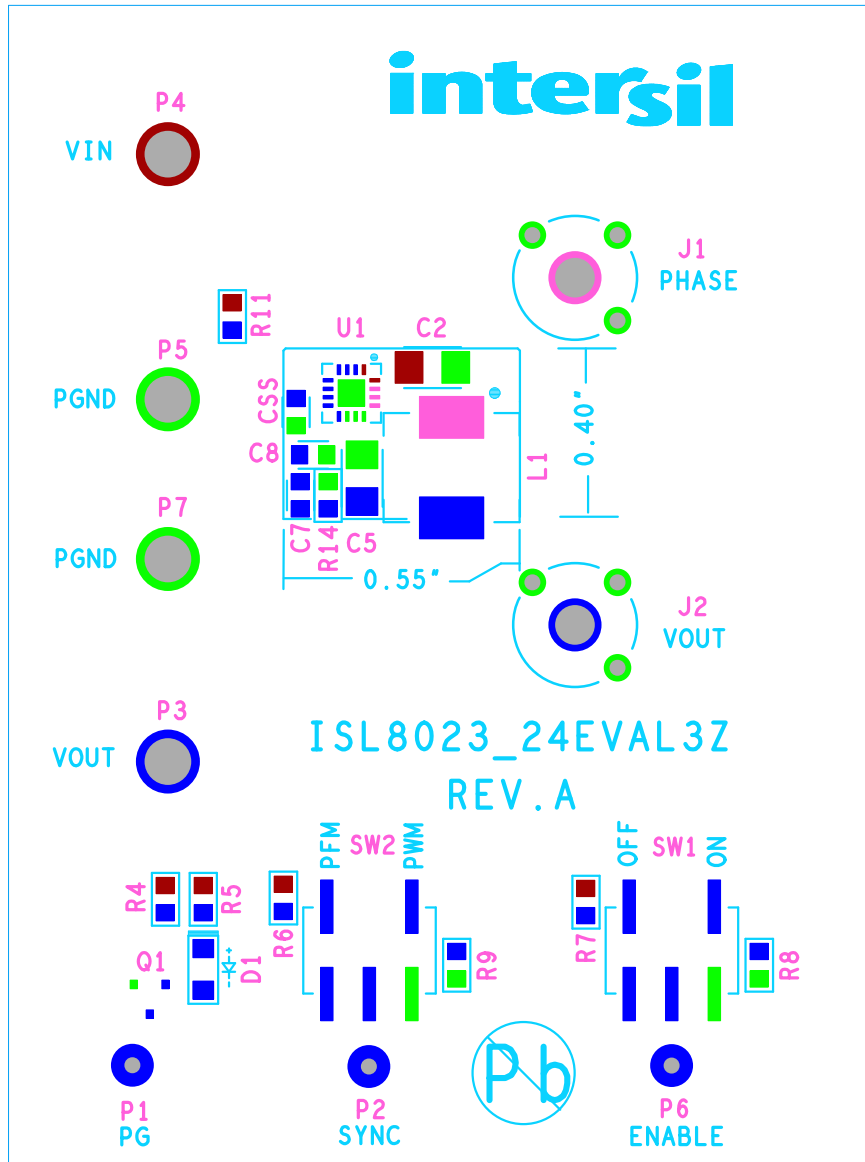

FIGURE 7. TOP LAYER COMPONENTS

# ISL8023EVAL3Z, ISL8024EVAL3Z Board Layout (Continued)

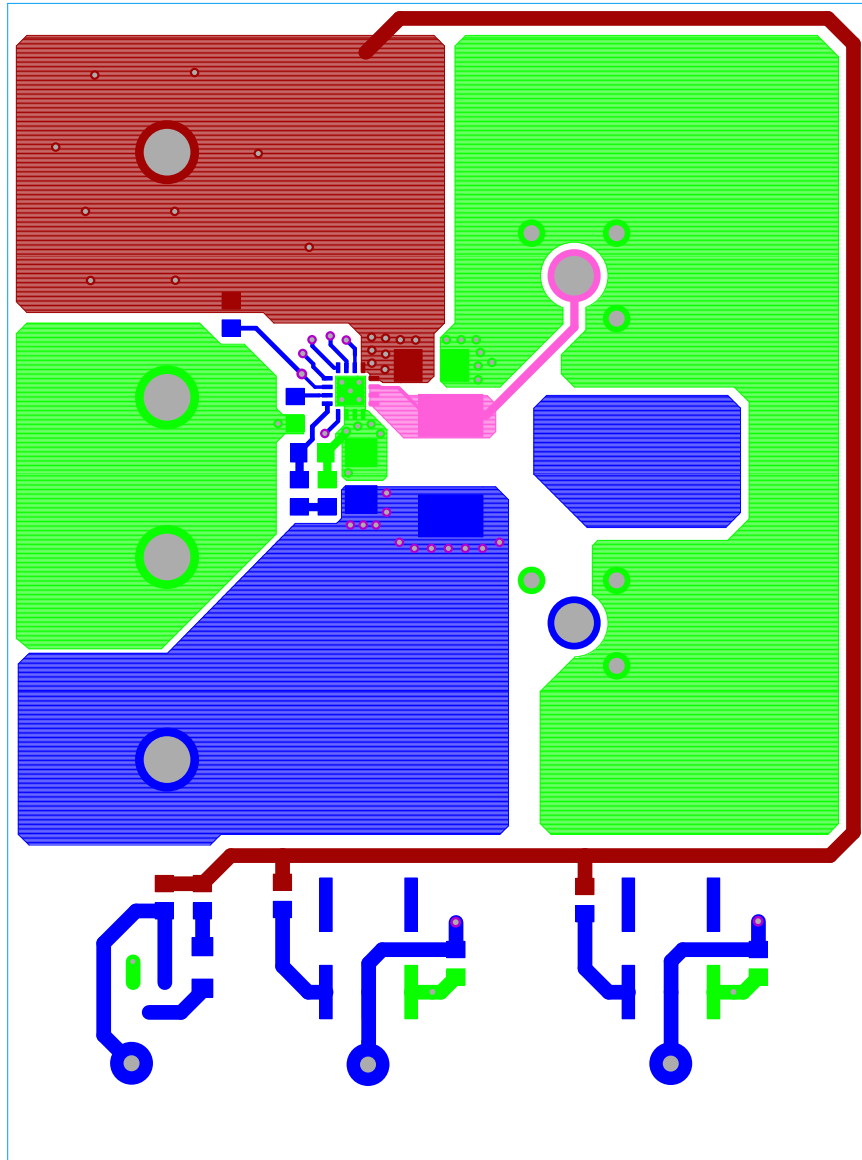

FIGURE 8. TOP LAYER ETCH

**ISL8023EVAL3Z, ISL8024EVAL3Z Board Layout** (Continued)

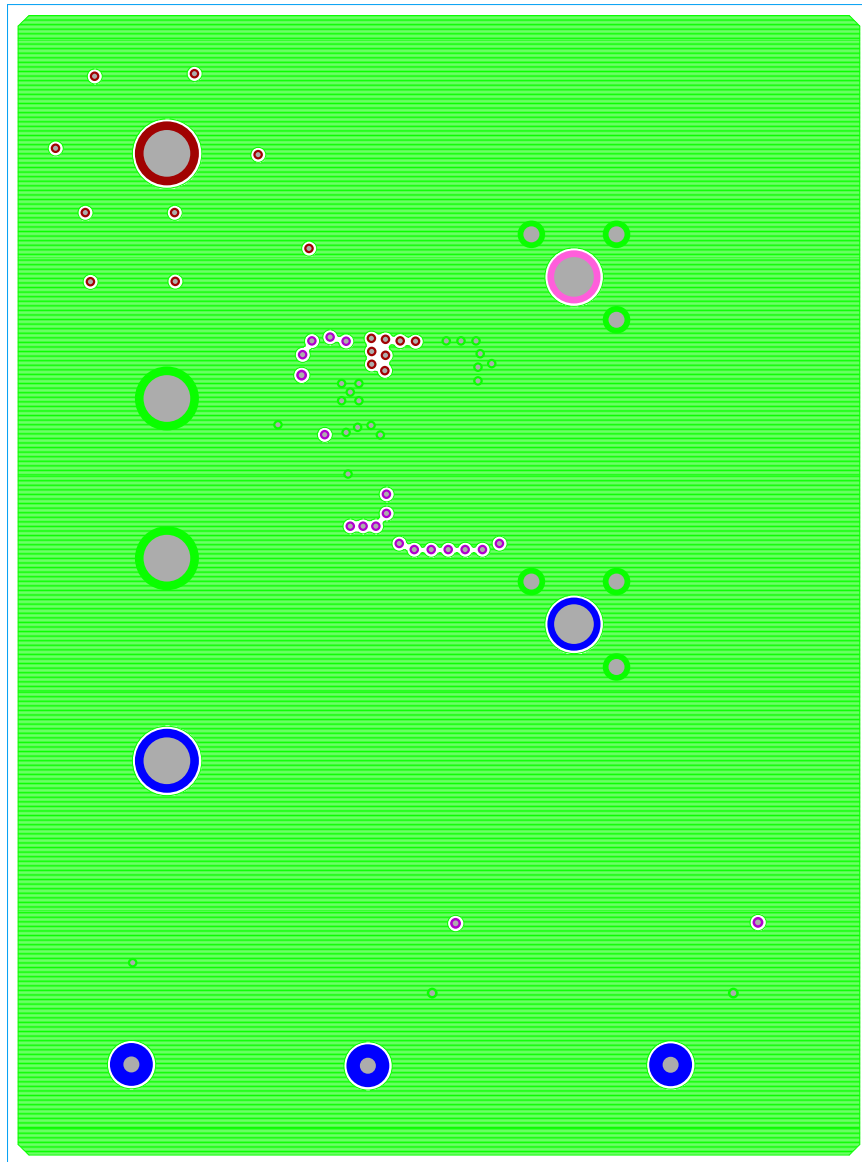

FIGURE 9. SECOND LAYER ETCH



**ISL8023EVAL3Z, ISL8024EVAL3Z Board Layout** (Continued)

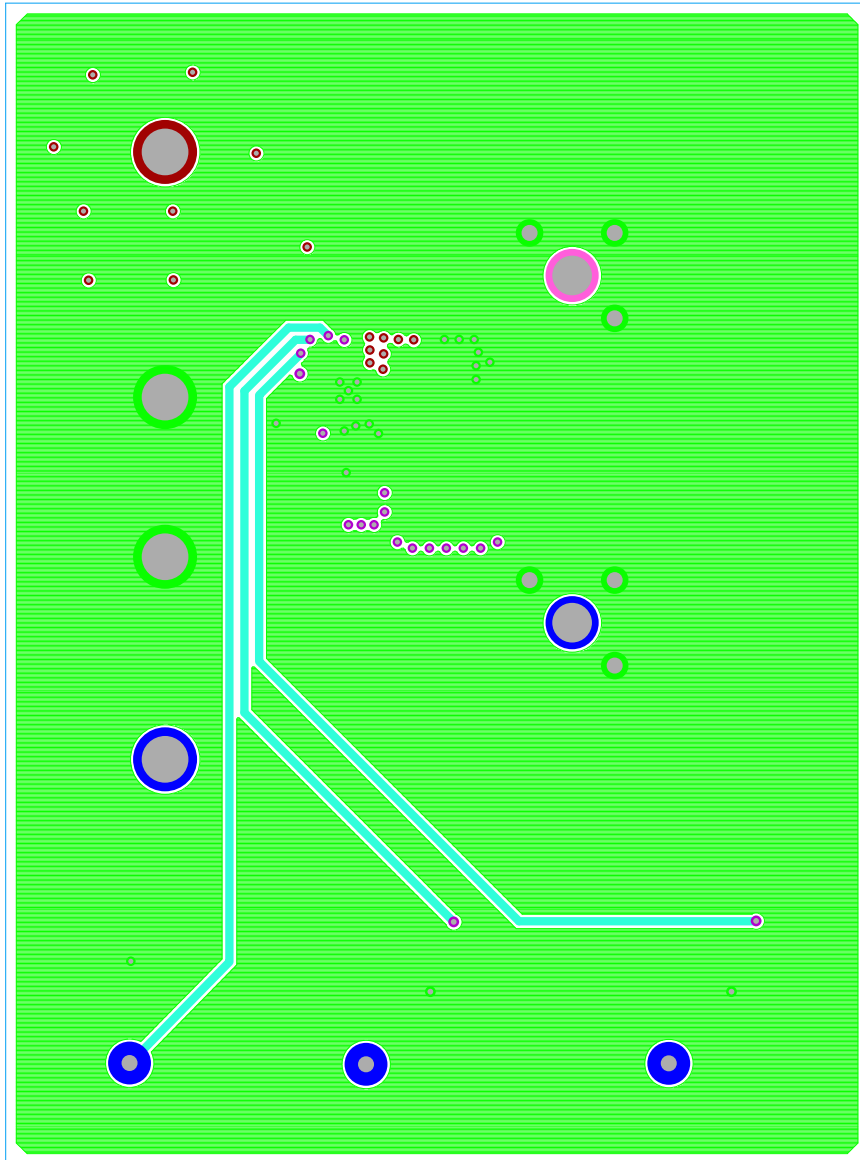

FIGURE 10. THIRD LAYER ETCH

## ISL8023EVAL3Z, ISL8024EVAL3Z Board Layout (Continued)

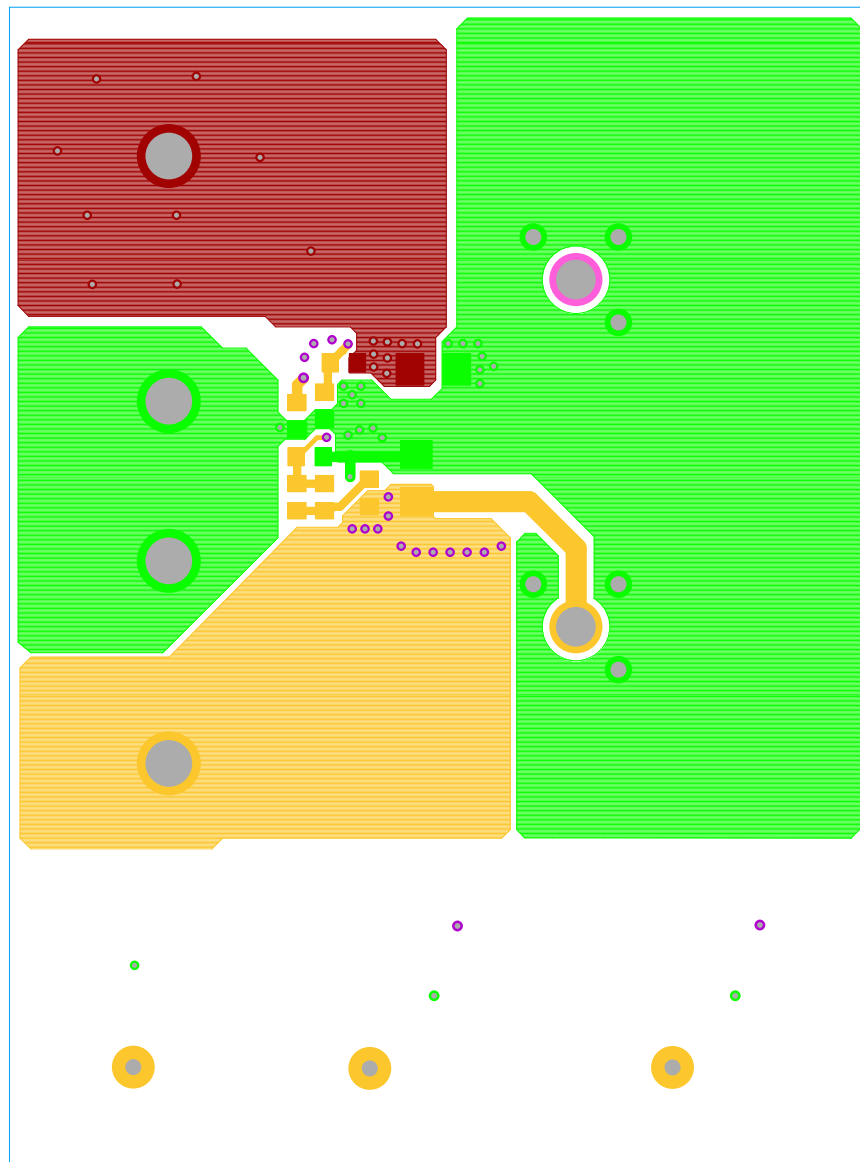

FIGURE 11. BOTTOM LAYER ETCH

## ISL8023EVAL3Z, ISL8024EVAL3Z Board Layout (Continued)

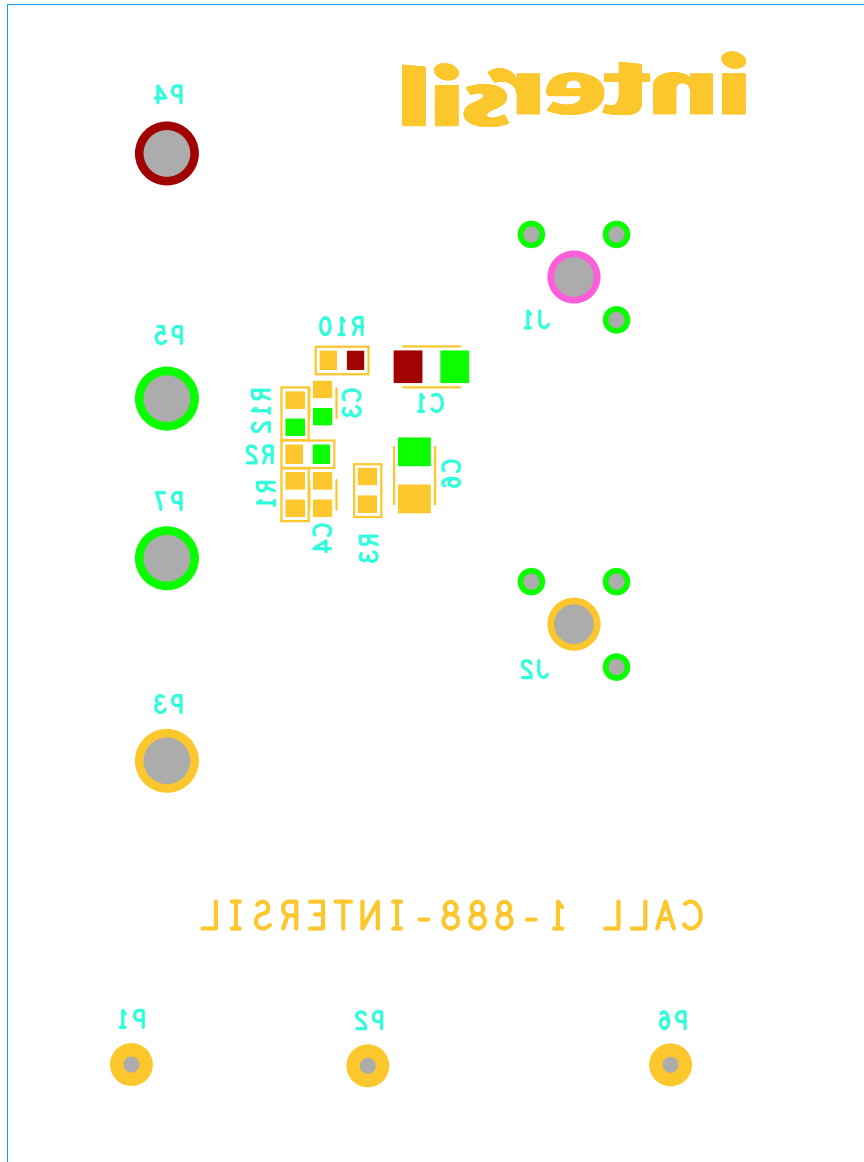

FIGURE 12. BOTTOM LAYER COMPONENTS

## Notice

1. Descriptions of circuits, software and other related information in this document are provided only to illustrate the operation of semiconductor products and application examples. You are fully responsible for the incorporation or any other use of the circuits, software, and information in the design of your product or system. Renesas Electronics disclaims any and all liability for any losses and damages incurred by you or third parties arising from the use of these circuits, software, or information.
2. Renesas Electronics hereby expressly disclaims any warranties against and liability for infringement or any other claims involving patents, copyrights, or other intellectual property rights of third parties, by or arising from the use of Renesas Electronics products or technical information described in this document, including but not limited to, the product data, drawings, charts, programs, algorithms, and application examples.
3. No license, express, implied or otherwise, is granted hereby under any patents, copyrights or other intellectual property rights of Renesas Electronics or others.
4. You shall not alter, modify, copy, or reverse engineer any Renesas Electronics product, whether in whole or in part. Renesas Electronics disclaims any and all liability for any losses or damages incurred by you or third parties arising from such alteration, modification, copying or reverse engineering.
5. Renesas Electronics products are classified according to the following two quality grades: "Standard" and "High Quality". The intended applications for each Renesas Electronics product depends on the product's quality grade, as indicated below.  
"Standard": Computers; office equipment; communications equipment; test and measurement equipment; audio and visual equipment; home electronic appliances; machine tools; personal electronic equipment; industrial robots; etc.  
"High Quality": Transportation equipment (automobiles, trains, ships, etc.); traffic control (traffic lights); large-scale communication equipment; key financial terminal systems; safety control equipment; etc.  
Unless expressly designated as a high reliability product or a product for harsh environments in a Renesas Electronics data sheet or other Renesas Electronics document, Renesas Electronics products are not intended or authorized for use in products or systems that may pose a direct threat to human life or bodily injury (artificial life support devices or systems; surgical implantations; etc.), or may cause serious property damage (space system; undersea repeaters; nuclear power control systems; aircraft control systems; key plant systems; military equipment; etc.). Renesas Electronics disclaims any and all liability for any damages or losses incurred by you or any third parties arising from the use of any Renesas Electronics product that is inconsistent with any Renesas Electronics data sheet, user's manual or other Renesas Electronics document.
6. When using Renesas Electronics products, refer to the latest product information (data sheets, user's manuals, application notes, "General Notes for Handling and Using Semiconductor Devices" in the reliability handbook, etc.), and ensure that usage conditions are within the ranges specified by Renesas Electronics with respect to maximum ratings, operating power supply voltage range, heat dissipation characteristics, installation, etc. Renesas Electronics disclaims any and all liability for any malfunctions, failure or accident arising out of the use of Renesas Electronics products outside of such specified ranges.
7. Although Renesas Electronics endeavors to improve the quality and reliability of Renesas Electronics products, semiconductor products have specific characteristics, such as the occurrence of failure at a certain rate and malfunctions under certain use conditions. Unless designated as a high reliability product or a product for harsh environments in a Renesas Electronics data sheet or other Renesas Electronics document, Renesas Electronics products are not subject to radiation resistance design. You are responsible for implementing safety measures to guard against the possibility of bodily injury, injury or damage caused by fire, and/or danger to the public in the event of a failure or malfunction of Renesas Electronics products, such as safety design for hardware and software, including but not limited to redundancy, fire control and malfunction prevention, appropriate treatment for aging degradation or any other appropriate measures. Because the evaluation of microcomputer software alone is very difficult and impractical, you are responsible for evaluating the safety of the final products or systems manufactured by you.
8. Please contact a Renesas Electronics sales office for details as to environmental matters such as the environmental compatibility of each Renesas Electronics product. You are responsible for carefully and sufficiently investigating applicable laws and regulations that regulate the inclusion or use of controlled substances, including without limitation, the EU RoHS Directive, and using Renesas Electronics products in compliance with all these applicable laws and regulations. Renesas Electronics disclaims any and all liability for damages or losses occurring as a result of your noncompliance with applicable laws and regulations.
9. Renesas Electronics products and technologies shall not be used for or incorporated into any products or systems whose manufacture, use, or sale is prohibited under any applicable domestic or foreign laws or regulations. You shall comply with any applicable export control laws and regulations promulgated and administered by the governments of any countries asserting jurisdiction over the parties or transactions.
10. It is the responsibility of the buyer or distributor of Renesas Electronics products, or any other party who distributes, disposes of, or otherwise sells or transfers the product to a third party, to notify such third party in advance of the contents and conditions set forth in this document.
11. This document shall not be reprinted, reproduced or duplicated in any form, in whole or in part, without prior written consent of Renesas Electronics.
12. Please contact a Renesas Electronics sales office if you have any questions regarding the information contained in this document or Renesas Electronics products.  
(Note 1) "Renesas Electronics" as used in this document means Renesas Electronics Corporation and also includes its directly or indirectly controlled subsidiaries.  
(Note 2) "Renesas Electronics product(s)" means any product developed or manufactured by or for Renesas Electronics.

(Rev.4.0-1 November 2017)



### SALES OFFICES

Renesas Electronics Corporation

<http://www.renesas.com>

Refer to "<http://www.renesas.com/>" for the latest and detailed information.

**Renesas Electronics America Inc.**  
1001 Murphy Ranch Road, Milpitas, CA 95035, U.S.A.  
Tel: +1-408-432-8888, Fax: +1-408-434-5351

**Renesas Electronics Canada Limited**  
9251 Yonge Street, Suite 8309 Richmond Hill, Ontario Canada L4C 9T3  
Tel: +1-905-237-2004

**Renesas Electronics Europe Limited**  
Dukes Meadow, Millboard Road, Bourne End, Buckinghamshire, SL8 5FH, U.K  
Tel: +44-1628-651-700, Fax: +44-1628-651-804

**Renesas Electronics Europe GmbH**  
Arcadiastrasse 10, 40472 Düsseldorf, Germany  
Tel: +49-211-6503-0, Fax: +49-211-6503-1327

**Renesas Electronics (China) Co., Ltd.**  
Room 1709 Quantum Plaza, No.27 ZhichunLu, Haidian District, Beijing, 100191 P. R. China  
Tel: +86-10-8235-1155, Fax: +86-10-8235-7679

**Renesas Electronics (Shanghai) Co., Ltd.**  
Unit 301, Tower A, Central Towers, 555 Langao Road, Putuo District, Shanghai, 200333 P. R. China  
Tel: +86-21-2226-0888, Fax: +86-21-2226-0999

**Renesas Electronics Hong Kong Limited**  
Unit 1601-1611, 16/F., Tower 2, Grand Century Place, 193 Prince Edward Road West, Mongkok, Kowloon, Hong Kong  
Tel: +852-2265-6688, Fax: +852-2886-9022

**Renesas Electronics Taiwan Co., Ltd.**  
13F, No. 363, Fu Shing North Road, Taipei 10543, Taiwan  
Tel: +886-2-8175-9600, Fax: +886-2-8175-9670

**Renesas Electronics Singapore Pte. Ltd.**  
80 Bendemeer Road, Unit #06-02 Hyflux Innovation Centre, Singapore 339949  
Tel: +65-6213-0200, Fax: +65-6213-0300

**Renesas Electronics Malaysia Sdn.Bhd.**  
Unit 1207, Block B, Menara Amcorp, Amcorp Trade Centre, No. 18, Jln Persiaran Barat, 46050 Petaling Jaya, Selangor Darul Ehsan, Malaysia  
Tel: +60-3-7955-9390, Fax: +60-3-7955-9510

**Renesas Electronics India Pvt. Ltd.**  
No.777C, 100 Feet Road, HAL 2nd Stage, Indiranagar, Bangalore 560 038, India  
Tel: +91-80-67208700, Fax: +91-80-67208777

**Renesas Electronics Korea Co., Ltd.**  
17F, KAMCO Yangjae Tower, 262, Gangnam-daero, Gangnam-gu, Seoul, 06265 Korea  
Tel: +82-2-558-3737, Fax: +82-2-558-5338